

GOVERNMENT OF INDIA

ARCHAEOLOGICAL SURVEY OF INDIA

CENTRAL
ARCHAEOLOGICAL
LIBRARY

ACCESSION NO. 33800

CALL No. 913.3937/G.L.S.W.

v.1

D.G.A. 79.

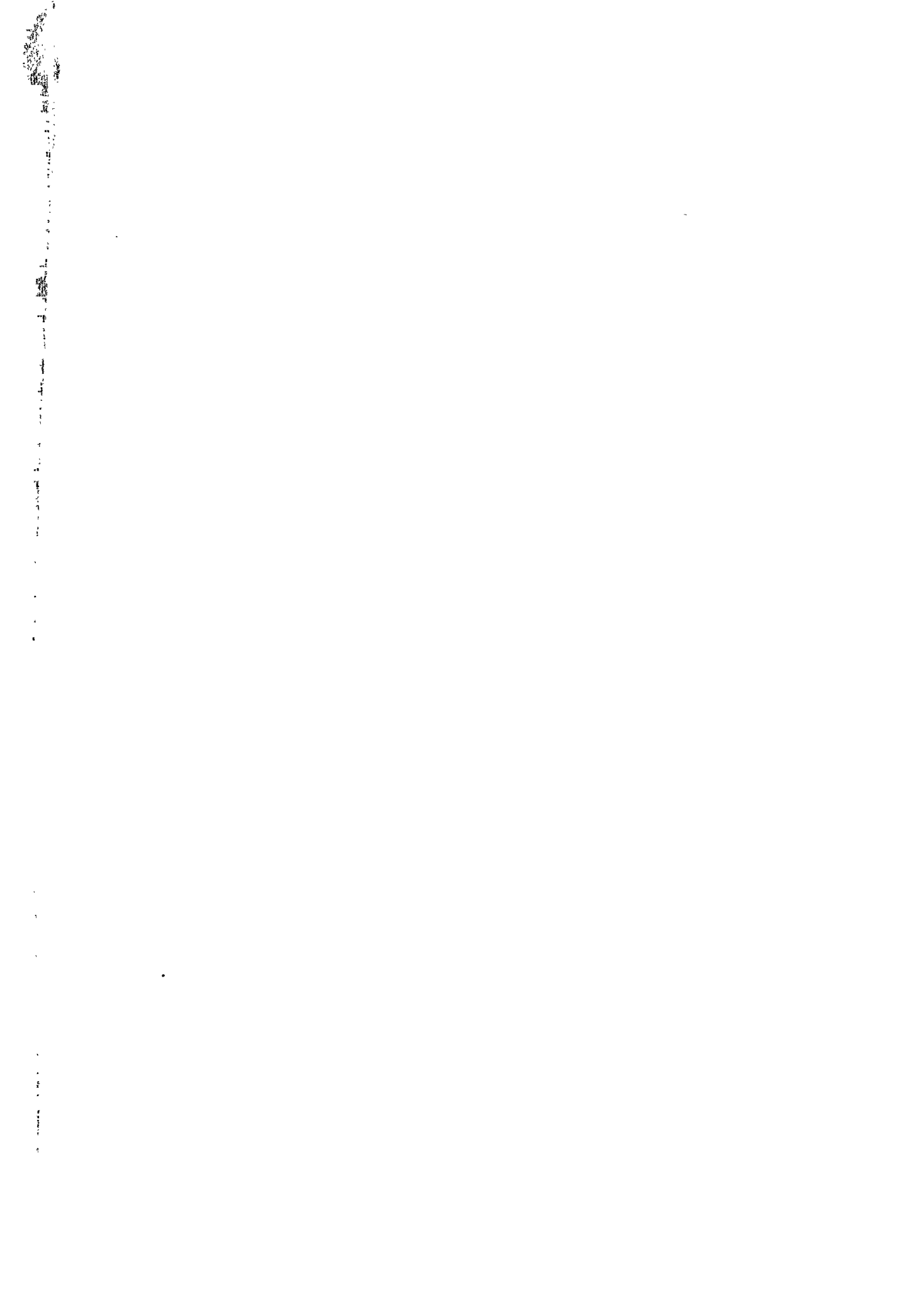

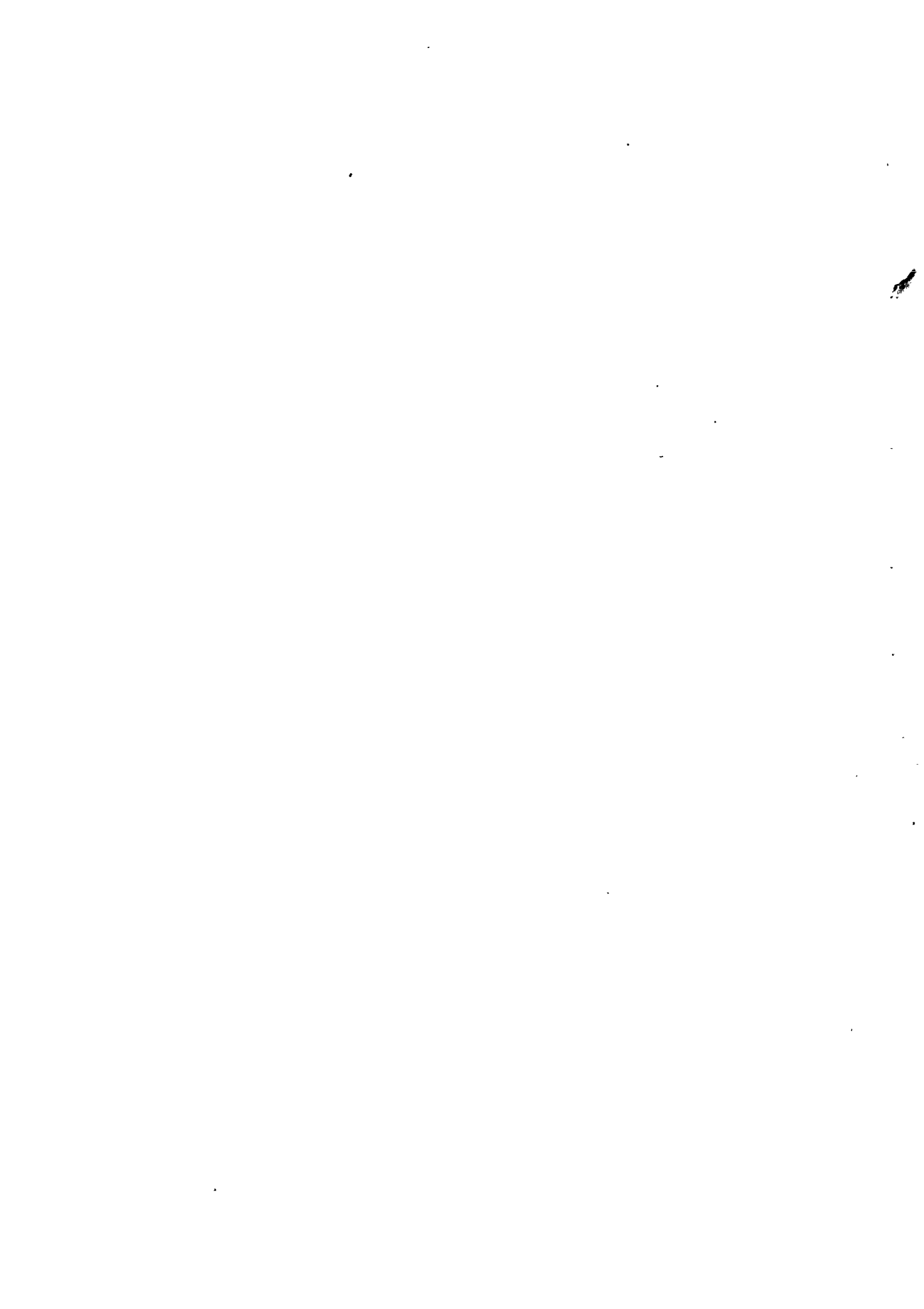

THE SWEDISH CYPRUS EXPEDITION

FINDS AND RESULTS OF THE
EXCAVATIONS IN CYPRUS

1927—1931

Vol. I (Text)

VOL. I. TEXT

BY

EINAR GJERSTAD

JOHN LINDROS

ERIK SJÖQVIST

ALFRED WESTHOLM

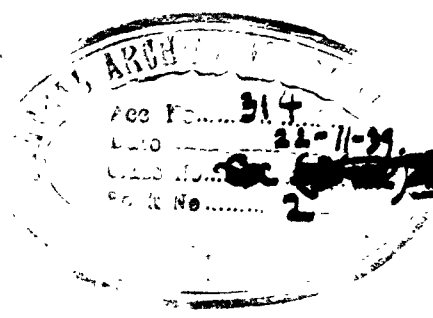

913. 2914
gkl.

THE SWEDISH CYPRUS EXPEDITION
STOCKHOLM

CENTRAL ARCHAEOLOGICAL
LIBRARY, NEW DELHI.

Acc. No. 33800
Date 13.5.58
Call No. 913.3937

G.L.S.W.

COPYRIGHT BY THE SWEDISH CYPRUS EXPEDITION
STOCKHOLM

PRINTED BY
VICTOR PETTERSONS BOKINDUSTRIAKTIEBOLAG
STOCKHOLM 1934

*TO THE LADIES
OF THE EXPEDITION*

~~1845~~

2

S U B S C R I B E R S

H. R. H. THE CROWN PRINCE OF SWEDEN

H. R. H. PRINCE EUGEN

AHLGREN, ADOLF
Gävle, Sweden

ARCHÄOLOGISCHES SEMINAR
Munchen, Germany

AKADEMISCHES KUNSTMUSEUM
Bonn, Germany

ARCHBISHOPRIC OF CYPRUS
Nicosia, Cyprus

ALLARD PIERSON STICHTING
Amsterdam, Holland

ARONSSON, SVEN
Stockholm, Sweden

ALMGREN, BERTIL
Stockholm, Sweden

ASHMOLEAN MUSEUM
Oxford, England

AMERICAN SCHOOL OF CLASSICAL STUDIES
Athens, Greece

BAER & CO., JOSEPH
Frankfurt a. M., Germany

ÅQVIST, ERIK
Örebro, Sweden

BAYERISCHE STAATS-BIBLIOTHEK
Munchen, Germany

ÅQVIST, ERNST
Örebro, Sweden

BENNET, C. FR.
Stockholm, Sweden

ÅQVIST, TORSTEN
Örebro, Sweden

BERGSKA INSTITUTET
Stockholm, Sweden

ARCHÄOLOGISCHES INSTITUT DER
UNIVERSITÄT
Halle a. S., Germany

BERGSTEN, KARL
Stockholm, Sweden

ARCHÄOLOGISCHES INSTITUT DER
UNIVERSITÄT
Leipzig, Germany

BERNSTRÖM, GUSTAF
Goteborg, Sweden

ARCHÄOLOGISCHES INSTITUT DER
UNIVERSITÄT
Tubingen, Germany

BIBLIOTHÈQUE DE L'ÉCOLE FRANÇAISE
D'ARCHÉOLOGIE
Athènes, Greece

BIBLIOTHÈQUE DE L'UNIVERSITÉ DE
NANCY
Nancy, France

ARCHÄOLOGISCHES SEMINAR DER
UNIVERSITÄT
Berlin, Germany

BIBLIOTEKA JAGIELLONSKA
Krakowie, Poland

BILLBERGS BOKHANDEL
Stockholm, Sweden

BLISS, ROBERT WOODS
Georgetown, U. S. A.

BOETHIUS, AXEL
Goteborg, Sweden

BONNIER, ALBERT
Stockholm, Sweden

BORIN, GUSTAF
Goteborg, Sweden

BRITISH MUSEUM
London, England

BRUCE, J. L.
Nicosia, Cyprus

BUSH COLLECTION OF RELIGION AND
CULTURE
Columbia University, New York, U. S. A.

CARLSSON, DAGMAR
Örebro, Sweden

CITY OF BIRMINGHAM PUBLIC LIBRARIES
Birmingham, England

CLEVELAND PUBLIC LIBRARY
Cleveland, U. S. A.

COLLETT, C. ALB.
Stockholm, Sweden

COOPER, BARBARA V.
Derby, England

COUREAS, MILTIADES
Nicosia, Cyprus

COYET, HENRIETTE
Torup, Sweden

CUFF, C. CH.
Nicosia, Cyprus

DAHLIN, HARALD
Djursholm, Sweden

DARTMOUTH COLLEGE LIBRARY
Hannover, U. S. A.

DEHILGREN, S.
Stockholm, Sweden

DEIGHTON, BELL & CO., LTD.
Cambridge, England

DEPARTMENT OF ANTIQUITIES
Jerusalem, Palestine

DEUTSCHE FORSCHUNGSGEMEINSCHAFT
Berlin, Germany

DEUTSCHES ARCHÄOLOGISCHES INSTITUT
Athen, Greece

DEUTSCHES ARCHÄOLOGISCHES INSTITUT
Istanbul, Turkey

DIREZIONE GENERALE DEI MUSEI E
GALLERIE PONTIFICIE
Città del Vaticano

ECKART—BUCHHANDLUNG
Wien, Austria

EIDEM, ERLING
Uppsala, Sweden

EKMAN, CARL E.
Visby, Sweden

ENGSTRÖMER, THORE
Uppsala, Sweden

ERIKSSON, ESKIL
Vanersborg, Sweden

EUMORFOPOULOS, G.
London, England

FOGELBERG, BIRGER
Gävle, Sweden

FREDRIKSON, V.
Stockholm, Sweden

FRISK, CARL
Stockholm, Sweden

FRITZES KUNGL. HOFBOKHANDEL, C. E., A.-B.
Stockholm, Sweden

GABRIELSSON, A.
Göteborg, Sweden

GAFFIERO, JOSEPH CLAUDIO
Nicosia, Cyprus

GEMEENTEBIBLIOTHEEK
Rotterdam, Holland

VON GERBER, C. W.
Alexandria, Egypt

GOLDSTON, EDWARD, LTD.
London, England

GRAFSTRÖM, ESKIL
Stockholm, Sweden

GUNNIS, RUPERT
Nicosia, Cyprus

HÄCKNER, YNGVE
Neglinge, Sweden

H.ÆGGSTRÖM, CARL Z.
Uppsala, Sweden

HANNER, KURT
Storängen, Sweden

HEISS, FR.
Stockholm, Sweden

HELLSTRÖM, ANDERS
Molndal, Sweden

HOST & SON, ANDR. FRED.
København, Denmark

HULTMARK, EMIL
Sjogesta, Sweden

HULTMARK, RICHARD
Linköping, Sweden

IMPERIAL LIBRARY
Calcutta, India

INGHOLT, HARALD
Beyrouth, Syria

INSTITUTET FÖR KLASSISK FORNKUNSKAP
Stockholm, Sweden

JACOBSSON, HERBERT
Göteborg, Sweden

JOHNSON, AX:SON, AXEL
Stockholm, Sweden

JONSSON, J. E.
Hedemora, Sweden

KEMINK & ZOON'S SORTIMENT
Utrecht, Holland

KJELLBERG, ERNST
Stockholm, Sweden

KLEIST, ALEXIUS
Stockholm, Sweden

KRANTZ, C. T.
Äppelviken, Sweden

KROON, JOHN
Malmö, Sweden

KUNGLIGA BYGGNADSTYRELSEN
Stockholm, Sweden

KUNGLIGA VITTRERIETS HISTORIE OCH
ANTIKNITETS AKADEMIEN
Stockholm, Sweden

LAGERCRANTZ, GUSTAF
Djursholm, Sweden

LAGERCRANTZ, OTTO
Uppsala, Sweden

LAGRELIUS, AXEL
Stockholm, Sweden

LANGENSKIÖLD, CARL GUSTAF
Stockholm, Sweden

LANGENSKIÖLD, ERIC
Stockholm, Sweden

LARSSON, L. E.
Uppsala, Sweden

LAURIN, THORSTEN
Stockholm, Sweden

LEVIN & MUNKSGAARD
København, Denmark

- LIBRAIRIE L. GOTHIER
Liège, Belgium
- LINDGREN, ADOLF
Örebro, Sweden
- LORENTZ, ALFRED
Leipzig, Germany
- LOUISOU, LOUIS EVANG.
Famagusta, Cyprus
- LUNDEQUISTSKA BOKHANDELN, A.-B.
Uppsala, Sweden
- MALMÖ MUSEUM
Malmö, Sweden
- MÄNSSON, M.
Stockholm, Sweden
- MARTIN VON WAGNER MUSEUM
DER UNIVERSITÄT
Wurzburg, Germany
- MCGILL UNIVERSITY LIBRARY
Montreal, Canada
- METROPOLITAN MUSEUM OF ART
New York, U. S. A.
- MOGABGAB, THEO.
Famagusta, Cyprus
- MUDD, H. S.
Los Angeles, U. S. A.
- MUSEUM OF CLASSICAL ARCHAEOLOGY
Cambridge, England
- NATIONAL LIBRARY OF WALES
Aberystwyth, Wales
- NEWBERRY, PERCY E.
Ightham, England
- NEW YORK PUBLIC LIBRARY
New York, U. S. A.
- NICHOLSON, REGINALD
London, England
- NORDISKA BOKHANDELN, A.-B.
Stockholm, Sweden
- NORDSTRÖM, ANDREAS
Stockholm, Sweden
- OBERLIN COLLEGE LIBRARY
Oberlin, U. S. A.
- OEFFENTLICHE BIBLIOTHEK DER
UNIVERSITÄT
Basel, Switzerland
- PALESTINE INSTITUTE OF THE PACIFIC
SCHOOL OF RELIGION
Berkeley, U. S. A.
- PETTERSON, ALFRED V.
Stockholm, Sweden
- PHILIPPOU, LOIZOS
Paphos, Cyprus
- PIERIDES, ZENO D.
Larnaca, Cyprus
- DU PLAT TAYLOR, JOAN
Nicosia, Cyprus
- POULIA, GEORGE
Nicosia, Cyprus
- PREUSSISCHE STAATSBIBLIOTHEK
Berlin, Germany
- PUBLIC LIBRARY
Newcastle upon Tyne, England
- QUEEN'S UNIVERSITY LIBRARY
Kingston, Canada
- RYDH, HANNA
Östersund, Sweden
- SACHS, JOSEF
Stockholm, Sweden
- SANTIS, N. G.
Famagusta, Cyprus
- SAXON, J. L.
Stockholm, Sweden
- SCHALLING, ERIK
Saltsjobaden, Sweden

VON SNEIDERN, AXEL
Vänersborg, Sweden

TURITZ, H. G.
Göteborg, Sweden

SCUOLA BRITANNICA
Roma, Italy

TWIETMEYER, A.
Leipzig, Germany

SÉMINAIRE DE PHILOLOGIE CLASSIQUE
DE L' UNIVERSITÉ
Neuchâtel, Switzerland

UNIVERSITÄTS-BIBLIOTHEK
Marburg, Germany

SEMINARIET FÖR KLASSISK FORNKUNSKAP
OCH ANTIKENS HISTORIA
Uppsala, Sweden

UNIVERSITETSBIBLIOTEKET
Oslo, Norway

UNIVERSITY OF CALIFORNIA LIBRARY
Berkeley, U. S. A.

SERVICES DES ANTIQUITÉS
Beyrouth, Syria

UNIVERSITY OF CINCINNATI LIBRARY
Cincinnati, U. S. A.

SEYRIG, HENRI
Beyrouth, Syria

UNIVERSITY OF LIVERPOOL LIBRARY
Liverpool, England

SIMON, FALK
Göteborg, Sweden

UNIVERSITY OF MINNESOTA
Minneapolis, U. S. A.

SOTHERAN, HENRY, LTD.
London, England

UNIVERSITY OF PENNSYLVANIA
Philadelphia, U. S. A.

STAATLICHE MUSEEN
Berlin, Germany

WALLENBERG, BERIT
Stockholm, Sweden

STAVENOW, LUDVIG
Uppsala, Sweden

WALLENBERG, K. A.
Stockholm, Sweden

STOCKHOLMS STADSBIBLIOTEK
Stockholm, Sweden

WENNER-GREN, AXEL L.
Stockholm, Sweden

STUBBS, EDWARD
Nicosia, Cyprus

WERNER, GUSTAF
Göteborg, Sweden

TALCOTT, LUCY
Athens, Greece

WESTERBERG, STEN
Stockholm, Sweden

TEA, EVA E MARIA
Milano, Italy

WESTERDAHL, NILS
Stockholm, Sweden

TRAUGOTT, IVAN
Stockholm, Sweden

WETTER, ERIK
Göteborg, Sweden

TRINITY COLLEGE
Dublin, Ireland

WEYHE, E.
New York, U. S. A.

WIJKANDER, THEODOR
Göteborg, Sweden

P R E F A C E

Having on two occasions visited Cyprus, and carried out preliminary soundings and excavations on a small scale, Dr. E. Gjerstad, Ph. D., Lecturer in Classical Archaeology and Ancient History at the University of Uppsala, suggested in the year 1927 that more extensive archaeological research work should be started in Cyprus. At his instigation the Swedish Cyprus Committee was formed, consisting of the undersigned, for the purpose of acting as a support to Dr. Gjerstad's work in the field. The Swedish Cyprus Expedition, which has been the name of this undertaking, consisted of Dr. E. Gjerstad, who was appointed chief of the Expedition, with J. Lindros, Architect, E. Sjöqvist, Ph. Lic., and A. Westholm, Ph. Lic., as assistants. Dr. Gjerstad has organized and directed the whole of the excavations. Mr. Lindros has acted as draughtsman and photographer, Messrs. Sjöqvist and Westholm have been in charge of the archaeological work and also made photographic and drawing work; Mr. Sjöqvist at Ajia Irini, Lapithos, Ajios Jakovos, Paleoskou-tella, Nitovikla, Trachonas, Kountoura Trachonia, Enkomj, Stylli, Idalion, Marion and Mr. Westholm at Petra tou Limniti, Vouni, Mersinaki, Soli, Kythrea, Kition, Amathus.

Permission for the work having been most readily granted by the authorities of Cyprus, the excavations started at the end of September 1927 and were in progress until February 1931. The Expedition left Cyprus in March 1931. After its return to Sweden the publication of the results of the excavations has been prepared. Of this publication the first volume is herewith issued.

The publication has been entrusted to Dr. Gjerstad. The text is written by Dr. Gjerstad, Messrs. Sjöqvist, and Westholm. The parts signed E. G. are written by Gjerstad, those signed E. S. by Sjöqvist, and those signed A. W. by Westholm.

The work of the Expedition in Cyprus was much assisted by the great interest taken in it by Sir Ronald Storrs, at that time Governor of Cyprus, Mr. Rupert Gunnis, Inspector of Antiquities, Mr. M. Markides, at that time Curator of Cyprus Museum, and the Members of the Cyprus Museum Committee. A conspicuous token of this interest was given at the division of the finds between the Cyprus Museum and the excavators: thanks to the generosity of Sir Ronald Storrs and the Museum Authorities a considerable number of finds was allotted to the Expedition. The Committee expresses its great gratitude for the benevolence shown to the Expedition. The regretted death of Mr. L. Z. Pierides, late Swedish Consul in Larnaca, prevents the Committee from thanking him for much valuable assistance in the work of the Expedition. *Requiescat in pace!*

The Committee has to acknowledge financial support from the Swedish State: a sum of 35,000 Swedish crowns was granted as a contribution towards excavation expenses and another sum of 50,000 Swedish crowns was given to cover the expenses for the scientific preparing of the material for publication.

The Committee has also received considerable material support from private persons interested in archaeological research. Omitting donors who have expressed a wish to remain anonymous these persons are: Messrs. B. Almgren, Erik Åqvist, Ernst Åqvist, T. Åqvist, C. Fr. Bennet, C. Alb. Collett, S. Dehlgren, C. Frisk, K. Heinecke, Fr. Heiss, E. Hultmark, Fr. Jansson (†), A. Ax:son Johnson, Harry Ax:son Johnson, A. Kleist, L. E. Larsson, Aug. Nachmanson, N. Rettig (†), J. Sachs, H. Unell (†), O. Wallenberg.

The Committee thanks everyone of these gentlemen, named or unnamed, for their generous assistance without which it would have been impossible to carry out such an elaborate excavation program with results, which we venture to hope may be of value to the study of archaeology in Cyprus and neighbouring countries.

Stockholm, June 1934.

GUSTAF ADOLF

JOH. HELLNER

S. CURMAN

MARTIN P. NILSSON

AXEL W. PERSSON

I N T R O D U C T I O N

From its geographical position the Island of Cyprus was naturally destined to play an important role in the history of ancient civilization. It served as a connecting link between the Orient and the Occident, its culture was exposed to various waves of influence from the highly developed neighbouring civilizations of Anatolia, Syria, Egypt, Ionia, and Greece, and the interrelations of many of the essential features of these cultures can therefore be well studied in Cyprus. The importance of Cypriote civilization is not, however, restricted to its role of intermediary of culture. Cyprus was also a creator of culture and possessed an indigenous civilization which at different times reached a high standard. True, Cypriote culture has not the monumentality of Egyptian and Mesopotamian civilizations and Cyprus did not possess the neo-creative power of Greece but its products are equal to and in several respects surpass in quality those of the other cultures that flourished around the Mediterranean before the Roman Empire.

This may sound strange and exaggerated to some readers; Cypriote culture has not a good reputation in the opinion of several scholars. — The reason for this seems to be, that though earlier researches — above all those of Professor Myres — have proved that Cyprus has played a considerable part in the history of civilization, exact knowledge of Cypriote culture is rather scanty, from the fact that comparatively little of the available archaeological material comes from scientific excavations. Scholars have complained of this state of things again and again and all have agreed that steps ought to be taken to find a remedy as soon as possible.

In recognition of these legitimate complaints the Swedish Cyprus Expedition has endeavoured to explore the Cypriote culture on a large scale employing the scientific methods of modern field archaeology, with the object in view of publishing a comprehensive work dealing with the history and culture of Cyprus from the Stone Age down to the end of the Roman era. For this purpose it was necessary to excavate a sufficient number of settlements, temple-sites, and tombs in order to obtain a representative and chronologically unbroken series of monuments and finds from the earliest to the latest of the periods concerned. Furthermore, these excavations had to be carried out at different localities in order to eliminate false conclusions from cultural differences caused by topographical conditions. The expedition was therefore organized as a movable, ambulatory expedition. The whole of Cyprus became its field of work.

To an expedition of this kind Cyprus is a very suitable field of action. Being an island, not only its geographical but also its cultural boundaries are fixed, and it is not so large as to render it impossible to obtain a general view of its history and culture within reasonable time.

The excavations were in progress for about 3 1/2 years, from September 1927 to March 1931. Stone Age settlements were excavated on Petra tou Limniti, at Lapithos, and Kythrea; a fortress from the Middle and Late Bronze Ages at Nitovikla; a palace from the Cypro-Classical period at Vouni; temple-sites dating from the Late Bronze Age to the end of the Roman period at Ajios Jakovos, Kition, Idalion, Ajia Irini, Soli, Mersinaki, and Vouni; a theatre from the Hellenistic and Roman periods in Soli; tombs from the Early Bronze Age to the beginning of the Hellenistic period at Lapithos, Ajios Jakovos, Paleoskoutella, Kountoura Trachonia, Trachonas, Enkomi, Stylli, Idalion, Amathus, Marion, and Vouni. In addition, the Expedition has obtained the right to publish the results of the excavation of the temple-site at Arsos carried out by Mr. M. Markides in 1914, at that time Keeper of the Cyprus Museum.

When a site was chosen for excavation a contoured field-plan of the locality was drawn on which the excavated remains were marked. The area to be excavated, if a settlement or a temple-site, was divided into squares of usually 1, 1.5, or 2 m. sq. The stratification of each square was observed, and as far as possible, the earth was removed stratum by stratum in accordance with the natural stratification or, where this was not possible, in arbitrary layers, 0.10 or 0.20 m. deep. The relation of the walls to the strata was constantly noticed, the location of every find was marked on the find-plan, its level and stratum were noted. For potsherds and other unnumbered fragments, of course, only their respective layers were recorded. Sections of every important part of the stratification were drawn, for every square, every second square etc. in accordance with the demands of the stratigraphical conditions of respective places. The daily observations and descriptions were recorded in diaries, the finds were preliminarily registered, and the camera was in frequent use to control the correctness of the drawings and the descriptions and to supplement the conclusive evidence of these. At the end of the excavation the architectural remains, their construction and material, form and plan were recorded in a definite and comprehensive description.

The excavations of the tombs were carried out, in those parts applicable, with the same methods.

When the excavations were finished the finds were transported to the central deposit in Nicosia. There the usual registration work was done, the finds were cleaned, restored, classified, and described. Thus the principle was followed that the working at the material as much as possible should keep step with the excavations, in recognition of the fact that in this way it was possible to organize the excavations better both in scientific and economic respects. Furthermore, it is evident that this is useful also for the working at the material obtained. For however careful and instructive the records are, however good and numerous drawings and photos are obtained, they can always be usefully supplemented from the

memory of the excavator himself, having made his observations during the excavation. Moreover, in this way it is easy to re-examine the remains on the actual site, again and again, if necessary.

The publication of the results obtained by the excavations will comprise four volumes of text with illustrations, topographical and architectural plans, and three volumes of plates.

The account of the excavations will form the contents of three of the text volumes while the typology and chronology of the finds together with historical deductions will be given in the fourth. In this way we have followed the principle of separating the statements of the archaeological data produced by the excavations from the deductions based upon them, the objective descriptions from the conclusions. This disposition has been chosen in order to give the work a logical structure, and to facilitate a judgement of what are matters of facts and interpretations of these. It is evident, however, that this separation of the descriptions from the conclusions cannot be realized in every respect. Some facts would mean nothing without an interpretation, others require an interpretation to be clearly understood. Furthermore, the finds of each excavation must, of course, already be classified and assigned to their respective periods in the excavation reports.

The reasons for the classification and the chronology, however, must be reserved for the last volume, as they depend on a study of the whole material. It is thus evident that some of the results obtained from the typological and chronological studies published in the last volume must be taken as known in the descriptive part of the publication, or, in other words, the excavation reports are published in the form they would have if the typological and chronological evidence based upon the results of the excavations already existed.

As a guidance to the reader and in order to enable him to use the descriptive part of the publication before its historical part has appeared it is well to bear in mind that the classification of the pottery (apart from some minor additions) is that given in "Cypriote Pottery" (*Union Académique Internationale*, Classification des céramiques, 16) and the chronological scheme worked out on the basis of the results of the excavations comprises the following periods:

I. STONE AGE	II. BRONZE AGE	III. IRON AGE
Pre-Neolithic	Early Cypriote I—III	Cypro-Geometric I—III
Neolithic.	Middle Cypriote I—III	Cypro-Archaic I—II
	Late Cypriote I—III.	Cypro-Classic I—II
		Cypro-Hellenistic I—II
		Cypro-Roman I—III.

So much for the general arrangement of the work. The disposition of the special parts of the work follows a systematic order. The publication of the architectural excavations begins with a description of the architectural elements, their material and construction, then the stratification is described and in accordance with that the different periods of inhabitation are fixed; thereafter an architectural analysis is worked out on the basis of the construction of the architectural elements, their relation to each other and to the strata of

the successive periods; when the architectural elements thus are assigned to their respective periods a synthesis of the architecture of each period is given; the elements are unified into the architectural structures formed by them; the form and style of the buildings are characterised. From the architecture the description proceeds to the finds. Every find is described in an Object Register. At the end of each description the size of the object is given in centimeters, its weight, when stated, in grams, and by indicating the square and the level where it was found, both its horizontal and vertical position are fixed. The levels are given in decimeters and centimeters from an arbitrary datum called 100. After a classification of the finds thus described they are assigned to their respective periods of occupation according to the level, stratum, and other conditions of finds. When thus the relative chronology of the finds has been established their absolute chronology is given and, finally, the results of the excavation are summed up in concluding remarks. This general scheme is subject to some variations in accordance with the special demands of each excavation.

The publication of the tombs follows, in general, the same scheme: the shape of the tomb is described first, then the stratification, the burial customs, and the finds. At the end of each description the measures and levels of the finds are given. Finally the finds are dated. The levels are given in centimeters below or above an arbitrary datum (e. g. — 10 or + 10 mean 10 centimeters below or 10 centimeters above the datum). In the Lapithos tombs the line of the plan section is used as a datum, in all other tombs a special datum line, marked on the plans, is used.

It is to be observed that the measurements of walls and tombs given at the head of each description always refer to their maximum measurements in order to give the reader a general idea of their size. For measurements in detail the reader is referred to the plan.

In terminological respects the common archaeological terms are used. Only in three cases native words have been used and their sense may therefore be explained. Thus *chavara* the Cypriotes call a calcareous tufa containing small pebbles, which is employed as gravel. *Chonnos* is a kind of gritty sandstone sometimes hard but usually very soft and shaly. It occurs principally in the northern part of the island, where it is used for covering roofs of houses. *Chonnos* is also known as *Macignos* according to the Italian terminology and as *Hummocks*. *Hali* land is called uncultivated common land.

As to the illustrations the following principles have been followed. Photos of scenery, architectural monuments and details, stratigraphic matters, finds *in situ* etc. are reproduced as autotypes in the text. As phototypic text illustrations are reproduced drawings of the excavated tombs: plans and sections of the tombs and plans of their finds *in situ*. The plans and sections of the tombs are usually reproduced in a rather small scale but large enough to allow a safe judgement of the shape of the tomb and stratification. A larger scale would only have raised the price of the publication without any essential improvement. The find plans, on the other hand, are given in a larger scale so that every object can be identified as found in the tombs. Drawings of architectural plans, sections, and façades are reproduced in folding plans. Pictures of the finds are reproduced in heliotypes in separate volumes of plates. These plates are of two kinds: groups and types. The groups illustrate

the entire contents of the tombs or deposits, the types show a representative series of all the characteristic shapes and ornaments. If some objects are not illustrated in the groups they are, as a rule, in such a bad state of preservation that their illustration would be useless. It may be said that the groups are reproduced on such a small scale that they sometimes do not allow a study of details of ornaments etc. A reproduction of the groups in a double scale to that used would, however, have raised the price of the publication about 33 %. It was therefore deemed practical to reproduce the groups on a smaller scale but to supplement them with type illustrations of all the characteristic shapes and ornaments. Thus, the groups are intended to satisfy the archaeological demand to have the complete contents of every closed find group illustrated in collective and surveyable pictures, large enough to allow the reader to form an idea of every object of every find group and to identify them by aid of the descriptions in the Object Register. For studies of details in shapes and ornaments the reader is referred to the types. These are so numerous that all the shapes and ornaments typical of every class of objects are represented among the illustrations. The group plates are placed in topographical order and sequence of tombs following the arrangement of the text. The only discrepancy from the text arrangement is that, in order to obtain continuous illustration of the Stone Age finds those from Kythrea are illustrated next to those from the Neolithic settlement at Lapithos.

The disposition of the type plates is naturally given by the typological sequence of the classes of objects illustrated.

The plates are registered on two lists of plates: List of Plates I (in the text abbr. L. of Pl. I) and List of Plates II (in the text abbr. L. of Pl. II). List of Plates I gives a register of the plates in numerical order. In List of Plates II, all the illustrations of finds from each tomb are registered under the headings of the respective tombs, so that the reader can easily obtain a survey of all the illustrative material referring to every tomb.

The non-ceramic objects on the group plates, and all the objects on the type plates are marked with their numbers in the Object Registers, and on the type plates a letter in front of the numbers indicates the excavation site: A. = Amathus, A. I. = Ajia Irini, A. J. = Ajios Jakovos, E. = Enkomi, I. = Idalion, K. = Kition, K. T. = Kountoura Trachonia, Ky. = Kythrea, L. = Lapithos, M. = Marion, Me. = Mersinaki, N. = Nitovikla, P. = Paleoskoutella, PTL. = Petra tou Limniti, S. = Stylli, T. = Trachonas, V. = Vouni. Thus, L. 401.45 means Lapithos, Tomb 401, Object No. 45 etc.

On the group plates, the numbers of the pottery vases are not indicated, but the reader is referred to List of Plates I, where the numbers of the vases are arranged in lines corresponding to the rows of pots on the plates.

No scales of the objects are given on the plates, as that would injure the artistic impression. For measurements, the reader is referred to the Object Registers.

Apart from the abbreviations mentioned above, there are none used which are not common in archaeological literature, or are not such as may be immediately understood.

The whole work is dedicated to the Ladies of the Expedition in grateful recognition of much valuable assistance and collaboration.

If the language does not betray the foreign writers too much this is the merit of Miss Joan du Plat Taylor, Assistant Keeper of the Cyprus Museum, and Miss Kathleen M. Kenyon. Miss Taylor has revised the MSS. and Miss Kenyon the proofs. My deep gratitude for the unselfish and trying work of these ladies is not less than my admiration for their ability to render our sometimes clumsy expressions at least, I hope, intelligible.

Mrs. Vivi Gjerstad has rendered good service to the Expedition in various ways both during the excavations in Cyprus and during the preparation of the publication by reading proofs etc. Miss Margareta Sjöqvist has been in charge of the registration work, assisted in typing MSS. has done all the office work and in general acted as a monitor holding a protective hand over the papers, photos, and plans of the Expedition. Mrs. Svea Adling has typed a good deal of the MSS. and shown a great ability in interpreting the crabbed writing of some MSS. and finding her ways through their labyrinths. Mrs. Karin Hermann has shown great skill in mending and reconstructing vases. Mrs. Rosa Lindros has bestowed much labour in making clean drawings of a great number of plans, Miss Nordenfeldt, Miss Elsa Sandberg and Miss V. Lindegren have assisted in the same work. Mrs. Inez Sjöqvist has assisted in reading proofs, Miss Bessie de Champs in controlling measurements etc., Miss Lisa Rügheimer in reading proofs, preparing the Table of Contents, Lists of Illustrations etc.

The Expedition, however, has not only taken advantage of the much appreciated work of these ladies but has also derived benefit from the learning and technical skill of male collaborators. Professor Percy Newberry and Dr. Max Pieper have deciphered and described the scarabs found at the excavations, and Professor Newberry has also made drawings of a great number of scarabs. The results of the esteemed work of these gentlemen will not appear before the second volume as no descriptions of scarabs are published in the first volume. Dr. Riedel has read the cuneiform inscription of a cylinder seal and Mr. Willimott, the Government's Analyst in Cyprus, has analyzed some metal objects.

Professor Carl M. Fürst of the University of Lund has been so very kind as to examine the anthropological material of the Expedition and the results of this examination have already been published (Carl M. Fürst, *Zur Kenntnis der Anthropologie der prähistorischen Bevölkerung der Insel Cypern*, Lund 1933).

Dr. E. Kjellberg has assisted in describing sculptures from Vouni during his visit to Cyprus in the summer of 1929.

Professor Wallengren of the University of Lund and Professor Palmgren in Stockholm have examined the animal bones found during the excavations. Professor H. Backlund of the University of Uppsala has analysed some clay and plaster samples and Dr. Nils Zensén has analysed and determined some pre-Neolithic and Neolithic stone implements. Mr. H. Faith-Ell has done some of the photographic work.

Both during the excavations in Cyprus and during the work in Sweden the Expedition has been fortunate enough to have Mr. Tooulis Svidos, Nicosia, in its service. He has been the Expedition's Jack-of-all-trades, excellent in most branches of practical work, and has proved to be a most skilful mender of pottery and sculptures. Mr. H. Gelin,

Uppsala and Mr. G. Olson, Statens Historiska Museum, Stockholm, have done conservation work on metal objects and successfully saved many, apparently hopeless cases. The Expedition has also to acknowledge the elaborate and intelligent work of Mr. Bror Millberg, Stockholm, in controlling and making fair copies of a great number of plans. Messrs. Björnson-Langen and N. Carlsten have also assisted in making fair copies of plans and Mr. F. A. Stenqvist has done a careful work in cleaning antiquities.

At the excavations in Cyprus the Expedition used as foremen Messrs. Jorkos Anastasiou, Lazaros Nikolaou, Loizos and the late Michalis Nikolaou, attendants at the Cyprus Museum; Messrs. Christos Grigoriou, Jorkis Andrea, and Simeon Stavrou were trained workmen; Kakoullis Georgiou and Chrysostomos Paraskeva were engaged as attendants of our collections in Cyprus. Last but not least I want to lay stress upon the contribution of our Cypriote labourers to the result of the excavations. Many of them, whom I can not enumerate on account of their great number, have not only made their regular work but have, at various occasions, promoted the cause of the Expedition.

To everybody I express the warm gratitude of the Expedition.

The heliotypes are produced by Mr. John Kroon, Malmö Ljustrycksanstalt; the autotypes, phototypes, and plates in colour by Dagens Nyheter's Klichéanstalt, Stockholm, under the supervision of Mr. G. Wickman; the folding plans by Statens Reproduktionsanstalt, Stockholm.

Finally I have gratefully to acknowledge the receipt of 5,000 Swedish crowns from "Fonden för tryckning av lärda verk", and 3,000 Swedish crowns from "Humanistiska Fonden" as contribution to the printing expenses of this volume of the publication.

EINAR GJERSTAD

C O N T E N T S

	Page
DEDICATION	V
SUBSCRIBERS	VII
PREFACE	XII
INTRODUCTION	XIV
CONTENTS	XXI
LIST OF ILLUSTRATIONS IN THE TEXT	XXIV
LIST OF PLANS	XXVIII
LIST OF PLATES I	XXIX
LIST OF PLATES II	XLVIII

PETRA TOU LIMNITI

I

Topography, p. 1; Architecture, p. 2; Finds, p. 7; Classification of finds, p. 9; Relative Chronology, p. 11; Absolute Chronology, p. 12.

LAPITHOS

13

NEOLITHIC SETTLEMENT, p. 13. Topography, p. 13. *The Eastern Settlement*, p. 14; Architecture, p. 14; Stratification, p. 16; Architectural Analysis and Synthesis, p. 18. *The Western Settlement*, p. 19; Architecture, p. 19; Stratification, p. 21; Architectural Analysis, p. 23; Architectural Synthesis, p. 24; Finds, p. 26; Classification of Finds, p. 27; Relative Chronology, p. 30; Absolute Chronology, p. 33.

THE NECROPOLIS AT VRYSI TOU BARBA, p. 33. Tomb 301, p. 34; Tomb 302, p. 38; Tomb 303, p. 47; Tomb 304, p. 51; Tomb 305, p. 53; Tomb 306, p. 57; Tomb 307, p. 62; Tomb 308, p. 66; Tomb 309, p. 70; Tomb 310, p. 76; Tomb 311, p. 76; Tomb 312, p. 83; Tomb 313, p. 85; Tomb 314, p. 99; Tomb 315, p. 105; Tomb 316, p. 115; Tomb 317, p. 122; Tomb 318, p. 124; Tomb 319, p. 128; Tomb 320, p. 133; Tomb 321, p. 139; Tomb 322, p. 140; Tomb 323, p. 157; Summary, p. 160.

THE NECROPOLIS AT KYLISTRA AND AJIA ANASTASIA, p. 162. Tomb 501, p. 163; Tomb 502, p. 164; Tomb 701, p. 164; Tomb 702, p. 164

THE NECROPOLIS AT KASTROS, p. 172. Tomb 401, p. 173; Tomb 402, p. 179; Tomb 403, p. 184; Tombs 404—405, p. 192; Tomb 406, p. 194; Tomb 407, p. 201; Tomb 408, p. 204; Tomb 409, p. 209; Tomb 410, p. 210; Tomb 411, p. 213; Tomb 412, p. 216; Tomb 413, p. 219; Tomb 414, p. 222; Tomb 415, p. 223; Tomb 416, p. 225; Tomb 417, p. 226; Tomb 418, p. 232; Tomb 419, p. 233; Tomb 420, p. 234; Tomb 421, p. 240; Tomb 422, p. 241; Tomb 423, p. 246; Tomb 424, p. 248; Tomb 425, p. 249; Tomb 426, p. 252; Tomb 427, p. 254; Tomb 428, p. 256; Tomb 429, p. 262; Summary p. 264.

THE NECROPOLIS AT PLAKES, p. 265. Tomb 601, p. 266; Tomb 602, p. 269; Tomb 603, p. 274; Summary p. 276.

KYTHREA 277

Topography, p. 277; Architecture, p. 278; Stratification, p. 282; Classification of Huts, p. 285; Finds, p. 286; Classification of finds p. 295; Relative Chronology, p. 298; Absolute Chronology, p. 298; Diagram, pp. 300—301.

AJIOS JAKOVOS 302

THE NECROPOLIS OF MELIA, p. 302. Tomb 1, p. 302; Tomb 2, p. 306; Tomb 3, p. 308; Tomb 4, p. 309; Tomb 5, p. 313; Tomb 6, p. 314; Tomb 7, p. 322; Tomb 8, p. 325; Tomb 9, p. 335; Tomb 10, p. 337; Tomb 11, p. 340; Tomb 12, p. 341; Tomb 13, p. 345; Tomb 14, p. 349; Summary p. 354.

THE CULT PLACES AT DHIMA, p. 355. The Bronze Age Sanctuary, p. 356; The Iron Age Sanctuary, p. 361.

NITOVIKLA 371

THE FORTRESS, p. 371. Architecture, p. 374; Stratification, p. 383; Architectural Analysis and Relative Chronology, p. 388; Architectural Synthesis, p. 394; Absolute Chronology, p. 403.

THE NECROPOLIS, p. 407. Tomb 1, p. 407; Tomb 2, p. 410.

PALEOSKOUTELLA 416

Tumulus 1, p. 416; Tumulus 2, p. 421; Tumulus 3, p. 423; Tumulus 4, p. 423; Tumulus 5, p. 426; Tumulus 6, p. 428; Tumulus 7, p. 429; Concluding remarks, p. 437.

KOUNTOURA TRACHONIA	439
Tomb 1, p. 439; Tomb 2, p. 440; Tomb 3, p. 442; Tomb 4, p. 445; Tomb 5, p. 445; Tomb 6, p. 446; Tomb 7, p. 447; Tomb 8, p. 449; Tomb 9, p. 450; Tomb 10, p. 452; Tomb 11, p. 454; Tomb 12, p. 455; Tomb 13, p. 456; Tomb 14, p. 458; Tomb 15, p. 459; Chronology p. 459.	
TRACHONAS	461
The built tomb, p. 461.	
ENKOMI	467
Tomb 1, p. 468; Tomb 2, p. 470; Tomb 3, p. 475; Tomb 4, p. 486; Tomb 5, p. 490; Tomb 6, p. 491; Tomb 7, p. 498; Tomb 8, p. 500; Tomb 9 p. 504; Tomb 10, p. 505; Tomb 11, p. 510; Tomb 12, p. 525; Tomb 13, p. 526; Tomb 14, p. 536; Tomb 15, p. 537; Tomb 16, p. 540; Tomb 17, p. 541; Tomb 18, p. 546; Tomb 19, p. 558; Tomb 20, p. 568; Tomb 21, p. 570; Tomb 22, p. 573; Summary, p. 575.	
APPENDIX	576
NOTES	578

LIST OF ILLUSTRATIONS IN THE TEXT

Fig.		Page	Fig.		Page
1	Petra tou Limniti from the South-East	1	29	Lapithos. Tomb 303 A. Interior view with finds <i>in situ</i>	51
2	Petra tou Limniti from the North-East	1	30	Lapithos. Tomb 311, dromos	51
3	Petra tou Limniti. The excavated huts	2	31	Lapithos. Tomb 305, Plan (1); Sections A-A, B-B (2, 3). Tomb 306, Plan (4); Sections A-A, C-C, B-B (5, 6, 7); Chamber C, Finds <i>in situ</i> (8); Necklace No. 24 in Tomb 306 A <i>in situ</i> (9)	54
4	Petra tou Limniti. The top plateau before excavation	3	32	Lapithos. Tomb 306, Chamber A with finds <i>in situ</i> (1). Tomb 307, Plan (3); Sections A-A, B-B (2, 4); Chamber A with finds <i>in situ</i> (5)	59
5	Petra tou Limniti. The earth floor of Petra III	3	33	Lapithos. Tomb 307 B, Finds <i>in situ</i> (1). Tomb 308, Plan (2); Section A-A (3); Finds <i>in situ</i> (4)	67
6	Petra tou Limniti. The cave	4	34	Lapithos. Tomb 309, Plan (1); Sections B-B, A-A (2, 3); Chamber A with finds <i>in situ</i> (4)	71
7	Petra tou Limniti. The hearth	4	35	Lapithos. Tomb 309 A. Skeleton <i>in situ</i>	72
8	Petra tou Limniti. Hole for fixing wooden door post	5	36	Lapithos. Tomb 311 A. Interior view with finds <i>in situ</i>	72
9	Petra tou Limniti. Hole for fixing wooden door post	5	37	Lapithos. Tomb 309 B, Finds <i>in situ</i> (1). Tomb 310, Plan (2); Section A-A (3). Tomb 311, Plan (4); Sections A-A, B-B (5, 6). Tomb 312, Plan (7); Sections B-B, A-A (8, 9)	77
10	Lapithos. Alonia ton Plakon with the Kerynia range in the background	14	38	Lapithos. Tomb 311 A-B, Finds <i>in situ</i> (1, 2). Tomb 313, Sections C-C, B-B, E-E, D-D, A-A (3, 4, 5, 6, 7); Necklaces Nos. 78 and 32+42+44 in Tomb 313 B <i>in situ</i> (8, 9)	82
11	Lapithos. Alonia ton Plakon with the sea in the background	15	39	Lapithos. Tomb 312 A. Interior view with finds <i>in situ</i>	84
12	Lapithos. The eastern settlement	17	40	Lapithos. Tomb 313, dromos	84
13	Lapithos. The hearth in the eastern settlement	19	41	Lapithos. Tomb 313 A. Interior view	86
14	Lapithos. Bothros I of the eastern settlement	19	42	Lapithos. Tomb 313 A. Interior view	86
15	Lapithos. The hut of the western settlement	20	43	Lapithos. Tomb 313, Plan (1); Chamber B, Finds <i>in situ</i> (2)	88
16	Lapithos. The western settlement. Filled holes for wooden posts in the longitudinal axis of the hut	21	44	Lapithos. Tomb 314, Plan (1); Sections B-B, A-A (2, 3); Finds <i>in situ</i> (4, 5)	101
17	Lapithos. The western settlement. Filled hole for wooden post (Square A 4).	21	45	Lapithos. Tomb 315, Plan (1); Chamber A with finds <i>in situ</i> (2)	107
18	Lapithos. The western settlement. Walls 3 and 4	24	46	Lapithos. Tomb 315, Sections A-A, B-B (1, 2). Tomb 316, Plan (3); Sections A-A, B-B (4, 5); Finds <i>in situ</i> (6)	114
19	Lapithos. The western settlement. Analytical plan of the huts	24	47	Lapithos. Tomb 316, dromos	116
20	Lapithos. View from the mountains towards the sea	34	48	Lapithos. Tomb 318, dromos	116
21	Vrysi tou Barba. The necropolis during excavation	35	49	Lapithos. Tomb 317, Plan (1); Sections A-A, B-B, C-C (2, 3, 4). Tomb 318, Plan (5). Tomb 319, Plan (6)	125
22	Lapithos. Tomb 301, dromos	36			
23	Lapithos. Tomb 302, dromos	36			
24	Lapithos. Tomb 301, Plan (1); Sections A-A, B-B (2, 3). Tomb 302, Plan (4); Sections A-A, B-B, C-C (5, 6, 7)	39			
25	Lapithos. Tomb 302 A. Traces of the cutter's tool	40			
26	Lapithos. Tomb 303, dromos	40			
27	Lapithos. Tomb 302 A (1); Tomb 302 B (2); Tomb 302 C (3), Finds <i>in situ</i>	41			
28	Lapithos. Tomb 303, Plans (1, 3); Sections B-B, C-C, A-A (2, 4, 5); Finds <i>in situ</i> (6, 7). Tomb 304, Plan (8); Sections A-A, B-B (9, 10)	48			

50	Lapithos. Tomb 318, Section A-A (1). Tomb 319, Sections B-B, A-A (4, 5). Tomb 320, Plan (2); Section A-A (3); Finds <i>in situ</i> (6)	129	78	Lapithos. Tomb 413, dromos	219
51	Lapithos. Tomb 320. Finds <i>in situ</i>	133	79	Lapithos. Tomb 413. Interior view of chamber with finds being removed	219
52	Lapithos. Tomb 322 A. Hoard of bronzes <i>in situ</i>	133	80	Lapithos. Tomb 415, Plan (1); Sections A-A, B-B (2, 3). Tomb 416, Plan (4); Section A-A (5). Tomb 417, Plan (6); Sections B-B, A-A (7—9); Finds <i>in situ</i> (8)	225
53	Lapithos. Tomb 321, Plan (1); Sections A-A, B-B, C-C (2, 3, 4). Tomb 322, Plan (5); Sections A-A, B-B (6, 7)	141	81	Lapithos. Tomb 417, dromos	226
54	Lapithos. Tomb 322 A. Interior view with Niches 3, 4, 5, and 6	143	82	Lapithos. Tomb 420, dromos	226
55	Lapithos. Tomb 322 B. The necklace (No. 14) <i>in situ</i>	143	83	Lapithos. Tomb 417. Door-packing.	227
56	Lapithos. Tomb 322, Sections C-C, D-D, E-E, F-F (1, 2, 3); Chamber A, Finds <i>in situ</i> (4)	144	84	Lapithos. Tomb 417. North corner of chamber with finds <i>in situ</i>	227
57	Lapithos. Tomb 322, Chambers B and D, Finds <i>in situ</i> (1, 2).	145	85	Lapithos. Tomb 417. South corner of chamber with finds <i>in situ</i>	228
58	Lapithos. Tomb 322 E, Finds <i>in situ</i> (1). Tomb 323, Sections A-A, B-B, C-C (2)	146	86	Lapithos. Tomb 417. Skeleton I	228
59	Lapithos. Tomb 322, dromos	157	87	Lapithos. Tomb 418, Plan (1); Sections B-B, A-A (2, 3). Tomb 419, Plan (4); Sections C-C, A-A, B-B (5—7). Tomb 420, Plan (8); Sections B-B, A-A, C-C (9—11); Finds <i>in situ</i> (12)	235
60	Lapithos. Tomb 323	157	88	Lapithos. Tomb 422, dromos. Remains of human sacrifices covered by stone slabs	242
61	Lapithos. Tomb 323, Plan (1). Tomb 501, Plan (2); Sections A-A, B-B (3, 4)	161	89	Lapithos. Tomb 422, dromos. Skeletons after removal of stone slabs	242
62	Lapithos. Tomb 501	163	90	Lapithos. Tomb 422, dromos with sacrificial table <i>in situ</i>	243
63	Lapithos. Tomb 702, Finds <i>in situ</i>	163	91	Lapithos. The dromoi of Tombs 426, 422, 425 (from the left to the right).	243
64	Lapithos. Kylistra	165	92	Lapithos. Tomb 422. The sacrificial table	244
65	Lapithos. The necropolis at Kastros with Anastasia in the background	173	93	Lapithos. Tomb 422. Stomion with sculptured door-jamb	244
66	Lapithos. Tomb 401, dromos	179	94	Lapithos. Tomb 421, Plan (1); Section A-A (2). Tomb 422, Plan (3); Skeletons in dromos (4); Section A-A (5); Finds <i>in situ</i> (6). Tomb 423, Plan (7); Sections B-B, A-A (8, 9). Tomb 424, Plan (10); Sections A-A, B-B (11, 12)	247
67	Lapithos. Tomb 401. Interior view of a part of finds <i>in situ</i>	179	95	Lapithos. Tomb 425, Plan (1); Sections A-A, B-B (2, 3); Finds <i>in situ</i> (4). Section through chamber of Tombs 425, 422, 426 (5). Tomb 426, Plan (6); Sections B-B, C-C, A-A (7—9). Tomb 427, Plan (10, 11); Sections B-B, A-A (12, 13)	253
68	Lapithos. Tomb 401, Plan (1); Sections C-C, A-A, B-B (2—4). Tomb 402, Plan (5); Sections A-A, B-B (6, 7). Tomb 403, Plan (8); Sections B-B, A-A, (9, 10)	180	96	Lapithos. Tomb 427, dromos	255
69	Lapithos. Tomb 401, Finds <i>in situ</i> (1). Tomb 402, Finds <i>in situ</i> (2). Tomb 403, Finds <i>in situ</i> (3)	181	97	Lapithos. Tomb 429, dromos	255
70	Lapithos. Tomb 403, dromos	185	98	Lapithos. Tomb 428, Plan (1); Sections C-C, B-B, A-A (2—4); Finds in chamber (5); Finds in dromos (6) Tomb 429, Plan (7); Sections B-B, A-A (8, 9); Finds <i>in situ</i> (10). Tomb 601, Plan (11, 12); Sections A-A, C-C, B-B (13—15)	257
71	Lapithos. Tombs 404—405	185	99	Lapithos. Tomb 428. Interior of the chamber with finds <i>in situ</i>	258
72	Lapithos. Tombs 404—405, Plan (1); Sections A-A and B-B (2, 3); Finds <i>in situ</i> (4). Tomb 406, Finds <i>in situ</i> (5); Plan (6); Sections C-C, A-A, B-B (7—9)	195	100	Lapithos. Tomb 428. Interior of the chamber with finds <i>in situ</i>	258
73	Lapithos. Tomb 406, dromos	196	101	Lapithos. Tomb 601, dromos	266
74	Lapithos. Tomb 409, dromos	196	102	Lapithos. Tomb 602 Upper part of Skeleton III with tomb-gifts <i>in situ</i>	266
75	Lapithos. Tomb 407, Plan (1); Sections C-C, B-B, A-A (2—4). Tomb 408, Plan (6); Sections A-A, C-C, B-B, D-D (5, 7—9); Finds in chamber (10); Finds in niche (11)	203	103	Lapithos. Tomb 602. Upper part of Skeleton I with tomb-gifts <i>in situ</i>	269
76	Lapithos. Tomb 409, Plan (1); Sections C-C, B-B, A-A (2—4). Tomb 410, Plan (10); Sections A-A, C-C, D-D, B-B (5—8); Finds in niche (9). Tomb 411, Plan (12); Sections A-A, B-B, C-C (13—15); Finds <i>in situ</i> (11)	211	104	Lapithos. Tomb 603, dromos	269
77	Lapithos. Tomb 412, Plan (1); Sections A-A, B-B (2, 3); Skeletons in dromos (4); Finds <i>in situ</i> (5). Tomb 413, Plan (6); Sections B-B, A-A (7, 8); Finds <i>in situ</i> (9). Tomb 414, Plan (10); Sections C-C, A-A, B-B (11—13)	217			

105	Lapithos. Tomb 601, Finds <i>in situ</i> (1). Tomb 602, Plan (2); Sections B-B, A-A (3, 4); Finds <i>in situ</i> : 1 st. burial period (5) and 2nd burial period (6). Tomb 603, Plan (7); Sections A-A, B-B (8, 9); Finds <i>in situ</i> (10)	270	134	Ajios Jakovos. Bronze Age Sanctuary. View from S. E.	359
106	Kythrea. The site of the Neolithic settlement before excavation	278	135	Ajios Jakovos. Bronze Age Sanctuary. Fragments of incense-burners <i>in situ</i>	359
107	Kythrea. The excavated huts	279	136	Ajios Jakovos. Bronze Age Sanctuary. The sacrificial basin during excavation	360
108	Kythrea. Hut I	280	137	Ajios Jakovos. Bronze Age Sanctuary. Votive offerings surrounding the sacrificial basin	360
109	Kythrea. Hut I. Base for prop supporting the roof	280	138	Ajios Jakovos. Iron Age Sanctuary. View from the North	362
110	Kythrea. Hut II	281	139	Ajios Jakovos. Iron Age Sanctuary. Interior view	362
111	Kythrea. Intersection of Huts I and IV	281	140	Ajios Jakovos. Iron Age Sanctuary. Detail of the house, showing the two cement floors and a jar (No. 69) embedded in the wall	363
112	Kythrea. Hut IV	283	141	Ajios Jakovos. Iron Age Sanctuary. One of the pits	363
113	Kythrea. Hut V	283	142	Nitovikla. The stronghold seen from the West..	372
114	Kythrea. Hut IV during excavation	284	143	Nitovikla. The main southern rampart	373
115	Kythrea. Hut IV. Holes for props supporting the roof	284	144	Nitovikla. The outer gate of the western approach	373
116	Kythrea. Hut IV. Finds <i>in situ</i>	285	145	Nitovikla. Analytical plan of the fortress	374
117	Kythrea. Hut IV. Finds <i>in situ</i>	285	146	Nitovikla. Wall 2, seen from the West	377
118	Ajios Jakovos. View from the Kerynia Mountains. The necropolis is situated to the left of the hillock in the centre	303	147	Nitovikla. Wall 21 and the so-called Northern Casemates from the West	377
119	Ajios Jakovos. Tomb 1, Plan (1); Sections B-B, A-A, C-C (2, 3, 4). Tomb 2, Section C-C (5); Plan (6); Sections A-A, B-B (7, 8). Tomb 3, Sections A-A, B-B (9, 10); Plan (11). Tomb 4, Sections A-A, B-B, C-C (12, 13, 14). Tomb 5, Section A-A (15); Plan (16)	305	148	Nitovikla. Walls 3 and 14 with the monoliths of Walls 4 and 13 (the gate)	378
120	Ajios Jakovos. Melia	307	149	Nitovikla. Base of monolith of Wall 4	378
121	Ajios Jakovos. Tomb 2. Interior view, showing Section C-C	307	150	Nitovikla. The cistern	387
122	Ajios Jakovos. Tomb 1, dromos	310	151	Nitovikla. The angle between Walls 6, 21 and 22 showing the buttress of Wall 6 covered by Wall 22	387
123	Ajios Jakovos. Tomb 2, dromos	310	152	Nitovikla. The Fortress seen from the North	392
124	Ajios Jakovos. Tomb 4, Plan (1). Tomb 6, Finds <i>in situ</i> (2).	316	153	Nitovikla. The fortress seen from within the main fortified area	395
125	Ajios Jakovos. Tomb 6, Plan (1); Sections A-A, B-B, C-C (2, 3, 4). Tomb 7, Plan (5); Sections C-C, A-A, B-B (6, 7, 8); Finds <i>in situ</i> (9).	323	154	Nitovikla. The courtyard. In foreground Wall 39	395
126	Ajios Jakovos. Tomb 8, Plan (1); Sections C-C, A-A, B-B (2, 3, 4). Tomb 9, Plan (5); Sections B-B, A-A (6, 7). Tomb 10, Section C-C (8); Plan (9); Sections A-A, B-B (10, 11)	326	155	Nitovikla. The terrace and the corridor in front of the Northern Casemates, seen from the inner gate	397
127	Ajios Jakovos. Tomb 8, Finds <i>in situ</i> of the first and second periods (1), and of the third period (2)	329	156	Nitovikla. The tower and the store-room at the eastern rampart, seen from the inner gate	397
128	Ajios Jakovos. Tomb 8, Finds Nos. 1—7 <i>in situ</i>	330	157	Nitovikla. Reconstructed sketch, showing the courtyard and surrounding buildings during Period III A	400
129	Ajios Jakovos. Tomb 10, dromos	330	158	Nitovikla. Reconstructed sketch, showing a view of the Fortress during Period III A	402
130	Ajios Jakovos. Tomb 11, Section A-A (1); Plan (2). Tomb 12, Sections A-A, C-C, B-B (3, 4, 5); Plan (6). Tomb 13, Section B-B (7); Plan (8); Section A-A (9). Tomb 14, Plan (10); Sections A-A, D-D, B-B, C-C (11, 12, 13, 14)	344	159	Nitovikla. Tomb 1, Plan (1); Sections B-B, A-A (2,3); Finds <i>in situ</i> (4). Tomb 2, Plan (5); Sections A-A, B-B (6,7); Finds <i>in situ</i> (8). Tomb 3, Plan (9); Section A-A (10)	411
131	Ajios Jakovos. Tomb 6. Interior view with finds <i>in situ</i>	350	160	Paleoskoutella. The hill of the necropolis seen from the South	417
132	Ajios Jakovos. Tomb 14. Interior view with skeletons <i>in situ</i>	350	161	Paleoskoutella. Tumulus 1 before excavation ..	418
133	Ajios Jakovos. Tomb 13, Finds <i>in situ</i> (1). Tomb 14, Finds <i>in situ</i> (2)	351	162	Paleoskoutella. The cult place found below Tumulus 1	418
			163	Paleoskoutella. Tumulus 1. Plan of tumulus (1); Section E-E (2); Plan of excavated area (3); Sections B-B, A-A, C-C, D-D (4, 5, 6, 7). Tumulus 2, Plan (8); Sections A-A, B-B (9, 10). Tumulus	

	3, Plan (11); Sections A-A, B-B (12, 13). Tumulus 4, Sections C-C, B-B (14, 15); Plan of tumulus (16); Section A-A (17)	420		(3); Sections A-A, B-B (3, 4); Finds <i>in situ</i> (5). Tomb 5, Plan (6); Sections A-A, B-B, C-C, D-D, E-E (7, 8, 9, 10, 11). Tomb 6, Sections D-D, B-B, C-C (12, 13, 14); Plan (15); Section A-A (16) . .	488
164	Paleoskoutella. Tumulus 1. The communicating cavities 15 and 16	422	192	Enkomi. Tomb 3, dromos	492
165	Paleoskoutella. Tumuli 2 and 3 before excavation	422	193	Enkomi. Tomb 7, dromos	492
166	Paleoskoutella. Tumulus 4, Plan of tomb with finds <i>in situ</i> (1). Tumulus 5, Plan (2); Section A-A (3). Tumulus 6, Plan (4); Sections A-A, B-B (5, 6). Tumulus 7, Plan of tumulus (7); Plan of tomb (8); Sections C-C, D-D, B-B, A-A (9, 10, 11, 12)	427	194	Enkomi. Tomb 6, Finds <i>in situ</i> (1). Tomb 7, Plan (2); Sections C-C, A-A, B-B (3, 4, 5); Reconstructive section (6). Tomb 8, Plan (7); Sections A-A, B-B (8, 9). Tomb 9, Plan (10); Sections A-A, B-B (11, 12)	497
167	Paleoskoutella. View of the necropolis from top of Tumulus 7	430	195	Enkomi. Tomb 8. Finds <i>in situ</i> (1). Tomb 10, Plan (2); Sections A-A, B-B, C-C (3, 4, 5); Finds <i>in situ</i> (6). Tomb 11, Plan (7, 8); Section B-B (9)	501
168	Paleoskoutella. Tumulus 7 before excavation	430	196	Enkomi. Tomb 10, dromos	506
169	Paleoskoutella. Tomb of Tumulus 5	431	197	Enkomi. Tomb 10. Interior view with section remaining, and finds <i>in situ</i>	506
170	Paleoskoutella. The trench through Tumulus 7	431	198	Enkomi. Tomb 11, Section A-A (1); Finds of first, second, and third periods <i>in situ</i> (2, 3, 4)	511
171	Paleoskoutella. Tomb of Tumulus 7 with finds <i>in situ</i>	433	199	Enkomi. Tomb 11 A.	515
172	Tumulus 7. Chamber with finds <i>in situ</i>	437	200	Enkomi. Tomb 13. Interior view with finds <i>in situ</i>	515
173	Tumulus 7. Tomb seen towards the dromos	437	201	Enkomi. Tomb 12, Plan (1); Sections A-A, B-B, C-C (2, 3, 4); Inner face of door-packing (5). Tomb 13, Plan (6); Sections A-A, B-B, C-C, D-D, E-E (7, 8, 9, 10, 11); Finds <i>in situ</i> (12, 13)	527
174	Kountoura Trachonia. Tomb 2, dromos	441	202	Enkomi. Tomb 13. Interior view with finds <i>in situ</i>	537
175	Kountoura Trachonia. Tomb 8, dromos	441	203	Enkomi. Tomb 14 with finds and skeletons <i>in situ</i>	537
176	Kountoura Trachonia. Tomb 1, Plan (1); Sections A-A, B-B (2, 3). Tomb 2, Plan (4); Sections B-B, A-A (5, 6); Finds <i>in situ</i> (7). Tomb 3, Plan (8); Sections A-A, B-B (9, 10). Tomb 4, Plan (11); Section A-A (12). Tomb 5, Plan (13); Sections B-B, A-A (14, 15). Tomb 6, Sections A-A, C-C, B-B (16, 17, 18); Plan (19). Tomb 7, Plan (20)	444	204	Enkomi. Tomb 14, Plan (1); Section A-A (2). Tomb 15 (3). Tomb 16 (4). Tomb 17, Plan (5); Sections B-B, A-A (6, 7); Finds <i>in situ</i> , lower layer (8); upper layers (9)	539
177	Kountoura Trachonia. Tomb 7. Interior view	449	205	Enkomi. Tomb 15. Finds and skeleton <i>in situ</i>	542
178	Kountoura Trachonia. Tomb 8. Interior view	449	206	Enkomi. Tomb 17. Finds of the upper layer <i>in situ</i>	542
179	Kountoura Trachonia. Tomb 7, Sections A-A, B-B, C-C (1, 2, 3). Tomb 8, Plan (4); Sections A-A, B-B, C-C, (5, 6, 7). Tomb 9, Plan (8); Section A-A (9). Tomb 11, Plan (10); Sections A-A, B-B (11, 12). Tomb 12, Plan (13); Sections A-A, B-B (14, 15). Tomb 14, Plan (16); Sections A-A, B-B (17, 18). Tomb 13, Plan (19); Sections A-A, B-B, (20, 21)	451	207	Enkomi. Tomb 18, dromos	547
180	Kountoura Trachonia. Tomb 9	457	208	Enkomi. Tomb 18. Finds and skeletons <i>in situ</i>	547
181	Kountoura Trachonia. The tumulus of Tomb 15	457	209	Enkomi. Tomb 18, Plan (1); Sections A-A, B-B, C-C (2-4); Finds <i>in situ</i> (7). Tomb 22, Plan (5); Section D-D (6)	549
182	Kountoura Trachonia. Tomb 15, Plan (1); Section A-A (2). Trachonas. The built tomb, Section B-B (3); Plan (4); Architectural plan (5) and section (6); Sections A-A, C-C, D-D (7, 8, 9)	462	210	Enkomi. Tomb 18 during excavation	550
183	Trachonas. The dromos	463	211	Enkomi. Tomb 18, Side-chamber. Finds <i>in situ</i>	550
184	Trachonas. The dromos seen from the doorway	463	212	Enkomi. Tomb 19, Finds <i>in situ</i> (1, 2)	561
185	Trachonas. Interior view	465	213	Enkomi. Tomb 19, Plan (1); Sections A-A, B-B, C-C (2, 3, 4). Tomb 20, Plan (5); Sections A-A, B-B (6, 7). Tomb 21, Plan (8); Sections A-A, C-C, B-B (9, 10, 11)	569
186	Trachonas. The reliefs above the entrance	465	214	Enkomi. Tomb 19. Finds <i>in situ</i>	572
187	Enkomi. The necropolis	468	215	Enkomi. Tomb 21. The stomion seen from within	572
188	Enkomi. Tomb 1, Plan (1); Section A-A (2). Tomb 2, Plan (3); Sections B-B, A-A (4, 5); Finds <i>in situ</i> , first period (6); second period (7). Tomb 3, Plan (8); Sections A-A, B-B (9, 10)	469	216	Ajios Jakovos. The Bronze Age Sanctuary, Cylinder No. 12	576
189	Enkomi. Tomb 2. Interior view	471	217	Ajios Jakovos. Inscription on the cylinder	576
190	Enkomi. Tomb 5	471			
191	Enkomi. Tomb 3, Finds <i>in situ</i> (1). Tomb 4, Plan				

L I S T O F P L A N S

PLAN I.

Map of Cyprus.

PLAN II.

1. Petra tou Limniti. General Field Plan.
2. Kythrea. General Field Plan.
3. Enkomi. General Field Plan.

PLAN III.

1. Lapithos. General Field Plan.
2. Lapithos, Plakes. Detailed Field Plan.

PLAN IV.

1. Paleoskoutella. General Field Plan.
2. Nitovikla. General Field Plan.

PLAN V.

1. Lapithos, Vrysi tou Barba. Detailed Field Plan.
2. Lapithos, Kastros. Detailed Field Plan.
3. Ajos Jakovos. Detailed Field Plan.
4. Enkomi. Detailed Field Plan.

PLAN VI.

1. Petra tou Limniti. Architectural Plan.
2. Petra tou Limniti. Sections I—III.

PLAN VII.

1. Petra tou Limniti. Sections IV—VI.
2. Petra tou Limniti. Sections VII—IX.

PLAN VIII.

1. Lapithos, Eastern Settlement. Architectural Plan.
2. Lapithos, Eastern Settlement. Sections I, II.

PLAN IX.

1. Lapithos, Eastern Settlement. Sections III—V.
2. Lapithos, Eastern Settlement. The Hearth, Plan and Section.

PLAN X.

1. Lapithos, Western Settlement. Architectural Plan.
2. Lapithos, Western Settlement. Sections I—III.

PLAN XI.

1. Lapithos, Western Settlement. Sections IV, V.
2. Lapithos, Western Settlement. Sections VI—XIV.

PLAN XII.

1. Kythrea, Neolithic Settlement. Architectural Plan.
2. Kythrea, Neolithic Settlement. Sections I, II.

PLAN XIII.

1. Ajos Jakovos, The Bronze Age Sanctuary. Architectural Plan.
2. Ajos Jakovos, The Bronze Age Sanctuary. Sections C-C, B-B, A-A.

PLAN XIV.

1. Ajos Jakovos, The Iron Age Sanctuary. Architectural Plan.
2. Ajos Jakovos, The Iron Age Sanctuary. Sections I, II.

PLAN XV.

1. Nitovikla, The Fortress. Architectural Plan.
2. Nitovikla, The Fortress. Sections I—III.
3. Nitovikla, The Fortress. Northern façade of Wall 2.

PLAN XVI.

1. Nitovikla, The Fortress. Sections IV—VI.
2. Nitovikla, The Fortress. Eastern façade of Walls 14, 13, 4, 3, 2.
3. Nitovikla, The Fortress. Southern façade of Wall 4.
4. Nitovikla, The Fortress. Northern façade of Wall 13.

L I S T O F P L A T E S I

PL. I.

Pottery. Base-ring II Ware (E. 3. 195); Black Slip II Ware (L. 702. 57); Red Polished II Ware (L. 309 A. 32, L. 308. 13); Red Polished I Ware (L. 303 A. 5).

PL. II.

Pottery. Light-on-Dark Ware (P. 7. 27); White Painted III Ware (L. 316. 117); White Slip I Ware (E. 3. 166); Levanto-Helladic Ware (E. 3. 261); Red-on-Black Ware (P. 7. 109).

PL. III.

Gold objects. Earrings (E. 11. 39); Necklace with haematite cylinder (Ajos Jakovos, Bronze Age Sanctuary, 3+4+27); Necklace (E. 3. 281); Engraved finger-ring (E. 18. 62).

PL. IV.

Gold objects. Plaques (L. 417. 13, 14, 1, 15); Disc (L. 428. 10); Earrings (L. 420. 21); Necklace (L. 420. 20+22 a).

PL. V.

1. Petra tou Limniti. Objects of flint, obsidian, stone, and bone.
2. Petra tou Limniti. Flints.

PL. VI.

1. Petra tou Limniti. Stone objects.
2. Petra tou Limniti. Objects of stone and flint.

PL. VII.

Petra tou Limniti. Stone bowls, plates, and grinders.

PL. VIII.

1. Petra tou Limniti. Idol No. 42.
2. Petra tou Limniti. Idol No. 72.
3. Petra tou Limniti. Front of Idol No. 27.
4. Petra tou Limniti. Back of Idol No. 27.

PL. IX.

1. Lapithos, Neolithic Settlement. Objects of flint and steatite.
2. Lapithos, Neolithic Settlement. Axe-heads and chisels of stone.

PL. X.

1. Lapithos, Neolithic Settlement. Plain White and Red Polished Wares.
- 2-4. Lapithos, Neolithic Settlement. Painted Ware.

PL. XI.

- 1—3. Kythrea. Flints.
4. Kythrea. Objects of horn and flint.

PL. XII.

Kythrea. Pottery, Red Polished Ware.

PL. XIII.

1. Kythrea. Idol of steatite.
2. Kythrea. Minor objects.
3. Kythrea. Stone objects.

PL. XIV.

1. Lapithos, Tomb 301 A. Pottery.
9, 11, 10, 1, 7, 12, 2.
2. Lapithos, Tomb 301 C. Bronze objects.
3. Lapithos, Tomb 303 B. Pottery.
6, 9, 8, 4, 7.
4. Lapithos, Tomb 303 A. Pottery.
18, 5, 11, 3, 21
9, 7, 17, 19, 14, 1
13, 10, 12, 8, 6, 20, 15, 4, 16, 2.

PL. XV.

1. Lapithos, Tomb 302 A. Pottery.
1, 34, 32, 4, 16
7, 10, 3, 20, 2, 8
17, 22, 33, 29, 13, 26, 42, 24, 23, 5
21, 14, 18, 27, 6, 19, 28, 31, 15, 9, 11, 25, 12, 39.
2. Lapithos, Tomb 302 A. Objects of bronze and terracotta.

PL. XVI.

1. Lapithos, Tomb 302 B. Pottery.
22, 10, 14, 1
31, 9, 20, 16, 40, 11
46, 19, 36, 4, 45, 48, 8, 50, 51
13, 49, 6, 32, 52, 3, 17, 7, 30, 29, 28, 43, 44
37, 47, 18, 21, 41, 42, 39, 12, 5, 2, 15, 38.
2. Lapithos, Tomb 302 B. Objects of bronze and stone.

PL. XVII.

1. Lapithos, Tomb 302 C. Pottery.
26, 12, 30, 1
15, 14, 8, 33, 9
25, 20, 13, 10, 5, 2
3, 35, 17, 22, 23, 19, 27, 7, 24, 37
18, 32, 31, 11, 34, 4, 6, 21, 28, 39, 36.
2. Lapithos, Tomb 302 C. Objects of bronze and terracotta

PL. XVIII.

1. Lapithos, Tomb 306 A. Pottery.
18, 14, 19, 9, 21, 10, 17, 13
16, 8, 7, 15, 5, 1, 6, 20, 3.
2. Lapithos, Tomb 306 C. Pottery
14, 10, 1, 3, 16, 17
7, 9, 18, 4, 2, 11, 15, 6, 5, 12, 8.
3. Lapithos, Tomb 306 A. Objects of bronze, terracotta, and faience.

PL. XIX.

1. Lapithos, Tomb 307 A. Pottery.
10, 1, 8, 23, 15, 5, 16, 3, 13, 7, 9
14, 4, 20, 6.
2. Lapithos, Tomb 307 A. Objects of bronze, silver-lead, and terracotta.
3. Lapithos, Tomb 307 B. Objects of bronze and terracotta.
4. Lapithos, Tomb 307 B. Pottery.
Cupboard 3: 2, 1, 3, Cupboard 1: 1.
Cupboard 2: 1, Chamber: 15, 16, 7, 6, 11, 8, 2, 17, 10, 3, 4, 5.
5. Lapithos, Tomb 308. Pottery.
12, 17, 13, 16, 22
3, 23, 14, 28, 1, 7
19, 4, 25, 24, 26, 11
9, 5, 21, 27, 15, 20, 2, 18, 8, 6, 10.

PL. XX.

1. Lapithos, Tomb 309 A. Pottery.
14, 4, 5, 28, 2
37, 3, 15, 44, 16, 32, 33
31, 17, 6, 18, 19, 35, 25, 24
45, 30, 29, 40, 34, 23, 47, 1, 13, 36, 43, 26
9, 22, 20, 41, 39, 38, 49, 48, 27, 7, 8, 21, 10.
2. Lapithos, Tomb 309 A. Objects of bronze and terracotta.

PL. XXI.

1. Lapithos, Tomb 309 B. Pottery.
6, 23, 22, 3, 26
9, 16, 2, 36, 24, 1
33, 8, 19, 14, 40, 35, 10, 7, 32, 42
29, 28, 30, 25, 21, 11, 27, 34, 20, 37, 31, 17
12, 15, 39, 41, 4, 38, 13.
2. Lapithos, Tomb 309 B. Minor objects.

PL. XXII.

1. Lapithos, Tomb 311 A. Pottery.
45, 3, 16, 20, 6, 10
7, 41, 19, 13, 12, 14, 2, 46, 9, 27
44, 39, 37, 24, 8, 22, 31, 4, 25, 35, 38, 40
36, 26, 30, 34, 18, 1, 11, 28, 21, 23, 15, 5.
2. Lapithos, Tomb 311 A. Objects of bronze and terracotta.
3. Lapithos, Tomb 311 B. Pottery.
3, 7, 13, 18, 15, 10, 2
4, 12, 1, 20, 14, 5, 8, 6, 19, 17, 16, 9, 21.

PL. XXIII.

1. Lapithos, Tomb 312 A. Pottery.
1, 5, 4, 7, 3, 2, 6
Lapithos, Tomb 312 B. Pottery.
2, 1.
2. Lapithos, Tomb 313 A. Minor objects.
3. Lapithos, Tomb 313 A. Daggers and swords of bronze.

PL. XXIV.

1. Lapithos, Tomb 313 A. Scrapers and knives of bronze.
2. Lapithos, Tomb 313 B. Bronze objects.
3. Lapithos, Tomb 313 C—D. Objects of bronze and terracotta: lump of iron.
4. Lapithos, Tomb 313 C—D. Bronze objects

PL. XXV.

1. Lapithos, Tomb 313 A. Pottery.
86, 56, 112, 111
24, 85, 25, 26, 47, 114, 48, 87, 71, 22, 113
84, 31, 27, 45, 88, 42, 34, 94, 41, 46, 109, 44, 28.
2. Lapithos, Tomb 313 A. Objects of bronze, terracotta, stone, and flint.

PL. XXVI.

1. Lapithos, Tomb 313 B. Pottery.
51, 16, 56, 14, 13, 1, 80, 2, 29, 35
53, 67, 82, 79, 101, 37-61, 58, 70, 83, 26, 17
22, 59, 47, 34, 15, 28, 23, 41, 90, 24, 30, 19
69, 52, 27, 49, 77, 36, 54, 81.
2. Lapithos, Tomb 313 B. Objects of terracotta and faience

PL. XXVII.

1. Lapithos, Tomb 313 C-D. Pottery.
19, 2, 20, 9-10, 11
22, 13, 34, 3, 40, 15, 14, 21, 8, 37
36, 12, 16, 24, 26, 18, 41, 25, 1, 23, 35, 38.
2. Lapithos, Tomb 314 A. Pottery.
12, 2, 6, 16, 15, 25, 8
4, 1, 21, 13, 22, 20, 10
5, 23, 9, 14, 3, 19, 18.
3. Lapithos, Tomb 314 A. Bronze knife.
4. Lapithos, Tomb 314 B. Objects of bronze, terracotta, and stone.

PL. XXVIII.

- Lapithos, Tomb 314 B. Pottery.
23, 5, 59, 79, 58, 51, 11, 18, 13, 41
8, 78, 47, 44, 74, 1, 9, 89, 3, 4
— — — — — 43, 26, 45, 7, 12, 88, 10
— — — — — 14, 84, 36, 24, 56, 83, 29, 72, 40
49, 90, 46, 81, 73, 65, 6, 70, 17, 34, 27, 63, 71, 64, 42, 75
37, 82, 19, 67, 57, 30, 20, 55, 35, 15, 52
2, 50, 60, 53, 76, 28, 77, 66, 54.

PL. XXIX.

1. Lapithos, Tomb 315 A. Pottery.
75, 66, 9, 25, 21, 52, 44, 16, 5, 73, 40, 53
6, 43, 78, 26, 77, 62, 39, 54, 30, 88, 14, 86, 59, 93, 97, 46
11, 94, 85, 10, 2, 51, 45, 36, 50, 22, 58, 29, 91, 18, 92, 24, 7, 70, 4, 74, 95, 67, 1
20, 19, 8, 48, 68, 35, 15, 23, 34, 13, 27, 72, 61.
2. Lapithos, Tomb 315 A. Objects of bronze, terracotta, and stone

PL. XXX.

1. Lapithos, Tomb 315 B-C. Pottery
34, 39, 46, 7, 8, 23, 30, 24, 18, 6, 27, 5, 45, 31
Dromos (Dr.) Cupboard: 2, 3, 1, Chamber: 2, 1, 48, 17, 22, 26, 44, 29, 25, 35, 49.
2. Lapithos, Tomb 315 B-C. Objects of bronze and terracotta.

PL. XXXI.

1. Lapithos, Tomb 316. Pottery.
11, 136, 44, 179, 140, 77, 42, 57, 74, 19, 24, 45, 32, 137, 153
1, 10, 56, 149, 152, 34, 176, 35, 178, 54, 107, 55, 102, 79, 73, 16, 8, 124
6, 14, 121, 147, 108, 127, 182, 95, 85, 4, 5, 104, 117, 81, 93, 50, 43, 138, 46, 51, 130

- 154, 86, 145, 128, 12, 118, 61, 122, 64, 150, 120, 126, 144, 106, 21, 60, 15, 148, 98, 30, 67, 27, 29, 3
 13, 183, 114, 162, 181, 31, 26, 184, 125, 180, 18, 78, 119, 25, 134, 66, 52, 72, 131, 87, 75, 37, 9, 97, 23, 68, 2, 132, 7
 36, 161, 53, 41, 33, 71, 69, 28, 105, 22, 70, 39, 38, 133, Cupboard 2: 2, Cupboard 1: 1, Cupboard 2: 1, Cupboard 1: 2.
2. Lapithos, Tomb 316. Minor objects from chamber and cupboard (C.-b.).

PL. XXXII.

1. Lapithos, Tomb 316. Bronze objects.
 2. Lapithos, Tomb 317. Pottery.
 12, 3, 4, 10, 5, 13, 9, 7, 2, 6, 8.
 3. Lapithos, Tomb 318. Pottery.
 21, 11, 9, 22, 17, 10
 12, 5, 1, 26, 20, 4, 6, 23, Dromos: 2, Chamber: 25, 3, 8, 2.
 4. Lapithos, Tomb 317. Bronze pins.
 5. Lapithos, Tomb 318. Objects of bronze and terracotta.
 6. Lapithos, Tomb 319 A. Bronze pin.
 7. Lapithos, Tomb 319 B. Minor objects.

PL. XXXIII.

- Lapithos, Tomb 319 B and C. Pottery.
 Chamber B: 45, 36, 33, 62, 19, 10, 18, 51, 27, 35, 59
 23, 53, 30, 15, 12, 56, 6, 34, 9, 28, 14, 54, 13, 48, 58
 17, 8, 3, 29, 37, 43, 40, 2, 38, 5, 61, 50, 26, 42, 52
 46, 16, 32, 39, 60, 31, 55, 44, 21, 7, 20, 41, 11, 25, 49
 Chamber C: 4, 8, 7, 11, 2, 6, 1, 9, 5, 3.

PL. XXXIV.

1. Lapithos, Tomb 320. Pottery.
 119, 150, 127, 72, 49, 117, 44, 115, 120, 146, 27
 151, 112, 76, 42, 67, 88, 24, 123, 111, 135, 31, 25, 48, 23, 47, 108
 30, 64, 82, 133, 74, 79, 28, 87, 109, 66, 35, 32, 73, 41, 68, 105
 99, 43, 106, 113, 33, 129, 86, 107, 83, 130, 128
 Dromos (Dr.) Cupboard 1: 1, 3: 1, 1: 2, 2: 1, Chamber: 110, 26, 38, 89, 63, 36, 29, 85, 65, 39, 34.
 2. Lapithos, Tomb 320. Minor objects from chamber and cupboards (C.-b).
 3. Lapithos, Tomb 320. Objects of bronze and terracotta.

PL. XXXV.

1. Lapithos, Tomb 322 A. Pottery.
 64, 13, 27, 46, 45, 47, 49, 65, 25, 26, 24.
 2. Lapithos, Tomb 322 A. Objects of bronze, silver, gold etc.
 3. Lapithos, Tomb 322 A. Axe-heads, knives, and pins of bronze.

PL. XXXVI.

1. Lapithos, Tomb 322 B. Pottery.
 33, 20, 22, 37, 24, 25, 31
 8, 9, 27, 23, 14 a, 7, 28, 18, 6, 29.
 2. Lapithos, Tomb 322 B. Necklace of faience.
 3. Lapithos, Tomb 322 B. Objects of bronze, silver-lead, and terracotta.
 4. Lapithos, Tomb 322 D. Minor objects.

PL. XXXVII.

1. Lapithos, Tomb 322 D. Pottery.
 53, 43, 86, 52, 3, 42, 51
 96, 5, 61, 40, 73, 39, 95, 28, 66, 41, 27, 25, 93
 72, 20, 21, 69, 67, 14, 12, 79, 92, 65, 18
 81, 9, 11, 89, 76, 80, 38, 19, 78, 60, 8, 45, 57, 26
 33, 36, 77, 44, 55, 48, 64, 94, 50, 74, 47, 82, 13, 49

- 46, 22, 75, 24, 85, 30, 29, 68, 58, 10, 71, 83, 35, 62, 59
70, 15, 16, 1, 7, 6, 54, 63, 23, 56.
2. Lapithos, Tomb 322 E. Minor objects.
 3. Lapithos, Tomb 322 E. Spindle-whirls of terracotta.

PL. XXXVIII.

Lapithos, Tomb 322 E. Pottery.

113, 28, 112, 27
88, 97, 51, 93, 96, 39, 100, 30, 98, 21
59, 52, 107, 45, 20, 89, 13, 8
16, 19, 65, 117, 26, 109, 108, 78, 111
110, 92, 41, 104, 83, 101, 42, 77, 11, 95, 5, 91, 84, 62
94, 18, 6, 4, 22, 1, 55, 56, 57, 69, 66, 50, 87, 9, 58, 40, 75, 76
116, 44, 37, 38
2, 3, 99, 81, 68, 67, 115, 29, 54, 73, 25
23, 10, 71, 36, 43, 82, 61, 60, 24, 63
70, 106, 53, 114, 64, 72, 12.

PL. XXXIX.

1. Lapithos, Tomb 323 A. Pottery.
1, 2.
2. Lapithos, Tomb 323 B. Pottery.
2, 1.
3. Lapithos, Tomb 323 D. Objects of bronze and terracotta.
4. Lapithos, Tomb 323 D. Pottery.
6, 5, 11, 12, 1, 3, 4.
5. Lapithos, Tomb 323 C. Pottery.
1, 14, 10, 5, 16, 9, 17, 18, 8
11, 4, 19, 3, 12, 15, 20, 7, 13, 2.
6. Lapithos, Tomb 323 C. Sword and pins of bronze.
7. Lapithos, Tomb 701. Pottery.
22, 19, 21, 16, 15, 1, 2, 18, 8, 11, 13, 9, 3, 2, 6, 17
25, 20, 14, 5, 26, 27, 28, 7, 4, 10.

PL. XL.

Lapithos, Tomb 702. Pottery.

112, 88, 101, 155, 32, 24, 75, 143, 66, 107, 109, 108, 28, 100
151, 38, 89, 67, 150, 73, 71, 90, 13, 57, 29, 85, 62, 152, 59, 64
145, 56, 139, 134, 47, 94, 61, 69, 144, 147, 50, 115, 79, 60, 46, 86, 65
10, 22, 12, 21, 1, 15, 18, 58, 77, 42, 70, 8, 74, 7, 43, 106, 36, 37, 39, 51, 111
25, 125, 149, 76, 84, 105, 17, 27, 95, 124, 35, 30, 16, 136, 49, 113, 26, 117, 55, 20, 5, 2, 4, 68, 3, 153
31, 54, 154, 129, 97, 137, 80, 87, 48, 96, 72
6, 40, 19, 81, 14, 99, 9, 41, 23, 93, 114, 52, 98, 11, 82, 148, 92, 63, 53, 83.

PL. XLI.

1. Lapithos, Tomb 401. Pottery.

45, 36, 47, 11, 35, 49, 97
--- -- -- -- 13, 103, 102, 104, 112, 83
22, 16, 28, 20, 26, 19, 30
--- -- -- -- 74, 70, 66, 106, 101, 98, 92, 94
1, 43, 14, 29, 23, 25
--- -- -- -- 76, 65, 50, 75, 82, 108, 111, 9, 72, 51, 68
6, 105, 100, 61, 54, 55, 67, 63, 48, 81, 7, 71, 52, 18, 64, 73, 8, 3, 27, 107
85, 99, 31, 96, 10, 53, 95, 88, 109, 21, 84, 110
93, 113, 4, 87, 86, 78, 89, 24, 57, 77, 90, 15, 79
2, 41, 69, 33, 46, 44, 40, 38, 42, 34, 17, 39, 80, 62, 32, 91, 56.

2. Lapithos, Tomb 401. Minor objects.

PL. XLII.

1. Lapithos, Tomb 402. Pottery.
42, 31, 9, 10, 37, 3, 30, 11
41, 43, 27, 33, 8, 16, 29, 14, 48, 47
21, 49, 7, 20, 4, 25, 38
12, 40, 6, 2, 32, 34, 13, 18, 24, 15
39, 22, 28, 5, 36, 26, 19, 23, 17.
2. Lapithos, Tomb 402. Minor objects.
3. Lapithos, Tomb 403. Minor objects.
4. Lapithos, Tomb 403. Incense-burner.

PL. XLIII.

Lapithos, Tomb 403. Pottery.

121, 22, 149, 150, 15, 103
130, 152, 28, 20, 25, 7, 100, 52, 11, 30
16, 8, 153, 81, 86, 62, 125, 18, 61, 68, 19
85, 135, 116, 43, 98, 133, 134, 118, 64, 10, 101, 60, 139, 137, 80, 111, 84, 113, 74
129, 106, 108, 73, 76, 63, 42, 53, 110, 124, 17, 54, 78, 114, 65, 117
142, 13, 87, 120, 75, 136, 79, 131
14, 58, 6, 102, 69, 67, 141, 26
56, 59, 71, 145, 12, 144, 82, 105, 128, 55, 9, 109
88, 29, 70, 77, 146, 66, 115, 27, 132, 24, 45, 138, 83, 112
127, 148, 107, 143, 31, 151, 147, 72, 44, 119.

PL. XLIV.

1. Lapithos, Tomb 403. Gold objects.
2. Lapithos, Tombs 404 and 405. Pottery.
Tomb 404: 14, 11, 8, 6, 2, 7, 13, 5, 4
1, 12, 10, 9, 3, 15, 16, Tomb 405: 1.

PL. XLV.

1. Lapithos, Tomb 406. Pottery.
35, 49, 71, 95, 96, 54, 10, 6, 12
7, 47, 70, 56, 92, 18, 100, 93, 68, 8, 13, 67, 52
62, 45, 23, 5, 24, 65, 76, 75, 11, 90, 53, 55
77, 66, 74, 22, 73, 25, 72, 21, 27, 26
42, 37, 78, 46, 34, 91, 30, 64, 80, 79, 43
32, 69, 81, 3, 94, 98, 84, 99, 31
48, 41, 51, 2, 82, 19, 57, 59, 61, 39, 4, 83, 88, 63
87, 38, 28, 89, 20, 58, 85, 86, 36, 50, 44, 29.
2. Lapithos, Tomb 407. Pottery.
1, 2, 4, 5.

PL. XLVI.

1. Lapithos, Tomb 406. Minor objects.
2. Lapithos, Tomb 408. Minor objects.
3. Lapithos, Tomb 408. Bronze bowl and stone cover.
4. Lapithos, Tomb 408. Pottery.
37, 63, 74, 7, 76, 42, 79, 47
38, 11, 61, 44, 64, 71, 3, 23, 18, 15, 43, 72
28, 83, 8, 29, 58, 75, 46, 5, 20, 53, 56, 59, 82
78, 48, 31, 25, 55, 62, 6, 69, 30, 45, 50, 10, 26
80, 16, 70, 40, 17, 57, 32, 33, 21, 13, 67, 34, 66, 14, 39
12, 41, 54, 2, 24, 81, 4, 22, 35, 73, 36, 60
Niche: 5, 6, 4, 1, 3, 2.

PL. XLVII.

1. Lapithos, Tomb 409. Bronze bowl.
2. Lapithos, Tomb 409. Pottery.
(From top) 11, 8, 4.
3. Lapithos, Tomb 409. Gold objects.
4. Lapithos, Tomb 409. Objects of iron and bronze.
5. Lapithos, Tomb 410. Pottery.
1, 4, 3, 5, 6, 2.

PL. XLVIII.

1. Lapithos, Tomb 411. Pottery.
6, 15, 13, 2, 11, 1, 20, 3, 14
9, 31, 29, 28, 5, 10, 12, 7, 4, 8, 17, 19, 16, 18, 30, 33.
2. Lapithos, Tomb 411. Objects of iron, bronze, and bone.
3. Lapithos, Tomb 412. Pottery.
5, 8, 13, 12, 10, 7, 11, 9, 6
1, 3, 14, 15, 16, 2, 4.

PL. XLIX.

1. Lapithos, Tomb 413. Pottery.
33, 13, 11, 12, 52, 37, 23, 24, 6, 27, 54, 8
17, 21, 22, 40, 10, 34, 9, 53, 49, 14, 26, 25, 7
43, 30, 29, 51, 16, 47, 18, 56, 28
35, 42, 46, 45, 41, 50, 39, 15, 32, 36, 20, 44, 31, 57.
2. Lapithos, Tomb 413. Bronze bowls.
3. Lapithos, Tomb 413. Minor objects.
4. Lapithos, Tomb 415. Terracotta statuette.
5. Lapithos, Tomb 419. Terracotta statuette.

PL. L.

- Lapithos, Tomb 417. Pottery.
108, 84, 87, 72, 94, 129, 101
55, 37, 43, 107, 56, 24, 45, 40, 59, 38, 102, 21, 105
19, 31, 49, 50, 83, 62, 18, 103, 44, 51, 41, 36, 29, 64
52, 68, 66, 54, 110, 77, 78, 67, 90, 117, 121, 34
96, 127, 69, 119, 91, 85, 76, 118, 116, 134, 133, 115, 28, 89, 100, 23
120, 109, 114, 60, 81, 124, 122
123, 57, 97, 126, 98, 75, 125
63, 88, 61, 113, 39, 46, 128, 48, 58, 47, 32, 104, 33
71, 95, 70, 79, 93, 112, 22, 20, 26, 131, 27, 73
82, 65, 86, 30, 132, 106, 80, 130, 25, 53, 42, 74, 111, 35.

PL. LI.

1. Lapithos, Tomb 417. Objects of bronze and iron.
2. Lapithos, Tomb 417. Minor objects of gold, bronze, and bone.

PL. LII.

- Lapithos, Tomb 420. Pottery.
81, 59, 68, 12, 80, 67, 89, 87, 91, 57, 26, 75
29, 34, 63, 3, 61, 5, 58, 71, 64, 9, 88, 42, 33, 32, 49, 84, 6
27, 77, 60, 66, 4, 7, 56, 31, 44, 36, 62, 1, 30, 37, 8, 51, 72
52, 92, 74, 85, 83, 13, 76, 86, 39, 48, 38, 93, 82, 90, 94, 78, 28
50, 53, 11, 35, 54, 65, 10, 40, 69, 73, 41, 70, 55, Niche: 1, 2.

PL. LIII.

1. Lapithos, Tomb 420. Objects of iron, bronze, and stone.
2. Lapithos, Tomb 420. Objects of gold, bronze, and bone.

PL. LIV.

1. Lapithos, Tomb 421. Pottery.
5, 2, 1, 3.
2. Lapithos, Tomb 422. Pottery.
Dromos: 2, 1, Chamber: 9, 13, 8.
3. Lapithos, Tomb 422. Iron pike.
4. Lapithos, Tomb 422. Objects of gold and rock-crystal.
5. Lapithos, Tomb 422. Minor objects.
6. Lapithos, Tombs 423 and 424. Pottery.
Tomb 423: 2, 1, Tomb 424: 1.
7. Lapithos, Tomb 427. Pottery.
3, 4, 5, 2, 1.

PL. LV.

1. Lapithos, Tomb 425. Pottery.
43, 42, 41, 24, 34, 27, 31, 30, 39, 38
25, 40, 28, 32, 36, 35, 37, 33, 26.
2. Lapithos, Tomb 425. Gold objects.
3. Lapithos, Tomb 425. Minor objects.
4. Lapithos, Tomb 425. Bronze bowl.

PL. LVI.

1. Lapithos, Tomb 428. Pottery.
78, 14, 11, 15, 31, 44, 74, 29, 16, 40, 43, 37, 81, 75, 32, 62, 79
33, 65, 68, 39, 30, 70, 50, 52, 49, 56, 63
46, 42, 53, 67, 38, 51, 73, 47, 57, 59, 58, 76, 72, 77
17, 80, 36, 35, 60, 64, 54, 69, 45, 55, 34, 61, 41, 48, 71, 66
13, 12, 5, 3, 1, 2, 6, 82.
2. Lapithos, Tomb 428, Dromos. Pottery.
4, 5, 6, 2, 3, 1.

PL. LVII.

1. Lapithos, Tomb 429. Pottery.
24, 2, 5, 9, 32, 14, 39, 34, 23, 26, 22, 28, 4, 1, 3, 11, 15
13, 7, 10, 20, 18, 19, 16, 27, 31, 17, 21, 33, 6, 29, 8, 30.
2. Lapithos, Tomb 428. Minor objects.
3. Lapithos, Tomb 428. Gold objects.
4. Lapithos, Tomb 429. Objects of iron, bronze, and bone.

PL. LVIII.

1. Lapithos, Tomb 601. Pottery.
19, 18, 5, 1, 11, 17, 15, 2, 16, 10
9, 6, 14, 3, 12, 8, 7.
2. Lapithos, Tomb 603. Pottery.
14, 1, 15, 4, 10, 2, 5, 8, 11
13, 16, 7, 12, 3, 6.
3. Lapithos, Tomb 601. Objects of bronze and iron.
4. Lapithos, Tomb 603. Bronze fibula.

PL. LIX.

1. Lapithos, Tomb 602. Pottery.
8, 2, 4, 22, 9, 20, 55
56, 53, 58, 59, 50, 46, 1, 3, 63, 61, 35, 64, 49, 70
11, 17, 95, 12, 44, 31, 80, 99
92, 34, 100, 93, 91, 67, 57, 65, 48, 45

XXXVIII

89, 90, 15, 13, 16, 88, 81, 14, 79
74, 71, 78, 72, 75, 69, 77, 94, 68, 73, 76, 66
29, 54, 96, 33, 25, 47, 42, 24, 38, 19, 5, 30, 62, 60, 32
84, 85, 83, 97, 39, 52, 98, 87, 18, 28, 36, 21, 103, 6, 10, 37, 86, 82.

2. Lapithos, Tomb 602. Objects of iron, bronze, and bone.

PL. LX.

1. Ajios Jakovos, Tomb 1. Pottery.

10, 5, 13, 2, 6, 11, 1, 7, 3, 4, 9, 8, 12.

2. Ajios Jakovos, Tomb 2. Pottery.

10, 2, 6, 11, 5, 9, 4, 3.

3. Ajios Jakovos, Tombs 4 A and B. Pottery.

Tomb 4 B: 6, 5, 4, 3, 8, 7, 9, 2, 1. Tomb 4 A: 3, 5, 6, 7, 2, 1, 4.

4. Ajios Jakovos, Tomb 7. Pottery.

18, 16, 10, 12, 3

1, 9, 11, 6, 8, 5

13, 14, 4, 20, 15, 7.

5. Ajios Jakovos, Tomb 4 B. Bronze pin.

6. Ajios Jakovos, Tomb 7. Objects of bronze and stone.

PL. LXI.

Ajios Jakovos, Tomb 6. Pottery.

133, 4, 2, 12, 114, 9

135, 61, 16, 117, 3, 86, 5, 53, 31, 43, 112, 63, 11, 79, 120, 64, 47

1, 18, 94, 13, 78, 30, 20, 73, 67, 132, 130, 33, 68, 147, 116

69, 46, 34, 23, 76, 100, 39, 95, 111, 85, 90, 7, 17, 48, 44, 27, 157, 72, 57, 45, 70, 125

89, 110, 24, 105, 14, 59, 137, 6, 29

51, 93, 36, 42, 129, 150, 32, 74, 115, 107

58, 87, 102, 83, 25, 106, 101, 92, 35, 134, 88, 28, 19

10, 119, 123, 84, 56, 21, 113, 26, 138, 60, 65, 118, 80, 41, 158

109, 126, 127, 124, 159, 96, 8, 22, 52, 98, 75, 37, 131, 54, 40

149, 97, 136, 66, 49, 148, 121, 62, 82, 71.

PL. LXII.

1. Ajios Jakovos, Tomb 6. Minor objects.

2. Ajios Jakovos, Tomb 8. Pottery.

38, 34, 17, 11, 36, 29, 27, 30

62, 3, 16, 68, 37, 15, 69, 4

7, 71, 33, 19, 8, 35, 6, 18, 12, 64

54, 55, 28, 1, 31, 40, 2, 5, 56, 14, 9, 10, 80, 70

72, 73, 79, 63, 78, 43, 61, 42, 59, 45, 23, 48, 81, 41

49, 92, 83, 87, 51, 50, 21, 25, 24, 20, 47

44, 26, 46. Tomb 9: 2, 3, 1, 5.

PL. LXIII.

1. Ajios Jakovos, Tomb 8. Minor objects.

2. Ajios Jakovos, Tomb 10 A. Pottery.

8, 12, 1, 10, 7, 17, 18, 16, 11, 15, 5, 9.

3. Ajios Jakovos, Tomb 10 A. Objects of bronze and stone.

4. Ajios Jakovos, Tomb 12. Pottery.

27, 41, 19, 4, 30, 26, 37, 14, 22, 8, 29, 1

5, 6, 11, 12, 32, 31, 20, 17, 13, 2, 3, 21, 18, 33, 24.

5. Ajios Jakovos, Tomb 12. Minor objects.

6. Ajios Jakovos, Tomb 12. Necklace of faience.

PL. LXIV.

1. Ajios Jakovos, Tomb 13. Pottery.
28, 14, 27, 22, 23, 31
29, 19, 21, 26, 16, 2, 6
15, 20, 41, 24, 3, 1, 7, 30, 8
13, 37, 42, 4, 5, 17, 9, 34, 38, 18, 39, 33, 40, 35.
2. Ajios Jakovos, Tomb 13. Minor objects.

PL. LXV.

1. Ajios Jakovos, Tomb 14. Pottery.
13, 23, 22, 14, 2, 15, 20, 11, 21
4, 12, 3, 1, 5, 17, 40, 25, 6
26, 29, 45, 33, 16, 47, 51, 46, 32, 41, 49, 28
48, 53, 34, 37, 35, 36, 39, 44, 52, 30.
2. Ajios Jakovos, Tomb 14. Objects of bronze, terracotta, faience, and stone.

PL. LXVI.

1. Ajios Jakovos, Bronze Age Sanctuary. Pottery.
19, 46, 18, 45, 44
29, 56, 55, 30
54, 57, 40, 58, 59, 31.
2. Ajios Jakovos, Bronze Age Sanctuary. Minor objects.

PL. LXVII.

Ajios Jakovos. Bronze Age Sanctuary. Objects of gold, silver, and haematite.

PL. LXVIII.

Ajios Jakovos, Iron Age Sanctuary. Pottery, statuettes of terracotta, and glyptics.

PL. LXIX.

1. Nitovikla, Tomb 1. Pottery.
40, 28, 22, 24, 17, 23, 9, 4, 5, 35, 8, 34
33, 26, 18, 13, 44, 31, 16, 43, 15, 42, 2, 25, 7.
2. Nitovikla, Tomb 1. Minor objects.
3. Nitovikla, Tomb 2. Pottery.
47, 48, 49, 46, 39, 17, 3, 40, 45, 5, 18
12, 69, 2, 72, 33, 25, 24, 7, 60, 63, 19, 6, 36, 53, 28
1, 32, 21, 20, 56, 13, 61, 64, 57, 37.

PL. LXX.

1. Enkomi. Bichrome crater. Stray find.
2. Paleoskoutella, Tomb 7. Potsherds.
3. Nitovikla. Bichrome potsherds.
4. Ajios Jakovos. Light-on-Dark potsherds.
5. Nitovikla. Fragment of a Coarse Ware stirrup-vase.

PL. LXXI.

1. Paleoskoutella, Tomb 4. Pottery.
10, 14, 7, 11, 8, 9, 3, 2
1, 5, 6, 12, 4.
2. Paleoskoutella, Tomb 7. Pottery (first part).
77, 44, 13, 57, 70, 73, 82
100, 33, 83, 104, 8, 27, 7, 45
110, 29, 95, 39, 20, 31, 105, 46, 21, 96, 97, 14.

PL. LXXII.

Paleoskoutella, Tomb 7. Pottery (second part).

51, 48, 99, 41, 71
 47, 113, 69, 30, 94, 120, 10
 62, 91, 53, 81, 108, 15, 37, 36, 80, 115, 61
 49, 2, 116, 3, 63, 40, 59, 111, 9, 17, 93, 19, 101, 107, 67, 117
 12, 54, 102, 4, 43, 90
 79, 86, 109, 122, 103, 58, 92
 84, 34, 35, 64, 114, 72, 65, 11, 26, 121, 50, 106, 22
 60, 87, 76, 24, 66, 28, 18, 85, 1, 89, 32.

PL. LXXIII.

1. Kountoura Trachonia, Tomb 2. Pottery.
 16, 9, 10, 25, 13, 15, 26, 23, 14, 28
 32, 7, 35, 30, 1, 18, 20, 12, 29, 24, 17, 8, 33, 5, 2, 19, 27, 6
 31, Dromos: 1, Chamber: 11, 21, 22.
2. Kountoura Trachonia, Tomb 3. Pottery.
 14, 9, 12, 10, 8, 1, 4
 13, 3, 7, 2, 5, 15, 11, 16, 6.
3. Kountoura Trachonia, Tomb 4. Pottery.
 1, 2.
4. Kountoura Trachonia, Tomb 5. Pottery.
 1.
5. Kountoura Trachonia, Tomb 6. Pottery.
 4, 1, 2, 3, 5, 7, 6.

PL. LXXIV.

1. Kountoura Trachonia, Tomb 7. Pottery.
 9, 12, 8, 2, 13, 11, 15, 6, 14, 4
 17, 16, 5, 10, 3, 1, 18, 7.
2. Kountoura Trachonia, Tomb 8. Pottery.
 1, 19, 10, 3, 17, 18, 7, 9, 21, 4, 5, 15, 8, 11, 14, 12, 20, 16, 2, 13.
3. Kountoura Trachonia, Tomb 8. Impression of bezel of finger-ring.
4. Kountoura Trachonia, Tomb 11. Pottery.
 1.
5. Kountoura Trachonia, Tomb 12. Pottery.
 2, 10, 16, 1, 11, 12, 8, 6, 14, 15, 13, 7, 9.
6. Kountoura Trachonia, Tomb 14. Pottery.
 8, 10, 5, 4, 7, 6, 1, 2, 3, 9.
7. Kountoura Trachonia, Tomb 12. Bronze coin.

PL. LXXV.

1. Kountoura Trachonia, Tomb 10. Pottery.
 33, 3, 21, 2, 24, 13, 32, 25, 7
 22, 6, 34, 15, 9, 16, 29, 14, 26, 17, 4, 30, 20
 19, 1, 28, 10, 36, 31, 18, 35, 27, 8, 5.
2. Kountoura Trachonia, Tomb 10. Bronze coins.

PL. LXXVI.

1. Enkomi, Tomb 2. Pottery.
 47, 63, 60, 36, 38, 30, 56, 48, 65, 32, 62, 44, 42, 35, 39, 34, 61, 46, 66
 45, 40, 31, 49, 52, 57, 41, 59, 58, 53, 51, 64, 43, 54, 33, 50, 37, 55
 10, 19, 21, 3, 20, 14, 22, 28, 27, 15, 29, 26, 9, 12, 25
 2, 23, 13, 17, 7, 5, 4, 8, 11, 16, 18, 6, 1, 24.
2. Enkomi, Tomb 2. Cylinders of paste and steatite.
3. Enkomi, Tomb 3. Stray finds.

PL. LXXVII.

Enkomi, Tomb 3. Pottery.

72, 279, 164, 259, 262, 263, 269, 4, 268
 76, 168, 218, 60, 188, 169, 27, 201, 28, 61, 271, 200, 214, 12, 270, 171, 115, 24
 20, 227, 126, 212, 213, 116, 118, 122, 204, 14, 217, 68, 25, 185, 69, 125, 226, 228, 128, 7, 34, 58, 211
 13, 63, 21, 207, 206, 191, 64, 190, 40, 16, 62, 19
 39, 176, 67, 17, 38, 165, 1, 66, 266, 210, 43, 22, 70, 29, 121
 265, 2, 10, 11, 78, 119, 183, 35, 79, 33, 8, 170, 196, 222, Dromos Cupboard: 3, 4, 5, 1, 2
 Chamber: 260, 272, 163, 257, 258, 261, 264
 219, 205, 75, 74, 195, 37, 225, 280, 31, 202, 229, 172, 223, 59, 71, 209
 249, 253, 252, 251, 180, 166, 221, 6, 255, 220, 127
 192, 77, 36, 254, 250, 256, 117, 179, 5, 30, 3
 9, 187, 208, 65, 173, 73, 182, 189, 18, 15, 197, 216, 45, 177
 181, 186, 175, 123, 275, 193, 174, 224, 42, 273, 194, 274, 124, 203, 178, 41, 44.

PL. LXXVIII.

1. Enkomi, Tomb 3. Objects of terracotta, faience, glass, and ivory.
2. Enkomi, Tomb 3. Stray finds.
3. Enkomi, Tomb 3. Objects of silver-lead and gold.

PL. LXXIX.

1. Enkomi, Tomb 4. Pottery.

5, 6, 3, 1, 4, 2, 7.

2. Enkomi, Tomb 6. Pottery.

56, 86, 31, 69, 44, 59, 4, 81, 51, 36, 66, 87
 71, 94, 43, 74, 77, 84, 11, 79, 54, 89, 53
 8, 25, 88, 60, 76, 93, 26, 82, 57, 39, 45, 97, 50, 61, 83, 3
 62, 10, 27, 40, 48, 73, 13, 67, 41, 70, 68
 63, 7, 95, 42, 49, 90, 37, 32, 75, 33, 29, 85, 1, 5, 92
 30, 2, 65, 55, 47, 52, 38, 78, 64, 80, 35, 34
 46, 14, 12, 58, 28.

3. Enkomi, Tomb 6. Minor objects of gold, silver, bronze, ivory, paste, and stone.

PL. LXXX.

1. Enkomi, Tomb 8. Pottery.

60, 18, 17, 14, 20, 16, 65, 15, 19, 64
 62, 61, 35, 36, 63, 57, 59, 33, 32, 34, 58, 21.

2. Enkomi, Tomb 8. Gold objects.

3. Enkomi, Tomb 8. Minor objects of silver, bronze, cornelian, and amethyst.

PL. LXXXI.

1. Enkomi, Tomb 10. Pottery.

48, 8, 12, 13, 24, 9, 47, 52, 53, 26
 45, 40, 41, 16, 17, 55, 7, 15, 31, 34, 1, 4, 36, 42, 19
 5, 37, 43, 39, 49, 46, 2, 38, 54, 3, 22, 50, 6, 21, 18
 33, 20, 32, 35, 25, 44, 30, 51.

2. Enkomi, Tomb 10. Minor objects.

3. Enkomi, Tomb 10 A. Pottery.

7, 2, 3, 6, 4, 5, 1, 8.

4. Enkomi, Tomb 12. Pottery.

2, 1.

5. Enkomi, Tomb 15. Pottery.

1, 2, 3.

6. Enkomi, Tomb 15. Ivory box with lid.

7. Enkomi, Tomb 7 A. Pottery.
3, 1, 2, 4.
8. Enkomi, Tomb 7 A. Cylinder of steatite.
9. Enkomi, Tomb 19 A. Pottery and stone bowl.
2, 1.
10. Enkomi, Tomb 14. Pottery and stone bowl.
3, 4, 2, 6, 5.
11. Enkomi, Tomb 14. Necklace and bone tool.
12. Enkomi, Tomb 13. Gold earring.

PL. LXXXII.

Enkomi, Tomb 11. Pottery. First layer.

257, 237, 246, 186, 147, 140, 176, 155, 173, 223, 156, 235, 220, 269, 138, 265, 243, 250, 195
 227, 169, 252, 225, 228, 233, 219, 244, 258, 217, 158, 236, 255, 174, 214, 263, 168, 180
 204, 205, 206, 187, 137, 222, 150, 248, 242, 241, 188, 224, 162, 166, 141, 167, 134, 207
 185, 264, 267, 160, 165, 146, 208, 136, 179, 238, 161, 144, 215, 229, 193, 274, 139, 191, 209, 190, 159, 152, 231, 213, 202, 251
 135, 189, 175, 211, 183, 254, 170, 261, 216, 196, 262, 164, 143
 234, 172, 226, 194, 142, 163, 149, 230, 210, 154, 184, 145, 197, 151, 232, 245, 182
 177, 171, 203, 153, 256, 240, 181, 218, 178, 212, 260, 268, 221.

PL. LXXXIII.

Enkomi, Tomb 11. Pottery. Second and third layers.

82, 71, 62, 52, 81, 157, 132, 74, 69, 73, 88, 63, 83, 53
 72, 78, 68, 59, 133, 66, 128, 57, 58, 51, 61, 129, 79, 70, 65, 80
 87, 67, 85, 131, 130, 49, 125, 60, 126, 127, 84, 76, 56, 55, 50, 48, 124, 89, 86, 75
 77, 64, 47, 54, Dromos: 1.
 Chamber: 6, 118, 8, 5, 33, 24, 29, 31, 95
 23, 109, 122, 28, 104, 21, 92, 19, 103, 111, 105, 17, 10, 90, 91, 115, 97, 117, 102
 106, 101, 113, 30, 108, 18, 25, 11, 112, 12, 26, 14, 15, 27, 9, 110, 93, 120, 123
 16, 99, 20, 121, 98, 32, 96, 94, 13, 114, 7, 119, 116, 100, 1, 2, 3, 270.

PL. LXXXIV.

1. Enkomi, Tomb 11. Objects of gold, paste, lead, and steatite.
2. Enkomi, Tomb 11. Objects of faience and ivory.
3. Enkomi, Tomb 11. Box of wood and ivory (reconstructed); ostrich-egg; bronze bowl.

PL. LXXXV.

Enkomi, Tomb 13. Pottery.

36, 209, 177, 56, 44, 31, 4, 8, 41, 147, 7, 54, 66, 67, 205
 68, 133, 42, 196, 154, 141, 40, 110, 115, 87, 61, 91, 105, 30, 78, 45, 11, 77
 221, 99, 21, 12, 157, 138, 197, 186, 180, 93, 58, 131, 17, 187, 155, 24, 74, 1
 210, 19, 52, 101, 132, 149, 53, 121, 153, 183, 25, 178, 2, 98, 37, 81, 49, 18, 212, 215, 216
 142, 94, 55, 156, 137, 38, 48, 145, 140, 39, 90, 220, 170, 139, 13, 165, 120, 214, 213, 164, 200, 65
 135, 126, 128, 118, 122, 172, 124, 43, 201, 146
 143, 82, 102, 64, 114, 69, 85, 59, 10, 96
 190, 16, 203, 113, 130, 181, 162, 167, 158, 60, 144, 136, 3, 119
 86, 159, 5, 15, 22, 199, 33, 63, 89, 70, 71, 97, 23, 34, 20, 176
 73, 123, 163, 134, 35, 92, 204, 109, 106, 57, 76, 150, 168, 151, 129, 207, 79, 100
 51, 148, 127, 160, 208, 161, 14, 9, 211, 192, 83, 173, 75, 152, 80, 62, 174, 95, 47
 219, 175, 184, 103, 195, 188, 107, 179, 189, 185, 182, 46, 50, 27, 125, 28, 193, 198, 191
 Dromos: 1, Chamber: 171, 169, 32, 108, 84, 112, 29, 72, 88, 104, 111, 202, 206.

PL. LXXXVI.

1. Enkomi, Tomb 16. Pottery.
7, 10, 4, 5, 1, 2, 9, 6, 8.
2. Enkomi, Tomb 16. Minor objects.
3. Enkomi, Tomb 17. Pottery.
49, 90, 3, 57, 37, 4, 32, 33, 44, 36, 27, 94, 16, 12
14, 35, 93, 21, 95, 91, 18, 25, 24, 43, 59, 5, 41, 31, 26, 13
2, 22, 60, 42, 9, 11, 46, 23, 10, 19
47, 51, 15, 88, 20, 92, 29, 54
40, 50, 58, 17, 8, 38, 7, 52, 28
89, 48, 34, 56, 6, 45, 55, 30, 53, 39
1.

PL. LXXXVII.

1. Enkomi, Tomb 17. Objects of gold.
2. Enkomi, Tomb 17. Minor objects.
3. Enkomi, Tomb 20. Pottery.
3, 1, 2, 4.
4. Enkomi, Tomb 22. Pottery.
4, 3, 10, 7, 9, 2, 6, 8, 1, 5.

PL. LXXXVIII.

1. Enkomi, Tomb 18. Pottery.
19, 98, 121, 56, 75, 54, 101, 25, 114, 102, 100, 118, 111, 99, 73
57, 69, 51, 64, 124, 74, 104, 115, 96, 86, 76, 116, 117
34, 123, 79, 80, 63, 26, 87, 32, 35, 67, 52, 49
18, 50, 110.
2. Enkomi, Tomb 18 and Tomb 18, Side-chamber. (S = Side-chamber.) Gold objects.

PL. LXXXIX.

1. Enkomi, Tomb 18. Objects of glass, bronze, and ivory.
2. Enkomi, Tomb 18. Minor objects of silver, bronze, and ivory.
3. Enkomi, Tomb 18. Mortars and pestles of steatite.

PL. XC.

- Enkomi, Tomb 18, Side-chamber. Pottery.
- 44, 45, 46, 6, 47, 50, 43
56, 53, 55, 48, 52, 51, 49, 54, 58
5, 65, 19, 60, 31, 35, 57, 77, 59, 41, 74
71, 76, 20, 40, 21, 63, 64, 33, 26, 25, 32, 61, 4
72, 67, 27, 73, 7, 68, 75, 70, 62, 18
38, 22, 69, 28, 66, 23, 34, 17.

PL. XCI.

- Enkomi, Tomb 19. Pottery.
- 95, 120, 64, 125, 37, 93
135, 73, 72, 140, 22, 3, 19, 127, 26, 27, 103, 84, 141
74, 106, 66, 24, 62, 158, 41, 45
154, 128, 139, 102, 70, 50, 61, 132, 20, 30, 111, 39, 98
114, 99, 124, 129, 18, 119, 14, 5, 89, 90, 85, 97, 67, 88, 65
9, 82, 46, 16, 31, 109, 23
63, 87, 136, 146, 35, 69, 130, 34, 96
150, 134, 71, 149, 57, 94, 148, 123, 118, 25, 143, 101, 131
1, 122, 38, 151, 2, 115, 110, 144, 137, 105, 126
152, 68, 145, 43, 81, 60, 107, 153, 147, 104, 133, 8, 7, 59, 117
100, 86, 47, 33, 108, 44, 142, 42, 21, 113
83, 48, 49, 112, 40, 58, 32, 28, 138, 4, 6, 80.

XLIV

PL. XCII.

1. Enkomi, Tomb 19. Minor objects of gold and terracotta.
2. Enkomi, Tomb 19. Minor objects of silver, bronze, ivory, and stone.
3. Enkomi, Tomb 19. Mortars and pestles of stone. Bowl of faience.

PL. XCIII.

- 1: Reconstruction of flint knife and handle; 2--12: Flint knives, chisel and scrapers; 13: Stone grinder; 14: Stone chisel; 15--17: Stone axe-heads.

PL. XCIV.

Red Polished I Ware.

PL. XCV.

- 1--3: Red Polished I Ware; 4--16: Red Polished II Ware.

PL. XCVI.

Red Polished II Ware.

PL. XCVII.

Red Polished II Ware.

PL. XCVIII.

Red Polished II Ware.

PL. XCIX.

Red Polished III Ware.

PL. C.

Red Polished III Ware.

PL. CI.

Red Polished III Ware.

PL. CII.

- 1--8: Red Polished III Ware; 9--15: Red Polished IV Ware and Red Slip Ware.

PL. CIII.

- 1: Red Polished IV Ware; 2--8: Black Polished Ware; 9--10: Black Slip I Ware.

PL. CIV.

Black Slip II Ware.

PL. CV.

- 1--3: Black Slip III Ware; 4--10: White Painted II Ware.

PL. CVI.

- 1--5: White Painted II Ware; 6--10: White Painted III Ware.

PL. CVII.

White Painted III Ware.

PL. CVIII.

1—5: White Painted III Ware; 6—11: White Painted IV Ware.

PL. CIX.

1—3: White Painted IV Ware; 4—9: White Painted V Ware; 10, 11: Composite Ware; 12—14: Red-on-Black Ware.

PL. CX.

1—7: Red-on-Black Ware; 8—10: Red-on-Red Ware; 11: Light-on-Dark Ware.

PL. CXI.

Plain White Hand-made Ware.

PL. CXII.

1—2: White Shaved Ware; 3—7: Monochrome Ware; 8—16: Base-ring I Ware.

PL. CXIII.

Base-ring II Ware.

PL. CXIV.

1—6: White Slip I Ware; 7—12: White Slip II Ware.

PL. CXV.

1—4: White Slip II Ware; 5: Hand-made Bucchero Ware; 6: Wheel-made Bucchero Ware; 7—8: Red Lustrous Wheel-made Ware; 9—11: Black Lustrous Wheel-made Ware; 12: Black Slip Wheel-made Ware; 13—15: White Painted Wheel-made Ware.

PL. CXVI.

1—3: White Painted Wheel-made Ware; 4—17: Plain White Wheel-made Ware.

PL. CXVII.

1—3: Plain White Wheel-made Ware; 4—15: Levanto-Helladic Ware.

PL. CXVIII.

Levanto-Helladic Ware.

PL. CXIX.

Levanto-Helladic Ware.

PL. CXX.

Levanto-Helladic Ware.

PL. CXXI.

Levanto-Helladic Ware.

PL. CXXII.

White Painted I Ware.

PL. CXXIII.

White Painted I Ware.

XLVI

PL. CXXIV.

White Painted I Ware.

PL. CXXV.

White Painted I Ware.

PL. CXXVI.

White Painted I Ware.

PL. CXXVII.

White Painted I Ware.

PL. CXXVIII.

White Painted I Ware.

PL. CXXIX.

White Painted I Ware.

PL. CXXX.

White Painted I Ware.

PL. CXXXI.

White Painted II Ware.

PL. CXXXII.

White Painted II Ware.

PL. CXXXIII.

1—2: White Painted II Ware; 3—12: White Painted III Ware.

PL. CXXXIV.

1—9: Bichrome I Ware; 10—16: Bichrome II Ware.

PL. CXXXV.

1, 4: Bichrome II Ware; 2, 3, 5—8: Bichrome III Ware; 9—11: Black Slip Painted I Ware; 12: Black Slip Bichrome I Ware.

PL. CXXXVI.

Black-on-Red I (III) Ware.

PL. CXXXVII.

1—8: Black Slip I Ware; 9—12: Black Slip II Ware; 13: Black Slip III Ware; 14—16: Red Slip I (III) Ware.

PL. CXXXVIII.

1: Red Slip Ware; 2—4: Grey Polished Ware; 5—16: Plain White I Ware.

PL. CXXXIX.

1—3, 5, 6: Plain White II Ware; 4, 8—10: Plain White III Ware; 7, 11—16: Coarse Ware; 17—21: Foreign Ware.

PL. CXL.

Hellenistic pottery. Plain White, Black Lustrous, Painted Black Lustrous, and White Painted Wares.

PL. CXLI.

Hellenistic pottery. Plain White Ware.

PL. CXLII.

Bronze objects. 1—4: Swords; 5: Spear-head; 6: Pike; 7—10: Daggers; 11—12: Arrow-heads; 13: Shield-boss; 14—15: Axes.

PL. CXLIII.

Bronze objects. 1—10: Knives; 11—14: Scrapers; 15—16: Awls; 17—19: Tweezers; 20: Chisel; 21: Spatula.

PL. CXLIV.

Bronze objects. 1: Needle; 2—8: Pins; 9: Rings; 10: Earrings; 11: Bracelet; 12: Anklet; 13: Chain; 14: Statuette; 15: Bowl.

PL. CXLV.

Silver objects. 1: Ring; 2: Bracelet; 3: Funnel.

Gold objects. 4—6: Pins; 7: Hair-rings; 8—14: Earrings; 15—23: Finger-rings; 24: Bracelet.

PL. CXLVI.

Gold objects. 1, 2: Strips; 3—6: Diadems.

PL. CXLVII.

Gold objects. 1: Diadem; 2—4: Mouth-pieces; 5—7: Beads; 8—10: Necklaces; 11: Bowl.

PL. CXLVIII.

Idols and animal-shaped vases of terracotta.

PL. CXLIX.

Terracotta. 1—12: Spindle-whirls; 13—17: Lamps; 18: Incense-burner. Faience. 19—21: Necklaces.

PL. CL.

Faience. 1: Drinking cup; 2—3: Bowls; 4: Stirrup vase.

Glass. 5—7: Bottles; 8—17: Impressions of cylinder seals.

PL. CLI.

Stone objects. 1—2: Whetstones; 3—4: Mace-heads; 5—7: Spindle-whirls; 8: Loom-weight; 9—13: Bowls and pestles. 14: Vase of alabaster.

PL. CLII.

Ivory objects. 1—3, 5: Discs; 4: Pin; 6: Comb; 7: Handle; 8—10: Boxes.

PL. CLIII.

1—5: Iron objects; 6—14: Bronze objects.

PL. CLIV.

1—17: Bronze objects; 18—20: Terracotta objects; 21, 22: Faience objects; 23—29: Stone objects; 30—36: Bone objects.

PL. CLV.

Gold objects. 1: Nose-ring; 2—4, 6—9, 11: Earrings; 15, 16, 18—20: Finger-rings; 5, 10, 12, 14: Plaques; 17, 23: Discs; 21: Mounting; 22: Bead; 13: Necklace; 24: Diadem.

L I S T O F P L A T E S I I

- Petra tou Limniti. Pls. V—VIII; XCIII, 1—4, 17.
Lapithos, Neolithic Settlement. Pls. IX; X; XCIII, 5, 6, 14—16.
Kythrea. Pls. XI—XIII; XCIII, 7—13.
Lapithos, Tomb 301 A. Group: Pl. XIV, 1.
Lapithos, Tomb 301 C. Group: Pl. XIV, 2.
Types: Pl. CXLIII, 1, 18.
Lapithos, Tomb 302 A. Group: Pl. XV.
Types: Pls. XCV, 12, 14; XCVI, 1, 6; XCVII, 8; CXLII, 8; CXLIII, 12; CXLIX, 11.
Lapithos, Tomb 302 B. Group: Pl. XVI.
Types: Pls. XCV, 6, 7; XCVI, 3, 5; XCVIII, 13; XCIX, 9, 10.
Lapithos, Tomb 302 C. Group: Pl. XVII.
Types: Pls. XCV, 4, 11; XCVII, 5; XCVIII, 7; C, 5, 9.
Lapithos, Tomb 303 A. Group: Pl. XIV, 4.
Types: Pls. XCIV, 2—5, 8; XCV, 1—3.
Lapithos, Tomb 303 B. Group: Pl. XIV, 3.
Type: Pl. CV, 6.
Lapithos, Tomb 304. Type: Pl. CXLII, 7.
Lapithos, Tomb 306 A. Groups Pl. XVIII, 1, 3.
Types: Pls. XCVIII, 14; CVI, 2; CXLIX, 21.
Lapithos, Tomb 306 C. Group: Pl. XVIII, 2.
Type: Pl. CVI, 4.
Lapithos, Tomb 307 A. Groups: Pl. XIX, 1, 2.
Types: Pls. C, 8; CIII, 2.
Lapithos, Tomb 307 B. Groups: Pl. XIX, 3, 4.
Types: Pls. XCVIII, 10; CI, 1; CIII, 4; CXLVIII, 4.
Lapithos, Tomb 308. Group: Pl. XIX, 5.
Types: Pl. XCIV, 6, 7, 9.
Lapithos, Tomb 309 A. Groups: Pl. XX.
Types: Pls. XCVI, 4; XCVIII, 1, 2, 6, 8, 9; XCIX, 14; C, 4; CI, 4.
Lapithos, Tomb 309 B. Groups: Pl. XXI.
Types: Pls. XCIX, 13; C, 3; CI, 6, 7, 11.
Lapithos, Tomb 311 A. Groups: Pl. XXII, 1, 2.
Types: Pls. XCIX, 1; CV, 4, 5; CVI, 7; CVII, 8.
Lapithos, Tomb 311 B. Group: Pl. XXII, 3.
Types: Pls. C, 10; CIII, 8.
Lapithos, Tomb 312 A and B. Group: Pl. XXIII, 1.
Lapithos, Tomb 313 A. Groups: Pls. XXIII, 2, 3; XXIV, 1; XXV.
Types: Pls. XCVIII, 4; C, 6; CV, 7; CXLII, 1—3, 9; CXLIII, 3—6, 13, 16; CXLIV, 6; CXLVIII, 1—3; CXLIX, 2, 7, 8; CLI, 1, 2.
Lapithos, Tomb 313 B. Groups: Pls. XXIV, 2; XXVI.
Types: Pls. C, 2; CI, 5; CII, 8; CXLIII, 14, 19; CXLIV, 1, 2; CXLIX, 1, 19; CLI, 6.
Lapithos, Tomb 313 C—D. Groups: Pls. XXIV, 3, 4; XXVII, 1.
Types: Pls. XCV, 10, 15; XCIX, 6, 12; CI, 2, 9, 10.
Lapithos, Tomb 314 A. Groups: Pl. XXVII, 2, 3.
Lapithos, Tomb 314 B. Groups: Pls. XXVII, 4; XXVIII.
Types: Pls. XCV, 8, 16; XCVI, 2, 7; XCVII, 4, 7, 9; CII, 1, 5.
Lapithos, Tomb 315 A. Group: Pl. XXIX.
Types: Pls. C, 1; CII, 9; CIII, 1, 5; CVI, 8; CVIII, 3; CXLIII, 2, 21; CXLIV, 5; CLI, 8.
Lapithos, Tomb 315 B—C. Group: Pl. XXX.
Types: Pls. CV, 9, 10; CVI, 9, 10; CVIII, 5; CXLII, 14, 15; CXLIII, 15, 17; CXLVIII, 5, 9, 10.
Lapithos, Tomb 316. Groups: Pls. XXXI; XXXII, 1.
Types: Pls. CII, 14, 15; CIV, 2; CV, 8; CVI, 6; CVII, 1—4, 6, 7, 9—11; CVIII, 1, 2, 4; CXLIII, 10; CXLIV, 9; CXLIX, 3; CLI, 3, 4.
Lapithos, Tomb 317. Groups: Pl. XXXII, 2, 4.
Lapithos, Tomb 318. Groups: Pl. XXXII, 3, 5.
Types: Pls. XCIV, 1; XCVIII, 11; CIII, 3; CXLIV, 4.
Lapithos, Tomb 319 A. Group: Pl. XXXII, 6.
Lapithos, Tomb 319 B. Groups: Pls. XXXII, 7; XXXIII.
Types: Pls. XCVI, 8, 9; XCVII, 1—3; XCIX, 7; CI, 3; CII, 4; CVI, 5.
Lapithos, Tomb 319 C. Group: Pl. XXXIII.
Lapithos, Tomb 320. Groups: Pl. XXXIV.
Types: Pls. CIV, 11; CXLII, 10; CXLIV, 3, 7; CXLIX, 4—6; CLI, 7.
Lapithos, Tomb 322 A. Groups: Pl. XXXV.
Types: Pls. CXLIII, 11, 20; CXLV, 15.
Lapithos, Tomb 322 B. Groups: Pl. XXXVI, 1—3.
Types: Pls. CII, 3; CXLIX, 20.
Lapithos, Tomb 322 D. Groups: Pls. XXXVI, 4; XXXVII, 1.
Types: Pls. XCIX, 4, 8; C, 7; CII, 6, 7; CVI, 3.
Lapithos, Tomb 322 E. Groups: Pls. XXXVII, 2, 3; XXXVIII.
Types: Pls. XCV, 5, 9, 13; XCVII, 6; XCVIII, 3, 5; XCIX, 3, 5, 11; CIII, 6, 7; CXLIX, 9, 10, 12.

- Lapithos, Tomb 323 A. Group: Pl. XXXIX, 1.
 Type: Pl. XCVIII, 12.
- Lapithos, Tomb 323 B. Group: Pl. XXXIX, 2.
- Lapithos, Tomb 323 C. Groups: Pl. XXXIX, 5, 6.
 Type: Pl. CI, 8.
- Lapithos, Tomb 323 D. Groups: Pl. XXXIX, 3, 4.
- Lapithos, Tomb 701. Group: Pl. XXXIX, 7.
 Type: Pl. CXV, 6.
- Lapithos, Tomb 702. Group: Pl. XL.
 Types: Pls. CIV, 1, 6—9, 12; CVII, 5.
- Lapithos, Tomb 401. Groups: Pl. XLI.
 Types: Pls. CXXIII, 4; CXXX, 13; CXXXI, 9; CXXXII, 7; CXXXIII, 1; CXXXVII, 9; CXXXVIII, 2; CXXXIX, 3, 18, 19; CLIV, 22.
- Lapithos, Tomb 402. Groups: Pl. XLII, 1, 2.
 Types: Pls. CXXVI, 12; CXXXI, 1, 15; CXXXII, 1, 5, 6; CXXXIII, 6; CXXXIV, 10; CXXXV, 4, 8; CXXXVI, 4; CXXXVII, 10; CXXXIX, 5, 10, 15; CLIV, 11.
- Lapithos, Tomb 403. Groups: Pls. XLII, 3, 4; XLIII; XLIV, 1.
 Types: Pls. CXXXI, 3, 8, 12, 13; CXXXII, 4; CXXXIII, 2, 3, 5, 7, 8, 10, 12; CXXXIV, 15; CXXXV, 5—7; CXXXVI, 3, 6, 7; CXXXVII, 5, 11, 12, 15, 16; CXXXVIII, 1, 3, 4; CXXXIX, 2, 4, 6, 8, 9, 13; CLIII, 10; CLIV, 4, 18, 21, 26, 27, 31, 33; CLV, 8, 10, 12, 14, 15, 21.
- Lapithos, Tomb 404. Group: Pl. XLIV, 2.
 Types: Pls. CXXXIII, 9; CXXXV, 2; CXXXIX, 1, 14.
- Lapithos, Tomb 405. Group: Pl. XLIV, 2.
- Lapithos, Tomb 406. Groups: Pls. XLV, 1; XLVI, 1.
 Types: Pls. CXXII, 4, 8, 10; CXXIII, 6—8; CXXIV, 1, 3—7; CXXV, 4, 5; CXXVI, 5, 9, 10; CXXVII, 1, 3, 6; CXXVIII, 1; CXXIX, 2; CXXX, 1, 2, 6, 10; CXXXIV, 3, 6; CXXXV, 11, 12; CXXXVII, 7; CXXXVIII, 14; CXXXIX, 12; CLIII, 11; CLIV, 2, 3, 20; CLV, 1.
- Lapithos, Tomb 407. Group: Pl. XLV, 2.
- Lapithos, Tomb 408. Groups: Pl. XLVI, 2—4.
 Types: Pls. CXXII, 12; CXXV, 9; CXXVI, 3, 4, 6; CXXVII, 2, 11; CXXVIII, 7; CXXIX, 3; CXXX, 9; CXXXI, 2, 10, 14, 16; CXXXII, 2; CXXXIV, 7, 12; CXXXV, 1; CXXXVII, 3, 6, 8; CXXXVIII, 12, 13; CXXXIX, 16; CLIV, 24.
- Lapithos, Tomb 409. Groups: Pl. XLVII, 1—4.
 Types: Pls. CXXVII, 12; CLIII, 14; CLIV, 6, 8, 10, 13, 17; CLV, 6, 16.
- Lapithos, Tomb 410. Group: Pl. XLVII, 5.
 Types: Pls. CXXXV, 3; CXXXVI, 2, 8, 10.
- Lapithos, Tomb 411. Groups: Pl. XLVIII, 1, 2.
 Types: Pls. CXXIX, 1; CXXXI, 4, 6; CXXXII, 8; CXXXIV, 5, 8; CLIII, 1, 2, 5,
- Lapithos, Tomb 412. Group: Pl. XLVIII, 3.
 Type: Pl. CXXVI, 7.
- Lapithos, Tomb 413. Groups: Pl. XLIX, 1—3.
 Types: Pls. CXXVII, 7; CXXIX, 4; CXXXI, 11; CXXXIV, 13, 16; CXXXVIII, 16; CXXXIX, 7, 11, 17; CLIV, 14, 19, 28, 29, 35.
- Lapithos, Tomb 415. Group: Pl. XLIX, 4.
- Lapithos, Tomb 417. Groups: Pls. L; LI.
 Types: Pls. CXXII, 5; CXXIV, 9, 11; CXXV, 1—3, 8; CXXVI, 2, 11; CXXVII, 4, 5, 8—10, 13; CXXVIII, 2, 4—6; CXXX, 4; CXXXVIII, 8, 11, 15; CXXXIX, 20, 21; CLIII, 12, 13; CLIV, 1, 12, 32; CLV, 4, 5, 18, 19.
- Lapithos, Tomb 419. Group: Pl. XLIX, 5.
- Lapithos, Tomb 420. Groups: Pls. LII; LIII.
 Types: Pls. CXXII, 1—3; CXXIII, 2, 3, 9—12; CXXIV, 2, 8, 10; CXXV, 6, 7, 10, 11; CXXVI, 8; CXXVIII, 3; CXXX, 3, 5, 7, 11, 12; CXXXIV, 1, 2, 4, 9; CXXXVII, 1, 2, 4; CXXXVIII, 5, 6, 9, 10; CLIII, 3; CLIV, 5, 7, 15, 23, 36; CLV, 3, 7, 9, 13, 20, 22.
- Lapithos, Tomb 421. Group: Pl. LIV, 1.
 Type: Pl. CXXXIII, 11.
- Lapithos, Tomb 422. Groups: Pl. LIV, 2—5.
 Types: Pls. CXXXVI, 5, 9; CLIV, 25; CLV, 11, 17.
- Lapithos, Tombs 423 and 424. Group: Pl. LIV, 6.
- Lapithos, Tomb 425. Groups: Pl. LV.
 Types: Pls. CXXVI, 1; CXXXVIII, 7; CLIV, 16, 34; CLV, 2, 24.
- Lapithos, Tomb 427. Group: Pl. LIV, 7.
 Type: Pl. CXXXVI, 1.
- Lapithos, Tomb 428. Groups: Pls. LVI; LVII, 2, 3.
 Types: Pls. CXXII, 6, 7, 9; CXXXI, 5, 7; CXXXIII, 4; CXXXV, 9; CXXXVII, 13, 14; CLIII, 6, 9; CLV, 23.
- Lapithos, Tomb 429. Groups: Pl. LVII, 1, 4.
 Types: Pls. CXXXII, 3; CLIII, 4.
- Lapithos, Tomb 601. Groups: Pl. LVIII, 1, 3.
 Types: Pls. CXXII, 11; CXXXIV, 11, 14; CLIII, 8.
- Lapithos, Tomb 602. Groups: Pl. LIX.
 Types: Pls. CXXXIII, 5; CXXIX, 5; CXXX, 8; CXXXV, 10; CLIII, 7; CLIV, 9, 30.
- Lapithos, Tomb 603. Groups: Pl. LVIII, 2, 4.
 Types: Pls. CXXXIII, 1; CXXIX, 6.
- Ajios Jakovos, Tomb 1. Group: Pl. LX, 1.
 Type: Pl. CVIII, 7.
- Ajios Jakovos, Tomb 2. Group: Pl. LX, 2.
 Type: Pl. CVIII, 6.
- Ajios Jakovos, Tomb 4 A. Group: Pl. LX, 3.
 Type: Pl. CVIII, 8.
- Ajios Jakovos, Tomb 4 B. Groups: Pl. LX, 3, 5.
 Types: Pls. CVIII, 10; CIX, 2.
- Ajios Jakovos, Tomb 6. Groups: Pls. LXI; LXII, 1.
 Types: Pls. XCIX, 2; CII, 2, 11—13; CIII, 9; CIV, 3—5, 13; CV, 1; CVI, 1; CIX, 4, 5, 11; CXLII, 13.
- Ajios Jakovos, Tomb 7. Groups: Pl. LX, 4, 6.
 Types: Pls. CVIII, 9; CXI, 10.
- Ajios Jakovos, Tomb 8. Groups: Pls. LXII, 2; LXIII, 1.
 Types: Pls. CV, 2; CXII, 1, 3, 6, 10, 12; CXV, 4, 14; CXVI, 4, 6, 14; CXVII, 2; CXIX, 3, 10, 11, 15; CXLIII, 8, 9; CXLIV, 11; CL, 14.
- Ajios Jakovos, Tomb 9. Group: Pl. LXII, 2.
 Type: Pl. CIX, 1.
- Ajios Jakovos, Tomb 10 A. Groups: Pl. LXIII, 2, 3.
- Ajios Jakovos, Tomb 12. Groups: Pl. LXIII, 4—6.
 Types: Pls. CII, 10; CIV, 10.
- Ajios Jakovos, Tomb 13. Groups: Pl. LXIV.
 Types: Pls. CIX, 10; CXII, 2; CXIV, 7; CXV, 9; CXVII, 1; CL, 6.

- Ajios Jakovos, Tomb 14. Groups: Pl. LXV.
Types: Pls. CIX, 7; CXVI, 12; CXLII, 4, 5; CXLIII, 7; CXLVIII, 6, 11.
- Ajios Jakovos. Bronze Age Sanctuary. Groups: Pls. LXVI; LXVII.
Types: Pls. CXLII, 6, 11, 12; CXLIV, 13, 14; CXLV, 1—3, 7, 8, 20; CXLVII, 9; CXLIX, 18; CL, 7—10; CLI, 14.
- Ajios Jakovos. Iron Age Sanctuary. Pl. LXVIII.
- Ajios Jakovos, Potsherds: Pl. LXX, 4.
- Nitovikla, Tomb 1. Groups: Pl. LXIX, 1, 2.
Type: Pl. CXLIV, 8.
- Nitovikla, Tomb 2. Group: Pl. LXIX, 3.
Types: Pls. CVIII, 11; CX, 4; CXII, 11, 15.
- Nitovikla, Postherds: Pl. LXX, 3, 5.
- Paleoskoutella, Tomb 4. Group: Pl. LXXI, 1.
Type: Pl. CXI, 11.
- Paleoskoutella, Tomb 7. Groups: Pls. LXXI, 2; LXXII.
Types: Pls. CIII, 10; CIX, 12—14; CX, 1—3, 5—11; CXI, 1, 2, 6, 7; CXV, 10.
Potsherds: Pl. LXX, 2.
- Kountoura Trachonia, Tomb 2. Group: Pl. LXXIII, 1.
Types: Pls. CXL, 1, 2, 5, 7, 13; CXLI, 8.
- Kountoura Trachonia, Tomb 3. Group: Pl. LXXIII, 2.
Types: Pls. CXLI, 3; CXLIX, 15.
- Kountoura Trachonia, Tomb 4. Group: Pl. LXXIII, 3.
- Kountoura Trachonia, Tomb 5. Group: Pl. LXXIII, 4.
- Kountoura Trachonia, Tomb 6. Group: Pl. LXXIII, 5.
- Kountoura Trachonia, Tomb 7. Group: Pl. LXXIV, 1.
Types: Pl. CXLI, 7, 9, 10.
- Kountoura Trachonia, Tomb 8. Groups: Pl. LXXIV, 2, 3.
Types: Pls. CXL, 8; CXLI, 2, 4, 6.
- Kountoura Trachonia, Tomb 10. Groups: Pl. LXXV.
Types: Pls. CXL, 3, 6, 10, 11, 14; CXLI, 1.
- Kountoura Trachonia, Tomb 11. Group: Pl. LXXIV, 4.
- Kountoura Trachonia, Tomb 12. Groups: Pl. LXXIV, 5, 7.
Types: Pls. CXL, 4; CXLIX, 16.
- Kountoura Trachonia, Tomb 14. Group: Pl. LXXIV, 6.
Types: Pls. CXL, 9, 12; CXLI, 5; CXLIX, 14, 17.
- Enkomi, Tomb 2. Groups: Pl. LXXVI, 1, 2.
Types: Pls. CXII, 9, 13; CXIII, 3, 6; CXIV, 3, 4, 6; CXVI, 15; CL, 11, 15.
- Enkomi, Tomb 3. Groups: Pls. LXXVI, 3—LXXVIII.
Types: Pls. CXIII, 1, 4, 7—9; CXIV, 5, 8—12; CXV, 3; CXVII, 7; CXVIII, 8, 11; CXIX, 4, 5, 16; CXX, 1; CXXI, 1—5, 7; CXLV, 10, 13, 14, 16—18; CXLVI, 1, 2; CXLVII, 5, 7, 10; CXLVIII, 7; CL, 4; CLII, 4.
- Enkomi, Tomb 4. Group: Pl. LXXIX, 1.
Type: Pl. CXII, 5.
- Enkomi, Tomb 6. Groups: Pl. LXXIX, 2, 3.
Types: Pls. CXI, 3—5, 9; CXIII, 12; CXVI, 3, 5, 7—11, 13; CXVII, 5, 8, 11—13; CXVIII, 2, 3; CXIX, 7, 8, 12; CLII, 2.
- Enkomi, Tomb 7 A. Groups: Pl. LXXXI, 7, 8.
Types: Pls. CXVI, 16; CL, 12.
- Enkomi, Tomb 8. Groups: Pl. LXXX.
Types: Pls. CXVI, 2; CXLV, 6; CXLVII, 6.
- Enkomi, Tomb 10. Groups: Pl. LXXXI, 1, 2.
Type: Pl. CXI, 8.
- Enkomi, Tomb 10 A. Group: Pl. LXXXI, 3.
- Enkomi, Tomb 11. Groups: Pls. LXXXII—LXXXIV.
Types: Pls. CXIII, 5, 10; CXV, 8; CXXI, 6; CXLIV, 15; CXLV, 9, 11, 24; CXLVI, 3, 4; CXLVII, 4; CL, 1, 13, 16; CLII, 8, 10.
- Enkomi, Tomb 12. Group: Pl. LXXXI, 4.
- Enkomi, Tomb 13. Groups: Pls. LXXXI, 12; LXXXV.
Types: Pls. CXII, 4, 8, 14; CXIII, 2, 11; CXV, 1, 11; CXVII, 6, 9; CXLIX, 13; CL, 2.
- Enkomi, Tomb 14. Groups: Pls. LXXXI, 10, 11.
Types: Pls. CXV, 5; CLI, 13.
- Enkomi, Tomb 15. Groups: Pl. LXXXI, 5, 6.
- Enkomi, Tomb 16. Groups: Pl. LXXXVI, 1, 2.
Type: Pl. CXVI, 17.
- Enkomi, Tomb 17. Groups: Pls. LXXXVI, 3; LXXXVII, 1, 2;
Types: Pls. CXIII, 13; CXV, 7; CXIX, 13, 14; CXX, 3, 4; CXLV, 4, 5; CXLVII, 11; CL, 17; CLII, 1.
- Enkomi, Tomb 18. Groups: Pls. LXXXVIII; LXXXIX.
Types: Pls. CXVII, 4; CXIX, 1; CXLIV, 12; CXLV, 22, 23; CXLVI, 5, 6; CXLVII, 2, 3, 8; CL, 5; CLI, 11, 12; CLII, 3, 5, 6, 9.
- Enkomi, Tomb 18, Side-chamber. Groups: Pls. LXXXVIII, 2; XC.
Types: Pls. CXVII, 10; CXVIII, 1, 4, 6, 7, 10; CXIX, 6, 9; CXX, 2; CXLV, 21; CXLVII, 1; CL, 5.
- Enkomi, Tomb 19. Groups: Pls. XCI; XCII.
Types: Pls. CV, 3; CIX, 3, 6, 8; CXII, 7, 16; CXIV, 1, 2; CXV, 2, 12, 13, 15; CXVI, 1; CXVII, 3, 14, 15; CXVIII, 5, 9; CXIX, 2; CXLIV, 10; CXLV, 12, 19; CXLVIII, 8; CL, 3; CLI, 5, 9, 10; CLII, 7.
- Enkomi, Tomb 19 A. Group: Pl. LXXXI, 9.
- Enkomi, Tomb 20. Group: Pl. LXXXVII, 3.
Type: Pl. CIX, 9.
- Enkomi, Tomb 22. Group: Pl. LXXXVII, 4.
- Enkomi. Stray find: Pl. LXX, 1.

THE SWEDISH
CYPRUS EXPEDITION

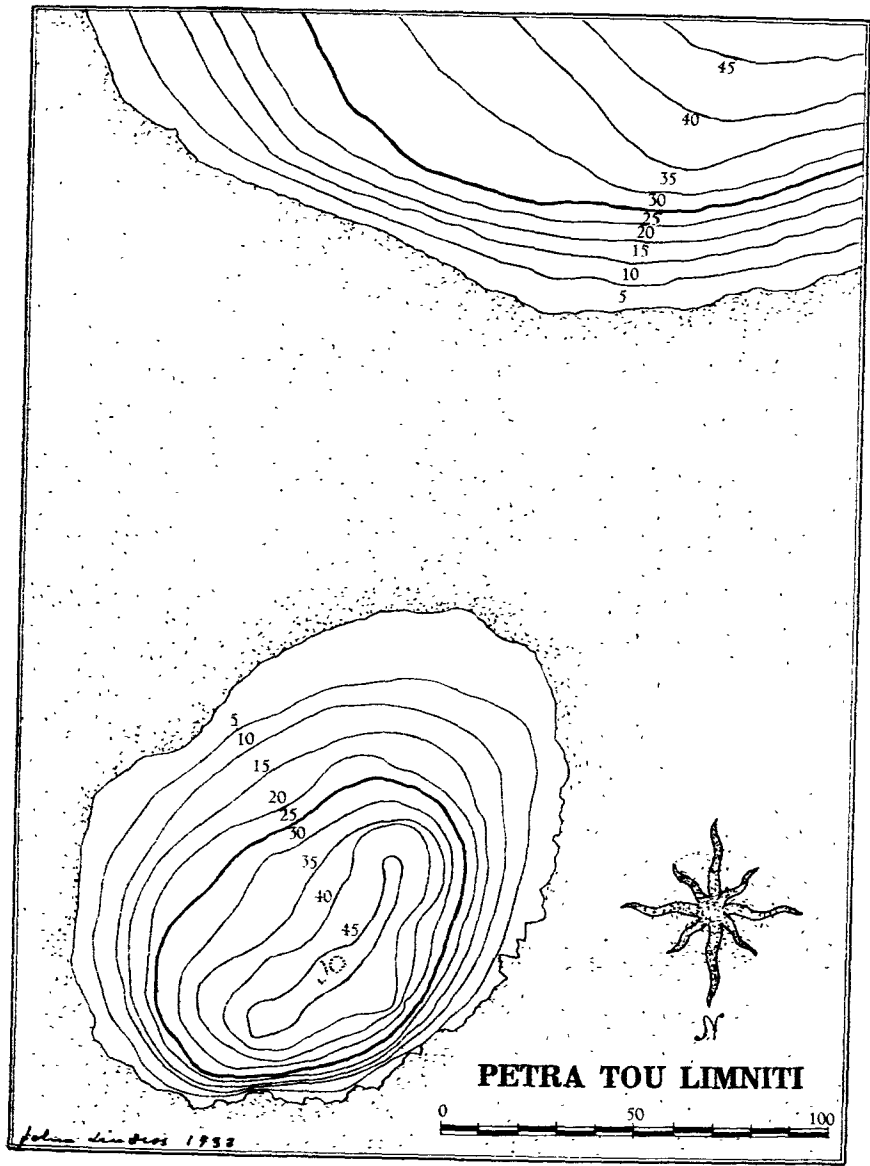

1

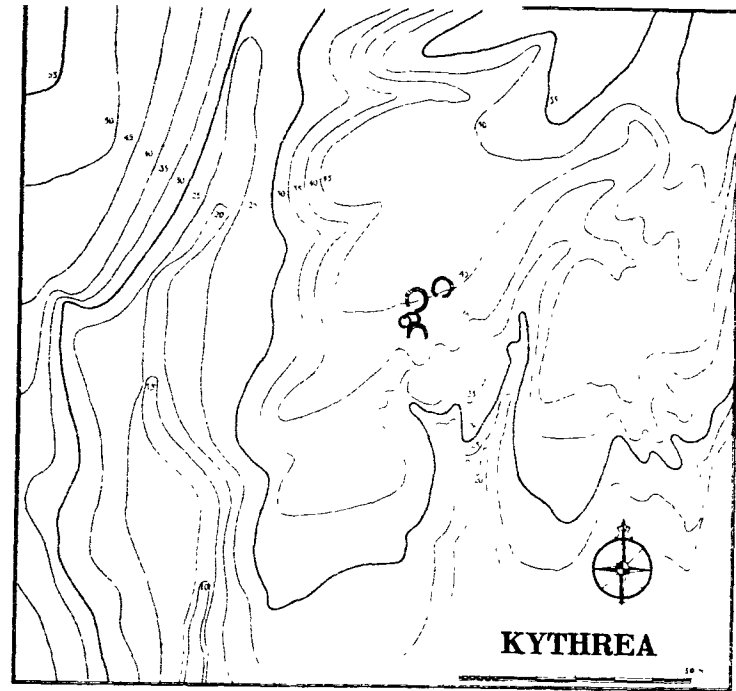

2

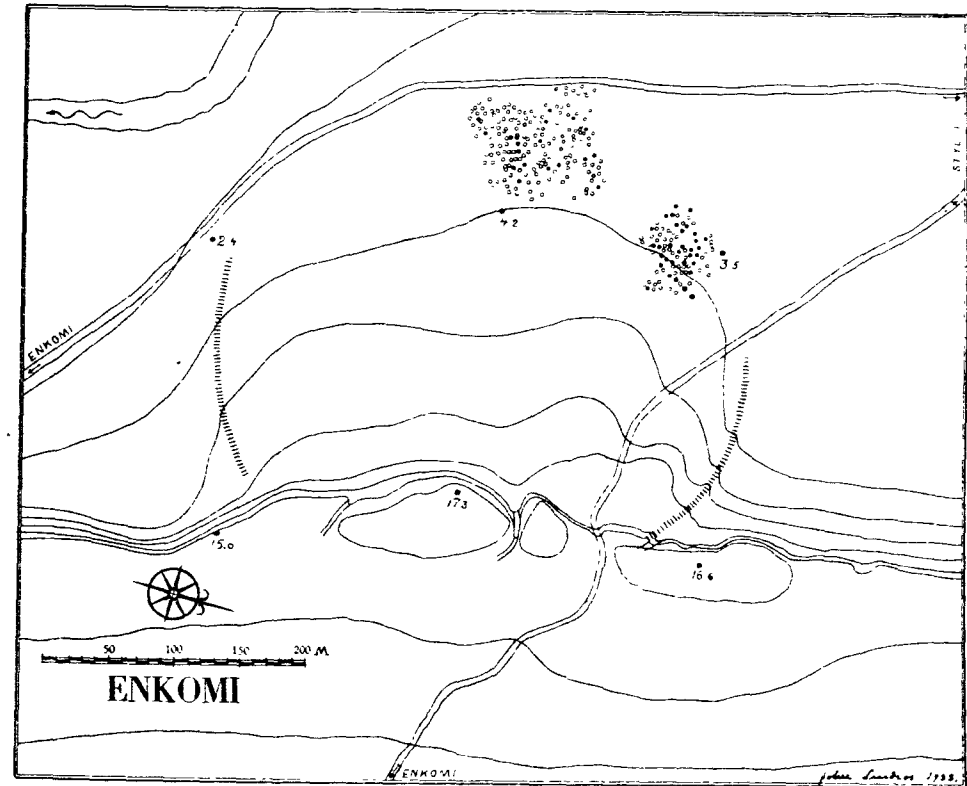

3

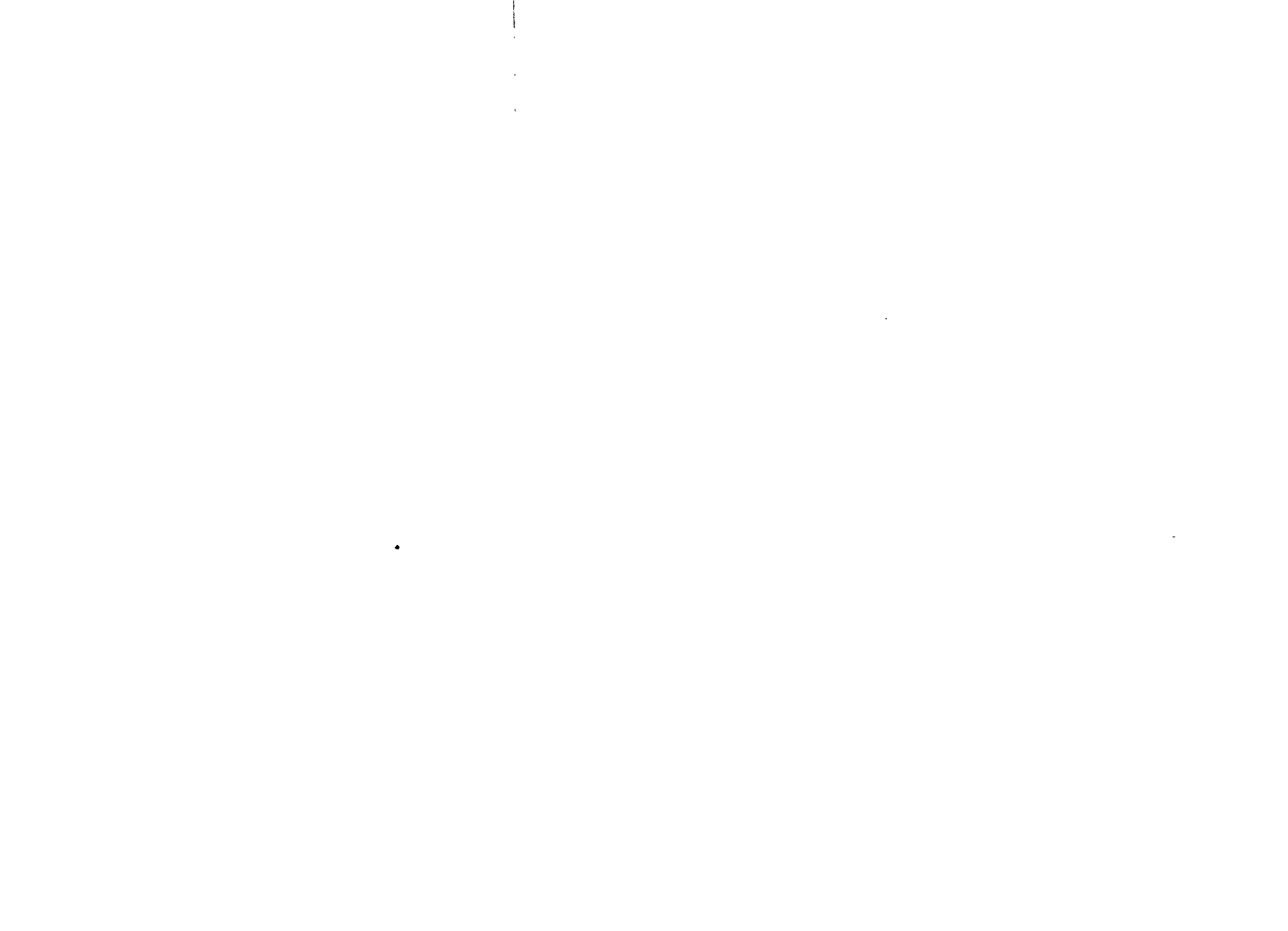

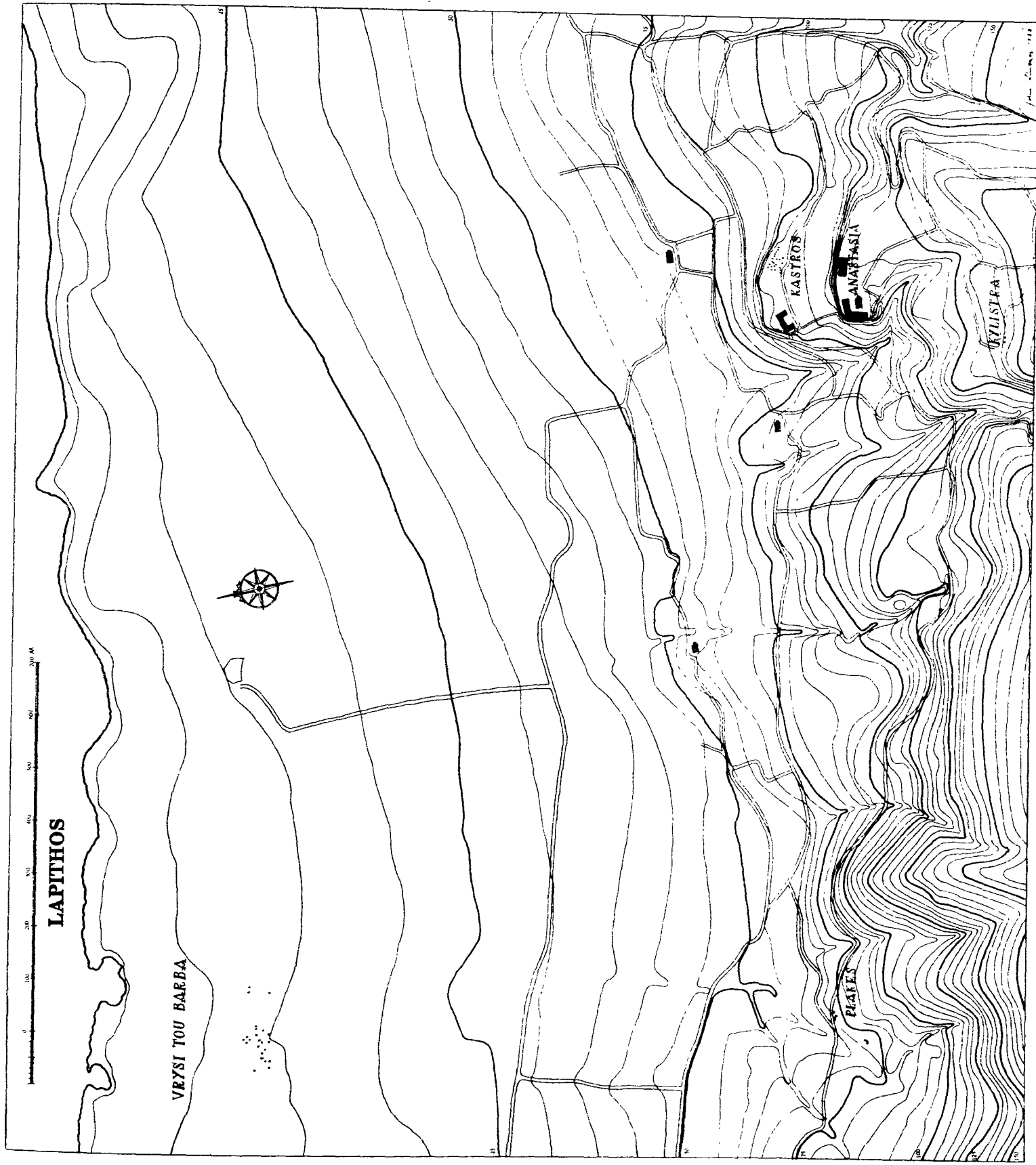

1

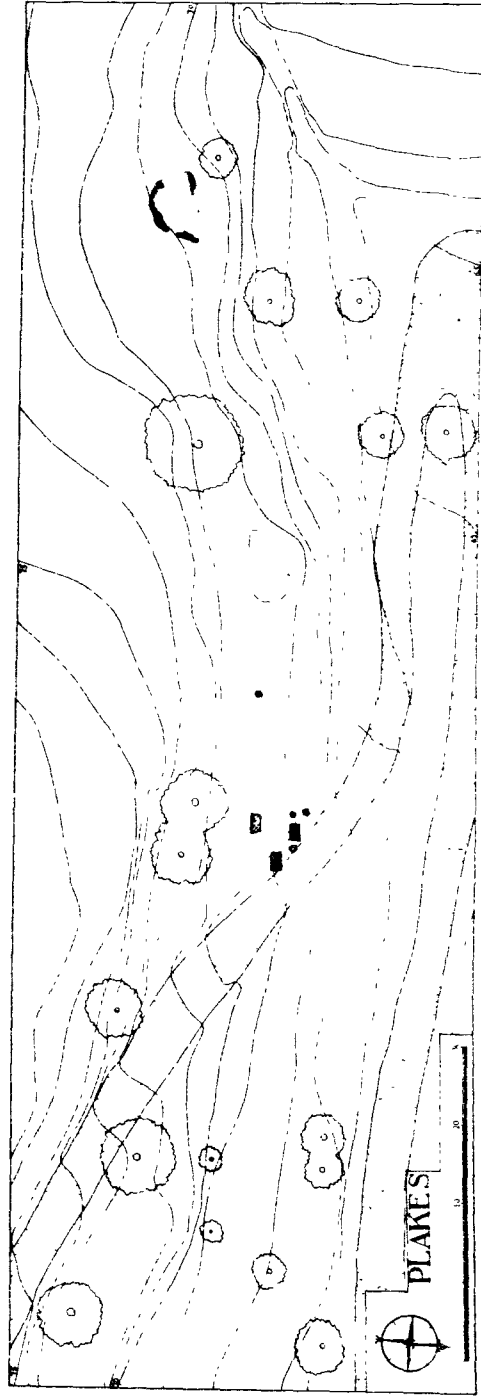

2

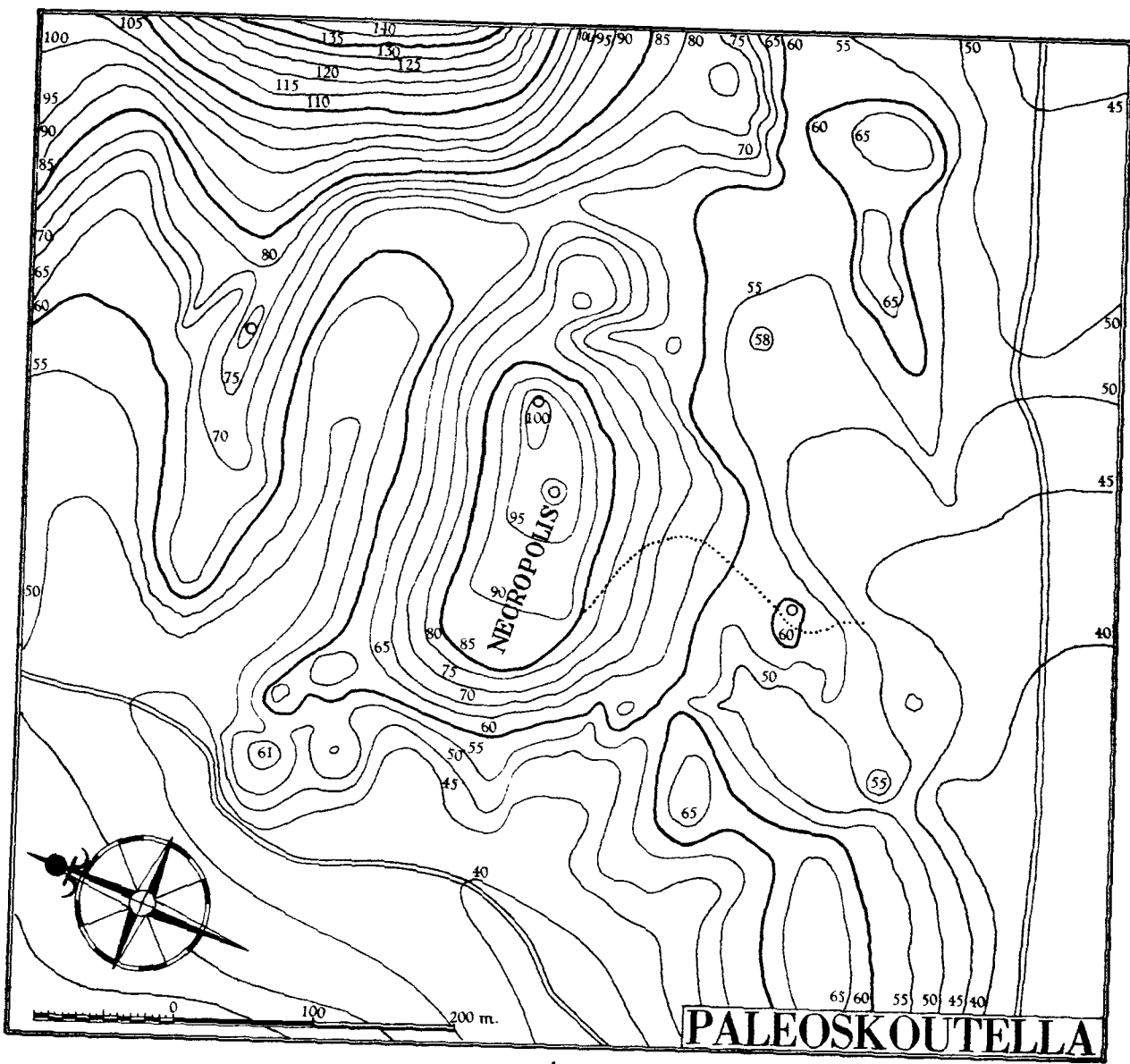

1

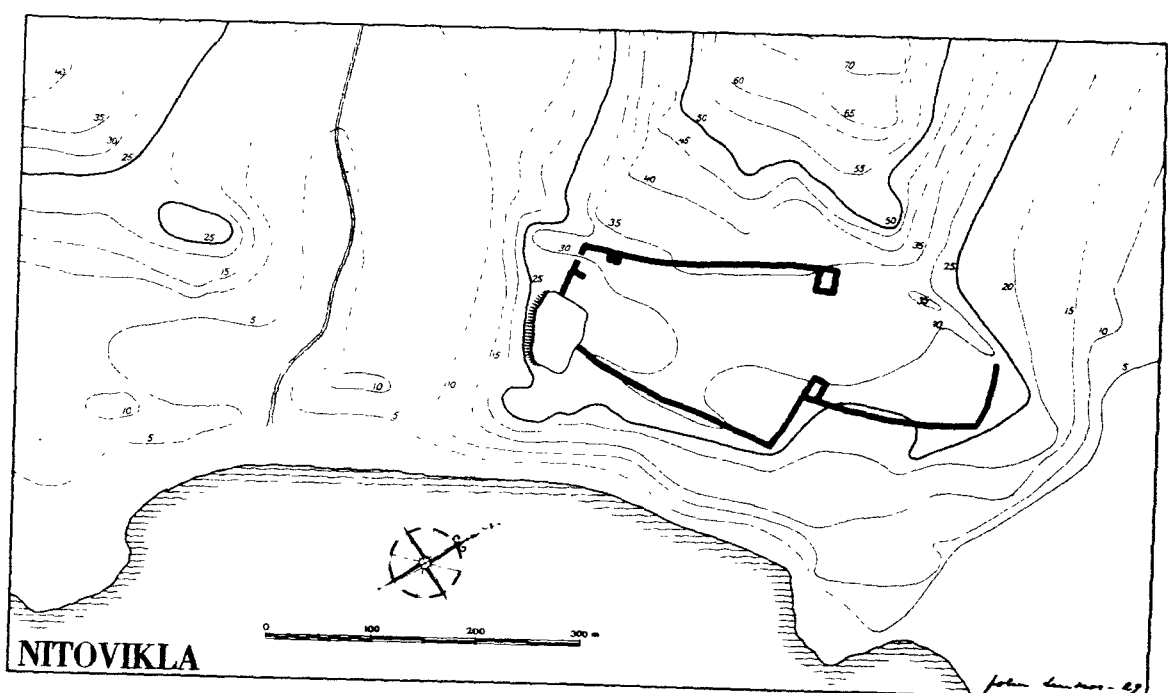

2

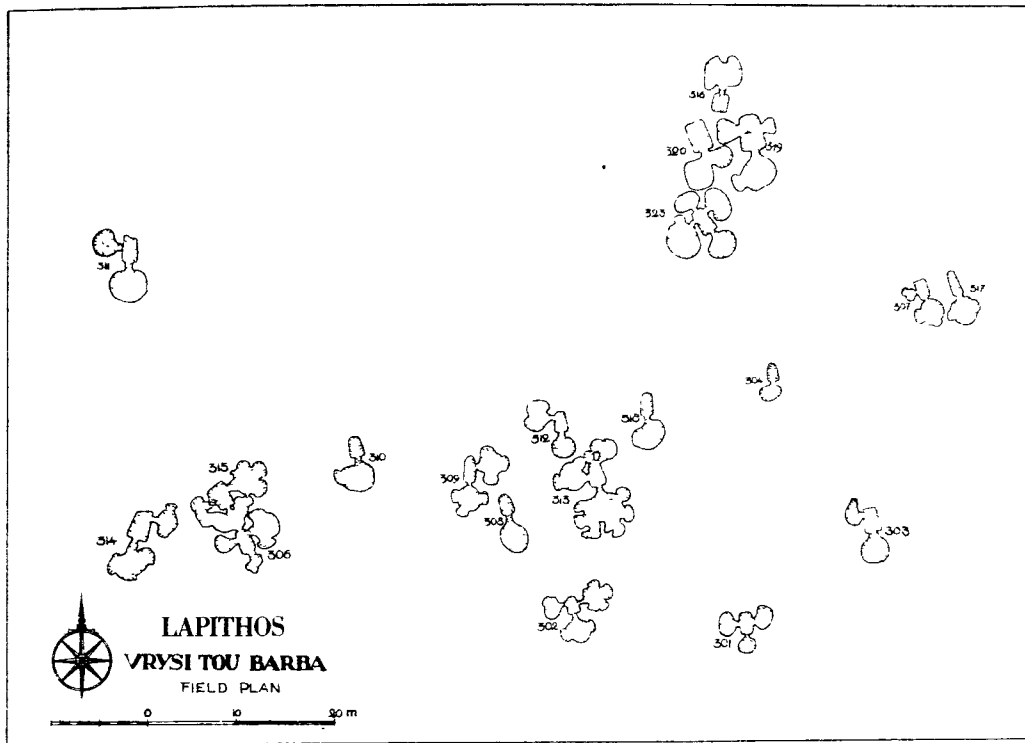

1

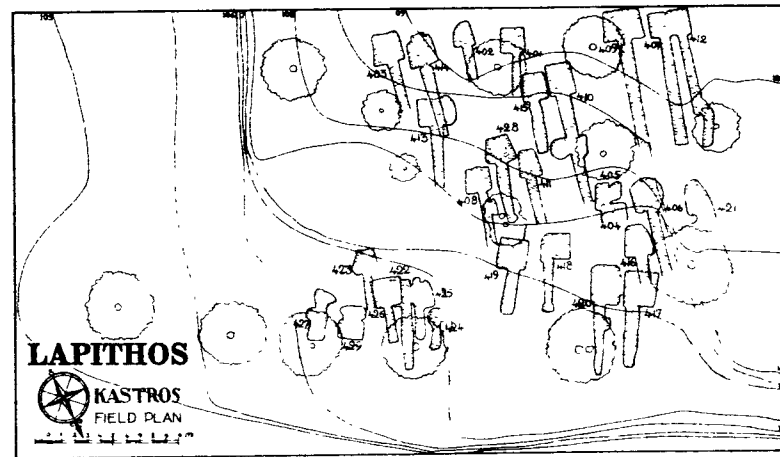

2

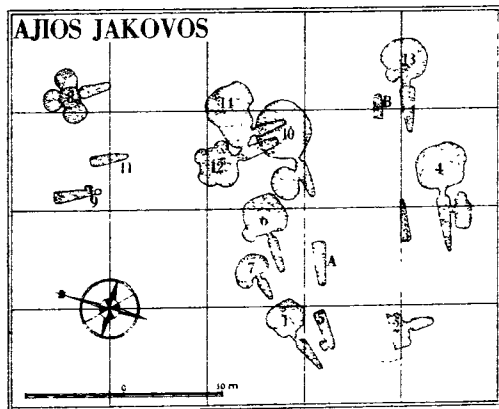

3

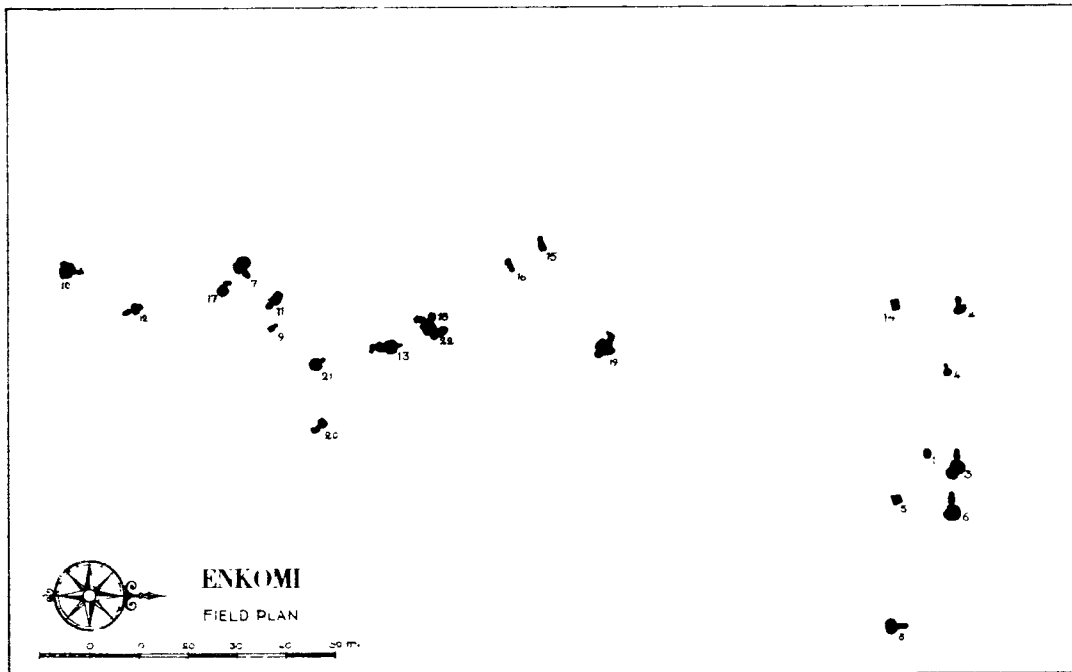

4

PETRA TOU LIMNITI

Pre-Neolithic settlement

TOPOGRAPHY (Plan II, 1)

Petra tou Limniti is a small rocky island off the north coast of Cyprus, between the bays of Chrysochou and Morfou, 6 km. west of Vouni and 12 km. from Soli and at a distance of 80 m. from the shore (Figs. 1, 2; Plan II, 1). The island is 150 m. in length, 105 m. in width and nearly 50 m. above sea-level, the highest point being 49.1 m. It is oval in shape: the north and west sides are very steep and almost vertical in places; the south side slopes steeply near the top, but more gradually further down; the east side is the easiest but even there the declivity is about 45° . In practice, this is the only side from which the top is accessible. On the top there is a small plateau, about 70 m. in length by about 25 m. in width, sloping slightly towards the East. The surface is rough and rocky except in the centre, where a small area, about 10 m. square, was found covered with earth; and within this area the excavation was carried out (Fig. 4). Several pieces of worked flint, stone implements, fragments of stone bowls etc. (see below p. 9) picked up on the surface, and the absence of potsherds of any kind, indicated that there were remains of a Stone Age settlement similar to that already discovered at the village of Frenaros¹. It is worth noting, that in spite of careful examination of the shore opposite Petra, not a single fragment of flint, or any other stone implement was found, so that it seems safe to conclude that the Stone Age settlement was confined to the island.



Fig. 1. Petra tou Limniti from the South-East.

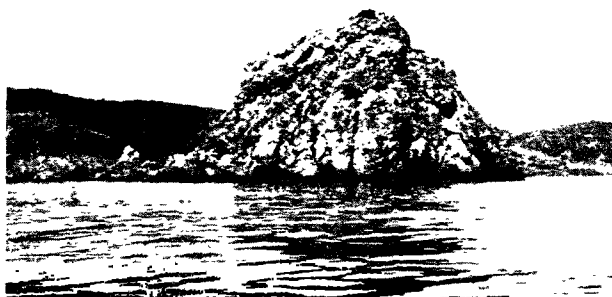

Fig. 2. Petra tou Limniti from the North-East.



Fig. 3. Petra tou Limniti. The excavated huts.

The area to be excavated was divided into squares, each square with a side of 1.50 m., called on the plan A, B, C, D, E, F 1—6. The stratification of each square was carefully studied; sections of every side of the squares were drawn and the earth was cleared according to lines of the natural strata. A study of the whole stratification of the place shows that it was inhabited during four periods, here called Petra I, II, III, IV.

ARCHITECTURE (Figs. 3—9; Plans VI, VII)

The remains of Petra I culture were found in association with a cavity in the rock in Squares C—F: 3—5 (Fig. 6; Plans VI; VII, 2). This cavity is natural and irregular in shape: the east side nearly straight, but the remainder are rounded. The maximum length is 4.80 m. the maximum width 3.45 m. The widest part is towards the North, and towards the South it narrows to a width of 1.30 m. only. The bottom of the cavity is not flat, but slopes towards the East and South: the fall is, however, only about 0.20 m. The depth

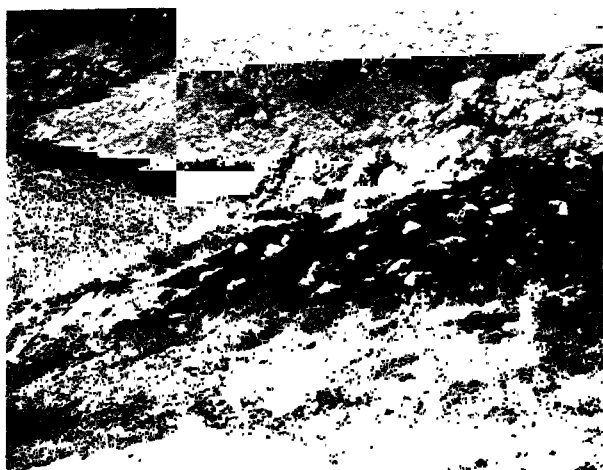

Fig. 4. Petra tou Limniti. The top plateau before excavation.

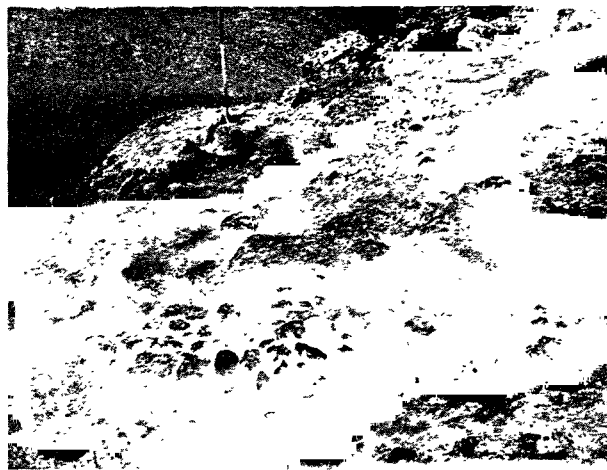

Fig. 5. Petra tou Limniti. The earth floor of Petra III.

of the cavity varies with the slope of the rock surface which also falls to the East and South: the west and north walls of the cavity are higher than those of the east and south sides.

This natural cavity was used for the construction of a primitive hut. All that remains of this are a group of rough stones embedded in gravel at the southern end of the cavity; a culture stratum of dark, somewhat sandy earth mixed with ash and carbonized matter, and above that a stratum of brown earth, mixed with streaks of ash and carbonized matter (Plans VI, 2, VII). The dark stratum rests directly on the rock in the north-west part of the cavity, but in the south-east part, there are two layers of natural rock gravel and dark-brown earth between it and the rock. These layers, formed of weathered rock and drifted earth, were there before the cavity was occupied by man and fill up the hollows in its shallower parts.

The extent of the hut is shown by the edge of the dark stratum: to the North and West it is limited by the rock wall of the cavity, to the South by the group of stones, and to the East by a line, which near the north rock wall runs approximately parallel with the eastern limit of the cavity, but at the south end is about 0.80—1.00 m. east of it. Most probably there was a stone foundation for the hut wall along the east side to replace the missing rock wall, but the stones have rolled down the steep slope.

How the walls of the hut were constructed is a question for conjecture, but by analogy with other primitive huts and the actual remains, it seems safe to conclude that the dark layer with ash and carbonized matter represents the remains of straw or brushwood that have been burnt; and the layer of brown earth represents the earth by which the straw or brushwood wall was made watertight. It is worth noting that clay was not used for covering the walls, which explains the fact that no impressions of the straw, or brushwood were found.

After the conflagration, a new hut belonging to Petra II period was built on the debris. The remains of this hut are shown by two successive strata, one dark and one brown of the same character and consistency as those of the earlier hut, and a single, large stone on the

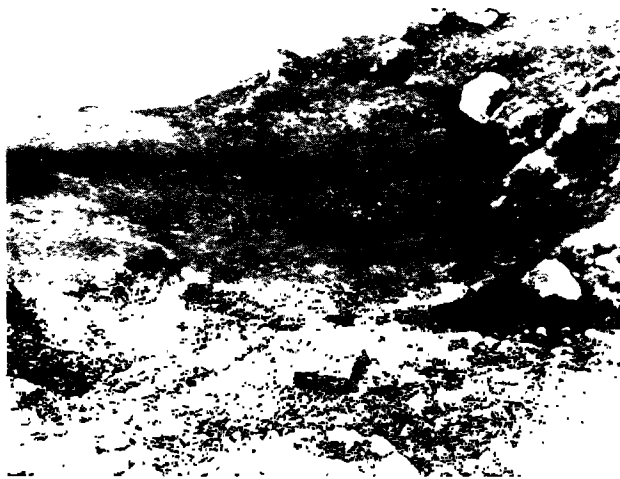

Fig. 6. Petra tou Limniti. The cave.



Fig. 7. Petra tou Limniti. The hearth.

edge of Squares D 4—5 (Plans VI, 1; VII, 2). The dark stratum extends partly within the area of the earlier hut, partly west of it in Squares C—E: 1—3, and to some extent also in Squares B 2—3 and F 1—2 (Plans VI, VII), which indicates the existence of two huts in this period, of a construction similar to that of the earlier hut. No built floor existed nor even stone foundations for the walls. The big stone in Squares D 4—5 was probably used as a base for a wooden post supporting the eastern hut. These two later huts were also burnt down and their destruction marks the end of Petra II, and the beginning of Petra III period.

The occupation of Petra III period is represented by the remains of a hut with two rooms: a living-room and a kitchen (Plan VI, 1). The living-room is situated to the East and the kitchen to the West. The living-room is fairly well preserved and its shape and construction are quite clear: it is oblong with straight sides and rounded corners, the average length being 4.50 m., and the average width 3.00 m. The foundations consist of a single set of unhewn stones. Most of the south-west and north walls are preserved, but the east wall has fallen down the steep slope together with the eastern end of the room. Of the preserved foundations, the north wall is most strongly built, with a course of stones, about 1.00 m. wide, embedded in a yellowish clay and rather higher on the outside. The lowest and innermost course of these stones are covered by the floor so that they are to be considered as a strengthening of the foundation and have not directly supported the upper wall. The floor consists of a compressed, rammed layer of mud, of the same consistency as that binding the foundation walls, but darker in colour through exposure to the dust and dirt of daily life. The outside entrance of the room seems to have been at the short, southern side. Here are two holes, lined with pebbles that were most probably holes for fixing the wooden door post (Figs. 8, 9). One of the holes is on the edge of Squares A 4—5 and the other in Square B 6: they are of like construction with medium-sized, oval pebbles lining an irregular hole, dug down to the rock. The stones were embedded in clay, brighter in colour than the earth that filled the holes; at the bottom of the hole in Squares A 4—5 there is a

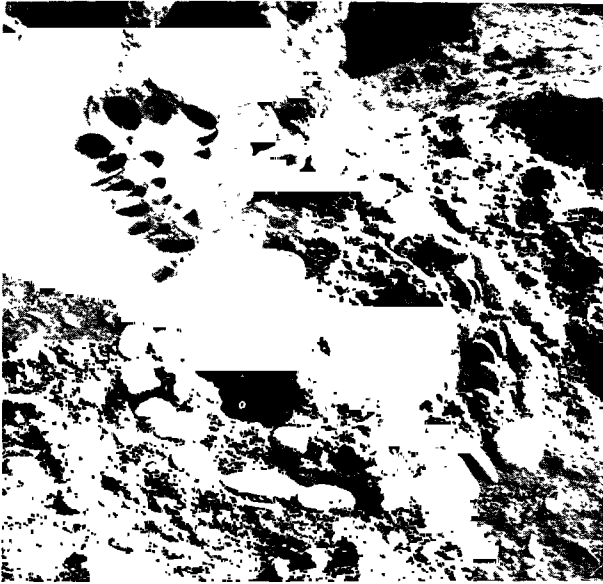

Fig. 8. Petra tou Limniti. Hole for fixing wooden door post.

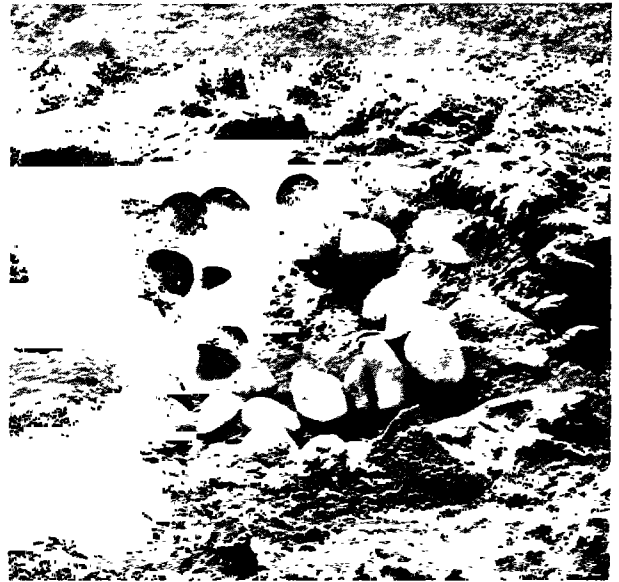

Fig. 9. Petra tou Limniti. Hole for fixing wooden door post.

round stone slab serving as a base for the wooden post. The depth of the holes show a difference of 0.60 m. on account of the sloping rock ground. It is interesting to note that the hole, in Square B 6, which is lower down the slope, is about twice as wide as the other and the lower post must have been 0.60 m. longer, if the tops of the posts were to be level, and therefore, for the sake of strength a thicker post was chosen.

The foundations of the kitchen are destroyed except for a short piece of the north wall. This is of the same construction as those of the living-room, and the stratification shows that the upper walls have also been built in the same way as those of the earlier huts (cf. above and Plan VI, 2). The floor is of the same construction as that of the living-room.

The shape of the kitchen seems to be similar to that of the living-room: i. e. straight-sided with rounded corners. All the walls are straight, except the south: part of the north wall is preserved, the line of the west wall is shown by a straight edge of rock, and the east wall forms the division between the two rooms. The line of the south wall only is vague, as the edge of the floor has been damaged.

The characteristic feature of the room is the hearth (Fig. 7), placed against the west wall of the room: it is built of large, unhewn stones placed in a circle, among which is a large block resting on the rock; this apparently was there from the beginning, since even the lower black layer of the Petra II hut abuts on it (Plan VI, 2). The bottom of the hearth, inside this edging of stones, is paved with flat stone slabs and big pebbles and was found with a very black layer of ash and carbonized matter, about 0.20 m. thick, upon it.

The living-room communicated with the kitchen by a door at the north-east corner of the latter. That there was once a door here, is shown by the fact that there are no remains of wall at this place, and no traces that there ever was one; on the contrary Section II

(Plan VI, 2) and the photo, Fig. 5, show that the floor of the kitchen joins that of the living-room, dropping by a step-like ledge, about 0.25 m. high, from the higher level of the former to the lower level of the latter.

The layers above the two rooms are different; the floor of the living-room has been repaired with a layer of small pebbles and gravel, and on that is a surface layer of grey-black earth; on the floor of the kitchen, on the other hand, there is a layer of brown earth, and above that a black, burnt layer similar to those of Petra I—II huts; above again there is again a layer of brown earth and above that another floor, of small pebbles and gravel; lastly, on this floor rests the surface layer of grey-black earth (Plan VI, 2). These layers show that the kitchen was destroyed by fire, on the debris of which a hut with a pebble floor was constructed; the living-room was not burnt and a new floor only of pebbles and gravel was laid on the old floor at the time of the construction of the new hut over the old kitchen.

The repaired living-room and the new hut are the architectural remains belonging the last period of occupation of Petra tou Limniti: called Petra IV period.

It seems natural to suppose that this new hut was intended to replace the burnt kitchen, but no traces, indicating that it was used as such were found. The surface layer, however, as shown in Sections I—II (Plan VI, 2), is very thin, so that the absence of traces of a hearth, or cooking place is of no great value as negative evidence.

The remains of the hut consist of a floor, as already mentioned, built of pebbles and gravel, and edged by a course of larger stones serving as a foundation for the upper wall. The shape of the hut is oval, but the position of the entrance cannot be made out with certainty.

To sum up the structural development: in Petra I period, a primitive hut was built of straw or brushwood, packed with earth, around a natural cavity in the rock, which formed the lower part of the hut; in Petra II period, there were two huts of the same type, but the cavity, being now full of debris, could not be used as part of the hut; in Petra III period, we find a larger hut, consisting of two rooms, an outer living-room and an inner kitchen; the walls of the huts were straight, with rounded corners, and were of similar construction to the earlier huts but were raised on a course of stones; two wooden posts flanked the door of the living-room and a floor of rammed earth was laid in the rooms; Petra IV period is represented, first by the construction of an oval hut, replacing the burnt kitchen, with a floor of pebbles and gravel, and an edging course of stones as a foundation for the upper walls, and also by the repairs to the old living-room in which a new floor of gravel and pebbles was laid; in Petra IV period, consequently, the old living-room was an isolated hut beside the newly-built oval hut.

There is, consequently, an architectural development to be observed from the cave-hut of Petra I and the huts without stone foundations of Petra II to those of Petra III with a stone foundation and an earth floor, and those of Petra IV with a pebble floor. Still, there cannot have elapsed a long time between the earliest and the latest huts. Since the oval hut of Petra III was used in Petra IV period too, no longer time can have elapsed between the beginning of Petra III and the end of Petra IV than the maximum time which a hut built of such a perishable material may last, i. e. hardly more than 10 years. It is therefore

evident that the periods I—IV are only periods of habitation and do not represent different chronological epochs. The whole time of habitation may have been only 40—50 years.

Since the destruction of these last huts, the island has never been occupied. A very interesting observation was made during the excavations, which may assist us to understand why this island was chosen as a place of habitation, and for what reason it was abandoned: it was observed that whatever storms raged round this small and much exposed island, there was always an absolutely sheltered spot within the excavated area, especially down in the cavity, when it was often difficult to stand upright on the top of the rock. It seems therefore probable that the isolated and protected situation of the island, very favourable from the point of view of defence, combined with the above circumstances persuaded the first inhabitants to build their hut there. But the more the debris from the destroyed huts accumulated, the less sheltered the place became; and when, after the destruction of the last huts, the accumulation of earth had reached the high windy level, the place was abandoned.

FINDS (Pls. V—VIII, XCIII: 1—4, 17)

OBJECT REGISTER

1. Plate of mortar of dolerite; circular, thick; with flat bottom; rounded, raised rim and six vertical ribs projecting around the sides. Chipped. Diam. 12.0. Stray find.
2. Axe-head of basalt, boat-shaped; narrow, thin, slightly wider at the edge; edge sharp and curved; polished; upper part missing. Length 3.4. Stray find.
3. Bead of greenish-blue steatite, cut from a single stone in the form of two spindle-shaped beads with ring-shaped joint between. Length 3.5. B 6.* 69.9.**
4. Whetstone, with wedge-shaped incisions; used for sharpening bone instruments; of limestone. Length 5.5. D 5. Stray find.
5. Leaf-shaped knife of light-brown flint; one side flat, the other with midrib; single, roughly retouched cutting edge; curved point and straight top. Length 6.5. D 5. 64.5.
6. Cockle-shaped scraper of light-brown flint, with curved, roughly retouched edge. Length 5.6. E 5. 65.3.
7. Splinter (knife?) of buff-brown flint with light-blue streaks; one side flat, the other with high midrib; single cutting edge; pointed end (broken); cuttings at top for fixing into a handle (?). Length 7.0. F 5. 70.4.
8. Sinker of dolerite, circular with elliptical section; a bored hole through the middle, pierced from both sides. Diam. 8.0. F 5. 67.5.
9. Fragment of knife of light-brown flint; one side flat, the other with midrib; double cutting edge. Length 3.4. C 5. 64.3.
10. Grinder of dolerite, oval with semicircular section. Length 30.0. C 5. 73.0—71.5.
11. Scraper of bluish-white flint with light-blue spots; roughly triangular in shape; with single, curved edge; surface roughly worked. Length 5.5. B 4. 75.6.
12. Bowl-mortar of dolerite, oval in shape, with flattened bottom. Length 10.0—8.0. A 2. 73.3.
13. a) Small knife or scraper of bluish-white flint; single, roughly retouched, curved edge. Length 3.9. B 4. 79.0.
b) Leaf-shaped knife of whitish-buff flint; one side flat, the other with midrib; double cutting edge, and pointed end; upper end broken. Length 4.0. B 4. 76.0.
14. Chisel of white flint, rather roughly cut in wide flakes, with thin, curved edge, widening slightly towards the top; upper part broken off. Length 7.4. B 1. 83.7.
15. Fragment of knife of light-brown flint; one side flat the other with flat, rounded top, and double cutting edge. Length 1.8. C 1. 86.0.
16. Bone awl, leaf-shaped, rather flat; with pointed end and midrib. Length 3.8. C 1. 85.8.
17. Fragment of bone pin with pointed end; upper part missing. Length 3.3. C 1. 86.0.
18. Fragment of knife of light-brown flint; one side flat, the other with midrib; double cutting edge; only upper end preserved. Length 3.2. B 1. Stray find.
19. Scraper of red flint; broad, with narrow top and pointed end; probably used as scraper. Length 7.2. C 1. 83.9.
20. Awl of bluish-white, brown-grained flint; flat on one side and roughly rounded by small chippings on the other; somewhat curved point. Length 2.9. B 3. 73.9.
21. Leaf-shaped knife of greenish-buff flint; one side flat, the other with midrib; double cutting edge, roughly retouched edges; end and top missing. Length 3.1. C 4. 75.6.
22. Leaf-shaped, thin knife of light-brown flint with red-brown parts; one side flat, the other with midrib, single cutting edge, pointed end and curved, narrow top for fixing into a handle; point broken off. Length 5.5. C 1. 83.5.
23. Axe-head of basalt, oval in section; with narrow, rounded top, convex sides; narrow end; curved and polished cutting edge. Length 11.5. D 1. 80.0.

* Square.

** Level.

24. Grinder of dolerite as No. 10; one end broken off. Length 31.0. F 3. 78.3.
25. Pendant of greyish-white Cypriote marble, conical in shape, with knob broken off. Length 3.0. F 2. 82.0.
26. Miniature axe-head of epidotized basalt, spindle-shaped, oval in section, curved cutting edge; polished surface. Length 3.0. C 1. 86.5.
27. Idol of dolerite, with fiddle-shaped body, broad neck, and rounded head with pointed chin, nose and eyebrows in relief; the whole covered with a layer of lime-concrete. Length 17.5. C 1. 84.9.
28. Spindle-whirl of limestone, roughly cylindrical, with a hole pierced from both sides. Diam. 4.5. C 2. 77.5.
29. Fragment of axe-head of basalt, flattened, with curved cutting edge; upper part missing. Length 4.2. D 1. 84.0.
30. Fragment of a knife of blackish-grey obsidian, nearly transparent; thin, with two cutting edges and flat, narrow top; broken at both ends. Length 2.7. E 4. Stray find.
31. Leaf-shaped knife of white flint; one side flat, the other with midrib at the upper end, and flat top at the lower end; narrower at the upper end for fixing into a handle; single cutting edge. Length 5.4. D 4. 64.0.
32. Splinter of white flint (knife?); narrow; one side flat, the other with high midrib. Length 5.4. D 4. 63.0.
33. Fragment of leaf-shaped knife of greenish-buff flint; one side flat, the other with midrib; double cutting edge. Length 4.5. E 3. Stray find.
34. Chisel of buff-brown flint with bluish-white streaks; trapezoid in shape; curved, retouched cutting edge. Length 3.3. C 3. On earth floor.
35. Awl of bone with pointed end; one convex and one concave side; upper part broken off. Length 7.0. C 3. On earth floor.
36. Awl of bone, with pointed end; broken at top. Length 5.5. C 1. On earth floor.
37. Fragment of bone pin with pointed end, slightly curved; upper part missing. Length 4.4. C 1. On earth floor.
38. a) Bone needle with pointed end.
b) Fragment of bone needle.
c) Point of needle of burnt bone. C 1. On earth floor.
39. Small splinters of various kinds of the usual kinds of flint. B 2—C 2. Below earth floor.
40. Leaf-shaped knife of grey, gritty, mat flint; one side flat, the other with midrib; narrow upper part with rounded, chipped top for fixing it into a handle; lower part missing. Length 4.5. C 3. 74.0.
41. Awl of Cypriote marble, greyish-white in colour, with pointed end, and chipped off at the top. Length 3.6. C 3. 72.5.
42. Idol of dolerite, nearly rectangular with curved ends, the arms marked by projecting stumps, and the mouth by a hollow. Length 15.0. C 3. On earth floor.
43. Fragment of round, shallow bowl of quartz-dolerite with flat bottom, slightly convex side and plain rim; notched relief band around the side. Height 6.8. C 3. Below upper floor.
44. Fragment of round, shallow bowl of limestone with flat bottom, thick, bulging side, and plain rim, bending inwards. Height 7.5. C 3. Below upper floor.
45. Fragment of bowl-mortar of dolerite, deep and round, with thick wall and rim bent inwards. Diam about 19.0. B 4. Below earth floor.
46. Leaf-shaped, broad knife of whitish-buff flint; one side flat, the other with lateral rib; single cutting edge, chip-pings at the top for fixing it into a handle; end broken off. Length 10.1. B 4. Below earth floor.
47. Trapezoid plate of limestone, with rounded bottom, and slightly raised rim; one corner missing. Length 12.7. C 4. Below pebble floor.
48. Handle of elk's or fallowdeer's horn with hole pierced at one end for insertion of an instrument. Length 8.5. B 3. On earth floor.
49. Globular bead of limestone. Diam. 2.7. B 3. On earth floor.
50. Fragment of basalt plate, with thick, flat bottom and low, upright rim, running into a vertical ledge-handle. Height 5.3. B 1—C 2. Below earth floor.
51. Axe-head of basalt; boat-shaped; elliptical in section and of uniform thickness; narrow, rounded top; curved cutting edge; polished. Length 14.4. C 4. Below earth floor.
52. Grindstone of basalt; circular, with flat bottom and top. Diam. 9.5. B 2—C 2. Below earth floor.
53. Shell of pectunculus. D 5. Lower cave-stratum.
54. Fragment of limestone bowl; circular, shallow, with flat base and rim curving inwards. Length 6.5. D 5. Lower cave-stratum.
55. Fragments of basalt bowl; deep, with flat bottom; upright, slightly convex side and plain rim. B 4—B 5. In and below upper floor.
56. a) Axe-head of quartz-basalt; flat, of uniform thickness, with almost straight sides and slightly curved cutting edge, not yet finished; upper part missing. Length 10.0. B 4—B 5. In and below upper floor.
b) Fragment of axe-head of quartz-basalt; boat-shaped. Length 8.3. B 4—B 5. In and below upper floor.
57. Fragment of limestone plate; circular, very shallow, with flat bottom and plain rim. Length 9.0. B 4—B 5. In and below upper floor.
58. Fragment of limestone bowl; circular, deep, with flat bottom, convex side, vertical ledge-handle, and bent-in rim (missing). Height (of fragment) 7.7. E 3. Surface stratum.
59. Fragment of limestone bowl, as No. 54. Height 4.5. C 5. Lower cave-stratum.
60. Fragment of roundish axe-head of dolerite; oval in section, narrowed towards the curved top; lower part missing. Length 7.7. C 5. Lower cave-stratum.
61. Fragment of dolerite bowl; circular, shallow with thick, flat bottom; thick, convex side and plain rim. Height 9.5. C 5. Lower cave-stratum.
62. Fragment of limestone bowl; circular, deep, with flat bottom, convex side and plain rim. Height 9.0. E 3. Below earth floor.
63. Fragment of limestone bowl, as No. 44. Height 9.3. E 3. Above pebble floor.

64. a) Fragment of limestone bowl, as No. 44 and 63, but shallower. Height 6.0. B 3. Below earth floor.
 b) Fragment of limestone bowl, as No. 54. Height 5.0. B 3. Below floor.
65. Whetstone, nearly rectangular, with slightly convex sides and worn, concave surface; of limestone. Length 10.3. Surface stratum.
66. a) Fragment of limestone bowl, as No 54. Height 5.0. Surface stratum.
 b) Fragment of limestone bowl, similar to preceding, but without bent-in rim. Height c. 5.0. Surface stratum.
 c) Fragment of limestone bowl, as No. 44, with tripodic projections from bottom (one projection preserved). Height c. 8.0. Surface stratum.
67. a) Fragment of quartz-dolerite bowl, as No. 54. Height 6.5. Surface stratum.
 b) Fragment of dolerite bowl, as No. 66 b. Height c. 5.0. Surface stratum.
 c) Fragment of quartz-basalt plate; circular, very shallow, with flat bottom and a rounded ring-rim. Height. 1.5. Surface stratum.
68. Hammer-stone of dolerite-basalt; flat, with curved end and slightly contracted in the middle; half missing. Length 7.5. Surface stratum.
69. Fragment of dolerite pestle, conical; lower part missing. Length 5.3. Surface stratum.
70. a--b) Two fragments of grinder of dolerite, oval with semicircular section. Length 18.5 (a). 15.0 (b). Surface stratum.
71. Hammer-stone of amygdaloidal basalt; flat, cockle-shaped, with opposite notches at the middle of the edge. Length 10.5. Surface stratum.
72. Idol of dolerite, similar to No. 42; the arms marked by projecting stumps, the mouth by a hollow, and the legs by a triangular division of the lower end; head missing. Length 15.0. C 1. On earth floor.
73. Fragment of small limestone bowl as No. 54. Height 2.6. C 4. Below earth floor.

Besides the numbered objects, numerous fragments of animal bones, flint chips, fragments of stone implements, and bowls of dolerite and limestone so tiny that the shape could not be ascertained, were found in the successive culture strata.

Bones of swine, sheep and cattle, teeth of sheep and fish-bones could be identified among the mass of animal bones collected.

CLASSIFICATION

The finds may be classified in three main groups: objects of flint, stone, and bone.

The flint is of different kinds: red, brown or brownish buff, greenish buff, bluish white, grey, and white or whitish buff in colour. The white variety is rather soft and mat. The grey variety is less soft and mat and the other kinds are hard and lustrous.

The flint objects consist of splinters, scrapers, knives, chisels, and awls. The scrapers (Nos. 6, 11, 19) are of irregular shape, roughly triangular or cockle-shaped; occasionally with the edge roughly retouched. The knives are leaf-shaped, with midrib, seldom flat, rounded top (No. 15), or with lateral rib (No. 46). Rough retouchings from one side only occur rarely. Some of the knives have cuttings for fixing the knife into a wooden handle. The chisels have a curved, sometimes retouched edge (No. 34). The type of awl represented is curved, with one side flat and the other roughly retouched. Besides the flints, there was found a single specimen of obsidian: a thin knife (No. 30) of blackish-grey obsidian, nearly transparent, with two cutting edges and a flat top.

The stone objects consist of chisels, axe-heads, whetstones, hammer-stones, sinkers, spindle-whirls, awls, bowls, plates, grindstones, pestles, beads, and idols.

The axe-heads are usually made of basalt or, occasionally, of dolerite and are of three types: the boat-shaped, the flat, and the roundish axes. The boat-shaped axes (Nos. 2, 51, 56b) are rather flat and have a narrow top; the flat axes represented (Nos. 29, 56a) are thicker, have almost straight sides and curved cutting edge; the roundish axes (Nos.

23, 60) have thick, narrow top and narrow, curved cutting edge. The miniature axe-head (No. 26) seems to have been a child's tool.

The whetstones are made of limestone and are of two types: whetstones with wedge-shaped incision for sharpening the points and edges of the bone implements (No. 4), and whetstones with slightly concave surface for stropping (No. 65).

The hammer-stones (Nos. 68, 71) are almost unworked stones of dolerite-basalt or amygdaloidal basalt.

The sinker (No. 8) represented is of dolerite, of circular shape, with a bored hole through the middle, the spindle-whirl (No. 28) is of limestone, roughly cylindrical in shape with a pierced hole through the longitudinal axis, the awl (No. 41) is of greyish-white marble, with pointed end.

The bowls and plates are either of dolerite or limestone. The finer specimens are carefully polished, but the surface of the large bowls is usually left unpolished and displays traces of the stone chisels used for cutting. The dolerite bowls are oval in shape, with flattened bottom (No. 12); round, shallow with flat bottom, slightly convex thin walls and plain rim (No. 43); round, deep, with thick walls and rim bent inwards (No. 45); round, deep, with flat bottom, upright, slightly convex thin walls and plain rim (No. 55); round, shallow with thick, flat bottom, thick, convex walls, and plain rim (No. 61); circular, shallow with flat base and plain rim (No. 67 b), or rim curving inwards (No. 67 a). The plates are circular, with flat bottom, and rounded, raised rim (No. 1); circular, with flat bottom and upright rim with a vertical ledge-handle (No. 50); circular, very shallow, with flat bottom and rounded ring-rim (No. 67 c). The bowl No. 43 is decorated with a notched relief band, and the plate No. 1 has vertical ribs around the sides.

The shapes of the limestone bowls (Nos. 44, 54, 58, 59, 62, 63, 64, 66, 73) are similar to those of the dolerite bowls. Of the plates (Nos. 47, 57), No. 47 is of a peculiar shape, trapezoidal with rounded bottom and slightly raised rim. The bowls are sometimes provided with tripods (No. 66 c) and ledge-handle (No. 58).

The grindstones (Nos. 10, 24, 70 a—b) are oblong, semicircular in section, with rounded base and flat top. The grinder (No. 52) is circular, with flat base and flattened upper side. The pestles (No. 69) are conical in shape. The stone used is dolerite.

The beads are made of limestone and globular in shape (No. 49); of marble and conical in shape (No. 25); or of steatite, consisting of two united double-conical beads (No. 3).

The idols are three in number (Nos. 27, 42, 72) and represent three successive stages of development of the same type: the fiddle-shaped idol. The less advanced type is No. 42, which is nearly rectangular in shape with curved top and base, projecting stumps marking the arms and a hollow for the mouth. No. 72 is similar to No. 42 but the legs are indicated by a triangular division of the lower end. The idol No. 42 represents the most advanced type, with rounded head, pointed chin, nose and eyebrows in relief. The idols are made of dolerite. The idol No. 27 is washed with a lime-concrete.

The bone objects consist of awls (Nos. 16, 35, 36), pins (Nos. 17, 37), needles (Nos. 38 a—c), and a handle of elk's horn (No. 48).

ABSOLUTE CHRONOLOGY

An absolute date for the culture of Petra as shown in the chronological studies of this work (Part IV) cannot be given. The absence of any fragment of pottery, the exclusive use of stone vases, the number of unpolished stone implements and unretouched flints show that the culture belongs to the Pre-Neolithic period, the date of which can only be fixed as preceding that of the Neolithic period.

E. G.

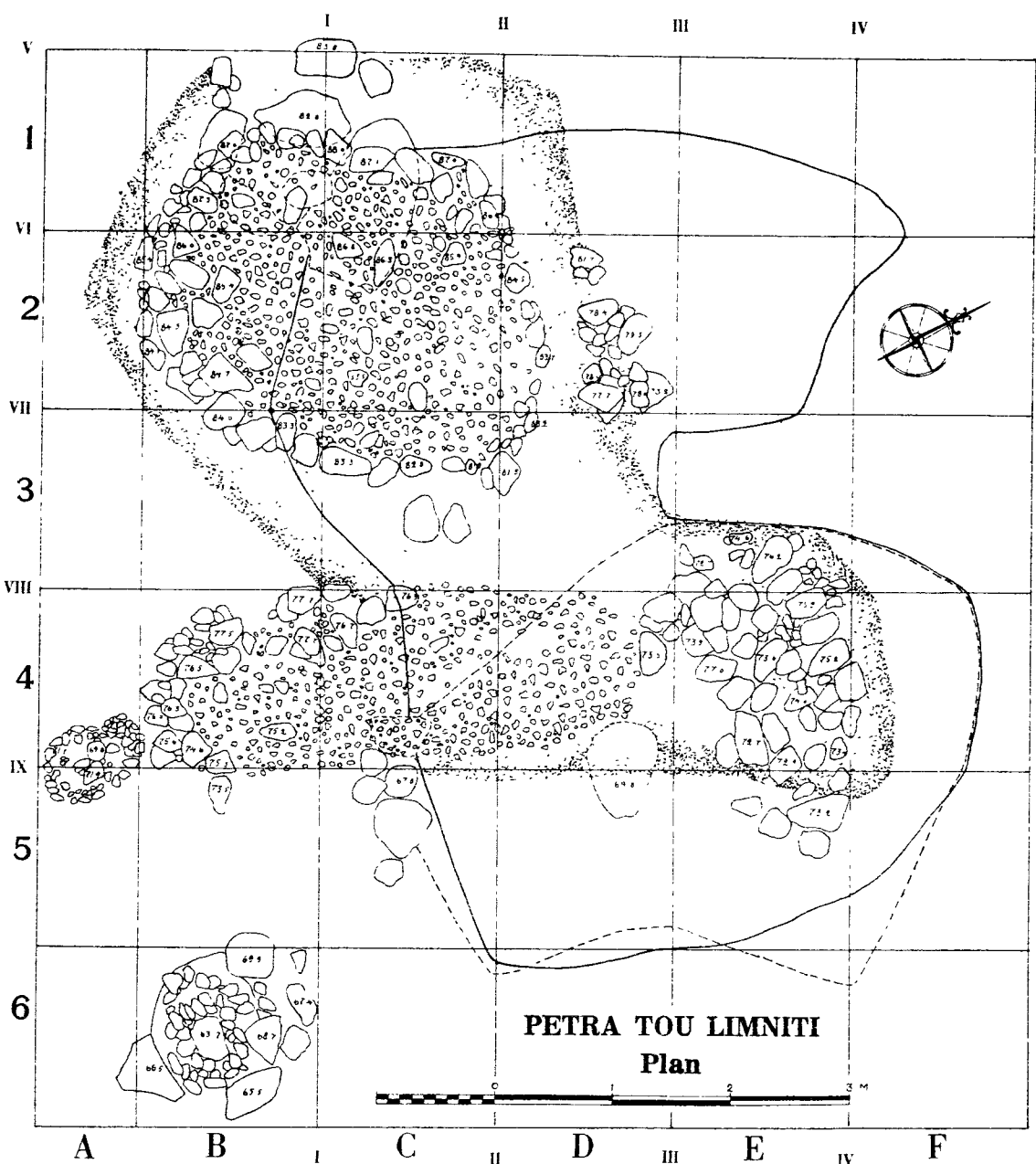

1

Sections

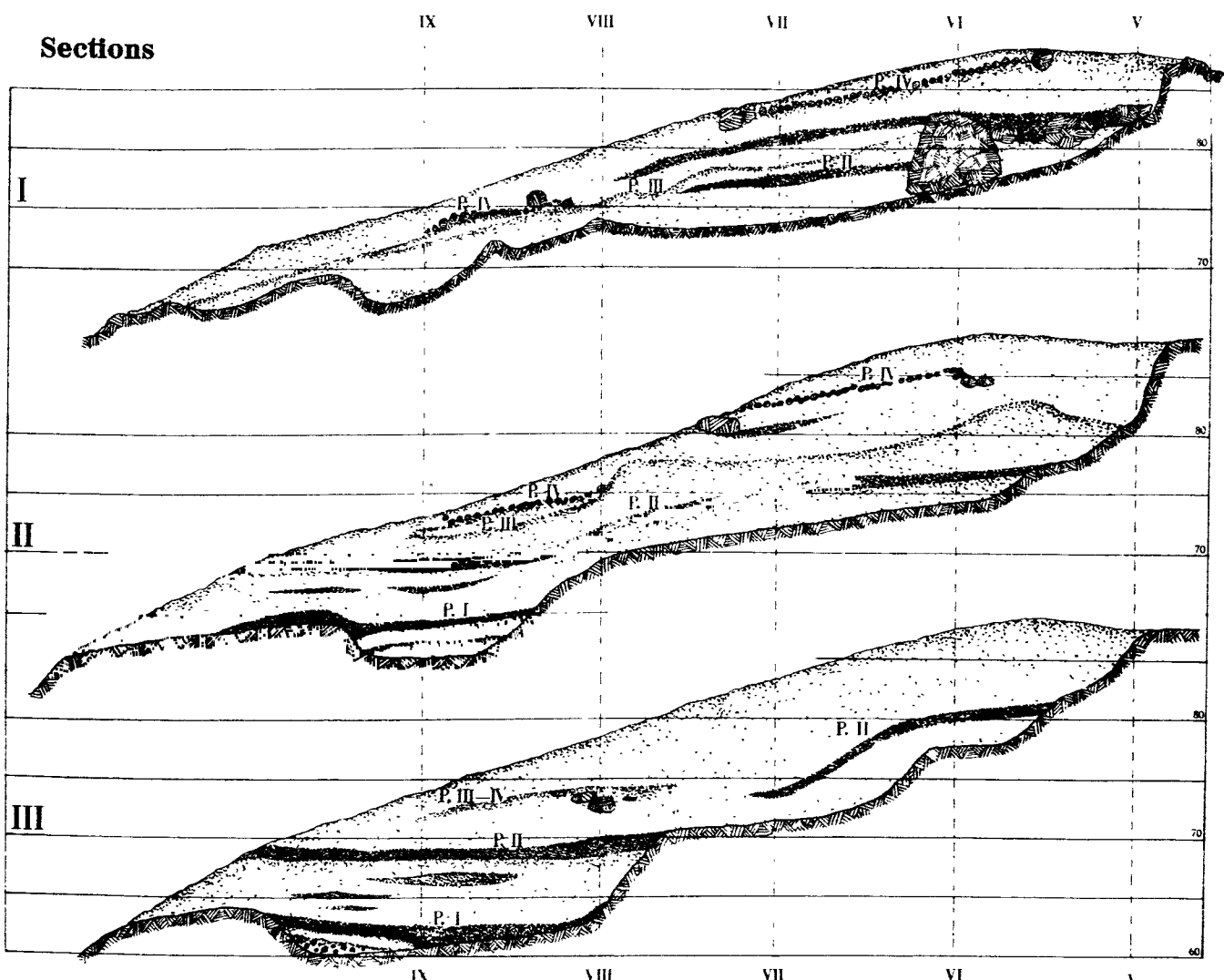

2

PETRA TOU LIMNITI

Sections

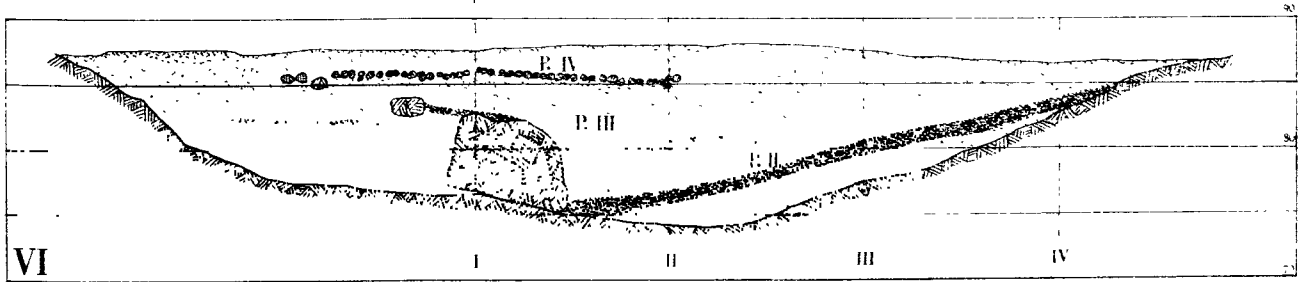
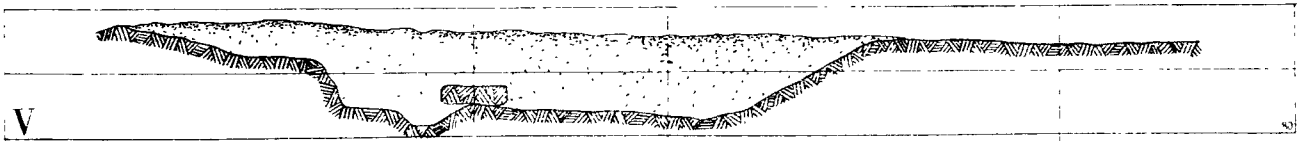
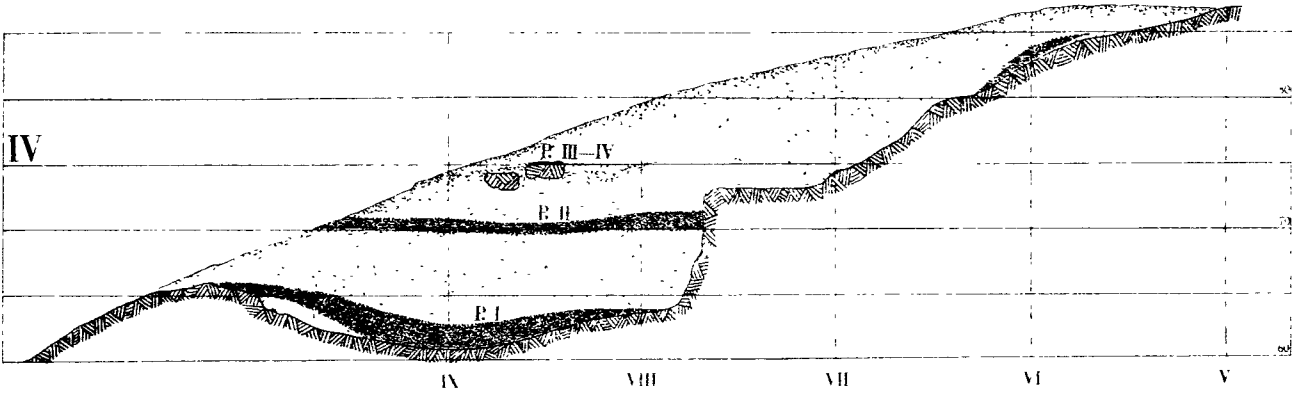

1

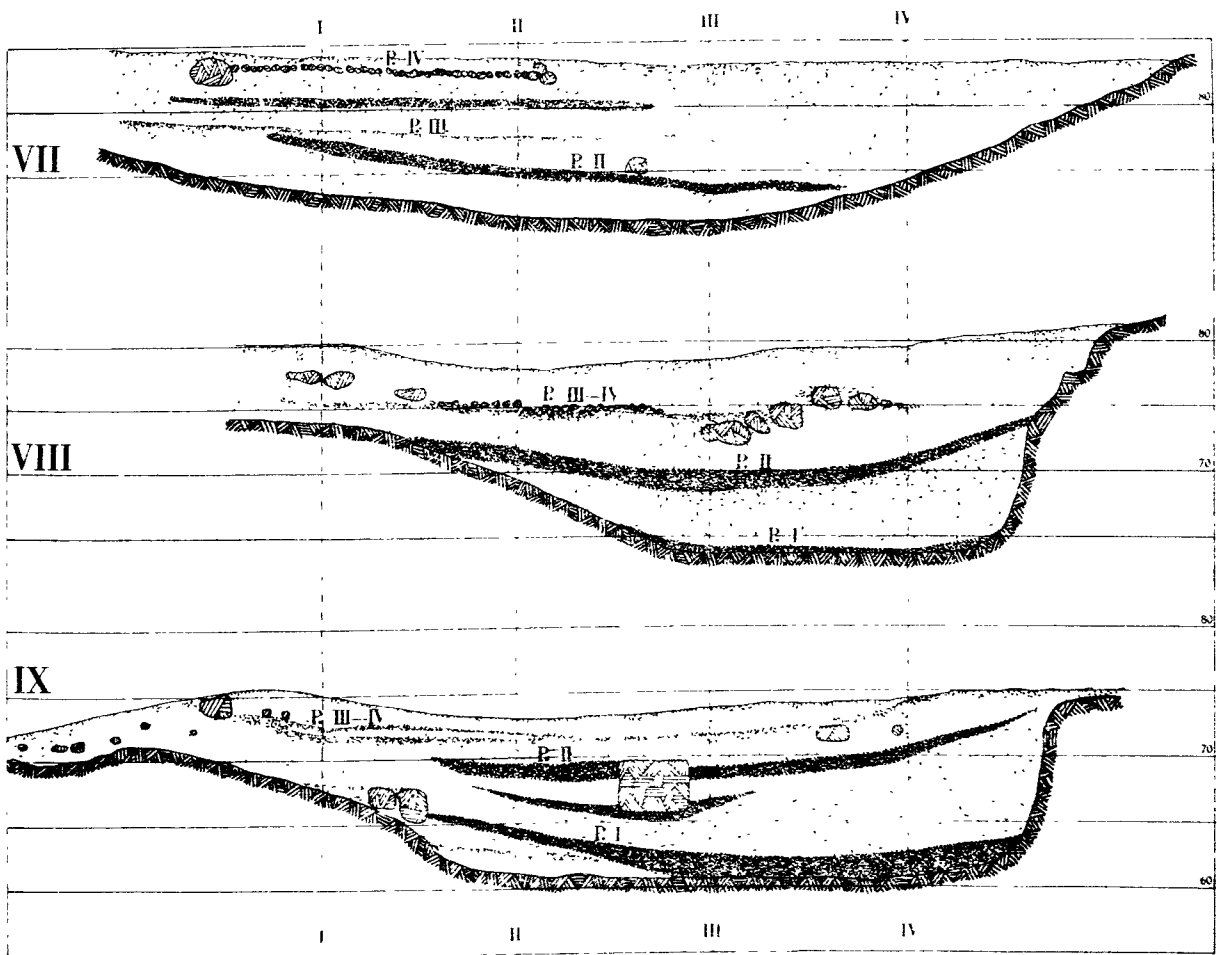

2

L A P I T H O S

Neolithic settlement

TOPOGRAPHY (Figs. 10, 11; Plan III)

The Neolithic settlement found by us in Lapithos, at the locality called Alonia ton Plakon (*Ἀλώνια τῶν Πλάκων*), is situated to the West of the village; it stands on the cultivated hillside at the foot of the Kerynia range near the point where the so-called old way to Vasilia and the track to Ajia Paraskevi meet, as shown by the field-plan (Plan III, 2).

The boundaries of the settlement are difficult to define as the place has been much damaged, both by human and by natural causes (see below pp. 16 ff.). In consequence, the boundaries of the settlement cannot be drawn with absolute certainty of detail. Based on the results of the excavation, and on examination of the surface, the following remarks can be made about the extent of the settlement. As shown by the plan (Plan III, 2) excavations were carried out on two different sites; one to the West (called the western settlement) and one to the East (called the eastern settlement). Trial pits sunk in the fields east of the road to Ajia Paraskevi, and potsherds from the sections of cuttings for the road, prove that remains of a settlement of the same date and character as the eastern settlement are found about 100 m. to the East as far as the valley of the river Vathis Potamos. Other trial pits sunk in the field between the eastern and western settlements prove that the eastern settlement petered out there. To the West of the western settlement the Neolithic remains come to a natural end at the valley of the river Potamos tis Arkomandra. There are no traces of Neolithic remains north of the road from Lapithos to Vasilia, which at this point follows the foot of the hills along the border of the site. How far up the hillside the Neolithic settlements extended to the South, it is not possible to state, because all the cultural remains have been washed away by winter floods. The extent of the Neolithic settlements is therefore clearly confined to the sloping hillside between the two rivers mentioned above down to the border of the plain.

As stated above, the character of the site and its extension were first examined by trial pits. A trench was then dug through the eastern settlement in order to discover the area best suited for excavation. The area thus chosen was divided in squares, each with a side of 2 m., and was excavated in the same way as stated above (p. 2). The area of the western settlement too was excavated in the same way.

The work was in progress from the beginning of October to the middle of November 1928.



Fig. 10. Lapithos. Alonia ton Plakon with the Kerynia range in the background.

The eastern settlement

ARCHITECTURE (Figs. 12—14; Plan VIII)

The architectural remains of the eastern settlement have almost altogether disappeared from the causes mentioned below (pp. 16 ff.). Of the foundation walls of the houses, only a few pieces are preserved: in Squares E 3, D 3, E 4, and E 5. The only other remains are three bothroi, one in Square E 5, the second in Square F 5 and the third in Square E 3, a hearth in Square C 12, some portions of floors, and a few small pieces of undisturbed culture strata.

ARCHITECTURAL ELEMENTS

The parts of the stone foundations preserved consist of a single layer of rough stones. Of the construction of the upper walls and the shape of the houses or huts nothing can be said for certain as the evidence is too scanty.



Fig. 11. Lapithos. Alonia ton Plakon with the sea in the background.

The bothroi are all cut in the rock. The first bothros is circular in shape with an upper diameter of 1.23 m., somewhat narrower at the bottom. It is 2.17 m. deep; 0.80 m. from the bottom a niche is cut in the rock wall: it measures 0.57 m. in length, 0.64 m. in width and 0.62 m. in height.

The second bothros is of the same shape as the first; it has an upper diameter of 1.13 m. and is 1.63 m. deep. Contrary to the first bothros, it is wider at the bottom, and has no niche.

The shape of the third bothros was similar to that of the other ones but half of it has been cut off by the road.

The hearth found in Square C 12 consists of a circular cavity cut in the rock with a diameter of 1.60 m. and a depth of 0.81 m. From the bottom to within 0.15—0.20 m. of the top it is lined with rows of stones. The stones are all burnt by fire, and are embedded in sea-sand, which is compactly pressed and has become as hard as stone; on the inner face of the hearth this sand is also blackened by fire.

The floors, such as remain, consist of a stratum of trodden earth and *chavara* mixed with chips of stone; their different levels, the culture strata and their extent are made clear by the sections.

STRATIFICATION (PLANS VIII, 2; IX)

Section I runs through the northern part of the eastern settlement: it shows the few remains of the Neolithic settlement in this part, which the winter floods have not worn away. The average depth from the surface to the rock is only about 1.00 m.: the first layer is modern, cultivated earth; the second, Roman and Byzantine cultivation earth, mixed with a few potsherds from these periods; the third, a local accumulation of clay mixed with *chavara* along the first two metres, formed by the winter floods; the fourth and bottom layer consists of *chavara* earth mixed with a very few Neolithic potsherds; a local accumulation of ash and carbonized matter at meter 24 and directly above this layer, are the remains of a floor, built of stones embedded in a layer of gravel, *chavara* and compact earth. The hollow in the rock at meter 3 is a section of one of the ditches that were dug in the Roman and Byzantine fields to lead off the water.

Sections II, III, and IV cut through the eastern settlement from North to South and Section V crosses it from West to East.

Section II runs from the beginning of Section I down to the road. The layers of the first five metres correspond to the four layers of Section I: the first is modern, cultivated soil, the second Roman and Byzantine cultivation earth, the third clay mixed with pieces of *chavara*, brought down by the winter floods, and the fourth and bottom layer, *chavara* with sparse and disturbed Neolithic remains. At meter 5, the section cuts across a ditch dug in the Roman and Byzantine fields, at the bottom of which is a layer of sand and gravel brought there by the water. To the North of the ditch the stratification changes: the three uppermost layers are the same; the flooded layer only, is more richly mixed with *chavara* and gravel, but below this layer is a stratified deposit of intact Neolithic culture earth, resting on the rock, which descends abruptly from this point: for this reason the culture strata accumulated and were not worn away by the floodwater. The depth of the strata vary from 0.70—0.80 m. and they consist of a thick, compact earth, slightly reddish in colour, containing many potsherds and pieces of carbonized matter: these sherds are most frequent just above three strips hard earth and small chips of stone, and on the rock; these strips and the rock represent four different floor-levels marked N. 1—4 on Plans VIII—IX. The undisturbed culture strata are not very extensive, for at 6.20 m. they are entirely destroyed by the dromos-filling of Tomb 602 (see below pp. 267, 269) of the Geometric necropolis.

Section III is on the whole similar to Section II: at its southern end it cuts through the dromos of Tomb 601; and the intact culture strata start as in Section II at the point where the rock slopes down abruptly. There are, however, only three culture strata represented in this section corresponding to the three lowest strata of Section II, the uppermost stratum having been entirely washed away by floods as shown in Section V (see below). At about 7 m. the culture strata are interrupted in the same way as those of Section II, but the in-



Fig. 12. Lapithos. The eastern settlement.

interrupting layer is not the same, in that it consists of rather compact clay containing Neolithic potsherds: disturbed culture earth dug through by the tomb-cutters.

Section IV shows the same stratification and does not require a detailed commentary. There are three intact culture strata, the same as those of Section III. At 5 m. the section cuts through one of the ditches, and further down through the first bothros. Earth from the lowermost culture stratum has fallen into the upper part of the bothros, which was not already filled with the ordinary bothros refuse (cf. below), and the upper culture strata are accumulated on top of the filling of the bothros.

While the Sections II—IV show the extent of the Neolithic strata within the excavated area from North to South, Section V shows their extent from East to West. The strata at the east end of the section are interrupted by the dromos of Tomb 603 and at the west by that of an unexcavated tomb. The section also illustrates the gradual disappearance of the uppermost culture stratum of Section II towards Section III.

The stratification of the first bothros is made clear by Section IV and a cross-section VI, that of the second bothros by Sections VII and VIII*. The bothroi were filled with a homo-

* Drawings of these sections are not published.

geneous layer of refuse and showed no stratification: this consisted of dark, sticky earth, full of carbonized matter and potsherds, and apparently represented repeated clearings of the hearth: the hearth was sacred, and also its contents, which could not be simply thrown away, but had to be preserved from desecration by burial in the bothroi.

The inner part of the hearth was filled with compact earth, richly mixed with ash and carbonized matter, in which accumulated refuse were found many fragments of pottery, pieces of flint knives etc. The composition of this refuse, being identical with that of the bothroi, proves, further, that the refuse found in the latter comes from the sweepings of the hearth, as suggested above.

ARCHITECTURAL ANALYSIS AND SYNTHESIS

Four periods of habitation are thus represented by the four culture strata described above. In some squares the uppermost culture stratum has been washed away by the floods. It is possible, that other culture strata above the preserved ones have been washed away, so that there may have been more than four periods of habitation.

Summing up the evidence as regards the architectural remains and the history of the place as revealed by the stratification, we can state the following facts:

If we number these periods of habitation 1—4 the lowermost culture stratum representing Period 1, etc., then, on the basis of the stratigraphical evidence we are able to attribute the architectural remains to the different periods in the following way. The pieces of walls in Squares D 3 and E—F 4 belong to Period 1, as the culture stratum of that period goes right up to the walls and the culture stratum of Period 2 covers them. The bothroi, too, belong to Period 1; it was stated above that earth from the culture stratum of Period 1 had fallen into the upper part of the first bothros and that the culture strata of the later periods accumulated on the top of the refuse filling of the bothros. This is the last of the three bothroi, because the other two had already been filled with refuse before the end of Period 1, while the upper part of the first bothros was still empty at that time. Finally, the hearth, which is contemporary with the bothroi (see above) belongs to Period 1.

The remains of walls in Square E 5 above the first bothros are associated with the culture strata of Periods 2—3 and, consequently, belong to these periods, while the piece of wall in the south-western corner of the same square has to be assigned to Period 4, as it is founded on top of the culture stratum of Period 3.

The houses or huts were built on stone foundations consisting of a single course of rubble, but the plans of the buildings are entirely unknown in consequence of the fragmentary remains of the walls. The floors were made of earth mixed with *chavara*, gravel and stone chips. The hearths consisted of a circular cavity lined with a row of rubble, and their refuse was thrown into rock-cut bothroi.

After the site had been abandoned, the culture strata and the architectural remains were, to a great extent, washed away by floods; subsequently they were much disturbed in the Geometric period, when the place was used as a necropolis, when the tombs were cut

LAPITHOS
EASTERN SETTLEMENT

Plan

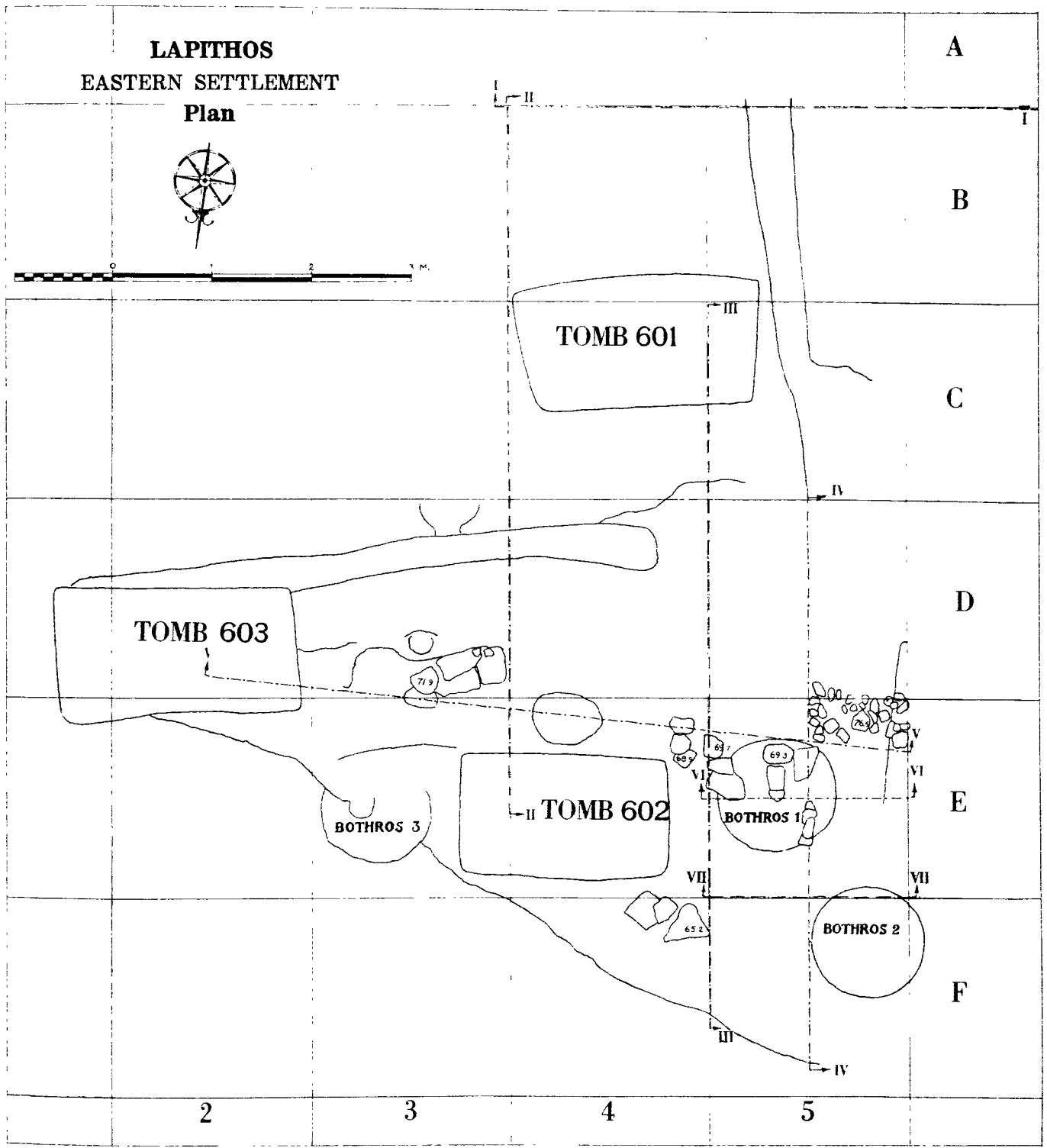
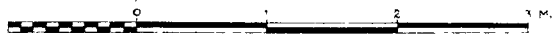

1

Sections

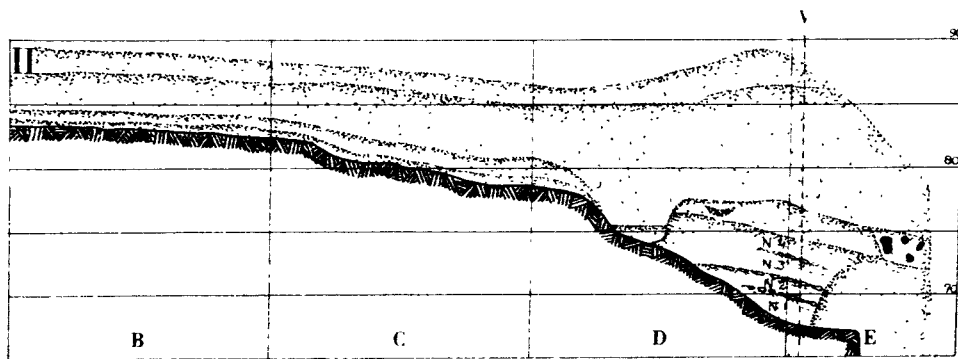
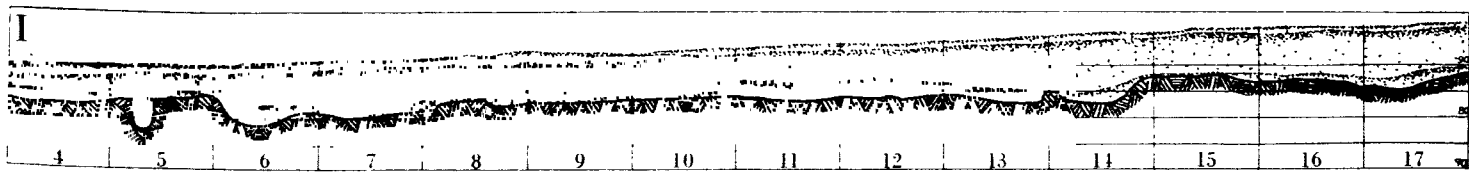

2

Sections

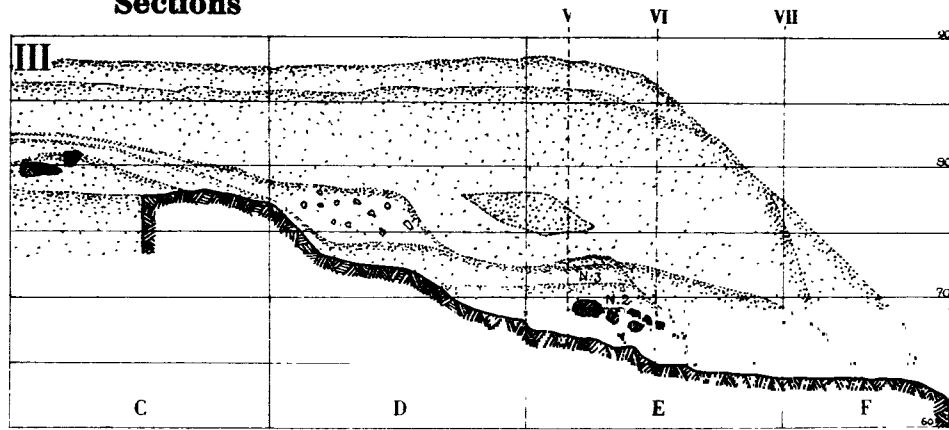

THE HEARTH
Plan

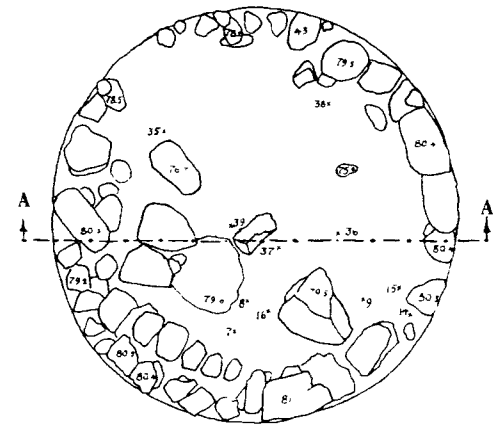

Section

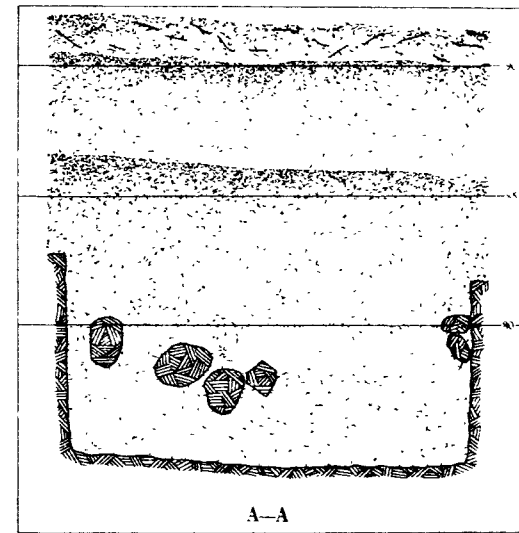

A-A

2

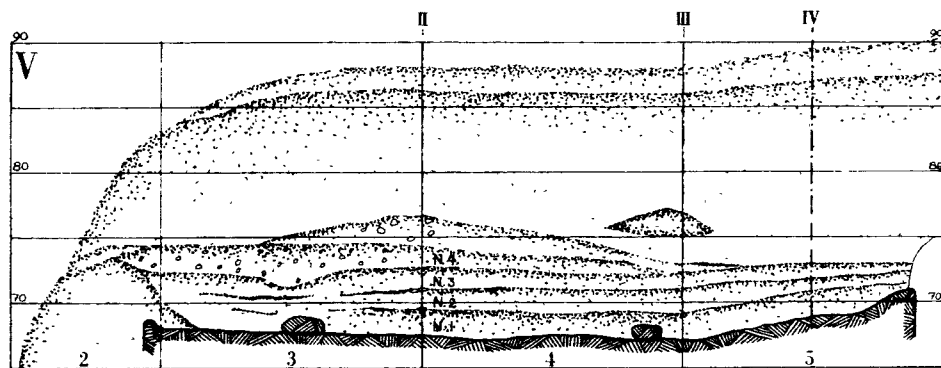
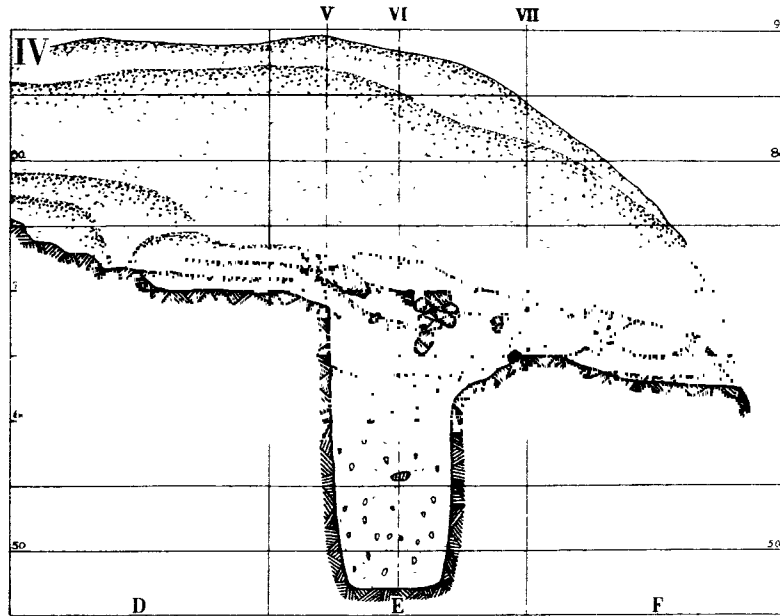
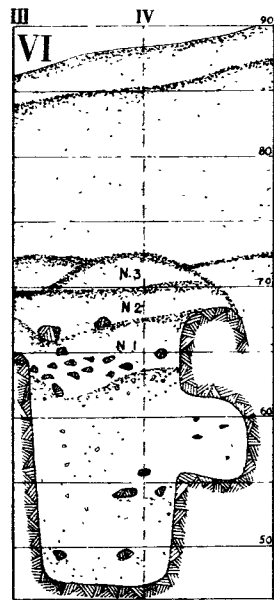

1



Fig. 13. Lapithos. The hearth in the eastern settlement.



Fig. 14. Lapithos. Bothros 1 of the eastern settlement.

very close to each other in the rock, and the stones used for closing the doors of the tombs were taken from the foundations of the Neolithic houses. Finally, in the Roman and Byzantine periods, when the place was cultivated, ditches were dug in the field, down to and partly in the rock, to carry off the water, and still further disturbed the Neolithic remains. Considering all these disturbances it is not surprising that so little of the Neolithic architecture is left, but rather that anything at all remains.

The excavation of the eastern settlement is, therefore, of purely stratigraphical importance, and only the parts with undisturbed culture strata, and the waste layers of the bothroi are of archaeological value.

The western settlement

ARCHITECTURE (Fig. 15; Plan X)

A trial trench on this site showed that the earliest culture stratum of the eastern settlement was not represented here, but that the architectural remains were much better preserved, as the necropolis of the Geometric period did not extend to this part of the settlement. A part of it was, therefore, excavated in order to throw some light upon the architecture of the period.

ARCHITECTURAL ELEMENTS

Remains of four huts, one above the other, were found in four successive culture strata. The preserved foundation walls are numbered 1—5. They are all of similar construction and consist of one, or occasionally, two courses of unhewn stones of various sizes and kinds:



Fig. 15. Lapithos. The hut of the western settlement.

pebbles, conglomerate, and limestone. The construction is very loose and irregular; occasionally a large stone forms the whole width of the wall; in other places, smaller stones, meeting in the middle, are used, or the wall is faced with stones of varying sizes, with an inner filling of small stones and gravel. Of Wall 1, which is curved and about 0.50 m. wide, only a short piece is preserved. The wall is partly built over by Wall 2. This wall too is curved and it is in a better state of preservation. It has an average width of 0.60 m. The remains of Wall 3 were not found *in situ* but lay accumulated in a ditch excavated by a water course (see below p. 22). Its construction and measurements, therefore, are not certain. Wall 4 is straight and preserved for a length of 2.80 m. It is approximately 0.60 m. in width. Of Wall 5, only a small portion in square D 6 is preserved (cf. Fig. 19).

The upper walls are altogether destroyed and their construction is therefore a matter of conjecture. As shown by the stratification (cf. below) clay was used abundantly but probably only as a binding material for a framework of straw and wattle. No traces, or impressions of this could, however, be discovered, but the evidence of the Kythrea huts (pp. 281 f.) speaks in favour of this supposition.

The floors consist of either packed earth (floors of Huts II and III), or of rammed earth mixed with small stones (floors of Huts I and IV).

Indications as to the construction of the roof are given by the stratification (cf. Sections I and IV, Plans X, 2; XI), which shows that the roof was supported by wooden posts.

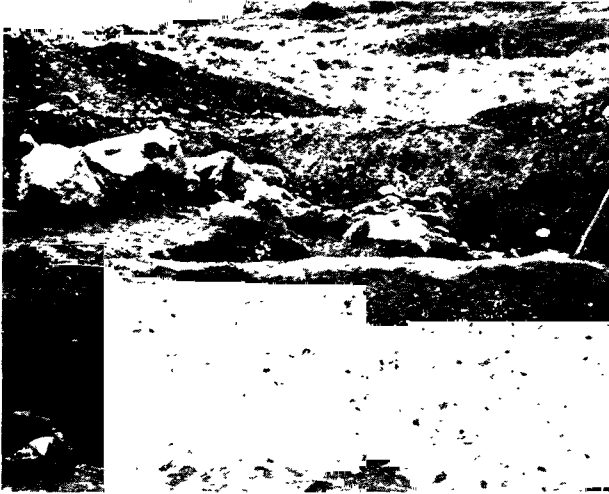

Fig. 16. Lapithos. The western settlement. Filled holes for wooden posts in the longitudinal axis of the hut.



Fig. 17. Lapithos. The western settlement. Filled hole for wooden post (Square A 4).

It seems probable that straw bound together by clay, was used as building material for the roof (cf. below p. 25).

Three hearths were found. Hearth 1 consists of an oblong platform with rounded corners built of pebbles, and is slightly raised above the floor-level. Hearths 2 and 3 are of a different type and consist of a circular cavity, roughly circular in shape, sunk in the floor, in a way similar to that of the hearth found in the eastern settlement.

STRATIFICATION (FIGS. 16—19; PLANS X, 2; XI)

Description of layers.

Section I.

This section runs through the medial axis of the huts, from Square A 4 to D 4. It is composed of the following layers.

1. A surface layer of accumulated cultivation earth, at the bottom mixed with Neolithic culture remains and resting on a floor of rammed earth partly mixed with small stones. This floor abuts on Wall 2.
2. Below this floor is a culture stratum of dark, fatty earth, mixed with ash and carbonized matter. The layer rests on a floor-level of rammed earth. Circular pits tapering towards the bottom, and filled with the dark earth of the culture stratum, cut into the lighter layer 3. These pits are to be interpreted as holes for wooden posts supporting the roof, which have decayed later on, and the holes became filled with the earth from Stratum 2. Wall 2 is founded in this stratum. The relation of

this stratum to Wall 1 is not shown by Section I as the remains of that wall are very fragmentary in this place. It can be stated, however, that the stratum abuts on this wall at places where it is better preserved.

3. The third layer consists of packed earth lighter than that of the preceding layer; it is mixed with more pieces of *chavara* representing a successively raised floor-level, which was formed by the accumulation of rubbish. Circular pits, similar to those of the second layer but filled with the light earth of this layer, cut into the darker fourth stratum. It is worth noting that the pits are situated directly below those of Layer 2. This stratum abuts on the scanty remains of Wall 1.
4. Below this floor there is a culture stratum of dark, fatty clay mixed with ash and carbonized matter.
5. This culture stratum rests on a floor of earth and small stones, raised successively like the floor of Layer 3. On the south side, the floor rests on the rock; to the North, where the rock slopes down rather abruptly, the floor is laid on the virgin bottom strata (6—7).

6—7. Virgin bottom strata of clayey earth mixed with *chavara* and rock.

Section II.

This section runs from Square A 2 to D 2. The stratification conforms to that of Section I, and a minute description of the layers is, therefore, superfluous. It is to be observed that, at the north end of the section, where the rock slopes abruptly down, the virgin bottom strata are four in number (Layers 6—9). From Square C 2 to the end of the section, the layers 2—5 are cut through by a ditch filled with alluvial sand and gravel mixed with mud embedding the stone foundation of Wall 3. The mud seems to be the remains of the clay-filling of the upper walls. It is evident that the ditch marks the course of a temporary winter torrent which had come down the hillside, breaking through the west wall of the hut and cutting a deep ditch through the earth of the culture strata down to the virgin bottom strata. This catastrophe happened at the end of the period represented by Layer 2, since that layer has been cut through by the ditch, while the floor of Layer 1 passes on top of it. This floor abuts on Wall 2; Wall 4 is founded in the upper filling of the ditch and the floor of Layer 1 abuts on it.

Sections III—V.

These sections run through the north part of the excavated area: Section III the north side of Squares A 2—A 6; Section IV in the middle of Squares A 2—A 6; and Section V between Squares A and B. All these sections display a stratification which is identical

with those of the cross-sections I—II. The ditch of Section II appears in all the sections and thus gives an idea of its width. Section V cuts through the hearth of Floor 5 and shows that this successively raised floor abuts on the hearth. Wall 5 is also cut through by this section. It is founded in the bottom layer 6 and Stratum 5 abuts on it. This stratum changes on top of Wall 5 where it consists of clay mixed with organic earth, apparently remains of the decomposed upper wall (cf. Sections XIII, XIV, Plan XI, 2).

Sections VI—XIV.

These sections are cross-sections between Sections III and V. Their stratification is identical with that of these sections and, therefore, does not require description. Their purpose is to show the northern limit of the different floors, in order to fix the extension of the huts in this place.

Periods.

The description of the layers has shown that there are four periods of habitation: the first period is represented by Floor 5 and Stratum 4; the second period by Floor 3; the third period by the floor-level and Stratum 2; and the fourth period by the floor and culture earth of Layer 1. The homogeneity of the finds in the strata of these periods (cf. below) shows that they do not represent chronologically different epochs but only successive periods of habitation of the same epoch. The stratigraphical and architectural evidence point in the same direction (cf. below, Architectural synthesis): Periods 2 and 3 are represented by different floors which belong to one and the same hut; furthermore, the identical shape of all the huts shows that the later huts were only rebuildings or substitutes for the earlier ones.

ARCHITECTURAL ANALYSIS

The architectural elements described above can, on the basis of the stratigraphical evidence, be attributed to the different periods of habitation as follows.

Wall 5 and the hearth of Floor 5 belong to the first period as this floor abuts on both, and the floor of the second period lies on top of the culture stratum of Period 1.

Walls 1 and 3 seem to belong to the second and third periods. Wall 1 must be earlier than Wall 2, as the latter is built partly on top of it. Wall 2 belongs to the fourth period (cf. below) and Wall 1 must, therefore, be earlier than the fourth period. On the other hand, it is founded in Stratum 4 and Strata 2 and 3 abut on it: it must therefore be later than the first period and contemporary with the second and third periods.

Wall 3 must be earlier than the fourth period because the floor of that period passes on top of the ditch in which are the remains of the wall. As the winter torrent of this ditch has cut through all the culture strata below the floor of Layer 1, it is evident that the silt of the ditch is mixed with elements from all these strata, but it seems natural to suppose that Wall 3 represents remains of the wall of the hut existing at the time of the torrent, i. e. the end of Period 3. Wall 3, therefore, should be contemporary with Wall 1 and belong to Periods 2—3.



Fig. 18. Lapithos. The western settlement.
Walls 3 and 4.

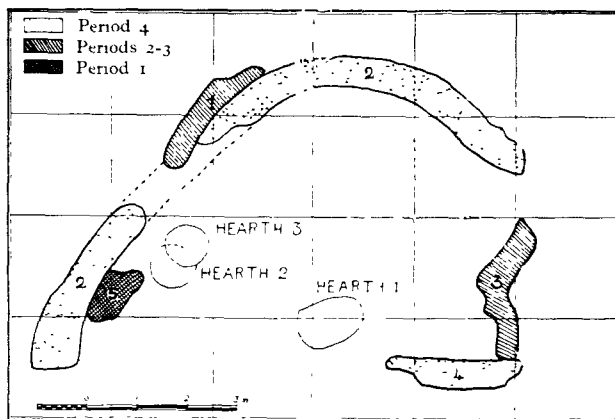

Fig. 19. Lapithos. The western settlement.
Analytical plan of the huts.

Walls 2 and 4 belong to the fourth period, as they are founded in the culture stratum of Period 3 and the floor of the fourth period abuts on them.

Finally, it can be stated, from their relation to the respective floors, that Hearth 2 belongs to the second and third periods, and Hearth 3 to the fourth period.

ARCHITECTURAL SYNTHESIS

Summing up the architectural and stratigraphical evidence we obtain the following results:

There are four periods of habitation, represented by successive culture strata with remains of a large hut in each.

The huts were all built on foundations of one or two courses of rubble; the upper walls were probably of straw and wattle bound with clay.

The extent and shape of the hut of the first period are traceable only from the edges of the floor, as, apart from the wall fragment 5, the walls are destroyed. It turned out that the floor of the hut had approximately the same extension as those of the later huts, and it is therefore evident that the shape of the hut must have been similar: the plan is semicircular, with a diameter forming a straight front to the North, and the whole covered by a semi-vaulted roof, so that the hut had the shape of a half-dome (cf. below). No traces of wooden posts supporting the roof could be detected, as opposed to the conditions in the second hut, but this may be explained by the structural difference between the floors of the two huts: in the earth floors of the second hut the holes for the wooden posts were visible (cf. above and below); the floor of this hut consisted, as stated above, of packed earth and pebbles, and if the posts rested directly on this floor there were naturally no traces left of them. The front was probably open or covered by a curtain (cf. below).

In Squares A—B 3—4 the hearth (Hearth 1) is situated close to the middle of the front

of the hut. From constant use, the level of the floor became gradually raised about 0.30 m. above the original level, so that it nearly reached the top of the hearth.

The second hut was erected on the debris of the first hut. Of its stone foundations, Walls 1 and 3 are preserved, but to such a small extent that the original line of the walls and the extent of the hut can be determined only by the extent of the floor. The floor-level has approximately the same limits as those of the first hut, and the plan of the hut must therefore have been that of a semicircular building, with the arc of the semicircle to the East, South, and West and a straight front facing the North. The earth floor became gradually raised in the same manner as that in the first hut, by the accumulation of rubbish on which new floor-levels of packed earth were laid.

The roof was supported by wooden posts. There were six such posts along the transverse axis of the hut; the centre of the first being 0.90 m. from the south wall, and the distance between this and the second is 0.90 m., between the second and third 0.83 m., between the third and fourth 0.57 m., between the fourth and sixth 2.05 m., and between the fifth and sixth 0.82 m. The sixth post was in a line with the north front of the hut. The second and sixth posts were thicker than the others, their diameter being about 0.20 m., while that of the others was about 0.10—0.15 m. The roof supported by these six wooden posts has probably been built as a continuation of the hut walls on a substructure of curved straw bound with clay, forming the wall. Of such a roof, supported by wooden posts, there are many parallels in primitive architecture (cf. Oelmann, *Haus und Hof im Altertum*, pp. 98, 102).

Besides these a seventh post was situated on the north front, in a line with the sixth post and about 0.75 m. from the end of the east wall. The pit of this post is much larger than those of the rest, its diameter being about 0.35 m. The wooden post standing in this pit, consequently, must have been the thickest used in this hut. What was its purpose? There were no remains of a front wall, and one must therefore consider the possibility that the front of the hut was entirely open, in which case the constructive purpose of wooden posts in front would, apparently, have been to support the wooden beams on which the roof rested. Such huts with open fronts covered by a curtain of soft material are common in primitive architecture (Oelmann, *op. cit.* pp. 22 ff., 61). Remains of the hearth (Hearth 2) of this hut were found near the middle of the east wall.

The hut of the third period is only a rebuilding of the second-period hut: the hearth of the latter hut was still used; the walls of the two huts were the same, or were possibly repaired in the third period, and only a new floor was laid, with new wooden posts to support the roof. These posts, both those in the transverse axis of the hut and the posts in the front, were placed exactly above those of the second-period hut.

The hut was destroyed, in the way illustrated by the Section II (cf. above) by a temporary winter torrent breaking through the west wall of the hut and cutting a deep ditch through the earth of the culture strata.

After this catastrophe, a new hut was built similar to the one destroyed. The stone foundations (Walls 2 and 4) are rather well preserved and prove that the plan of the hut is

still that of a semicircular building with a straight front wall so that the hut had the shape of a half-dome. It is not possible to fix the exact situation of the entrance, as only the western part of the front wall is preserved. Possibly, the entrance was at the eastern end of the front wall. There were no traces of wooden posts supporting the roof; which may be explained by the pebble floor of this hut (cf. above, the first hut).

The hearth is of the same construction as that of the preceding hut and is in the same position, but rather more to the South.

FINDS (Pls. IX, X, XCIII: 5, 6, 14—16)

OBJECT REGISTER

1. Fragment of chisel of basalt with flat sides and nearly straight cutting edge; polished; upper part missing. Length 2.4. Trial pit 1. 86.5.*
2. Flake of white flint. Length 3.8. Trial pit 1. 84.0.
3. Flake of white flint. Length 3.2. Trial pit 1. 82.5.
4. Splinter of buff-brown flint; narrow and triangular in section; curved. Length 3.3. F 9.** 82.6.
5. Splinter of grey-blue flint; rather thin and wider than No. 4; curved. Length 3.2. F 9. 80.1.
6. Nucleus of red and whitish-blue flint. Length 4.4. C 12. 82.4 (on rock).
7. Flake of dark-brown flint, pyramidal in shape. Length 3.4. C 12 (the hearth). 79.7.
8. Nine small splinters of red-brown, light-brown and grey-blue flint. Length 1.6—3.5. C 12 (the hearth). 79.7.
9. Splinter of cream-coloured flint; thin. Length 2.7. C 12 (the hearth). 78.7.
10. Splinter of blue-grey flint; curved and thin. Length 2.7. F 12. 77.1.
11. Splinter of cream-coloured flint; triangular in section. Length 3.8. F 15. In sieves.
12. Flake of white flint; roughly triangular in shape. Length 2.4. F 12. In sieves.
13. Two small thin splinters of red-brown flint. Length 1.8. F 12. In sieves.
14. Splinter of red-brown flint; triangular in section. Length 2.3. C 12 (the hearth). 78.2.
15. Triangular nucleus of light-brown flint. Length 3.4. C 12 (the hearth). 77.9.
16. Two splinters of red-brown and light-brown flint; thin and irregular. Length 2.9; 1.7. C 12 (the hearth). 77.7.
17. Small fragment of chisel of uralite-porphyrite; a triangular part near the cutting edge preserved; polished. Length 1.7. B 15. 82.5.
18. Flake of red-brown flint with white streaks. Length 2.2. E 12. 79.5.
19. Piece of burnt bone. Length 2.9. C 12 (the hearth). 75—76 (in sieves).
20. Five small splinters of red-brown, grey, and cream-coloured flint. Length 1.4—2.3. C 12 (the hearth). 75—76 (in sieves).
21. Splinter of brown flint, rather thin and flat. Length 2.4. C 12. Surface layer.
22. Flake of dark-brown flint, pyramidal in shape. Length 3.0. B 8. 85.7.
23. Cockle-shaped scraper of cream-coloured flint; with curved, retouched edge and semi-segmental in section. Length 3.6. B 6. 83.5.
24. Splinter of greenish-brown flint, roughly oval in shape, thin. Length 2.7. C 4. 81.1.
25. Splinter of white flint, roughly rectangular, triangular in section. Length 4.1. C 4. 81.9.
26. Splinter of light-brown flint, thin and spade-shaped. Length 1.9. C 4. In sieves.
27. Splinter of brown flint, rather wide and short. Length 4.0. D 4. 75.2.
28. Axe-head of basalt with rounded, slightly convex sides, oval in section, with curved cutting edge; upper part missing. Length 10.5. E 4. 73.0.
29. a—b Thirty small splinters and flakes of various kinds of the usual flints. Length 1.5—3.5. E 4. 73.0.
30. Axe-head of uralite-porphyrite; flat and thin; narrow, square-cut top, and nearly straight cutting edge; polished. Length 5.6. F 4. On the rock.
31. Axe-head of basalt; similar to No. 30, but with rounded sides and elliptical in section; polished; one side and cutting edge chipped. Length 9.0. F 4. On the rock.
32. Axe-head of basalt; oval in section, narrowing and thickening towards the rounded top; nearly straight cutting edge; polished. Length 5.7. Western hut D 2. 83.5.
33. Chisel of amygdaloidal basalt; with convex, flat body, convex, flat sides, and straight cutting edge; polished; upper part missing. Length 4.3. Western hut. Stray find.
34. Thirtythree usually small splinters of different kinds of the usual flints. Length 1.9—3.9. D 3. 70—71.
35. Scraper of red-brown flint; wide, leaf-shaped and thin with retouched edges. Length 4.7. C 12 (the hearth). 70—71.
36. Grindstone of basalt; circular, with flat bottom and flattened upper side; bottom polished. Diam. 9.7. C 12 (the hearth). 70.2.
37. Chisel of basalt; thin, flat, with straight top; convex, rounded and flattened sides, straight cutting edge; polished; top slightly damaged. Length 6.9. C 12 (the hearth). 77.0.

* Level.

** Square.

38. Axe-head of aphanitic basalt; oval in section, with convex, rounded sides; narrow top; curved edge; unfinished; upper part and one side chipped off. Length 10.0. C 12 (the hearth). 76.3.
39. Scraper of red-brown flint with white and blue streaks; cockle-shaped, with retouched edge. Length 9.5. C 12 (the hearth). 78.1.
40. Axe-head of basalt; oval in section, with nearly straight sides, and curved cutting edge; polished; upper part missing. Length 7.2. Western hut B 5. Floor 2.
41. Knife of cream-coloured flint, with straight top, single cutting edge, one side flat, the other with flat top-ridge, curved upper end; edge retouched from one side; point broken. Length 9.0. Western hut B 5. Floor 2.
42. Disc-shaped amulet of light-blue steatite pierced by a hole approximately in the centre. Diam. 3.2. Western hut B 5. Floor 2.
43. Axe-head of basalt; rather thin and flat, elliptical in section, with slightly curved sides, tapering upwards; straight top; curved cutting edge; edge polished. Length 9.0. C 12 (the hearth). 79.1.
44. Axe-head of basalt; oval in section, with slightly curved sides, tapering upwards; rounded, thick top; curved cutting edge; edge polished. Length 9.5. C 12 (the hearth). 78.0.
45. Knife of brown flint, roughly triangular with rounded, double cutting edge; flat top ending in a midrib towards the point, and a projection at the upper end for fixing the handle. Length 3.7. D 5. 69.5.
46. Axe-head of basalt and dolerite, oval in section, narrow, curved cutting edge; upper part missing. Length 8.8. Western hut A 3. Floor.
47. Axe-head of basalt, oval in section, with convex sides and nearly straight cutting edge; upper part missing. Length 8.7. Western hut A 3. Floor.
- 48 a—b. Sixteen splinters and flakes of red, brown, cream-coloured, and grey flint. F 5 (Bothros II). 60—63.
- 49 a—b. Eleven flint splinters and flakes of the same kind as preceding. F 5. 63—59.
- 50 a—b. Twentyfive flint splinters and flakes of the same kind as preceding. E 3. 73—71.
- 51 a—b. Thirteen flint splinters and flakes of the same kind as preceding. E 3. 70—68.
- 52 a—b. Twentyfour flint splinters and flakes of the same kind as preceding. D 5. 72—70.
53. Piece of carbonized dikotyledon. E 3. 73—71.

Beside these numbered finds, there were discovered numerous fragments of pottery and flint chips.

CLASSIFICATION

The finds may be classified in three main divisions: objects of flint, stone, and pottery. The flint is of varying colours and degrees of hardness. The red-coloured variety is rather unusual, while the brown-coloured flint is very common. Besides there are various shades of cream-coloured, grey, and white flint. The red-brown and cream-coloured flints are hard and lustrous; the grey flint is less hard and mat, and the white flint is mat and rather soft. The majority of the flints consist of cores, flakes, and splinters. The specimens of the latter used as instruments are scrapers (Nos. 23, 35, 39) and knives (Nos. 41, 45). The scrapers are either thin, spade-shaped (No. 35) or thick, and cockle-shaped (Nos. 23, 39) with retouched edge. The knives are leaf-shaped or triangular with single or double cutting edge, retouched or unretouched, flat or angular ridge.

The stone objects consist of chisels, axe-heads, hammer, grindstone, and an amulet. The chisels (Nos. 1, 17, 37) are flat, thin, and with straight edge. The axe-heads are of two main types: Type 1: flat axes (Nos. 31, 33), and Type 2: roundish axes (Nos. 28, 32, 38, 40, 43, 44, 46, 47). The flat axes have a narrow top and straight or curved cutting edge. The roundish axes have usually a curved, rarely a straight, cutting edge; the top is narrow and the cutting edge wide, except in one case (No. 46) which has a narrow edge.

The grindstone (No. 36) is circular, with a flat bottom and a flattened upper side and the amulet (No. 42) is irregularly disc-shaped and pierced by a hole.

The chisels, axe-heads, and the grindstone are of basalt or uralite-porphyrite and the amulet of steatite.

The pottery consisted of the following classes:

- I. Red Polished Ware.
- II. Plain White Ware.
- III. Painted Ware.

I. Red Polished Ware.

Technique.

The clay is usually gritty, hard and coherent. The colour varies according to the different degrees of firing and is seldom brown all through, as is the case when the carbon is burnt out. In section, it is usually black in the centre and brown at the edges; occasionally it is black throughout except for a thin, brown layer at the outer surface and occurs mostly in the larger jugs and other closed vessels.

The body is covered with a thin coating of silted clay, and a red polished slip. The coating is either dark-brown or buff in colour, the buff coating flaking off rather easily. The slip at times, though infrequently, is polished, but mat and flakes off so easily, that sometimes only small traces of it remain or it is entirely absent. Owing to the differences in firing, the slip sometimes takes a black tone, or is brown or yellowish-buff in colour. The sherds with effaced red slip can often be mistaken for Plain White Ware (cf. below).

Shape.

So far as known, the shapes represented are bowls, jars, and jugs. The bowls are of different kinds; bowls with flat or flattened base, straight, splaying sides, rim plain or splaying outwards; deeper bowls with similar base, straight or slightly convex sides, similar rim and a tubular spout near the rim; deep bowls with slightly convex or straight sides, plain rim and a vertical ledge-handle near the rim; deep bowls with straight or slightly convex sides and rim turned outwards. The jars have a flat base, or a base-ring, convex sides, wide mouth with rim turned outwards. The jugs have a pointed, rounded bottom, oval body and concave, long neck narrowing at the top and with slightly flaring rim; no handles or string-holes.

Decoration.

This ware is, as a rule, plain. Only in one case, a relief decoration of notched string has been noted.

II. Plain White Ware.

Technique.

The clay of this ware is similar to that of the Red Polished Ware. It is covered with a whitish-buff coating similar to that of the Red Polished Ware; the surface in the better specimens is

more or less polished. Usually, it is mat, and, at the end of the Stone Age especially, of an inferior quality, flaking off easily. The shade of the slip is sometimes brownish-yellow, in which case it forms a transitory type between the Plain White and Red Polished Wares. In cases where the red polished slip is effaced, the Red Polished sherds may sometimes, as stated above, be mistaken for Plain White Ware.

Shape.

So far as ascertained the shapes of this ware are similar to those of the preceding ware.

Decoration.

This ware is entirely undecorated.

III. Painted Ware.

Technique.

The clay is similar to those of the preceding wares. It is covered with a whitish-buff slip, polished or mat. On this slip the designs are painted with a red, brown or dark paint, either polished or mat.

Shape.

So far as ascertained the shapes of this ware are the same as those of the preceding wares. One base with four projections should be noted.

Decoration.

The decorative elements consist exclusively of geometrical designs: plain lines; fringed lines; parallel lines, fringed parallel lines; crossed lines; filled bands, single and parallel; bands of parallel lines; hatched or latticed bands; areas framed by parallel lines or filled bands; bands and areas of concentric wedges, framed by parallel lines; a rope-ladder pattern; hatched and latticed lozenges and rectangles; fringed lozenges; latticed triangles framed by parallel lines; a series of latticed or hatched lozenges; a fan-pattern.

These decorative elements can be divided into two different styles:

1. *The line and band style*, in which only lines, parallel lines, cross lines, and filled bands, single or parallel, are used. These lines and bands cover the body of bowls and jugs in free and vigorous strokes.

2. *The patterned styles*. As decorative elements, all the above mentioned motifs are used. These designs are mostly composed in a vertical-horizontal system, usually with a

horizontal border of a lattice-work, a band of concentric wedges etc. at the rim and at the lower end, and a vertical arrangement of motifs round the body; but most of the pottery fragments are too small to give any idea of the general style of composition. As a rule, the style is vigorous and vivid, and there is no strained observation of symmetry. The designs are accordingly large and freely drawn: e. g. a series of large latticed triangles etc. sometimes cover the whole body of the vessels. Occasionally a filling ornament of a lozenge, etc. is used in the empty spaces between the vertical bands and areas.

The fan-pattern is sometimes used to decorate the spouts of the bowls, sometimes as a single, free ornament on the inside of the bowls, which have on the outside, the strict vertical-horizontal system of composition.

RELATIVE CHRONOLOGY

The distribution of the different classes of pottery, from the strata of the eastern settlement, in their various layers, is shown in the diagram below:

		4th period	3rd period		2nd period		1st period				
			a*	b*	a*	b*	a*	h*	c*	d*	
D 3	R. P.	110	79	76	55	36	38	30	11	—	
	Pl. Wh.	51	38	45	19	11	12	15	7	—	
	Painted	16	24	30	19	14	14	12	8	—	
E 3	R. P.	92	129	105	162	153	164	130	102	18	
	Pl. Wh.	35	54	57	69	56	65	52	39	5	
	Painted	11	32	28	41	49	58	40	44	4	
D 5	R. P.	—	65	76	90	202	156	103	—	—	
	Pl. Wh.	—	27	30	32	77	59	48	—	—	
	Painted	—	14	12	26	55	47	48	—	—	
E 5	R. P.	—	138	167	79	160	183	89	34	63	
	Pl. Wh.	—	60	76	33	73	95	39	12	27	
	Painted	—	25	43	22	58	56	26	10	26	
		0—10**	10—20	20—30	30—40	40—50	50—60	60—70	70—80	80—90	90—100
E 5, Bothros	R. P.	22	11	17	4	11	49	27	52	26	25
	Pl. Wh.	15	11	8	9	7	25	6	26	4	16
	Painted	15	11	7	3	9	48	28	35	6	27
		100—110	110—120	120—130	130—140	140—150	150—160	160—170	170—180	180—190	
E 5, Bothros	R. P.	36	15	30	33	12	37	14	4	3	
	Pl. Wh.	22	14	10	27	11	29	13	5	2	
	Painted	35	17	12	21	15	16	15	8	3	

* A, b, c, d indicate successive levels within the culture stratum of each period.

** Measurements given in centimeters from top of bothros filling.

This diagram shows the distribution of the pottery calculated on percentage:

		4th period	3rd period		2nd period		1st period					
			a	b	a	b	a	b	c	d		
D 3	R. P.	62	56.0	50.4	59.4	59.0	59.4	52.7	42.3			
	Pl. Wh.	28.6	27.0	29.8	20.4	18.1	18.8	26.3	26.9			
	Painted	9.4	17.0	19.8	20.2	22.9	21.8	21.0	30.8			
E 3	R. P.	67.7	60.1	55.3	59.5	59.3	57.2	58.6	55.1			
	Pl. Wh.	25.4	25.1	30.0	25.4	21.7	22.6	23.4	21.1			
	Painted	8.0	14.8	14.7	15.1	19.0	20.2	18.0	23.8			
D 5	R. P.		61.3	64.5	60.8	60.4	59.6	51.8				
	Pl. Wh.		25.3	25.3	21.6	23.1	22.5	24.1				
	Painted		13.4	10.2	17.6	16.5	17.9	24.1				
E. 5	R. P.		61.9	58.4	59.0	55.0	54.8	57.8	60.7	54.4		
	Pl. Wh.		26.9	26.6	24.6	25.1	28.4	25.3	21.4	23.4		
	Painted		11.2	15.0	16.4	19.9	16.8	16.9	17.9	22.2		
		0—10	10—20	20—30	30—40	40—50	50—60	60—70	70—80	80—90		
E 5, Bothros	R. P.		42.4	33.3	53.1	25.0	40.8	40.2	44.3	46.0	72.3	
	Pl. Wh.		28.8	33.3	25.0	56.3	25.9	20.5	9.8	23.0	11.1	
	Painted		28.8	33.3	21.9	18.7	33.3	39.3	45.9	31.0	16.6	
		90—100	100—110	110—120	120—130	130—140	140—150	150—160	160—170	170—180	180—190	
E 5, Bothros	R. P.		36.8	38.7	32.6	57.7	40.7	31.5	45.1	33.3	23.5	37.5
	Pl. Wh.		23.5	23.7	30.4	19.2	33.4	29.0	35.4	31.0	29.4	25.0
	Painted		39.7	37.6	37.0	23.1	25.9	39.5	19.5	35.7	47.1	37.5

From these diagrams it is evident that the first period of occupation in the eastern settlement is represented by equal quantities of Red Polished and Plain White pottery and two or three times as much Red Polished as Painted pottery. In the second and third periods, there is a gradual increase of Red Polished Ware in proportion to the Painted Ware, while the percentage of the Plain White Ware is fairly constant. In the fourth and final period, this process has been continued, 7—8 times as much of the Red Polished Ware being found as of the Painted Ware. The general tendency is therefore for the quantity of the Red Polished Ware to increase, and that of the Painted Ware to decrease, while that of the Plain White ware is fairly constant during the whole period of occupation represented by the preserved layers of the eastern settlement.

The pottery series of the bothroi, as exemplified by the statistical diagram of the potsherds found in the bothros in E 5, is differently composed, the percentage of the Painted Ware being about the same as that of the Red Polished Ware. As stated above, the refuse of the rock-cut bothroi must be connected with the first period of occupation, but there is still a much greater percentage of Painted pottery found in the bothroi, than in the corresponding culture stratum. This curious fact may be explained from the point of view of the sacred nature of the refuse in the bothroi: probably only the more beautiful, and artistic of broken

pots which had been used for sacred purposes, or had contained offerings, were buried together with the refuse in the bothroi.

The pottery of the western settlement consisted nearly exclusively of Red Polished Ware, of the same kind in all the four successive culture strata. Only a small quantity of Plain White fragments and a few sporadic specimens of Painted Ware (in all the four culture strata) were found together with a great mass of Red Polished ware. This ware is usually of the type with a red polished slip on a thin, silted coating, on a dark-brown clay, while the type with a buff coating is rather rare. The pottery is also generally of the technically inferior quality as to firing, slip, polish etc. (cf. above p. 28); many of the sherds crumble into small pieces, and the slip is often nearly effaced.

The stratigraphical evidence for the chronological relations between the eastern and western settlements was missing as there was no actual connection between them, but this statistic record of finds proves that the western settlement is later in date, if the two following facts are considered. 1st: The latest preserved culture stratum of the eastern settlement shows a great decrease of the Painted Ware, and an increase of the Red Polished Ware; 2nd: The early Copper and Bronze Age pottery is exclusively Red Polished Ware. The finds of the western settlement form an intermediate stage between these and should, therefore, be considered as belonging to the end of the Neolithic period. The eastern and western settlements consequently, represent two Neolithic periods, one earlier comprising four successive periods of habitation and characterized by a mixture of Red Polished, Plain White, and Painted Ware, of which the latter class of pottery decreases towards the end of the period; and a later period also comprising four successive periods of occupation characterized by a predominance of Red Polished Ware, with a few survivals of Plain White and Painted Wares.

The non-ceramic objects, according to the position in which they were found (see Object Reg.) are distributed among the periods, as shown by the following diagram:

	F l i n t						S t o n e				Bone		
	Core	Splinter	Flake	S c r a p e r		K n i f e		Chisel	A x e - h e a d		Grinder	Amulet	Piece
				unretouched	retouched	unretouched	retouched		flat	round			
Eastern settlement	6, 15 10, 11, 13 14, 16, 20 21, 24, 25 26, 27, 29a 34, 48a, 49a 50a, 51a 52a	4, 5, 8, 9 18, 22 29b, 49b 50b 51b 52b	7, 12	23 35 39	45	17 37	30 31	28 38 43 44	36	42	19		
Western settlement	-2	-22	-9	-3	-1	-2	-2	-4	-1	-1	-1		
			2 3 -2		41 -1	1 -1	32, 40 46, 47 -4						

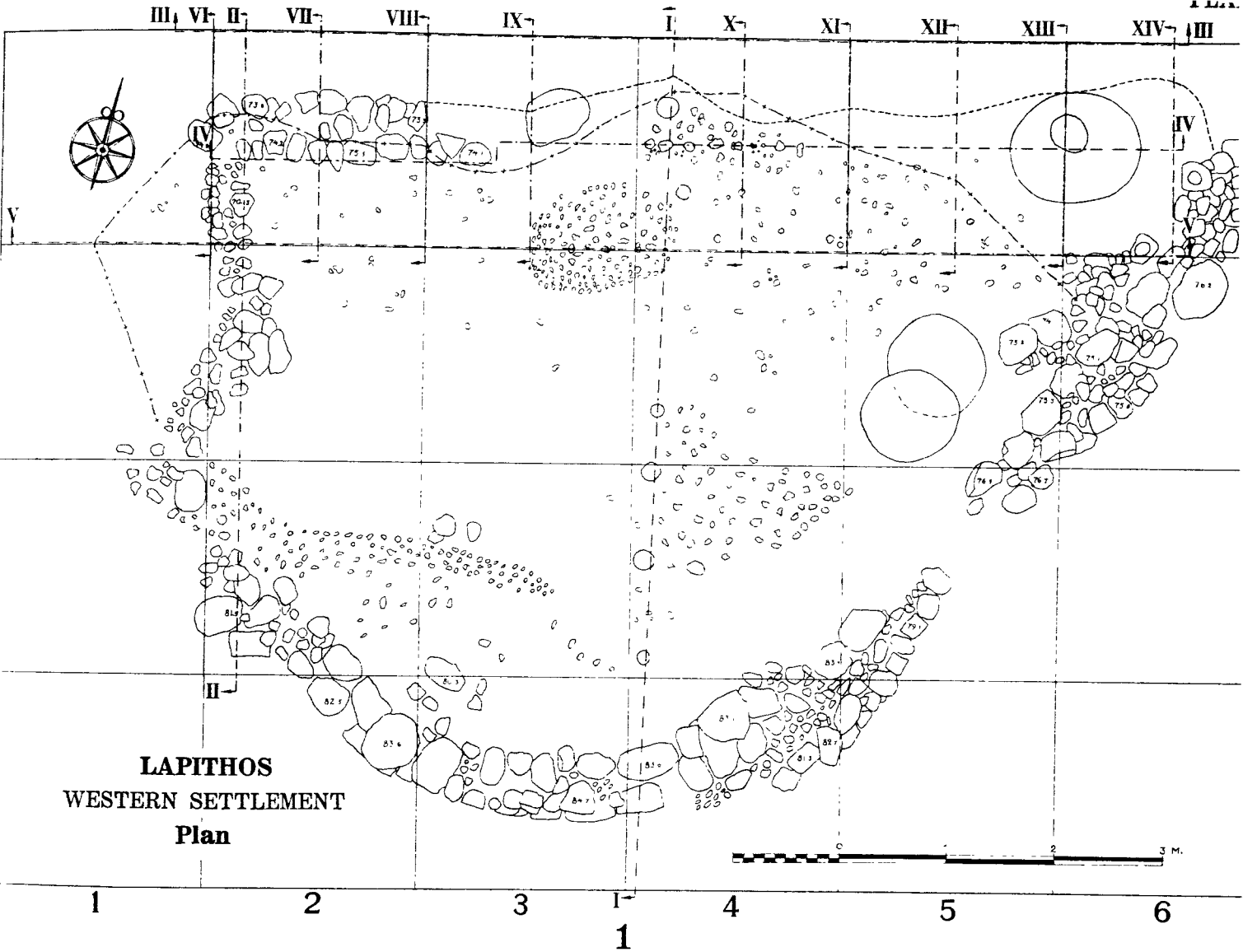

Sections

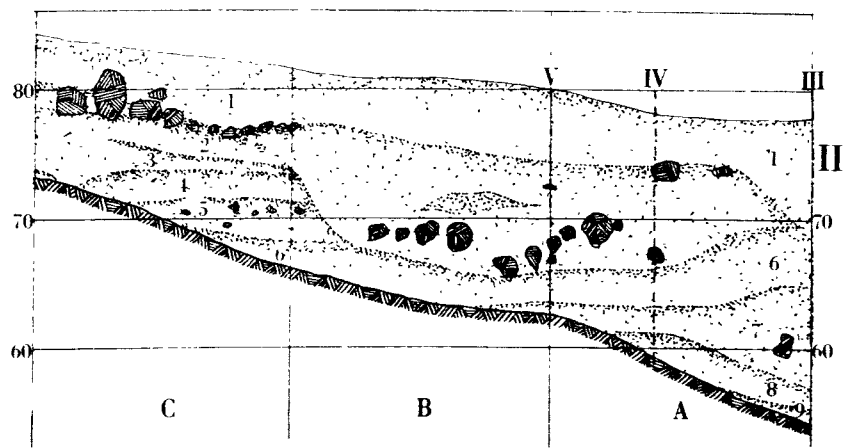
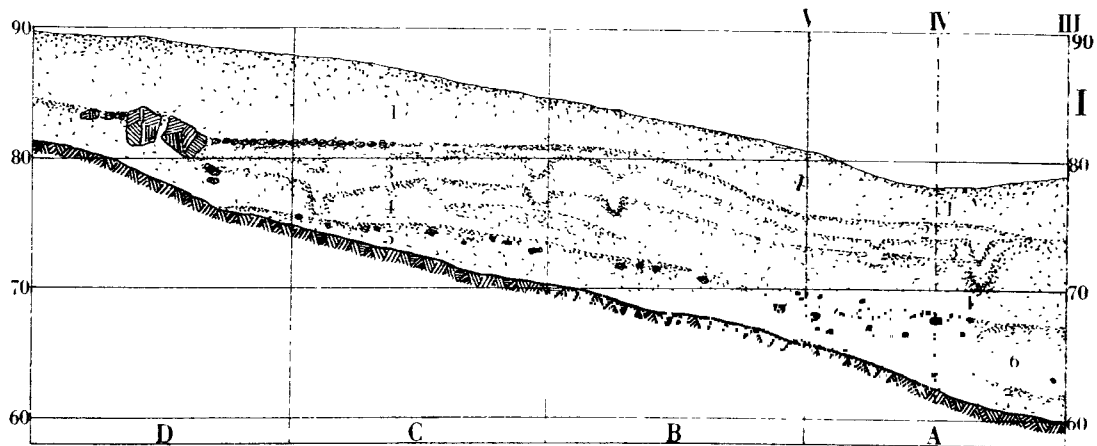

LAPITHOS
WESTERN SETTLEMENT
Sections

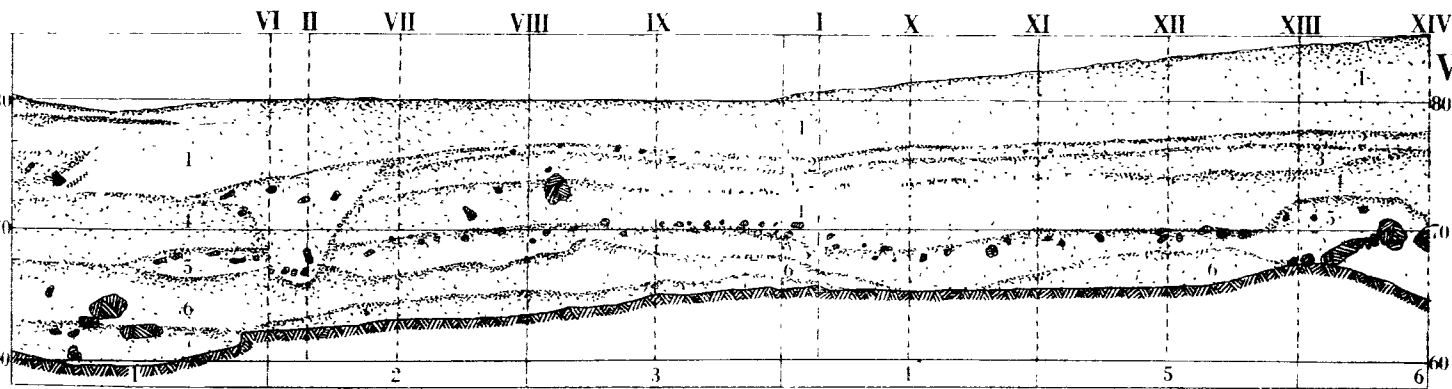
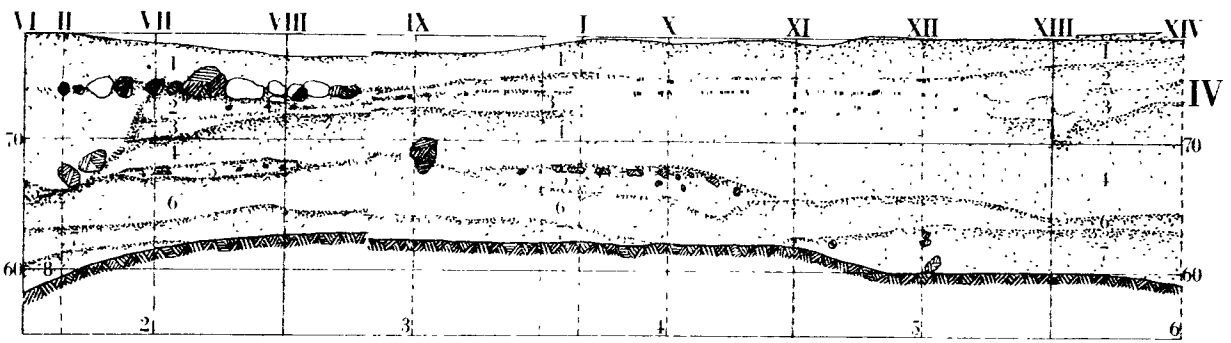

1

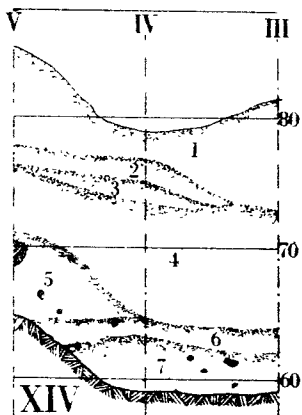
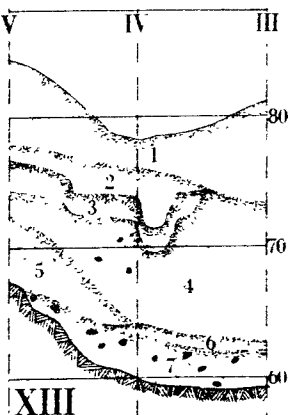
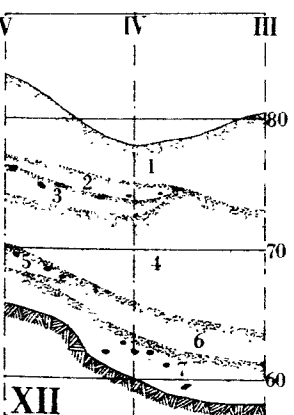
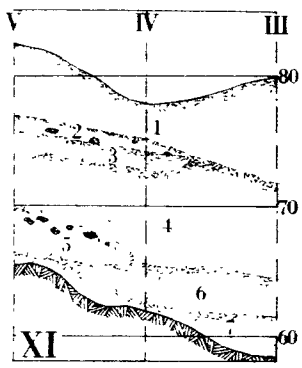
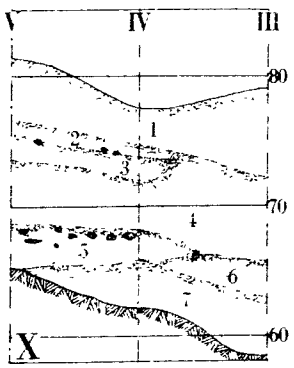
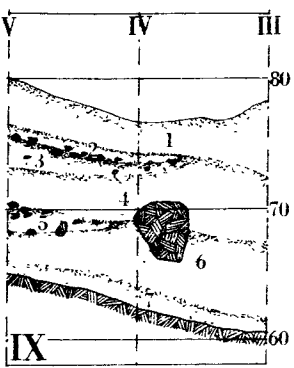
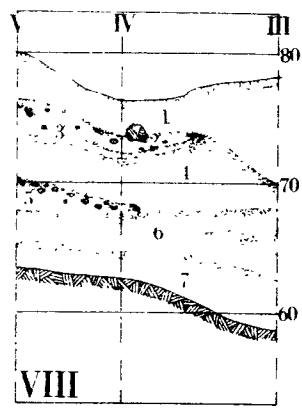
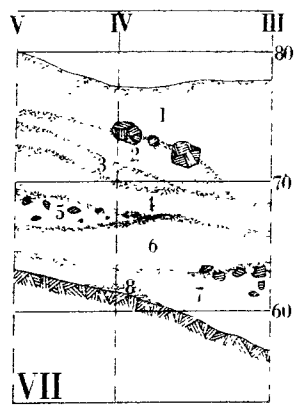
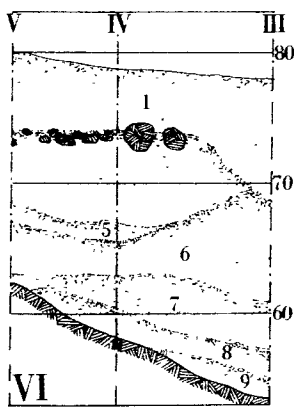

2

The diagram shows that the same marked difference between the two Neolithic periods, which was noted as regards the pottery, holds good also for the non-ceramic products, viz. the flints are very numerous in the earlier period represented by the eastern settlement, but rare in the later period represented by the western settlement. Stone implements (axe-heads), on the other hand, are common in both periods.

ABSOLUTE CHRONOLOGY

As shown in Part IV of this work there are no fixed points for an absolute date of the Cypro-Neolithic period except that it precedes the beginning of the Copper Age. The western settlement, representing the later part of the Neolithic period, would therefore be assigned to the end of the 4th millenium B.C., and the eastern settlement must be earlier, but how much earlier in the 4th millenium B.C., it is impossible to say.

E. G.

The necropolis at Vrysi tou Barba

INTRODUCTION

The necropolis of Vrysi tou Barba is well known to all archæologists who have dealt with Cypriote antiquities. Messrs. Myres and Ohnefalsch-Richter hinted at its existence, when mentioning the principal archaeological sites of the island in the introduction to their Catalogue of the Cyprus Museum.¹ Ohnefalsch-Richter published some terracotta idols, evidently found in tombs from this site²; and, finally, systematic excavations were carried out there by Professor Myres in 1913 and in 1917 by Mr. M. Markides, Keeper of the Cyprus Museum at that time. The results of these excavations are, however, unpublished, with the exception of a short summary of Mr. Markides's diary, and some notes about the burial customs, observed during the 1913 excavation, given by E. Gjerstad³; the latter also mentions the site in his Topography.⁴

The necropolis is situated about three quarters of a mile west of the central portion of the village of Lapithos along the shore and not far from its westernmost gardens. The site is poorly cultivated and consists of a white limestone rock, covered by a thin layer of earth. The rock, which is of a sedimentary character, is called "*chavara*" by the natives (See Introduction to this volume). The ground is a flat plain which slopes gently towards the shore, and is overlooked by the steep mountains of the Kerynia-chain. During the winter, the site is often flooded by watercourses, running down from the mountains, a fact which could be frequently observed during the excavation (cf. below pp. 53 and 108). Close to the shore is the fresh spring, from which the locality derives its name.



Fig. 20. Lapithos. View from the mountains towards the sea.

We began our excavations in the immediate neighbourhood of the field which had been the site of the earlier operations, and in some cases even struck upon tombs already cleared (cf. below pp. 76 and 140). The purpose was to obtain a representative series of tombs from a limited area; and only one tomb was opened in the eastern border of the necropolis (Tomb 322).

In all, twenty-three tombs were excavated during the two months the work was in progress between the end of September and the end of November 1927; and the necropolis was far from being exhausted, when we left.

TOMB 301 (Figs. 22; 24:1—3)

	SIZE			
	Length	Width	Height	Depth
Dromos	2.54	1.63	—	1.34
Stomion A	0.42	0.50	0.44	—

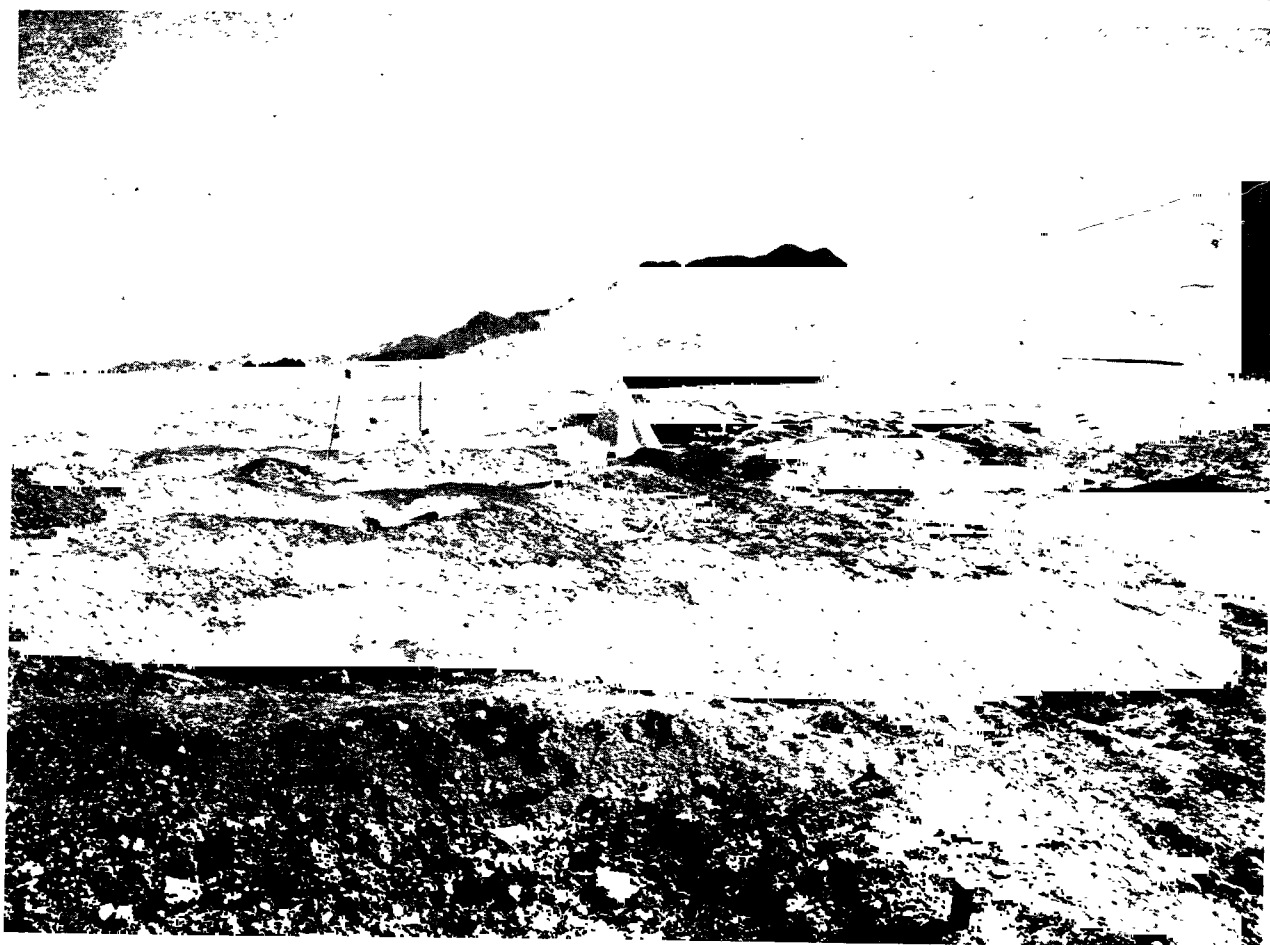

Fig. 21. Vrysi tou Barba. The necropolis during excavation.

Chamber A	1.52	2.20	0.95	—
Stomion B	0.40	0.60	0.39	—
Chamber B	1.53	1.83	0.93	—
Stomion C	0.50	0.52	0.41	—
Chamber C	1.73	2.50	0.98	—

SHAPE

The dromos is bucket-shaped and of comparatively small size. The sides taper downwards, and the floor slopes towards the short, front side. Three chambers open out from the dromos, one on each long side, and one on the short, front side. They are all of similar type, and roughly circular, or oval in shape with horizontal floors, and steeply sloping tunnel-shaped stomia. Walls and roofs are flat vaults. The doors are closed by thin slabs of local limestone kept in position by smaller stones wedged round the sides.



Fig. 22. Lapithos. Tomb 301, dromos.



Fig. 23. Lapithos. Tomb 302, dromos.

STRATIFICATION

The dromos was filled by a homogeneous mass of *chavara* without distinct stratification, but the increasing number of potsherds at the bottom shows that the tomb has been used repeatedly, and partly cleared out between the different burials; a fact which was more fully illustrated by the interior stratigraphical conditions of the chambers.

In Chamber A a layer of debris, 0.30 m. thick, had fallen from roof and walls and covered the find stratum, and had, by its sudden collapse, caused considerable damage to the fragile pottery. An earlier burial, to which the bowls Nos. 3, 5 and 6, and the badly damaged jugs Nos. 10—13 can be assigned, was found in the S. corner of the chamber; evidently thrown into the position in which it was actually found. The N. corner was occupied by another skeleton to whom, apparently the rest of the tomb-gifts belonged.

Chamber B was well preserved, and distinctly stratified in two layers. To the upper layer belonged a skeleton and a single pot (No. 1). The bottom layer, separated from the upper by a stratum of *chavara*, 0.20 m. thick, rested directly on the floor. The E. corner was occupied by a low bench of flat, irregular stones on which a body had evidently been placed. To this burial period the rest of the pottery, Nos. 2—8, and the bronzes must be assigned.

In Chamber C the find layer was covered only by a thin stratum of debris; the chamber contained only one burial.

BURIALS

The later burial in Chamber A was in a very bad state of preservation, and no conclusions, with regard to the original position of the dead body, could be drawn. In Chamber

B however, the skeleton, belonging to the upper layer, had been placed lying on the right side, in a slightly contracted position. An analysis of the skeletal remains of the lower layer shows that one of the dead bodies must have been deposited in a squatting position with his back against the wall of the chamber; but the remains of the second skeleton were too fragmentary to allow of any certain conclusions being drawn with regards to its original position. The following remarks can be made on the burial methods used in Chamber C: in the centre of the chamber were found the remains of a corpse, which had originally been placed, sitting with the arms clasped round the knees, and facing south. The pelvis and some vertebrae had fallen backwards and were found in a dorsal position, but the position of the femur and fragments of the humerus gave conclusive evidence as regards the original position. It is worth mentioning that Chamber A and Chamber B seemed to contain only female skeletons, and that the only male skeleton of the tomb was found in Chamber C.

FINDS (GROUPS: PL. XIV, 1, 2; TYPES: L. OF PL. II)

Chamber A

1. Red Polished III globular jug with wide, cylindrical neck, splaying rim, and handle from neck to shoulder. Height 40.0. Floor.
2. Red Polished III jug as No. 1. Height 24.0. Floor.
3. Red Polished I deep, hemispherical bowl with a small, double projection below rim. Even red surface. Diam. 11.0. Floor.
4. Red Polished II hemispherical bowl with a string-hole projection at the rim. Black inside and rim. Diam. 12.2. Floor.
5. Red Polished I bowl as No. 3. Diam. 12.0. Floor.
6. Red Polished II bowl as No. 4. Diam. 12.0. Floor.
7. Red Polished II globular cooking-pot with splaying rim, and two handles from rim to body. Coarse surface. Height 29.0. Floor.
8. Spindle-whirl of Red Polished Ware. Diam. 4.5. Floor.
9. Red Polished II cooking-pot as No. 7. Not complete. Height 21.0. Floor.
10. Red Polished I globular jug with concave, cut-away neck, splaying rim, and an incised handle from neck to shoulder. Height 43.3. Floor.
11. Red Polished I jug as No. 10. Not complete. Height 15.9. Floor.
12. Red Polished I ovoid jug with round base; wide, tapering neck, splaying rim, and handle from rim to shoulder. Height 24.1. Floor.
13. Fragment of a Red Polished II jug with a handle from rim to shoulder, and a small string-hole projection opposite the handle. Body covered with vertical bands of parallel zigzag lines, chevrons and horizontal lines. Rim and half of body missing. Height c. 12.0. Floor.
2. Red Polished II hemispherical bowl with a horizontal string-hole projection at rim. Diam. 11.1. Floor.
3. Fragments of a Red Polished II globular amphora. Floor.
4. Red Polished II bowl as No. 2. Diam. 12.2. Floor.
5. Red Polished I deep bowl with round base, and a projection at the rim. Black rim and inside. Diam. 10.8. Floor.
- 6—8. Fragments of three Red Polished II jugs. Floor.

Chamber C

1. Red Polished II hemispherical bowl with a string-hole projection at rim. Black rim and inside. Diam. 14.8. Floor.
2. Red Polished II bowl as No. 1. Diam. 16.6. Floor.
3. Bronze sword with straight sides, two edges, pointed end, high midrib, deep grooves at root of tang, and hooked, solid, bent tang. Length 63.6. Floor.
4. Bronze tweezer with rounded top. Length 9.7. Floor.
5. Bronze scraper with concave sides, straight end, and flat, tapering tang pierced by a rivet-hole. Length 12.1. Floor.
6. Leaf-shaped bronze knife with straight sides, two edges, round end, low midrib, and short, narrow, flat tang with three rivet-holes. Length 13.5. Floor.
7. Bronze knife as No. 6, but with concave sides. Length 11.3. Floor.
8. Fragment of a large Red Polished II jug. Floor.
9. Red Polished II bowl as No. 1. Damaged. Floor.
10. Red Polished II bowl as No. 1. Damaged. Floor.
11. Red Polished II jug with round base, tapering neck, and handle from rim to shoulder. Damaged. Height 15.5. Floor.
12. Fragments of a Black Polished, incised flask with flat base. Floor.
13. Bronze sword as No. 3. Length 46.9. Floor.
14. Bronze tweezer with loop-shaped top. Length 12.0. Floor.
15. Flat bronze knife with straight sides, two edges, and tapering top. End missing. Length 15.0. Floor.

Chamber B

1. Red Polished II globular jug with round base; concave, cut-away neck; splaying rim, and handle from neck to shoulder. Height 31.0. Floor.

Summing up the descriptions given in the Object Register and the observations of the distribution of the finds in the stratification, we obtain the following diagram.

	P o t t e r y				B r o n z e				Terrac Spind e- wirls
	R P I	R. P. II	R P III	Bl Pol	Knives	Scraper	Swords	Tweezers	
Chamber A 1st burial	3, 5, 10 11, 12 -5	6, 13 -2							
Chamber A 2nd burial		4, 7, 9 -3	1, 2 -2						8 -1
Chamber B 1st burial	5 -1	2, 3, 4 6, 7, 8 -6							
Chamber B 2nd burial		1 -1							
Chamber C		1, 2, 8 9, 10, 11 -6		12 -1	6, 7, 15 -3	5 -1	3, 13 -2	4, 14 -2	

CHRONOLOGY

The diagram shows, that the tomb was built in the beginning of the E. C. II period, and that the first two burials which took place in Chamber A and Chamber B, are the oldest interments in the tomb. In the bottom stratum of Chamber A the majority of the pottery is still Red Polished I Ware though of late types and among the tomb gifts, belonging to the first burial in Chamber B, we still find a single Red Polished I pot. Later, in the E. C. II period, Chamber B was reused, and Chamber C used for the first time. The two jugs of the Red Polished III class in Chamber A show, that this chamber was again used, after a considerable lapse of time, in the very beginning of the E. C. III period.

TOMB 302 (Figs. 22; 24:5—7; 25; 27)

	SIZE			
	Length	Width	Height	Depth
Dromos	2.06	1.24	—	1.07
Stomion A	0.80	0.88	0.46	—
Chamber A	2.96	3.31	1.30	—
Stomion B	0.71	0.81	0.55	—
Chamber B	2.26	3.85	1.49	—
Stomion C	0.48	0.70	0.55	—
Chamber C	1.83	2.60	0.99	—

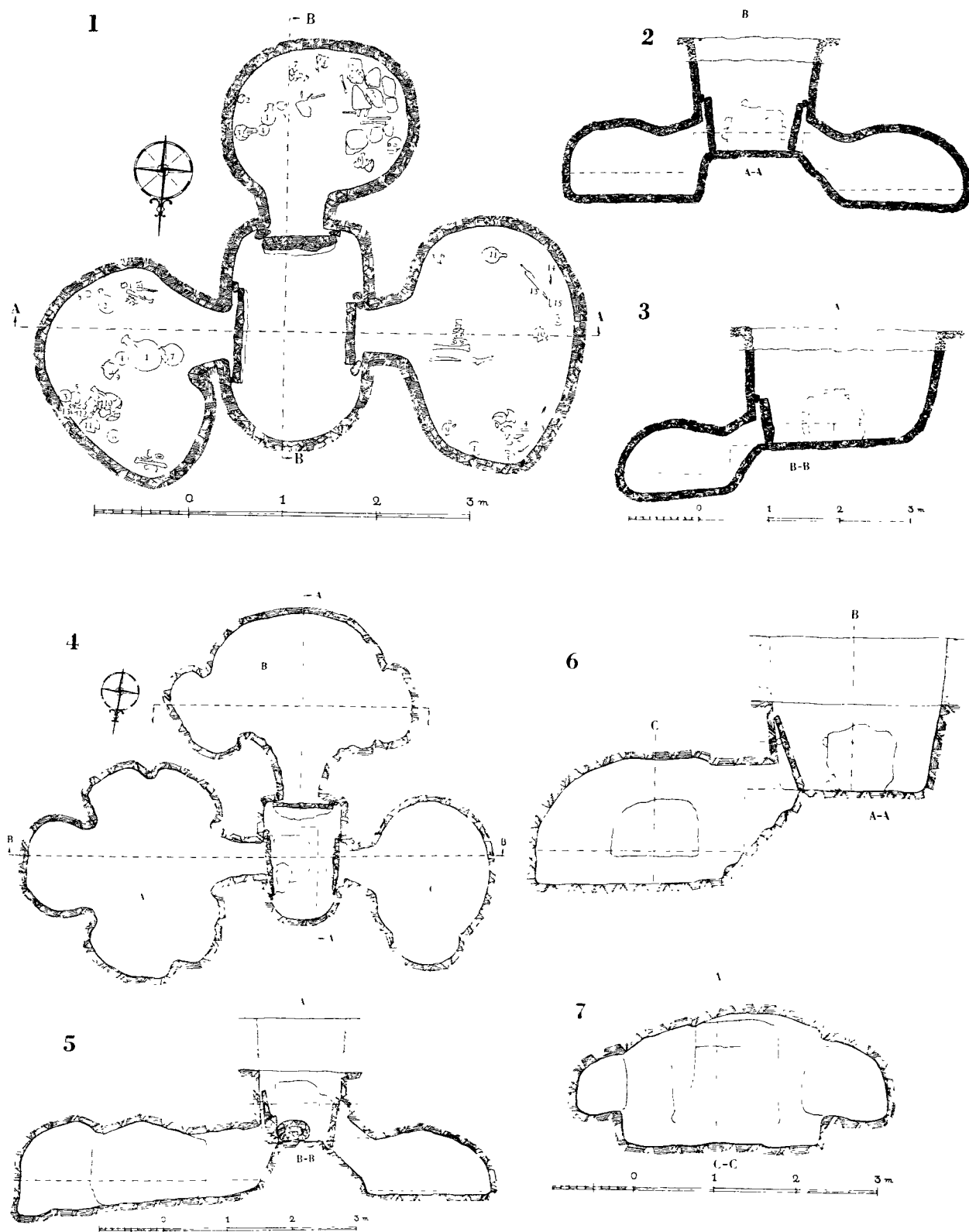

Fig. 24. Lapithos. Tomb 301, Plan (1); Sections A—A, B—B (2, 3). Tomb 302, Plan (4); Sections A—A, B—B, C—C (5, 6, 7).

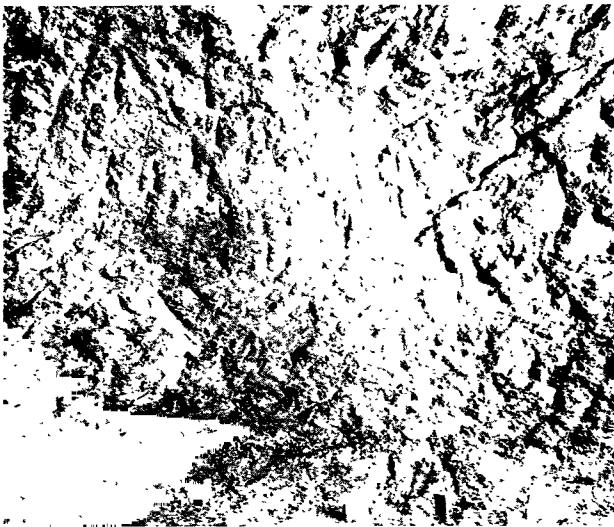

Fig. 25. Lapithos. Tomb 302 A. Traces of the cutter's tool.



Fig. 26. Lapithos. Tomb 303, dromos.

SHAPE

The structure of this tomb very much resembles that of Tomb 301. The dromos is of the same characteristic shape, with two roughly parallel long sides, a straight front, and an apsidal back. The tomb has three chambers, all blocked with single, thin slabs, wedged with smaller stones, and provided with widening stomia sloping down. The plan of Chamber A is almost symmetrical and very elaborate: it is cut out with a series of niches along the sides. Two shallow recesses flank the door, a pair, somewhat deeper, follow further in, and a large, more than semicircular niche, was hollowed out opposite the entrance. The spaces between the niches produce the effect of columns, preventing the wide and low central vault from falling in. The desired effect was obtained, and practically no debris had fallen from roof or walls.

Chamber B also, which opens from the front of the dromos, is of a roughly symmetrical shape. The plan is oval, with two deep niches in the short sides. The niches are cut about 0.40 m. above the floor, and their edges are raised forming a low lip. The floor of the chamber slopes slightly towards the back wall, and the deepest parts of the niches are equally to be found near the walls.

Behind the door stone of Chamber C was a rectangular cutting, framing the entrance, but it had only a decorative purpose. The chamber itself, the smallest of the series, has a plain, oval plan and a small niche at the level of the floor, on the S. side.

STRATIFICATION

The *chavara* filling of the dromos was homogeneous, and contained only a few potsherds of the Red Polished II class, which seems to be proof that the dromos has been entirely cleared out for every new burial. In Chamber A all the finds were lying on the floor, and

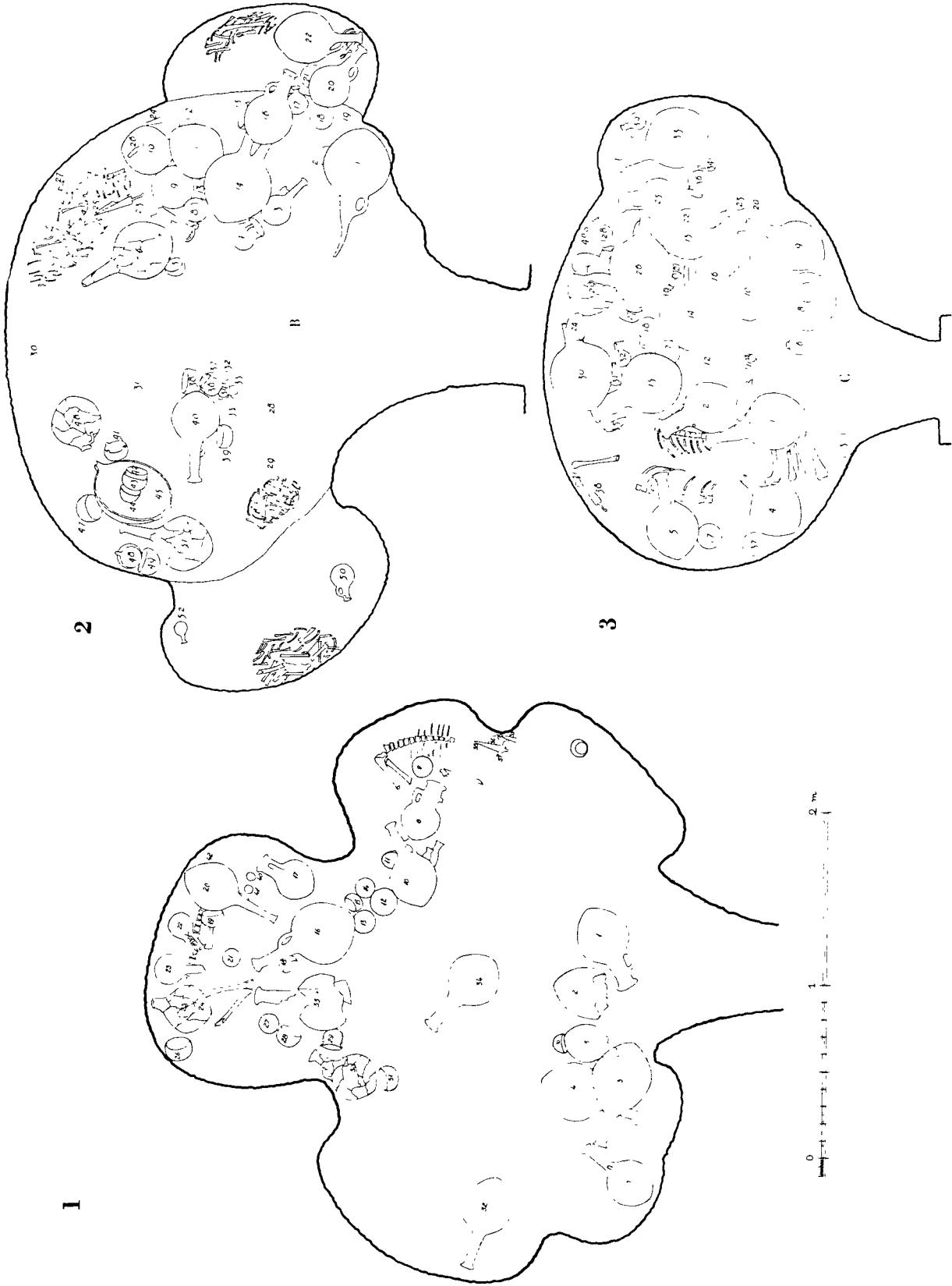

Fig. 27. Lapithos. Tomb 302 A (1); Tomb 302 B (2); Tomb 302 C (3), Finds *in situ*.

the construction of the tomb has prevented any debris from falling on the find stratum. Consequently, skeletons and finds lay practically bare, when the tomb was opened. Chambers B and C are characterized by the same simple stratification, but in Chamber B a part of the roof has collapsed, and caused considerable damage to the contents of the tomb. This lack of stratigraphical evidence makes the distribution of the finds between the different burials difficult and uncertain, and, as a matter of fact, it is unlikely that any considerable length of time elapsed between them.

The finds of Chamber A were found arranged in three groups; one in front of the door, another, about a skeleton in the back niche, and a third close to a skeleton in one of the shallow niches, to the right. It can *a priori* be presumed, that the second group is older than the first, and that the first group is later than the third, but the relation between the second and the third, cannot be fixed. Conclusions of the same limited value can be drawn from the burial conditions in Chamber B. Four bodies were found, two in the niches, and two below the niches on the floor. The former could not conveniently have been placed in their positions, when the floor was already occupied by the latter, and it is therefore reasonable to suppose that they are older. The finds Nos. 20, 21, 22, 50 and 52 have to be assigned to this, presumed, earlier period, but, of course, there is no evidence that some of the other objects found on the floor, do not also belong to the same period. In Chamber C only two burials had taken place, both on the floor; and it is impossible to decide which of the two was buried first, as all the objects were found on the floor. To this rule there is only one exception; in the spindle-whirl No. 41, which rested on a small heap of black, carbonized matter, possibly, the remains of a quantity of wool.

BURIALS

Of the skeletons in Chamber A, only the two in the niches were preserved; both had been placed in slightly contracted, lateral positions. The body in the central niche was female, and surrounded by much pottery; two spindle-whirls close to the head indicate the sex. The skeleton in the side niche was male, and had his hands under his head, grasping two knives, one scraper and a pair of tweezers. The state of preservation of the skeletal material in the central chamber was too bad to permit of any conclusions, as regards their original positions. The long, low shape of the niches seem, however, to make the sitting position impossible. The skeletons on the floor were both male, and the bodies in the niches, female. In Chamber C both skeletons were lying on their right sides, in a slightly contracted position.

FINDS (GROUPS: PLS. XV—XVII; TYPES: L. OF PL. II)

C h a m b e r A

1. Red Polished II globular jug with short, cylindrical neck, splaying rim, topped, rounded base and handle from neck to shoulder. Height 52.0. Floor.
2. Red Polished II globular jug mainly as No. 1. The neck, which evidently has been tall and narrow, is missing. Surface damaged. Height 44.3. Floor.
3. Red Polished II globular jug with round base; tall, cylindrical neck, flattened rim, and a knobbed handle from neck to shoulder. Pinched lines in relief on neck, and between neck and shoulder. Height 62.5. Floor.
4. Red Polished II jug mainly as No. 3, but with narrowing neck and plain handle. Height 61.3. Floor.
5. Red Polished II ovoid jug with rounded base, and

- handle from neck to shoulder. Pinched lines in relief on shoulders. Neck and handle missing. Height c. 32.2. Floor.
6. Red Polished II hemispherical bowl with a string-hole projection at rim. The decoration consists of a framed band of oblique groups of parallel lines below rim, and concentric circles between vertical bands of horizontal lines on body. Black rim and inside. Diam. 11.2. Floor.
 7. Red Polished II globular jug with tall, somewhat narrowing neck, splaying rim, handle from neck to shoulder, and a projection opposite the handle. Height 48.0. Floor.
 8. Red Polished II globular amphora with wide, tapering neck; small, splaying rim, and two flat, angular handles from neck to shoulder. Decorated with incrustated incisions in horizontal bands of parallel lines around neck, shoulder and belly; two friezes of squares, alternating with concentric semicircles around body, and zigzag lines on handles. Height 37.2. Floor.
 9. Red Polished II bowl as No. 6. Horizontal lines below rim; body covered with a broad frieze of lattice-lozenges. Black rim and inside. Chipped. Diam. 12.0. Floor.
 10. Red Polished II globular jug with round base; tall, tapering neck, splaying rim, and a knobbed handle from neck to body. Pinched lines in relief around neck and shoulder. Height 52.5. Floor.
 11. Red Polished III bowl mainly as No. 6. The decoration consists of two framed zigzag bands around body. Even red surface. Diam. 10.2. Floor.
 12. Red Polished II bowl as No. 6. Black rim and inside. Diam. 16.5. Floor.
 13. Red Polished II bowl as No. 12, but somewhat deeper. Diam. 13.7. Floor.
 14. Red Polished II bowl as No. 12. Rim missing. Diam. 11.8. Floor.
 15. Red Polished II bowl as No. 13. Diam. 10.5. Floor.
 16. Red Polished II globular jug with round base, cylindrical neck, splaying rim, and handle from neck to shoulder. Pinched lines in relief around neck and shoulder. Height 66.0. Floor.
 17. Red Polished II globular amphora with cylindrical, somewhat concave neck, splaying rim, and two flat, angular handles from neck to shoulder. Height 35.4. Floor.
 18. Red Polished II bowl as No. 12. Diam. 9.8. Floor.
 19. Red Polished II bowl as No. 12, and decorated with an incised pattern, consisting of a framed band of oblique, parallel lines below rim, and vertical lattice-bands, alternating with framed, parallel zigzag elements around body. Diam. 12.3. Floor.
 20. Red Polished II globular jug with round base; tall, almost cylindrical neck; splaying, flat rim, a knobbed handle from neck to shoulder, and a horizontally pierced projection opposite the handle. Pinched, vertical incised, zigzag lines on shoulder. Height 59.0. Floor.
 21. Red Polished II bowl as No. 12. Diam. 10.2. Floor.
 22. Red Polished II globular jug with two cylindrical necks, funnel-rims, and a fork-handle from necks to shoulder, and an incised idol-shaped projection on shoulder. Three bands of parallel lines around each neck, and a skeuomorphic pattern of concentric circles, obliquely and horizontally connected by broad bands of parallel lines all over the body. In the interstices are parallel zigzags and framed, hatched, vertical lines. Height 25.4. Floor.
 23. Red Polished III globular jug with round base, backwards-curved, tubular neck adorned with knobs, beaked mouth, and handle from rim to shoulder. Short, vertical lines in relief from neck to shoulder. Height 32.5. Floor.
 24. Red Polished II globular jug with round base; tall, tapering neck, splaying rim, and handle from neck to shoulder. Much damaged. Floor.
 25. Red Polished II bowl as No. 12. Diam. 10.3. Found below No. 24.
 26. Red Polished II bowl as No. 13. Diam. 14.2. Floor.
 27. Red Polished III hemispherical bowl with four hooked projections, one of which pierced by two vertical holes, on rim. The pot has even red surface, and is decorated with incised patterns consisting of parallel lines around rim, vertical groups of herringbone patterns, parallel zigzags, straight lines from rim to base. Diam. 10.3. Floor.
 28. Red Polished II bowl as No. 13. Diam. 13.2. Floor.
 29. Red Polished II globular cooking-pot with round base, slightly marked rim, and two handles from rim to body. Coarse surface. Height 11.8. Floor.
 30. Few fragments of a large Red Polished II jug. Floor.
 31. Red Polished II bowl as No. 13. Diam. 13.0. Floor.
 32. Red Polished II globular jug with round base; tall, tapering neck, splaying rim, and handle from neck to shoulder. Pinched lines in relief around neck and shoulder. Height 55.0. Floor.
 33. Fragments of a Red Polished II jug as No. 32, but with knobbed handle. Floor.
 34. Red Polished II jug as No. 32, but without any decoration. Height 53.1. Floor.
 35. Bronze tweezer with loop-shaped top. Length 10.0. Floor.
 36. Broad, rectangular bronze scraper, with two edges, low midrib, and flat, narrow tang with one rivet-hole. Length 8.7. Floor.
 37. Leaf-shaped bronze knife with concave sides, pointed end, two edges, low midrib, and flat, tapering tang with three rivet-holes. Length 11.9. Floor.
 38. Bronze dagger with convex sides, pointed end, high midrib, two edges, and a hooked, solid tang. Length 25.2. Floor.
 39. Red Polished III almost conical bowl with round base, and inwards-turned rim. Surface badly worn. Not complete. Diam. 12.1. Floor.
 40. Incised Red Polished conical spindle-whirl. Diam. 4.5. Floor.
 41. Incised Red Polished conical spindle-whirl. Diam. 3.8. Floor.
 42. Red Polished II pear-shaped jug with round base. The body is decorated with concentric circles connected with bands of oblique and horizontal lines. Neck and handle missing. Height 10.0. Floor.

C h a m b e r B

1. Red Polished II globular jug with round base, short, backwards-curved neck; high, beaked spout, twisted handle from rim to shoulder, and a string-hole projection opposite the handle. Snake- and string-ornaments on neck and shoulder. Height 75.5. Floor.
2. Red Polished II hemispherical bowl with a string-hole projection at rim. Black rim and inside. A band of parallel zigzag lines below rim, and groups of vertical lines and chevrons on body. Diam. 12.0. Floor.
3. Red Polished II globular jug with round base; tall, tapering neck, wide funnel-rim, a knobbed handle from neck to shoulder, and a string-hole projection opposite the handle. Three groups of horizontal lines around neck, joined by narrow, vertical bands, composed of short horizontal elements. A framed zigzag frieze around shoulder, and a framed frieze of hatched lozenges below belly. Height 34.0. Floor.
4. Red Polished II globular cooking-pot with round base; wide, cylindrical neck; slightly splaying rim, and one large elevated and one small handle from rim to shoulder. Height 18.5. Floor.
5. Red Polished II hemispherical bowl with a string-hole projection near the rim. Diam. 11.0. Floor.
6. Fragments of a Red Polished II globular jug with tall, cylindrical neck, handle from neck to shoulder, and a decoration of pinched relief-lines. Floor.
7. White Painted I cult vessel. An upright plank-shaped central handle with two horn-shaped projections and a hole at the top, surrounded at the base by four shallow bowls with round bases. Four horizontal network friezes on handle; bowls outside covered with network-designs. Bowls damaged and partly missing; one projection missing. Height 26.8. Floor.
8. Red Polished II cooking-pot with round base, and two handles from rim to shoulder. Diam. 12.0. Floor.
9. Red Polished II globular amphora with round base; wide, cylindrical neck, splaying rim, two knobbed handles from rim to shoulder, and two string-hole projections between the handles. Rim chipped. Height 34.9. Floor.
10. Red Polished II globular jug with slightly pointed base; wide, convex neck; splaying rim, and handle from neck to shoulder. Height 48.0. Floor.
11. Red Polished II large jug as No. 10, but with tall, tapering neck, and a small projection opposite the handle. Ornament of pinched lines on neck. Height 56.0. Floor.
12. Red Polished II bowl as No. 5. Diam. 10.5. Floor.
13. Red Polished II bowl as No. 5. Rim chipped. Diam. 14.5. Floor.
14. Red Polished II large globular jug with slightly pointed base, two tall, cylindrical necks, splaying rims, and one fork-handle from necks to shoulder. Ornaments of pinched lines on the necks. Height 70.0. Floor.
15. Red Polished II bowl as No. 5. Rim chipped. Diam. 15.0. Floor.
16. Red Polished II large jug as No. 10. Rim chipped. Height 46.0. Floor.
17. Red Polished II pear-shaped jug with round base; short, cylindrical neck, wide funnel-rim, handle from rim to shoulder, and a projection on shoulder opposite the handle. Encircling lines around neck; body covered with a skeuomorphic design of concentric circles, connected by straight, parallel lines. Height 15.0. Floor.
18. Red Polished II bowl as No. 5. Diam. 13.0. Floor.
19. Red Polished II large jug, fragmentary. Floor.
20. Red Polished II ovoid jug with slightly pointed base; tall, tapering neck; splaying rim, and handle from neck to shoulder. Ornaments of pinched lines on shoulder. Height 45.0. Floor.
21. Red Polished II bowl as No. 5. Diam. 13.0. Floor.
22. Red Polished II large jug as No. 10, but with tall, tapering neck. Rim chipped. Height 51.0. Floor.
23. Bronze dagger with straight sides, pointed end, two edges, midrib, heart-shaped shoulders, and tapering, hooked, solid tang. Traces of leather-strips and wood on tang. Length 30.6. Floor.
24. Whetstone of lamellar stone with tapering top, pierced by a hole. Length 9.3. Floor.
25. Bronze knife with slightly concave sides, rounded end, two edges, low midrib, and flat tang with one rivet at top. Length 15.5. Floor.
26. Bronze tweezer with narrow arms, and loop-shaped top. Traces of leather-windings round the arms. Length 12.9. Floor.
27. Wedge-shaped bronze axe with rounded edge and pointed end. Length 5.9. Floor.
28. Red Polished II large jug; fragmentary. Floor.
29. Red Polished II jug as No. 28; fragmentary. Floor.
30. Red Polished II jug as No. 28; fragmentary. Floor.
31. Red Polished II crater-shaped, deep bowl with flattened base, splaying rim, and upwards-turned, tubular spout, supported by a handle; a knobbed handle from neck to shoulder. Much repaired. Height 31.2. Floor.
32. Red Polished III globular, miniature jug with very short neck; small, wide beaked mouth, and handle from rim to shoulder. Chipped and damaged. Height 8.5. Floor.
33. Bronze scraper with concave sides, flat end, rounded shoulders, low midrib, two edges, and flat tang with one rivet at top. Length 12.2. Floor.
34. Flat, roughly circular whetstone with one smooth side. Diam. 10.2. Floor.
35. Trapezoid whetstone with one smooth side. Traces of fire at one end. Heavy, volcanic stone. Length 12.5. Floor.
36. Red Polished II cooking-pot as No. 4, but with very short neck, one handle, and a knob opposite the handle. Height 12.5. Found inside No. 37.
37. Red Polished II bowl as No. 5. Diam. 14.5. Floor.
38. Red Polished II deep, hemispherical bowl with a string-hole projection at rim. Diam. 15.0. Floor.
39. Red Polished II bowl as No. 5. Diam. 11.0. Floor.
40. Red Polished II large jug as No. 10, but with tall, cylindrical neck, and ornaments of pinched lines on neck and shoulder. Height 52.0. Floor.

41. Red Polished III hemispherical bowl with four projections on rim, one of which is pierced. Even red. A conventionalized bough design around rim, and two friezes of hatched lozenges covering body. Diam. 12.2. Floor.
42. Red Polished III hemispherical bowl with a string-hole projection on rim. Black inside and rim. Horizontal lines below rim, and a skeuomorphic design of concentric circles, joined by parallel lines covering body. Diam. 13.0. Found inside No. 43.
43. Red Polished II bowl as No. 38. Diam. 13.2. Found inside No. 44.
44. Red Polished II bowl as No. 38. Diam. 12.0. Found inside No. 45.
45. Red Polished II wide bowl with flat base, a horizontal projection on rim, pierced by two vertical string-holes, and an outlet opposite the projection. Diam. 44.8. Floor.
46. Red Polished II jug; fragmentary. Floor.
47. Red Polished II bowl as No. 5. Diam. 15.0. Floor.
48. Red Polished II cooking-pot as No. 36. Height 15.5. Floor.
49. Red Polished II bowl as No. 5. Diam. 14.8. Floor.
50. Red Polished II globular jug with round base, cylindrical cut-away neck, splaying rim, and handle from neck to shoulder. Much restored. Height 20.5. Floor.
51. Red Polished II large jug; fragmentary. Floor.
52. Black Polished globular bottle with round base; tall, narrow neck, and flattened rim. Horizontal bands of parallel lines around neck; body covered with a skeuomorphic design of concentric circles, connected by parallel lines. Height 12.5. Floor.
11. Red Polished II pear-shaped jug with round base, tapering neck, funnel-rim, and handle from rim to shoulder. Parallel lines around neck, and a staircase-pattern covering body. Height 13.5. Floor.
12. Red Polished II globular jug similar to No. 1, but with plain handle. Rim missing. Found in pieces. Height 60.2. Floor.
13. Red Polished II jug as No. 1. Upper part of neck missing. Height 44.5. Floor.
14. Red Polished II jug as No. 1. Rim missing. Height 58.7. Floor.
15. Red Polished III globular jug with round base; cylindrical, cut-away neck; splaying rim, and a knobbed handle from neck to shoulder. A rich decoration in relief consisting of pinched and wavy lines around neck, shoulder and handle. Height 56.0. Floor.
16. Fragments of a deep, Red Polished II, cooking-pot. Floor.
17. Red Polished II bowl as No. 3. Rim chipped. Diam. 15.0. Floor.
18. Red Polished III pear-shaped jug with round base; tall, cylindrical, cut-away neck, funnel-rim, and handle from neck to shoulder. Height 21.7. Floor.
19. Red Polished II hemispherical bowl as No. 3. Two framed friezes of hatched lozenges around body. Diam. 10.0. Floor.
20. Red Polished III globular jug with round base, cylindrical neck, splaying rim, and handle from neck to shoulder. Surface much worn. Found in pieces. Height 35.8. Floor.
21. Red Polished II pearshaped jug with round base, narrow neck, wide funnel-rim, and handle from rim to shoulder. An incised decoration of the skeuomorphic type, similar to No. 6, but enriched with chevrons and vertical lines, composed of horizontal elements. Height 12.1. Floor.
22. Red Polished II bowl as No. 3. Diam. 12.5. Floor.
23. Red Polished II bowl as No. 3, but decorated with an incised pattern of parallel lines around rim, vertical zigzag bands from rim to base, and groups of horizontal, short lines in their interstices. Diam. 9.5. Floor.
24. Red Polished II bowl as No. 3. Diam. 14.5. Floor.
25. Red Polished II globular amphora with round base; cylindrical neck, splaying rim, and two knobbed handles from neck to body. Height 35.0. Floor.
26. Red Polished II globular jug similar to No. 1. Height 61.2. Floor.
27. Red Polished II bowl as No. 3. Diam. 13.5. Floor.
28. Red Polished III pear-shaped jug with round base, tapering cut-away neck, funnel-rim, and handle from rim to shoulder. Height 15.0. Floor.
29. Fragments of a Red Polished II jug. Floor.
30. Red Polished II ovoid jug with slightly pointed base; tapering, tall neck, and handle from neck to shoulder. Upper part of neck missing. Height 52.5. Floor.
31. Red Polished II jug as No. 21, but decorated with incised, horizontal lines around neck, and large concentric semicircles; hatched, framed, vertical bands, and parallel zigzag lines on body. Height 14.0. Floor.
32. Red Polished II jug similar to No. 31. Body decorated with hatched, framed, vertical bands and horizontal zigzag lines. Height 15.0. Floor.

C h a m b e r C

1. Red Polished II globular jug with round base; tapering, tall neck, flaring rim, and a knobbed handle from neck to shoulder. Pinched lines in relief around neck and shoulder, and circular, flat knobs on shoulder. Height 59.0. Floor.
2. Red Polished II globular amphora with round base; wide, convex neck; sharply splaying rim, and two knobbed handles from neck to shoulder. Height 48.5. Floor.
3. Red Polished II hemispherical bowl with round base, and a string-hole projection at rim. Diam. 14.0. Floor.
4. Red Polished II globular jug with round base; tall, tapering neck; splaying rim, and a knobbed handle from neck to shoulder. Half of body missing. Height 58.3. Floor.
5. Red Polished II jug as No. 4, but with plain handle, and button-ornaments in relief on shoulder. Height 52.5. Floor.
6. Red Polished II pear-shaped jug with round base, short neck, funnel-rim, handle from rim to shoulder, and a flat, pointed projection opposite the handle. Body covered with an incised skeuomorphic pattern of concentric circles, connected by bands of parallel lines. Height 14.5. Floor.
7. Red Polished II bowl as No. 3. Diam. 15.0. Floor.
8. Red Polished III globular jug with round base, cylindrical neck, splaying rim, and a handle from neck to shoulder. Height 53.2. Floor.
9. Red Polished II globular jug, similar to No. 1. Rim missing. Height 54.2. Floor.
10. Red Polished II jug as No. 1. Height 52.0. Floor.

33. Red Polished II jug similar to No. 30, but with slightly convex neck and splaying rim. Height 59.8. Floor.
34. Red Polished II jug with globular body, tapering neck and flaring rim. Height 11.0. Floor.
35. Red Polished II bowl as No. 3. Diam. 14.1. Floor.
36. Red Polished II deep cooking-pot with round base, outwards-turned rim, one elevated large handle, and one small handle from rim to body. Coarse surface. Height 14.3. Floor.
37. Red Polished II bowl as No. 3. Diam. 15.1. Floor.
38. Bronze dagger with straight sides, two edges, pointed end, narrow cuttings near the tang, and hooked solid tang. Length 25.9. Floor.
39. Red Polished III pear-shaped jug with round base, tapering neck, splaying rim, handle from neck to shoulder, and a tubular spout opposite the handle. Height 14.5. Floor.
40. Circular broad earring of bronze with a small hooked end. Diam. 1.7. Floor.
41. Black Polished conical spindle-whirl with incisions. Diam. 4.6. Floor.

The diagram below shows the distribution of the different wares in the three chambers:

	P o t t e r y				B r o n z e						Stone	Terrac.
	R. P. II	R. P. III	Wh. P. I.	Bl. P.	Knives	Daggers	Scrapers	Tweezers	Axes	Rings	Whet-stones	Sp.-wh.
Chamber A	1, 2, 3, 4, 5 6, 7, 8, 9, 10 12, 13, 14, 15, 16 17, 18, 19, 20, 21 22, 24, 25, 26, 28 29, 30, 31, 32, 33 34, 42 -32	11, 23, 27 39 -4			37 -1	38 -1	36 -1	35 -1				40 41 -2
Chamber B	1, 2, 3, 4, 5 6, 8, 9, 10, 11 12, 13, 14, 15, 16 17, 18, 19, 20, 21 22, 28, 29, 30, 31 36, 37, 38, 39, 40 43, 44, 45, 46, 47 48, 49, 50, 51 -39	32, 41, 42 -3	7 -1	52 -1	25 -1	23 -1	33 -1	26 -1	27 -1		24, 34 35 -3	
Chamber C	1, 2, 3, 4, 5 6, 7, 9, 10, 11 12, 13, 14, 16, 17 19, 21, 22, 23, 24 25, 26, 27, 29, 30 31, 32, 33, 34, 35 36, 37 -32	8, 15, 18, 20, 28, 39 -6				38 -1				40 -1		41 -1

CHRONOLOGY

The result of this investigation shows that the bulk of the pottery belongs to the Red Polished II Ware. Only a few pots are Red Polished III, a single pot White Painted I, and another, Black Polished. The position of these later pots does not allow one to conclude that they all belong to the latest burials in the chamber. We have, consequently, to date all, three chambers to the very beginning of the E. C. III period.

TOMB 303 (Figs. 26; 28: 1—7; 29)

	SIZE			
	Length	Width	Height	Depth
Dromos	2.54	1.58	—	1.15
Stomion A	0.56	0.83	0.65	—
Chamber A.....	2.10	2.86	1.06	—
Stomion B	1.26	0.84	0.65	—
Chamber B.....	2.35	1.80	0.85	—

SHAPE

The dromos of this tomb is broad and shallow, but of practically the same type as the above described tombs. It has, however, been defaced by various cuttings in the rock, all of a later date than the tomb. The central part of the necropolis has in later times been used as a quarry. Even now, this industry continues, both in the old cemetery and its neighbourhood, for the unusually compact and homogeneous limestone of Lapithos offers an excellent building material. Another anomaly which has no real connection with our tomb, is the curious cutting leading down to a chamber, below described under the somewhat improper heading 303 B. It is, in fact, an entirely independent tomb with its proper entrance from the North, and the connection between it and the dromos 303 is only brought about through the collapse of its roof, which took place during the cutting of the latter tomb. To protect the chamber from robbers the tomb-cutters partly cleared the dromos of Tomb 303, and blocked up the hole with several large stones. These operations show that Chamber B is later than the dromos of Tomb 303, a fact which was also demonstrated by the finds in Chamber B.

Chamber A is of medium size, and almost circular in shape with a horizontal floor and a very low roof. The entrance, which was closed by one large and some small stones, is short and wide. The proper dromos of Chamber B was never excavated. The stomion is very long and slightly curved eastwards. The explanation of this irregularity is, apparently, to be found in the fact, that the tomb-cutters have tried to avoid a collision with the dromos of the neighbouring tomb, to the West. They happened, however, to break through the thin wall, separating the two cavities, and thus the connection with Tomb 303 was involuntarily established. The shape of the chamber is oval and the size comparatively small.

STRATIFICATION

Except for the back part of the dromos, where the blocking up of the hole, leading down to Chamber B could be stratigraphically traced, the earth-filling was intact and contained a few sherds of early Red Polished Ware. From the roof and walls of Chamber A some debris had fallen, and, below this surface layer, two burials on slightly different levels were found. The later one, to which pots Nos. 19, 20, 21, and 22 belong, lay in the N.W. corner; and the earlier, which was partly disturbed and covered with some earth, was found

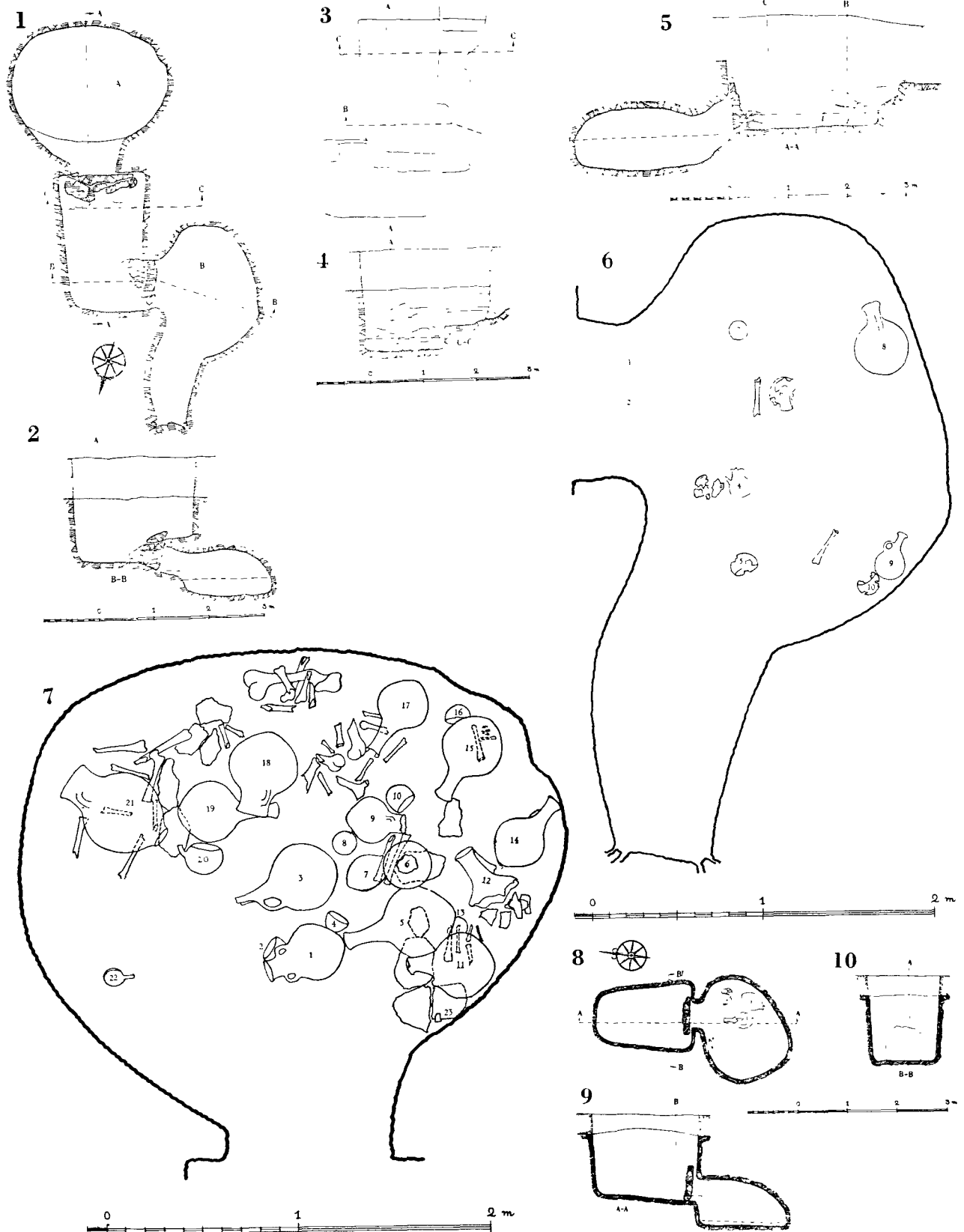

Fig. 28. Lapithos. Tomb 303, Plans (1, 3); Sections B—B, C—C, A—A (2, 4, 5); Chambers B and A with finds *in situ* (6, 7). Tomb 304, Plan (8); Sections A—A, B—B (9, 10).

along the E. side of the chamber, resting directly on the ground together with the rest of the finds. Chamber B was entirely filled with debris, emanating partly from the *chavara*, from roof and walls, and partly from silted earth and clay which had poured into the chamber from the dromos of Tomb 303. Apparently water has occasionally flooded the chamber and brought disorder among the original deposits. The few pots and bones found inside, were all lying on different levels in the clay, but these differences are, of course, of no conclusive value.

BURIALS

The two skeletons in Chamber A were badly preserved, but the positions of the vertebrae and the femora showed that they had been deposited in a slightly contracted, lateral position with the heads towards the entrance. They were both surrounded by low barriers of irregular stones. Of a special interest, is the finding of a great part of the skeleton of an ox, and some fragments of a dog's skull. The former were apparently, the remains of offerings, meant for the funeral meal, while the latter was sacrificed at the burial ceremony of his master, to follow him as a servant into the other world.

FINDS (GROUPS: PLS. XIV, 3, 4; TYPES: L. OF PL. II)

Chamber A

1. Red Polished I globular amphora with flat, raised base; wide, concave neck, splaying rim, and two handles from neck to shoulder. Height 43.5. Floor.
2. Red Polished I deep bowl with round base, and a string-hole projection below rim. Black rim and inside. Diam. 13.8. Floor.
3. Red Polished I globular jug with slightly pointed base; concave, cut-away neck, splaying rim, and handle from neck to shoulder. Two buttons in relief on neck at top of handle. Height 52.5. Floor.
4. Red Polished I deep bowl with pointed base with a small circular cavity, and two hooked projections on rim. Black rim and inside. Concentric semicircles hanging from rim, a band of parallel lines below rim, and three hatched zigzag elements around body. Diam. 12.0. Floor.
5. Red Polished I globular jug as No. 3, but with snake ornaments in relief on neck. Height 57.3. Floor.
6. Red Polished I globular amphora with flat base, and wide, concave neck. Handles, rim, and part of body missing. Surface worn. Height 39.5. Floor.
7. Red Polished I globular jug as No. 3. Height 39.5. Floor.
8. Red Polished I globular amphora with flat base, concave neck, splaying rim, and two handles from neck to shoulder. One handle missing. Height 18.7. Floor.
9. Red Polished I amphora as No. 1. Rim missing. Height 33.6. Floor.
10. Red Polished I deep bowl with round base, slightly inwards-curved rim, and a large, hooked string-hole projection below rim. Even red. Diam. 12.0. Floor.
11. Red Polished I jug as No. 5. Piece of rim missing. Height 45.4. Floor.
12. Red Polished I globular jug with round base, concave neck, splaying rim, handle from neck to shoulder, and two button-ornaments in relief on neck at top of handle. Damaged. Height 52.5. Floor.
13. Red Polished I shallow bowl with round base. Piece of rim missing. Black rim and inside. Diam. 11.2. Floor.
14. Red Polished I jug as No. 7. Height 44.5. Floor.
15. Red Polished I jug as No. 12. Height 50.0. Floor.
16. Red Polished I deep bowl with round base, inwards-curved rim and a string-hole projection at rim. Projection missing. Black rim and inside. Diam. 13.2. Floor.
17. Red Polished I jug as No. 7. Height 45.5. Floor.
18. Red Polished I amphora similar to No. 1, but with shorter neck and flat base. Height 44.5. Floor.
19. Red Polished II globular jug with round base; tall, tapering neck, splaying rim, handle from neck to shoulder, and a horizontally pierced projection opposite the handle. Height 49.8. Floor.
20. Red Polished I deep bowl with round base, inwards-curved rim, a tubular, upwards-turned spout, provided with a string-hole; handle from rim to body opposite the spout. Handle missing. Diam. 16.0. Floor.
21. Red Polished I amphora similar to No. 18. Height 52.0. Floor.
22. Fragments of a small Red Polished II jug. Floor.
23. Whetstone of trapezoid shape. Length 4.1. Floor.

Chamber B

1. Fragments of a Red Polished II hemispherical bowl. Black inside and rim.
2. Fragments of a Red Polished III miniature jug.

3. Fragments of a Red Polished II cooking-pot.
4. White Painted II pear-shaped jug with round base, cylindrical neck, handle from neck to shoulder, and a tubular spout opposite the handle. Alternating straight and wavy lines around neck, handle and spout; broad, vertical stripes of hatched lozenges; network and zigzag lines from neck to base, and red polished base. Rim missing. Height 17.2.
5. Fragments of a Red Polished III shallow bowl with round base; even red surface.
6. Fragment of a Red Polished II bowl similar to No. 1. Floor.
7. Red Polished III shallow bowl with round base, and a small string-hole projection at rim. Diam. 10.6. Floor.
8. Red Polished IV globular hydria with flat base-knob; concave neck, a horizontal handle on shoulder, and a vertical handle from neck to shoulder. Height 45.0.
9. White Painted II pear-shaped jug with round base; tall, cylindrical neck, stilted rim, and handle from neck to shoulder. Friezes of network and zigzag lines around neck; red polished base, and broad, vertical stripes of network and parallel zigzag lines from neck to base. Diam. 29.0.
10. Fragments of a Red Polished II bowl similar to No. 1.

The contents of Chamber A is distributed between the different burials according to the following diagram:—

	P o t t e r y						Stone
	R. P. I			R. P. II			Wh st.
1st burial	1.	2.	3.	4.	5.	6.	
	7.	8.	9.	10.	11.	12.	
	13.	14.	15.	16.	17.	18.	
			-18		.		
2nd burial	20, 21			19, 22			23
	-2			-2			-1

CHRONOLOGY

Both the shape and pottery of Chamber A show distinctly early signs, and the low and shallow dromos and the absence of bronze objects bespeak an early date, too. The pottery belonging to the first burial is all Red Polished I Ware: Bowl No. 4, a unique type, ought also to be placed in the same class, in spite of its incisions. The possibility of its being imported cannot, however, be excluded, but it seems equally certain that it cannot belong to Red Polished II. Among the gifts of the second burial, are found two Red Polished II vases and the burial must therefore be dated to the beginning of E. C. II period. The first burial, however, is well within E. C. I.

Chamber B has, as pointed out above, very little conclusive value. To judge from the contents it probably contained more than one burial. Different kinds of pottery were represented as follows.

R. P. II	R. P. III	R. P. IV	Wh P. II
1, 3, 6, 10	2, 5, 7	8	4, 9
-4	-4		-2

It belongs to Middle Cypriote II.

Fig. 29. Lapithos. Tomb 303 A. Interior view with finds *in situ*.

Fig. 30. Lapithos. Tomb 311, dromos.

TOMB 304 (Fig. 28:8—10)

SIZE

	Length	Width	Depth	Height
Dromos	2.13	1.43	1.38	—
Stomion	0.24	0.46	—	0.44
Chamber	1.67	2.00	—	0.90

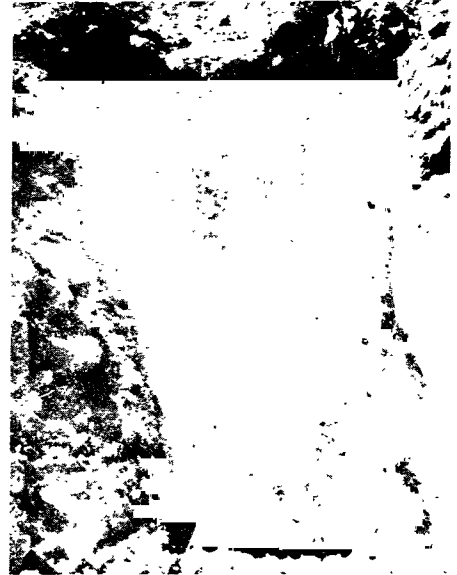
SHAPE

The dromos is of the usual bucket-shaped type with almost vertical sides, slightly sloping floor, and a narrow entrance at the short front end. The door is roughly square in shape, and was closed by a single block of local limestone. Immediately inside the door there is a deep step, leading into the small circular chamber. The floor of the chamber which is perfectly horizontal, is cut down to 0.45 m. below that of the bottom of the dromos, and roof and walls which mainly are well preserved, form a low, flat vault.

STRATIFICATION

The earth, filling the dromos, consisted of a single layer of *chavara*, mixed with a small amount of early Red Polished potsherds. The stratum projects slightly above the level of the natural rock, where the cutting of the dromos was begun. This fact seems to support the presumption that the rock lay almost bare at the time of the building of the tomb, and

that, consequently, the grave was marked by a low heap of earth. Of course it can by no means be compared with a real tumulus, which was a mound of earth, piled over the tomb, with the intention of giving it a monumental aspect. In this case, it is only the earth emanating from the hollowed-out chamber, that was used in the first place to refill the dromos, and, the superfluous debris heaped on top of the dromos.

Practically, no earth had poured into the chamber, from the door, and finds and skeletal remains were only covered by *chavara* debris fallen from the roof. The damage, caused to the deposit was, however, very great. Only one burial had taken place in the tomb, and minute remains of a male skeleton were found in the W. part of the chamber. A bronze dagger, found in the burial stratum had probably been placed in his hand, or hanging from his belt. Three jugs in the opposite corner of the chamber were the only ceramics found, and all of them were badly damaged by pieces of rock from the roof.

BURIAL

No conclusions as regards the position of the dead body could be drawn because of the bad state of preservation of the remains. There was, as a matter of fact, only a dark layer on the ground which indicated the place, where the corpse had once been deposited.

FINDS (PL. CXLII, 7)

1. Red Polished II globular jug with rounded base; tall, tapering neck, splaying rim, a knobbed handle from neck to shoulder; relief decoration on neck and shoulder. Very badly damaged. Height 59.1. Floor.
2. Fragments of a Red Polished I large jug similar to No. 1. Floor.
3. Red Polished I globular jug with rounded base; tapering, cut-away neck, splaying rim, and handle from neck to shoulder. Button-ornaments at top of handle. Height 52.1. Floor.
4. Triangular bronze dagger with straight sides, pointed end, angular top, two edges, high midrib, and short, solid, tapering tang. Length 20.6. Floor.

The short Object Register is summed up here below.

P o t t e r y		Bronze
R. P. I	R. P. II	Dagger
2, 3	1	4
-2	-1	-1

CHRONOLOGY

The Object Register shows the early date of the tomb. Of the three pots, two belong to the Red Polished I class, and the third is a fairly early Red Polished II type. Also the dagger, typologically must be placed early, from its triangular outline. Considering the primitive shapes and small sizes of dromos and chamber, and the fact that only one chamber was cut from the dromos, and only one burial of striking poverty has taken place, it seems fairly safe to assign the tomb to a period, earlier than the most flourishing period of the necropolis, which extends from the middle of E. C. II to the end of E. C. III. I am inclined to date the tomb to the transition between E. C. I and E. C. II.

TOMB 305 (Fig. 31: 1—3)

	SIZE			
	Length	Width	Height	Depth
Dromos	2.85	1.59	—	1.05
Stomion A	0.40	0.62	0.64	—
Chamber A.....	1.65	2.11	0.80	—
Stomion B	—	—	—	—
Chamber B.....	c.2.00	2.40	c.0.90	—

SHAPE

The dromos is bucket-shaped with vertical sides and approximately horizontal floor. Two chambers are cut from the sides of the dromos, one from the N. straight front end, and one from the S. apsidal back wall.

The stomion of Chamber A was blocked by a thin slab of local limestone, kept in place by small stones along the sides. A step — about 0.30 m. in height — leads down to the smooth, levelled floor of the chamber, which has an oval shape. Roof and walls are well preserved and, form a low, almost flat vault, reaching its apex in the centre of the chamber.

The front part of Chamber B on the opposite side of the dromos was very much destroyed. The façade and a considerable part of the roof had fallen in, and consequently, the door stone which was of exceptionally large dimensions, was only kept *in situ* by the masses of earth, which had penetrated into the chamber from above. The cave was of the same oval shape as Chamber B, but with a comparatively short transverse axis.

STRATIFICATION

The dromos earth was divided almost horizontally, into two layers, the upper consisting of *chavara*, mixed with potsherds mainly of the Red Polished II class; the lower which was only about 0.25 m. deep, of *chavara* and clay compressed into a hard mass, containing only a few potsherds.

This stratification must be interpreted as an indication of repeated burials in the chambers. Evidently, the dromos has not been completely cleared of its earth-filling every time one of the chambers was opened for a burial. The bottom layer, which was hard packed and contained a small amount of potsherds, was the remainder of the original filling, but the loose top stratum has been dug through several times.

In Chamber A, which was found entirely filled with debris, a certain stratification could also be traced, but, unfortunately its conclusive evidence is very limited. Because of the situation of the tomb close to a depression in the ground, which, in winter time, serves as outlet for masses of water running down from the Kerynia mountains on to the narrow strip of cultivated plain along the shore, the tomb has been so filled with mud and water as to render any safe observations on the original stratification very problematic. The large jugs of the Red Polished Ware with their narrow necks especially have floated

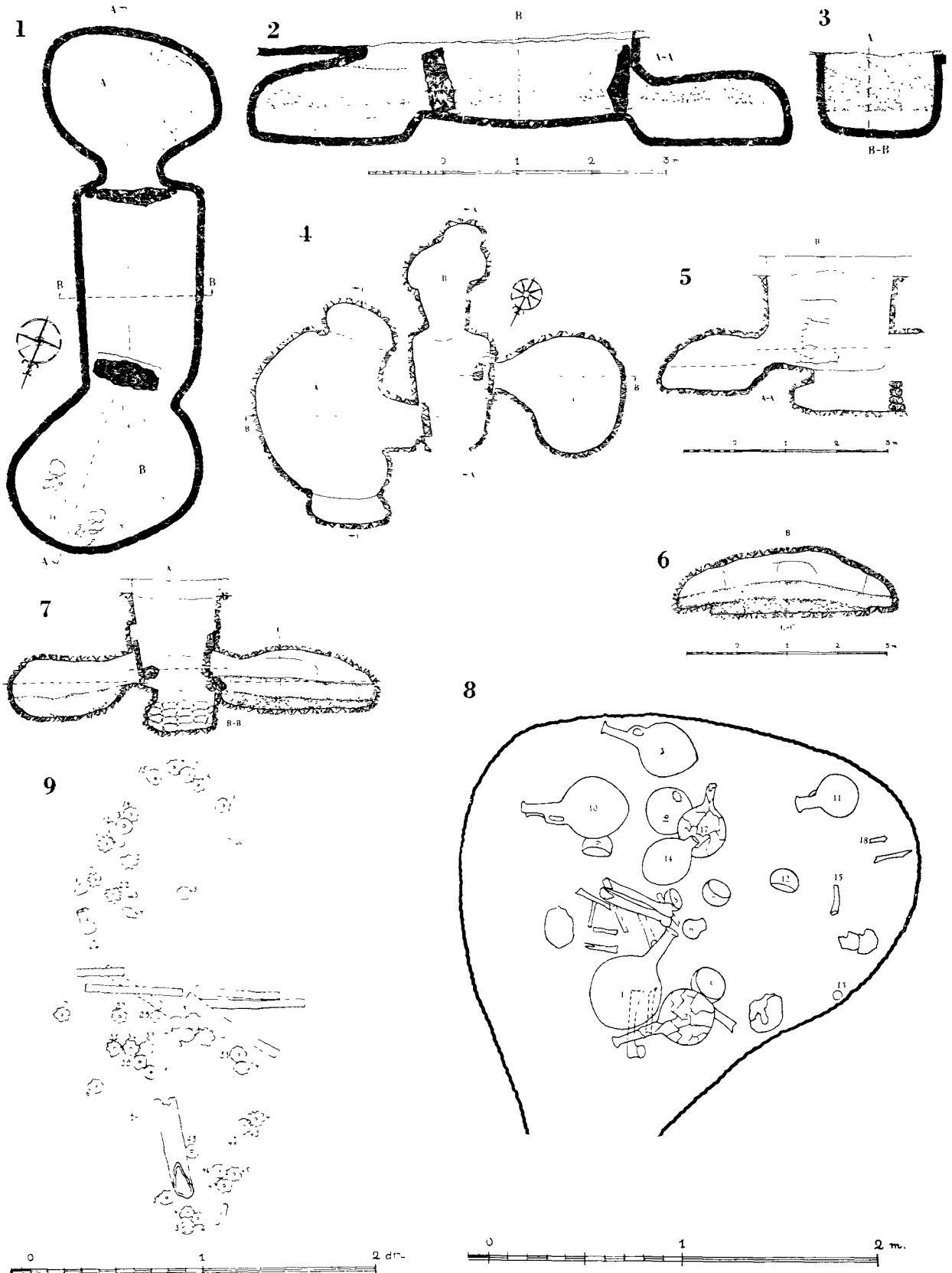

Fig. 31. Lapithos. Tomb 305, Plan (1); Sections A-A, B-B (2, 3). Tomb 306 Plan (4); Sections A-A, C-C, B-B (5, 6, 7); Chamber C, Finds *in situ* (8); Necklace No. 24 in Tomb 306 A *in situ* (9).

about in the chamber, as well as some light skeletal remains which have been removed by the water. One layer, however, seemed to be intact. It separates the dark earth lying directly on the floor from the upper debris, and contains scanty fragments of two skeletons and some pottery.

Chamber B was in the same state as the above. Mud and water had freely permeated into the tomb, especially after the collapse of the façade and the front part of the roof. Consequently the evidence from the stratification is very meagre. The original layers were found turned upside down and mixed with silted clay and sand from the floods of the winter-rains. Some heavy fragments of a pithos — No. 13 — had, however, remained *in situ* on the floor.

BURIALS

In Chamber A were found the scanty and mouldered fragments of three skeletons, one high up in the secondary filling and two approximately *in situ* in the lower layer. The former certainly cannot contribute to our knowledge of the burial habits of the epoch, as it was not found in its original position, but the other two might, however badly preserved they were, help in some fairly reasonable conjectures. In the N. E. corner of the chamber a flat stone lay directly on the floor and upon the stone were found two tibiae and one fibula. On the floor, and touching the upper part of the tibiae was a femur, and close to it fragments of another similar bone. Across the latter lay pieces of a humerus and the much broken remains of a skull lying on its right side. Tibiae, fibula, femora, humerus and skull evidently belonged to the same skeleton.

To what conclusions as regards the original position of the dead body does the relative position of its remains lead? The legs are bent at right angles, at the knees, and the arms partly cross the femora; considering the fact that the extent of the area over which the bones are spread, is only approx. 0.60 × 0.40 m., it seems reasonable to presume that the original position has been much contracted. The head was, however, found in a position which prevents one from assuming a laterally contracted position, a so called "Hocker"; viz. there is no place for the spinal column. Consequently, it is most likely that the dead body has been placed in a crouching position with the arms round the knees. The actual position of the head was apparently due to the collapse of the body. The flat stone has, in such a case, served as a rest for the feet, and the corpse has been sitting in the corner of the chamber, facing the entrance. A circumstance which corroborates this view is the presence of another skull and some fragments of legs, close to the above skeleton. The levels of the two skeletons show that they are approximately contemporaneous, and the limited space in the corner at their disposal does not seem to admit of any other position for the two bodies.

Chamber B has no skeletal remains in an intact position, but along the E. side of the chamber was found a large sherd of a pithos, on which were placed several bones. They all belonged to the first burial of the tomb, and have evidently been removed to make room for a second body, which however, could not now be traced because of the ruined condition of the tomb.

FINDS

The bad state of preservation of the contents of the tomb prevented detailed description of the pottery.

C h a m b e r A

1. Red Polished III jug with spout. Height 17.5. + 8.
2. Flat, rectangular idol of terracotta with flat rectangular head, and two small projections for the shoulders. *Head*: Two dots indicate the eyes, surrounded by short, radiating lines; three long, vertical lines represent the nose, and one circular dot the mouth. The hair is indicated by short horizontal lines at the sides of the face, and the hair ornament by two vertical bands at top of head. At the back the hair falls in zigzag plaits to the shoulders. Hair ornament not shown at the back. *Dress*: Round neck is a large necklace, in two parts; the first tightly twisted around the neck; the second hanging down from the shoulders over the breast. The larger beads are marked by dots. The necklace is not shown on the back. The dress seems to be a wide gown reaching to the feet, with long, wide sleeves; it is held together at the waist by an embroidered girdle, and decorated with a broad border at the height of the knees. The sleeves are indicated by long, oblique lines, ending in dots. At the back the stuff is ornamented with small squares of parallel, horizontal lines forming an irregular chess-board pattern. Surface rather worn. Head chipped; repaired. Length of body 18.1. Width of body 9.7. Length of head 10.9. Width of head 4.8. + 4.
3. Red Polished II hemispherical bowl. Diam. c. 10.0. + 3.
4. Red Polished III jug. + 27.
5. Black Polished incised, hemispherical bowl. Diam. 9.5. + 2.
6. Red Polished II cooking-pot. Height 13.5. + 3.
7. Red Polished II jug. + 11.
8. Red Polished II jug. + 12.
9. Bronze knife with convex sides, pointed end, two edges, low midrib, rounded shoulders, and flat, tapering tang with one nail at the top. Length 15.9. + 2.
10. Red Polished II hemispherical bowl. + 6.
11. Red Polished II jug. + 6.

12. Red Polished III jug. — 2.
13. Red Polished II jug. — 10.
14. Red Polished II jug. — 7.
15. Red Polished II jug. — 4.
16. Red Polished II incised amphoriskos. — 39.
17. Red Polished III jug with spout. — 36.
18. Red Polished II hemispherical bowl. — 34.
19. Red Polished II pot. — 15.
20. Red Polished II hemispherical bowl. — 17.
21. Red Polished III jug with beaked mouth. — 14.
22. Red Polished III jug. — 22.
23. Red Polished III incised amphora. — 25.
24. Red Polished II hemispherical bowl. Diam. c. 9.5. — 26.
25. Triangular bronze dagger with somewhat convex sides, pointed end, two edges, midrib, and a thin hooked, solid tang. Length 25.5. — 40.
26. Red Polished II hemispherical bowl. — 38.
27. Red Polished II pot. Floor.

C h a m b e r B

1. Red Polished II hemispherical bowl. Diam. 11.7. Floor.
2. Red Polished II jug. Floor.
3. Red Polished II hemispherical bowl. Floor.
4. Red Polished II jug. Floor.
5. Red Polished II bowl. Floor.
6. Red Polished II hemispherical bowl. Floor.
7. Red Polished II hemispherical bowl. Diam. 12.2. Floor.
8. Red Polished II, oval amphora with flat raised base. Height c. 45.0. — 53.
9. Red Polished II jug. — 23.
10. Red Polished II jug. — 23.
11. Red Polished II jug. — 13.
12. Red Polished II jug. — 50.
13. Red Polished II jug. Floor.
14. The half of a Red Polished II pithos. Height c. 75. — 54

Summing up the description given in the Object Register, we obtain the following diagram.

	P o t t e r y			B r o n z e		Terracotta
	R. P. II	R. P. III	Bl. P.	Knives	Daggers	Idol
Chamber A	3. 6. 7. 8. 10. 11 13. 14. 15. 16. 18 19. 20. 24. 26. 27 -16	1, 4. 12. 17. 21, 22. 23 -7	5 -1	9 -1	25 -1	2 -1
Chamber B	1. 2. 3 4 5. 6. 7. 8 9. 10. 11. 12. 13. 14 -14					

CHRONOLOGY

Chamber B shows a homogeneous content of Red Polished II Ware, and some of the specimens are even of a rather early type within their class. Thus, the amphora with flat base (No. 9) and the pithos with wide, concave neck (No. 14) are distinctly early examples of the Red Polished II Ware. In the other chamber there were originally two separate layers, but because of the disturbed stratification, the contents cannot be divided between the two periods. It is easy, however, to trace them, and without doubt, the bulk of the Red Polished II Ware belonged to the older period; also the bronze dagger (No. 25) which is a typical early shape. The rest of the contents must be assigned to the later period. Chamber B can, consequently, be dated to the very beginning of E. C. II; the first burial of Chamber A, to well within E. C. II and the last burials in the same chamber, to the beginning of E. C. III.

TOMB 306 (Figs. 31: 4—9; 32: 1)

SIZE

	Length	Width	Height	Depth
Dromos	2.45	1.56	—	1.95
Stomion A	0.80	1.08	0.82	—
Chamber A	2.42	4.30	1.25	—
Stomion B	0.90	0.96	0.58	—
Chamber B	1.16	1.55	1.12	—
Stomion C	0.48	0.80	0.60	—
Chamber C	2.06	2.28	1.08	—

SHAPE

The dromos is bucket-shaped, rather large in size, with sides tapering downwards, and an approximately horizontal floor. The apsidal, north, end of the dromos has, however, been destroyed by the cutters of the neighbouring tomb No. 315 (see below p. 106), who struck upon it when hollowing out the large chamber 315 B—C. In order to prevent the threatened collapse of the tomb, the construction of which had been considerably weakened by the passage involuntarily opened into our dromos, a wall of rough stones was built to fill the gap and support the roof of the chamber 315 B—C. To give sufficient strength to the wall, the floor of our dromos was cut down to the level of the floor in the chamber, and afterwards filled up with stones. All these circumstances are of course sure proof that Tomb 306 is older than Tomb 315.

From the dromos were cut three chambers. Chamber A, opening from the long E. side is the largest of the three. The door, consisting of a large slab of local stone, was approximately *in situ*, and had certainly not been opened, when found by the later cutters of Tomb

315. The threshold, however, had been almost obliterated by the widening of the dromos to found the substructure wall, and the heavy door stone had been kept from falling by some stones which have been wedged into their present position below the door stone.

The chamber, into which leads a widening and sloping stomion, is kidney-shaped, with two niches on the short sides slightly raised above the floor. The floor is horizontal and the whole chamber symmetrical in plan.

Chamber B, which opens from the short S. side was a small ossuary with a long, sloping stomion, no door stone and an irregularly trefoil-shaped chamber with horizontal floor and low, vaulted roof.

The third chamber was carefully blocked up by a large slab, surrounded by smaller stones at the edges. The door was sunk into a rectangle in the face of the rock and the stomion, which was smaller than the outline of the door, sloped abruptly down to the level of the floor of the chamber. The shape of the chamber is roughly circular with horizontal floor and flat, vaulted roof.

STRATIFICATION

In the stratification of the dromos the operations of the workmen, who cut the neighbouring tomb 315 could be clearly traced. Their emptying and refilling of the south part of this dromos could be followed in a thick, perpendicular layer of mud and *chavara* mixed with stones: its limit towards the North was clearly marked. The original filling, which could be studied there, seemed to have been homogeneous, and it could be seen that no burial had taken place in this tomb after the intrusion from Tomb 315, i. e., the latest burial in this tomb is earlier than the first burial in Tomb 315 B—C.

Chamber A was filled to a height of about 0.65 m. by a horizontal layer of silted clay, mixed with debris fallen from roof and walls: this filling was stratified in two layers of about the same consistency. The original stratification of the chamber had been disturbed by this secondary invasion of mud and water from the entrance, and the actual position of the finds did not give any guide as to their relative dates.

The small chamber at the north end of the dromos was not closed by a door stone, and, consequently, the original dromos-filling had filled the cavity. In the innermost corner, was a thin bottom layer of dark earth, emanating from mouldered skeletal remains and still containing fragments of bone.

The stratification of Chamber C is practically the same as that of Chamber A: the chamber has been more or less filled with water, and a thick layer of silted mud and rock debris bears witness to its fatal effect. In, and upon, the mud were found fragments of skeletons and finds, many of them certainly moved from their original positions. The large jugs of the Red Polished Ware especially have floated about, and were all found on the surface of the mud stratum.

On the floor, however, a dark layer of culture earth of varying thickness could be traced containing skeletons and smaller finds, most of them, apparently, *in situ*.

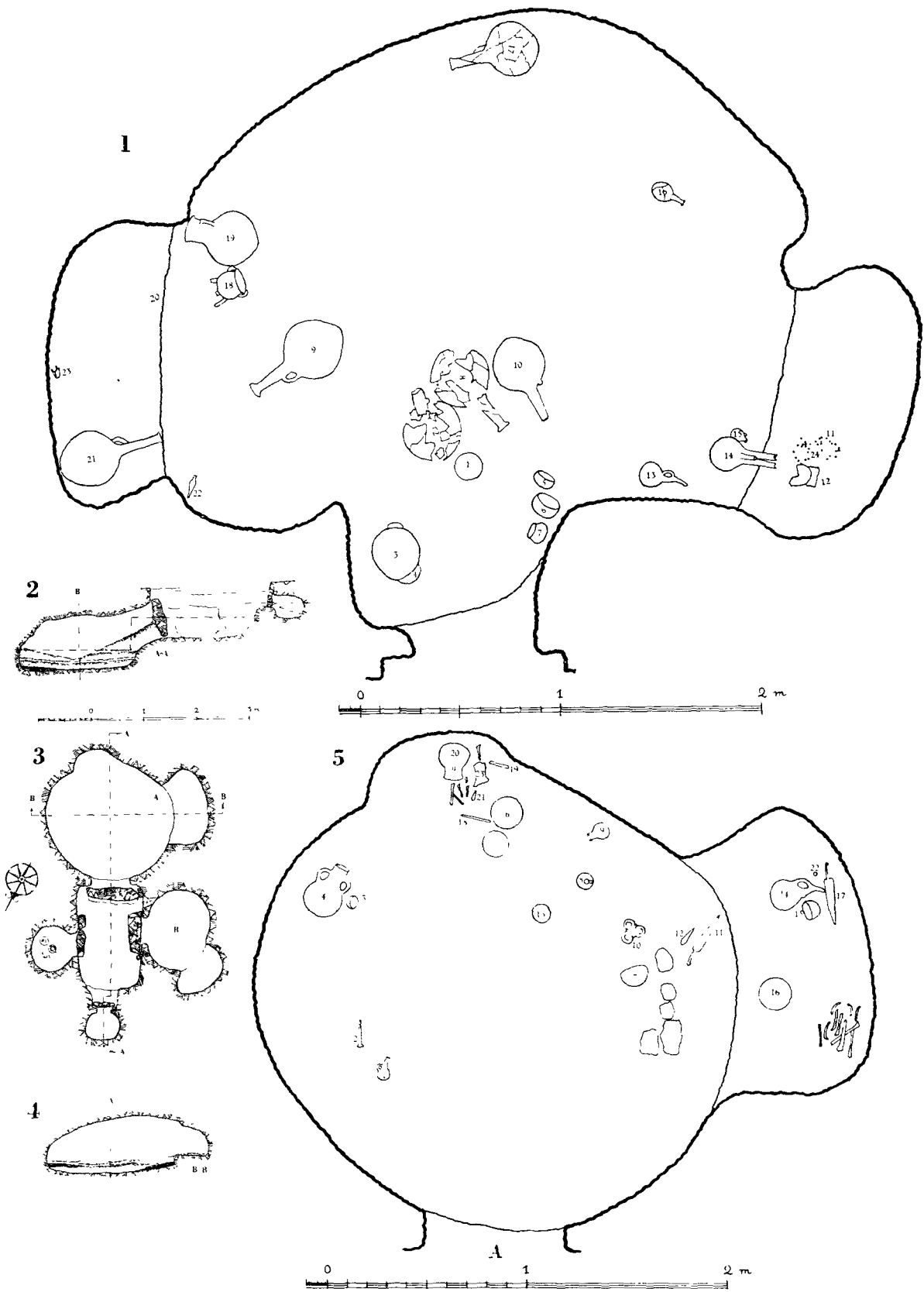

Fig. 32. Lapithos. Tomb 306, Chamber A with finds *in situ* (1). Tomb 307, Plan (3); Sections A-A, B-B (2, 4); Chamber A with finds *in situ* (5).

BURIALS

A characteristic feature of Tomb 306 is the presence of a special ossuary where the remains of the earlier burials were deposited when the chambers were reused. This circumstance explains the fact that so few remains of bodies were found inside the chambers, especially Chamber A where only one skeleton could be traced. Of this skeleton only head, neck and pieces of the arms were found in the N. niche, and the remains were too scanty to allow of any certain conclusions being drawn as to the burial customs; but it is worth mentioning that a plank-shaped, female idol was found immediately below the head, and, to judge from the position of the necklace No. 24, it was roughly *in situ*. This being so, it seems reasonable to presume that the dead body was placed in a lying position, but as the length of the niche was only about 1.00 m., the body must, in any case, have been much contracted.

Considering the remains *in situ* in Chamber C, they seem in some points to give better evidence: one skeleton, of which skull, arms and legs were fairly well preserved, leaves no doubt that it originally was placed in a sitting position close to the entrance by the N. wall of the chamber; the knees have been much bent, and feet and tibiae were found below the femora. The bent elbows indicate that the dead body has been in a squatting position with the arms around the knees.

The remains of the two other skeletons show the same position, but with legs crossed.

FINDS (GROUPS: PL. XVIII, 1—3; TYPES: L. OF PL. II)

Chamber A

1. Red Polished II hemispherical bowl with a string-hole projection at rim. Black inside and rim. Diam. c. 15.0.
2. Red Polished III large jug; much damaged. Height c. 54.0.
3. Red Polished II large jug; much damaged.
4. Red Polished II bowl as No. 1. Diam. 13.0.
5. Black Polished hemispherical bowl. Incised horizontal lines around rim, and two friezes of parallel zigzag lines around body. Diam. 10.2.
6. Red Polished II bowl as No. 1. Diam. 12.0.
7. White Painted II squat, pear-shaped amphora with broad, short neck; straight rim, and two small, angular handles from neck to shoulder. A framed wavy line below rim; body covered with vertical, wavy lines, bands of network, and hatched lozenges. Pieces of rim and body missing. Decoration much worn. Height 8.2.
8. Red Polished II large jug; much damaged. Height 52.0.
9. Red Polished II oval jug with round base; tall, tapering neck, wide rim, and handle from neck to shoulder. Relief-lines on shoulder. Height 55.0.
10. Red Polished II jug as No. 9. Rim and handle missing; paint much worn. Height 47.0.
11. Three beads of glass paste. See below No. 24.
12. Red Polished flat, rectangular idol with plank-shaped body, small, projecting shoulders, and a large rectangular head; projecting nose and breasts. Around the head are incised hatchings, suggesting the hair; two impressed dots on the sides of the nose, and a horizontal line below the nose represent eyes and mouth. Around neck and upper part of body are hatched, horizontal bands, representing the details of the dress. The back is decorated with three hatched bands, also suggesting the embroidery of the gown. Total length 23.8. Floor.
13. Red Polished III globular jug with round base, backwards-curved neck, beaked mouth, handle from rim to shoulder; a tubular spout and a string-hole opposite the handle. Spout missing. Encircling, incised lines around neck, and three friezes of parallel zigzag lines around body. Transverse lines on handle. Height 25.0.
14. White Painted II pear-shaped jug with round base, two backwards-curved necks; beaked mouths; twisted fork-handle from rim to shoulder; a string-hole between the necks, and a tubular spout opposite the handle. Straight and wavy lines around necks and spout, a vertical zigzag line from rim to neck; broad bands of network and lattice-lozenges, flanked by wavy lines, from base of neck to bottom, and a band of chess-board squares and parallel zigzag lines below the handle. Height c. 30.0.
15. Black Polished double-conical jug with flat base, and a knob opposite the handle. A skeuomorphic decoration of concentric circles joined by hatched bands covers the body. Neck and handle missing. Height 9.0.
16. Red Polished II oval jug with tapering neck, and handle from neck to shoulder. Much damaged. Height 17.0. Floor.

17. Red Polished II jug as No. 9. Much damaged. Height 48.0. Floor.
18. Red Polished II globular cooking-pot with three legs, splaying rim, and two handles from rim to body; one leg missing. Height 15.3. Floor.
19. Red Polished II globular amphora with concave neck, splaying rim, and two angular handles from neck to shoulder. Flattened base. Height 38.0. Floor.
20. Red Polished II large jug, entirely smashed. Floor.
21. Red Polished II jug as No. 9. Height 52.0. Floor.
22. Leaf-shaped bronze knife with concave sides, rounded end, two edges, midrib, and flat, tapering tang with one rivet-hole. Length 11.0. Floor.
23. Bronze knife as No. 22. Blade bent. Length c. 9.5. Floor.
24. Necklace of fifty paste beads. The composition of the necklace could be studied thanks to its approximately intact position, and it could be reconstructed with a certain degree of exactness. The centre of the necklace is a fluted, cylindrical bead, surrounded by two globular, fluted beads, and two biconical beads. Thereafter follow three, globular, fluted ones, and one plain globular. The following series consists of globular, fluted beads with a few exceptions, which are of the plain, globular and biconical types. One is singular. It is a rough representation of a frog. Most of the beads have been coloured and glazed. To the necklace belong fragments of a tight bronze spiral which might have served as a clasp. Floor.
- C h a m b e r C
1. Red Polished II globular jug, with rounded base; tall, tapering neck, splaying rim, and handle from neck to shoulder. Height 58.5.
2. Red Polished II globular jug, similar to No. 1, but with very narrow neck. Height 56.0.
3. Red Polished II jug as No. 1. Height 51.5.
4. Red Polished II large jug, entirely smashed.
5. Red Polished III bowl, with a string-hole projection below rim. Even red. Diam. 18.0.
6. White Painted II pear-shaped amphoriskos with round base; wide, cylindrical neck, flat rim, and two small, knobbed handles from neck to shoulder. A network frieze around neck, and broad, vertical bands of network and lattice-lozenges on body. Height 11.5.
7. Red Polished II hemispherical bowl with a string-hole projection below rim. Black rim and inside. Diam. 14.0.
8. Red Polished II bowl as No. 7. Even red. Diam. 11.0.
9. Red Polished II bowl as No. 7. Black rim and inside. Diam. 15.0.
10. Red Polished II globular jug with round base; tall, cylindrical, cut-away neck, and a narrow handle from neck to shoulder. Height 58.0.
11. Red Polished III globular jug with cylindrical neck; splaying, flat rim, and an incised handle from neck to shoulder. Height 32.1.
12. Red Polished II bowl as No. 7. Black rim and inside. Diam. 13.0.
13. Incised Red Polished conical spindle-whirl. Diam. 4.0.
14. Red Polished II large jug. Neck missing. Height 34.0.
15. Red Polished II globular jug with cut-away neck; much damaged.
16. Red Polished II globular jug; much damaged.
17. Red Polished II large jug; much damaged.
18. Red Polished II large jug; much damaged.

The Object Register can be summed up in the following diagram: —

	P o t t e r y				Bronze	Terracotta	Faience
	R. P. II	R. P. III	Bl. P.	Wh. P. II	Knives	Sp.wh. Idol	Necklace
Chamber A	1, 3, 4, 6, 8 9, 10, 16, 17, 18 19, 20, 21 -13	2, 13 -2	5, 15 -2	7, 14 -2	22, 23 -2	12 -1	11-24 -1
Chamber C	1, 2, 3, 4, 7 8, 9, 10, 12, 13 14, 15, 16, 17, 18 -15	11, 5 -2		6 -1		13 -1	

CHRONOLOGY

Both chambers have been used at two separate periods, but it is, unfortunately, impossible to use the stratigraphical evidence to distribute the contents of the tombs among them. All the Red Polished II Ware corresponds in shape and fabric to the types assignable to

the middle of the E. C. II period, but the presence of the White Painted II pots and of the Black Polished pot No. 15 in Chamber A, which is very advanced in shape, suggest a considerable elapse of time between the two periods. The latest pots of the chamber must be dated to the middle of E. C. III.

TOMB 307 (Figs. 32: 2—5; 33: 1)

	SIZE			
	Length	Width	Depth	Height
Dromos	1.98	1.24	0.92	—
Stomion A	0.15	0.70	—	—
Chamber A.....	2.44	3.08	—	1.02
Stomion B	0.11	0.45	—	0.38
Chamber B.....	1.15	2.18	—	0.90
Cupboard 1	0.43	0.59	—	0.34
Cupboard 2	0.55	0.64	—	0.35
Cupboard 3	0.77	0.86	—	0.54

SHAPE

The dromos, as most of the tombs, found at Vrysi tou Barba, is bucket-shaped with almost perpendicular long sides and an obliquely sloping, semicircular short end. The large chamber (Chamber A) opens from the S. narrow end of the dromos and is blocked by a thick, single block. The stomion is exceptionally short, and leads by a steep sloping step, down to the floor of the chamber. The shape of the chamber is almost circular, with a shallow recess in the back wall, facing the entrance, and an oblong niche, raised about 0.20 m. above the floor, on the W. side.

Chamber B has its entrance from the W. side of the dromos. It is small and oval in shape and provided with a niche of the same type as that of Chamber A; but here, it is almost as large as the chamber. The stomion is short, and immediately inside the door, which was closed by a large block wedged with smaller stones, is a deep, perpendicular step, leading down to the floor.

Along the sides of the dromos were found three small cupboards, cut in the rock, like miniature chambers. They are all oval or sack-shaped, and closed by a single stone, sunk in a frame cut round the openings. Cupboard 1 was situated on the same side as Chamber B, No. 2 in the semicircular end of the dromos, and No. 3 opposite Chamber B on the long E. side.

STRATIFICATION

The dromos was filled with *chavara*, stratified in two layers, both containing a considerable amount of potsherds, chiefly of the Red Polished III class. The lower layer is thickest at

the north end of the dromos, where it reaches the upper end of the door stone of Cupboard 2: it tapers towards the entrance of the front chamber and peters out at Stomion A. The stratification indicates, of course, a secondary burial in Chamber A. But in the partial excavation of the dromos on that occasion, only the earth obstructing the entrance to Chamber A, was removed. This circumstance gives us a certain information as to the relative date of the burials, viz. the last burial in Chamber A is later than any of the deposits in the other chamber, or in the cupboards.

The layers inside Chamber A show the following sequence, counting from the top:

- 1) A fan-shaped stratum of moist dromos earth, confined to the region near the door.
- 2) A thin stratum of white debris, fallen from the roof, covering the whole area.
- 3) A layer of dark culture earth containing remains of a skeleton near the E. wall.
- 4) A thick layer of mud and *chavara*, extending all over the chamber.
- 5) Fragments of bodies resting directly on the floor, in and below the niche, and in the shallow recess opposite the entrance.

The two burials, presumed because of the conditions implied in the dromos, could, consequently, be clearly seen in the chamber. To the later one, represented by the layer 3 belong pots Nos. 1, 3, and 4, and the bronze pin, No. 2. These finds were, according to the indications of stratification in the dromos, the latest brought into the tomb. Layer 5 which represents the earlier burial period, contained the remains of three skeletons, one in the niche, one on a low bench of earth and irregular stones, below the niche, and one directly on the floor near the back wall. These three burials seem to be almost contemporary, and to them belong the rest of the objects, found in the chamber.

Chamber B was half filled with a silted mixture of clay and *chavara* emanating partly from debris from the roof, partly from the earth and water which had flowed in through the stomion. On different levels in this earth lay the finds, all belonging to a single burial which had taken place in the niche. Most of the finds had originally been placed in the niche, but were moved, together with the skull, to the edge of the niche.

The cupboards in the dromos were all more or less filled with dromos earth, which had poured in through their apertures, and their scanty contents were all found directly on the floors.

BURIALS

About the burial customs, there is very little to be said. The skeletons were so badly preserved that any conclusions about the original position of the bodies are now a matter of conjecture.

In chamber B the single skeleton is accompanied by a scraper and a knife indicating male sex, together with a female idol holding a child in her arms.

FINDS (GROUPS: PLS. XIX, I—4; TYPES: L. OF PL. II)

C h a m b e r A

1. Red Polished III globular jug with round base, short neck; beaked mouth, and a large handle from rim to shoulder. Mat embossed surface; clumsy manufacture; piece of rim missing. Height 12.5. — 8.
2. Thick straight bronze pin with pointed end, convex button-head, and an eyelet through the middle of the pin. Length 13.3. — 8.
3. Black Polished hemispherical bowl with horizontal lines around rim, and vertical hatched bands, and ladder-pattern strokes from rim to base. Very fragmentary. — 8.
4. Red Polished III oval amphora with round base, cylindrical neck, straight rim, and two handles from neck to shoulder. Height 25.8. — 8.
5. Red Polished III hemispherical bowl with a string-hole projection at rim. Even red. Diam. 12.7. Floor.
6. Red Polished III jug as No. 1, but with a string-hole projection opposite the handle. Height 25.5. Floor.
7. Red Polished III bowl as No. 5. Diam. 13.1. Floor.
8. Red Polished III pear-shaped jug with round base, tapering neck; splaying, small rim, and handle from rim to shoulder. A zigzag incision on shoulder. Paint worn. Height 9.3. Floor.
9. Red Polished III pear-shaped jug with wide, cylindrical neck, round base, stilted rim, handle from rim to shoulder, and a string-hole projection opposite the handle. Handle missing. Height 10.6. Floor.
10. Red Polished III kernos, consisting of three coupled vases with round bases, cylindrical necks, stilted rims and tubular spouts. Handle missing. Oblique, parallel, incised lines on body. Height 9.0. Floor.
11. Narrow bronze dagger with pointed end, two edges, midrib, and narrow, solid, hooked tang. Traces of windings around the tang. Length 29.1. Floor.
12. Small, leaf-shaped bronze knife with concave sides, rounded end and top, low midrib, two edges, and three rivets at top. The wooden handle can be traced. Length 9.5. Floor.
13. Black Polished hemispherical bowl. A hatched frieze around rim; body covered with horizontal lines, leaving plain a frieze of lozenges as "negative" decoration. Diam. 8.4. Floor.
14. White Painted II pear-shaped jug with backwards-curved neck, beaked mouth, handle from rim to shoulder, and a small projection opposite the handle. Horizontal lines around neck, and broad bands of network and parallel, oblique lines, with vertical, wavy lines in their interstices, from neck to base. Height 25.5. Floor.
15. Black Polished hemispherical bowl. A framed frieze of hatched lozenges below rim; broad, vertical, hatched bands, meeting in a cross at base, and hatched lozenges in the interstices. Damaged. Diam. 9.9. Floor.
16. Red Polished II deep bowl with round base, and a string-hole projection at rim. Black rim and inside. Diam. 16.5. Floor.
17. Broad bronze dagger with pointed end, two edges, midrib, and hooked, solid tang. Length 31.0. Floor.
18. Straight bronze pin with pointed end and thickening head. Length 15.6. Floor.
19. Rectangular flat idol of terracotta, put together from several pieces. A necklace falls triangularly from the shoulders in five (or six) lines. Between every second line there are oblique hatchings, probably indicating the smaller beads. The lowest line is partly dotted, thus marking the large beads at regular intervals. The necklace has probably been rhythmically arranged. The main dress is a long gown reaching down to the feet, and kept together by a thin girdle at the waist. The sleeves are indicated by vertical lines, ending in dots. The lower part of the dress is richly embroidered in three borders, designed as parallel and oblique lines. At the back, the borders have another pattern of hatched triangles, flanking plain lozenges. At the back of the shoulders are some squares of parallel horizontal lines. Head and chips of body missing. Length of body 18.2. Floor.
20. Red Polished III globular amphora with round base; wide, cylindrical neck; flat, stilted rim, and two small handles from neck to shoulders. Height 17.8. Floor.
21. Leaf-shaped bronze knife with convex sides, pointed end, rounded shoulders, two edges, low midrib; flat, narrow tang and three rivets. A wooden handle can be traced. Length 9.8. Floor.
22. Thin spiral ring of silver-lead broken into three pieces. Diam. 1.65. Floor.
23. Red Polished III bowl as No. 5. Fragmentary. Floor.

C h a m b e r B

1. Circular bronze ring with somewhat overlapping ends. Diam. 2.65.
2. Red Polished III pear-shaped jug with round base; tall, cylindrical neck; flat, stilted rim, and handle from neck to shoulder. Vertical zigzag lines and dots incised on neck. Height 27.9.
3. Red Polished III pear-shaped small jug; much damaged. Handle and neck missing. Height 8.7.
4. Red Polished III hemispherical bowl with a string-hole projection at the rim. Even red. Diam. 12.2.
5. Red Polished III flat bowl with round base. Mat mottled surface. Diam. 11.3.
6. Red Polished III jug; broken.
7. Black Polished hemispherical bowl with a string-hole projection at rim. A framed zigzag band below rim, and hatched semicircular and vertical bands on body. Diam. 10.0.
8. Red Polished III globular jug with round base, cylindrical neck, flat rim, and handle from neck to shoulder. Height 29.1.
9. Fragment of a narrow bronze spiral.
10. Red Polished II pear-shaped jug with round base; tall, narrow, cylindrical neck; wide funnel-rim, and handle

- from rim to shoulder. Bands of horizontal lines on neck; body covered with large, irregular, hatched lozenges. At the base of five of the lozenges is a small horn-shaped or crescent-shaped ornament. Height 16.0.
11. Red Polished III roughly bird-shaped vase with round base; concave, backwards-curved neck; long, beaked mouth, and an incised, twisted twin-handle from rim to back; a narrow tubular spout in front of body. Vertical zigzag lines on neck and body. Paint worn. Height 24.9.
12. Bronze pin with pointed end. Length 21.1.
13. Roughly rectangular, flat idol of terracotta with a flat, rectangular head. Paint slightly worn on the front. *Head*: Nose indicated by a projection; eyes by two dots close to the nose surrounded by punctured circles; mouth, two short horizontal lines. Nose and mouth are connected by two vertical lines, perhaps meant as nostrils, or a nose-pendant. A band round the hair, and five, merely decorative, squares of horizontal lines on cheeks and neck. On the back of the head the hair falls in zigzag plaits. *Dress*: The dress is similar to that previously described (No. 307A. 19): a long gown girdled at the waist, and richly embroidered at the lower edge. The embroidery in front is composed of hatched triangles, and behind of concentric lozenges, separated by horizontal lines. The arms are small and thin, and end in small, paw-like hands, with resp. eight and five fingers. In her arms she holds a similar, plank-shaped child, which seems to be lying in a little, portable cradle, ending in an arched cover above the child's head. The face of the child is similar to that of the mother, and its body is apparently wrapped in a cloth. Length of body 17.71.
14. Bronze knife with straight sides, pointed end, two edges, midrib, rounded shoulder, and flat, tapering tang with one rivet-hole. Length 22.8.

15. Black Polished oblong bottle with beaked mouth. Much damaged. Height 10.1.
16. Red Polished III hemispherical bowl. A band of punctured lozenges around rim, and parallel zigzag lines on body. Even red. Diam. 8.71.
17. Red Polished III pear-shaped jug with round base, and a tubular spout opposite the handle. Incised twin-handle. A vertical zigzag line on body. Neck and handle missing, paint worn. Height 13.3.

Cupboard 1.

1. Red Polished III globular jug with round base; concave, short neck, and an elevated handle from rim to shoulder. Handle missing. Height 8.8.
2. Sherd of a Black Polished, incised pot.

Cupboard 2.

1. Red Polished III globular jug with round base; narrow, cylindrical neck, handle from neck to shoulder, a tubular spout opposite the handle, and a small projection above spout. Spout, handle and rim missing. Vertical, straight and zigzag lines on body. Height 13.3.

Cupboard 3.

1. Red Polished III globular jug with round base; narrow, cylindrical neck, splaying rim, and handle from neck to shoulder. A vertical zigzag line on neck. Much damaged. Height 19.1.
2. Red Polished III globular cooking-pot with round base; short concave, wide neck, and one large and one small handle from rim to body. Much damaged. Height 15.2.
3. Red Polished III hemispherical bowl with a small projection below rim. Diam. 11.4.

A summary of the stratification and description gives the following distribution of pottery.

	P o t t e r y				B r o n z e			T e r r a c o t t a	
	R. P. II	R. P. III	Bl. P.	Wh. P. II	Knives	Daggers	Pins	Rings	Idols
Chamber A 1st burial period	16 -1	5, 6, 7, 8 9, 10, 20, 23 -8	13, 15 -2	14 -1			2 -1		
Chamber A 2nd burial period		1, 4 -2	3 -1		12, 21 -2	11, 17 -2	18 -1	22 -1	19 -1
Chamber B	10 -1	2, 3, 4, 5 6, 8, 11, 16 17 -9	7, 15 -2		14 -1		12 -1	1, 9 -2	13 -1
Cupboard 1		1 -1	2 -1						
Cupboard 2		1 -1							
Cupboard 3		1, 2, 3 -3							

CHRONOLOGY

The first burial period of Chamber A, and the burial in Chamber B together with the deposits in the cupboards of the dromos are all roughly contemporary, and it must be admitted that the second period of Chamber A does not differ essentially from the first, as regards the pottery. The Red Polished III pots Nos. 1 and 4 are slightly more advanced in their shapes than the bulk of the finds in the chamber, but certainly no great length of time passed between the two periods. The single White Painted II jug No. 14 must be regarded as a proof that the bottom layer also belongs to the later part of the E. C. III period. The tomb has evidently been used for the last time during the transition between E. C. III and M. C. I.

TOMB 308 (Fig. 33: 2—4)

	SIZE			
	Length	Width	Depth	Height
Dromos	2.20	1.46	1.45	—
Stomion	0.88	0.85	—	0.52
Chamber	2.82	3.06	—	1.10

SHAPE

The dromos is of the usual type, except that the end opposite the entrance is straight with rounded corners. A single chamber was cut from the façade of the dromos; it is entered through a small, square door, closed by a single stone, and a low, tunnel-shaped stomion which widens considerably towards the inside. The chamber is roughly circular with a low, vaulted roof. The lowest part of the floor is the centre.

STRATIFICATION

The stratigraphical arrangement in dromos and chamber are very simple. The dromos was filled by a homogeneous mass of *chavara* mixed with many potsherds chiefly of the Red Polished II class. In the stomion was a layer of dromos earth, and in the chamber, the find-stratum, which rested directly on the floor, was covered by a thin layer of white rock-dust emanating from roof and walls of the chamber.

In spite of the striking lack of stratigraphical evidence, it seems possible to distribute the contents of the tomb between several burials. A good reason for this is suggested by some low partitions of flat stones, found on the floor, and evidently, used to separate the bodies and their gifts from one another. Of the four burials, which could be traced in the chamber, the latest is that found immediately inside the door, together with the finds Nos. 1, 2, 3 and 5, and it seems fairly correct to assign the deposit of pots to the right of the entrance to this body also, as they obstruct, to a certain extent, the access to the interior of the chamber. This deposit comprises pots Nos. 11, 12, 16, 17, 18, 19, 20, 21 and 22.

The oldest burial seems to be that found in the S.E. corner of the chamber inside the

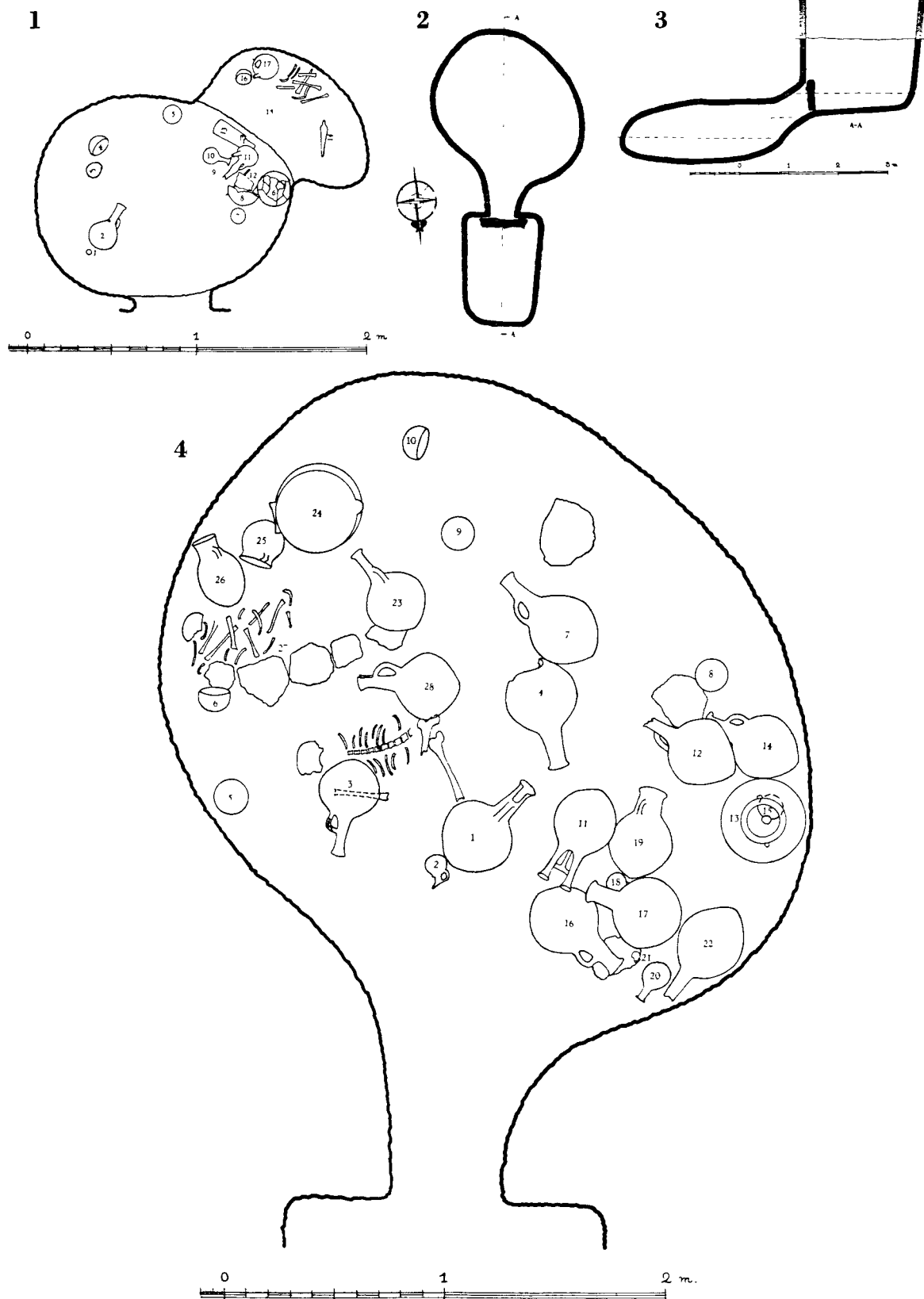

Fig. 33. Lapithos. Tomb 307 B, Finds *in situ* (1). Tomb 308, Plan (2); Section A-A (3); Finds *in situ* (4).

partition. It comprises pots Nos. 6, 24, 25, 26 and 27. A third skeleton was found near the back wall and a fourth, surrounded by some stones, along the W. wall. The latter, to which belong finds Nos. 8, 12, 13, 14 and 15, corresponds in position to the oldest burial, and its situation inside the partition, makes it reasonable to suppose that it was brought into the chamber before the former. Consequently, it is the second oldest burial of the tomb. The rest of the finds, i. e. Nos. 4, 7, 9, 10, 23 and 28 must, therefore, be attributed to the skeleton near the back wall, which according to the above argument, should be the second latest burial.

In spite of the fact, that the tomb was intact when opened, the possibility of some small disarrangement of the contents having taken place in connection with the repeated burials must be considered. The distribution carried out above, does not, needless to say, pretend to be definite, but I believe its general outline to be correct.

BURIALS

It was very difficult to judge from the actual remains, in what position the bodies had been buried. The position of the pelvis and the spinal column close to the door, however, give evidence to its original arrangement. It has, apparently, been placed in a slightly contracted position, lying on its right side with the face towards the entrance. To give any information about the three earlier burials, is impossible because of their bad state of preservation.

FINDS (GROUP: PL. XIX, 5; TYPES: L. OF PL. II)

1. Red Polished II globular jug with round base; tapering, cut-away neck, splaying rim, and handle from neck to shoulder. Three stags in relief on the shoulder. Red lustrous surface. Paint partly worn. Height 48.8. Floor.
2. Red Polished II globular jug with round base; concave, tapering neck; long, beaked mouth, handle from rim to shoulder, and a small projection opposite the handle. Height 16.5. Floor.
3. Red Polished II large, globular jug with round base; tall, narrow, concave neck, splaying rim, and handle from neck to shoulder. Paint worn. Height 44.5. Floor.
4. Red Polished II large, globular jug with round base; wide neck, splaying rim, and handle from neck to shoulder. Base smashed. Height 51.5. Floor.
5. Red Polished II hemispherical bowl with a string-hole projection at rim. Black rim and inside. Diam. 14.5. Floor.
6. Red Polished I hemispherical bowl with a string-hole projection below rim. Diam. 12.8. Floor.
7. Red Polished II globular jug with round base; tapering, cut-away neck, and handle from neck to shoulder. Horizontal, pinched relief-lines on shoulder. Half of the vase blackened. Height 52.5. Floor.
8. Red Polished II bowl as No. 5. Rim chipped. Diam. 13.5. Floor.
9. Red Polished II bowl as No. 5. Rim chipped. Diam. 15.0. Floor.
10. Red Polished II bowl as No. 5. Diam. 13.5. Floor.
11. Red Polished II oval jug with round base, two tapering necks, splaying funnel-mouths, and a curved fork-handle from necks to shoulder. Horizontal relief-lines around necks, and button-ornaments at root of handle. Paint worn. Height 48.6. Floor.
12. Red Polished II globular jug with round base, tapering neck, and handle from neck to shoulder. Pinched, horizontal relief-lines on shoulder. Rim missing; handle chipped. Height 47.0. Floor.
13. Red Polished II globular amphora with small, flat base; wide, concave neck, two handles from neck to shoulder, and a ridge between neck and shoulder. Height 50.7. Floor.
14. Red Polished II large, globular jug with round base; convex, tapering neck; wide, splaying rim, and handle from neck to shoulder. Body partly smashed. Height 45.0. Floor.
15. Red Polished II pear-shaped jug with round base; short, tapering neck; wide, flat rim, and handle from rim to shoulder. Horizontal lines around neck, shoulder and belly, and parallel, oblique lines between concentric circles around body. Height 12.2. Found inside No. 13.
16. Red Polished II jug as No. 14. Height 46.0. Floor.
17. Red Polished II globular jug with round base; wide, cylindrical neck, splaying rim, and handle from neck to shoulder. Height 48.0. Floor.

18. Red Polished II jug as No. 15. Horizontal lines around neck, shoulder and belly, and a frieze of parallel, oblique lines and concentric semicircles around body. Height 10.5. Floor.
19. Red Polished II globular amphora with round base, concave neck, splaying rim, and two handles from neck to shoulder. Height 39.3. Floor.
20. Red Polished II incised, pear-shaped jug with round base, cylindrical neck, and handle from neck to shoulder. Horizontal lines and concentric semicircles around neck; body covered with a skeuomorphic design of concentric circles, connected by horizontal and vertical parallel lines. Rim and handle missing. Height 15.2. Floor.
21. Red Polished II globular miniature jug with round base; tapering cut-away neck, and a string-hole handle from neck to shoulder. Height 5.5. Floor.
22. Red Polished II globular jug with round base; tapering neck, and handle from neck to shoulder. Button-ornaments on shoulder. Rim missing; handle chipped. Height 46.0. Floor.
23. Red Polished II globular jug with round base, tapering neck; splaying rim, and handle from neck to shoulder. Height 44.3. Floor.
24. Red Polished I large hemispherical bowl with flat bottom; short, wide, semicircular spout, and a ledge handle, pierced by two vertical string-holes. Diam. 36.6. Floor.
25. Red Polished I oval cooking-pot with round base, splaying rim, and two handles from rim to shoulder. Height 20.8. Floor.
26. Red Polished I oblong, ovoid amphora with narrow, flattened base, wide, concave neck, splaying rim, and two angular handles from neck to shoulder. Height 32.3. Floor.
27. Red Polished I large jug; entirely smashed. Floor.
28. Red Polished II large, globular jug with round base, tapering, cut-away neck, and handle from neck to shoulder. Relief-ornaments on neck. Height 43.5. Floor.

From the analysis of the burials and the classification of the pottery, we obtain the following diagram:

P o t t e r y	
	R. P. I R. P. II
1st burial	6, 24, 25, 26, 27 -5
2nd burial	8, 12, 13, 14, 15 -5
3rd burial	4, 7, 9, 10, 23, 28 -6
4th burial	1, 2, 3, 5, 11, 16, 17, 18, 19, 20, 21, 22 -12

CHRONOLOGY

All the Red Polished II Ware, except pots Nos. 2, 18, 20 and 21 which belong to the latest burial, are early specimens of the class. I want especially to point out amphora No. 13 with its flat base, and the jugs with the so called "cut-away" necks. The date of the tomb is the end of the E. C. I period, and it has been used up to about the middle of E. C. II.

TOMB 309 (Figs. 34: 1—4; 35; 37: 1)

	SIZE			
	Length	Width	Depth	Height
Dromos	3.08	1.35	1.38	—
Stomion A	0.62	0.88	—	0.50
Chamber A.....	2.60	3.71	—	0.94
Stomion B	0.63	0.94	—	0.54
Chamber B.....	2.58	3.70	—	1.14

SHAPE

The dromos is long and narrow, of the same type as those described above. The long sides are roughly parallel and vertical, and the floor is horizontal. Two chambers were found, one on the E. and one on the S. side of the dromos, both blocked by thin slabs of local limestone, wedged with smaller stones. Their shapes correspond closely to one another. Both have a narrow, tapering stomion, sloping downwards, an oval, central area and three niches, cut above the level of the floor. They were both well preserved with low, vaulted roofs.

STRATIFICATION

The dromos was filled with homogeneous *chavara* containing Red Polished potsherds, increasing in number towards the bottom. As the tomb has been opened several times for repeated burials, the lack of distinct layers seems to give a proof either that the dromos has been entirely dug out for every burial, or not filled in at all before the last. The great number of potsherds in the filling seems to favour the former hypothesis.

Chamber A contained two different find layers, separated by a very thin stratum of sand and *chavara*. Unfortunately the lower layer was badly damaged both by the moisture of the earth and by the later burials. Thus, its skeletal remains, found on the floor below the N. niche, were very fragmentary, and the finds comprised a few boxes of potsherds of the Red Polished II class, all very much destroyed by water.

The upper layer, which at the S. end was covered with some debris fallen from the roof, consisted of three skeletons; their tomb-gifts were distributed in two groups, one to the right and one to the left of the entrance. They give the impression of being approximately contemporary, and if they really represented a sequence in time, there is no traceable evidence for it now. What most denotes contemporaneity is the circumstance that jug No. 26 was found in the N. niche, except for its neck which lay in the S. niche together with a perfectly intact skeleton.

In Chamber B, one skeleton was found in each niche, together with some very well preserved pottery. Here, too, it is impossible to state, which of the burials took place first, and the state of preservation of finds and skeletons bespeaks approximate synchrony. Both the pottery and bones rested directly on the floor, and the position of the tomb-gifts did not give any further evidence.

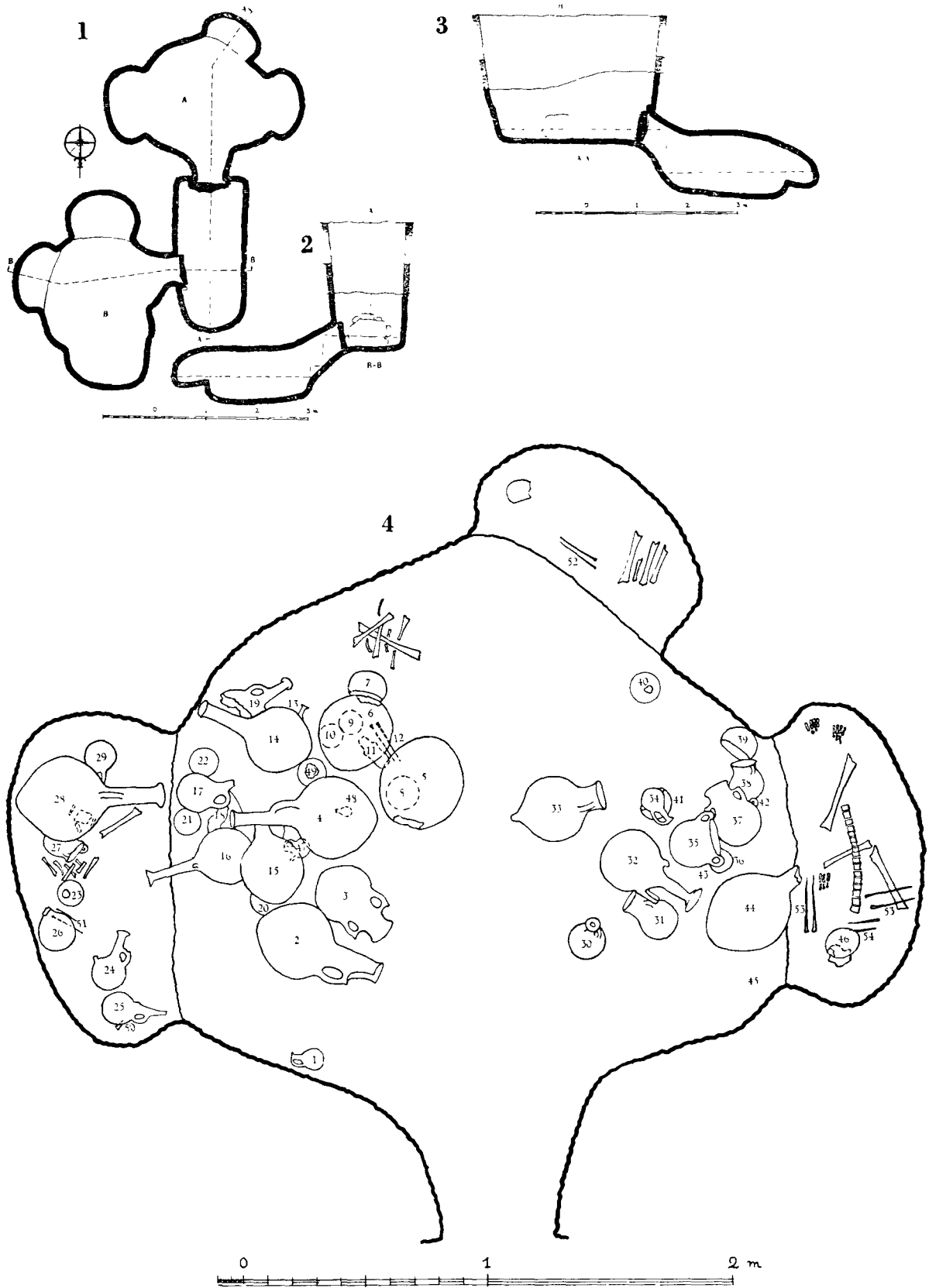

Fig. 34. Lapithos. Tomb 309, Plan (1); Sections B-B, A-A (2, 3); Chamber A with finds *in situ* (4).



Fig. 35. Lapithos. Tomb 309 A. Skeleton *in situ*.

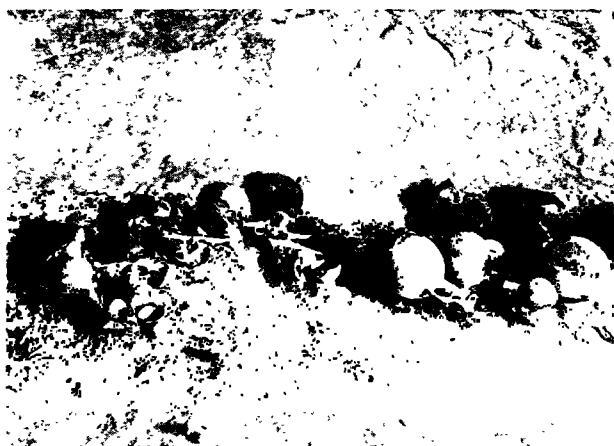

Fig. 36. Lapithos. Tomb 311 A. Interior view with finds *in situ*.

BURIALS

The best preserved skeleton of the tomb was that found in the S. niche of Chamber A (Fig. 35). It was found in dorsal position, with the arms bent across the body. The knees were drawn up, and the feet found close to the pelvis. The reconstruction of the original position is certain; the dead body has been placed on his back, with his hands on the chest and his knees tightly drawn up: in this way, the space within the niche was entirely filled. In the E. niche, the skeleton is less preserved, but the remains indicate the same characteristic position, and it seems very probable that the third skeleton in this layer had also been buried in a similar manner.

The skeletal remains in Chamber B have all to be interpreted in the same way. One detail is remarkable however, in that the body in the central niche, had its arms behind its back, in spite of its dorsal position. The position of the bones was here perfectly conclusive, as the spinal column was found above the cubital bones.

FINDS (GROUPS: PLS. XX, XXI; TYPES: L. OF PL. II)

Chamber A

1. Red Polished II incised, pear-shaped jug with round base; tapering neck; wide, almost flat rim, and handle from rim to shoulder. Bands of horizontal lines around neck, shoulder and belly, and a broad frieze of chevrons and oblique lines on shoulder. Height 11.9. Floor.
2. Red Polished III globular jug with round base; cylindrical, cut-away neck, splaying rim, and a knobbed incised handle from neck to shoulder. Vertical, pinched and wavy relief-lines on neck, and horizontal, pinched relief-lines on shoulder. Height 55.5. Floor.
3. Red Polished II globular amphora with round base; convex, tapering neck, splaying rim, and two angular handles with two knobs each from neck to shoulder. Height 37.5. Floor.
4. Red Polished III squat, almost biconical jug with narrow, flattened base; tall, tapering neck; small, splaying rim, and plain handle from neck to shoulder. A rich button-decoration on neck, and horizontal lines below rim and on shoulder. Height 58.9. Floor.
5. Red Polished III globular jug with round base; tapering neck; splaying rim, a knobbed handle from neck to shoulder, and a string-hole projection opposite the handle. Pinched and wavy horizontal relief-lines around neck and shoulder. Height 65.0. Floor.
6. Red Polished II large, globular jug with tapering neck, and wide rim. Only fragments. Floor.
7. Red Polished II hemispherical bowl with a string-hole projection at rim. Black rim and inside. Rim chipped. Diam. 13.6. Floor.
8. Red Polished II bowl as No. 7. Diam. 12.8. Floor.
9. Red Polished III bowl as No. 7. Framed, crossed zigzag

- lines below rim, and irregular, hatched lozenges on body. Diam. 8.7. Floor.
10. Red Polished II bowl as No. 7. Diam. 8.7. Floor.
 11. Rectangular, flat, incised idol of terracotta with rectangular tapering head and projecting, small shoulders. Front side badly damaged; several pieces missing. *Head*: Nose indicated by a projection, eyes by two dots close to the nose, and eyebrows by two horizontal lines. Three horizontal lines across the front and irregular short, oblique incisions along the sides of the head. *Dress*: An embroidered band round neck and shoulders, consisting of two borders of horizontal lines, and groups of short parallel zigzags, separated by a single horizontal line, interrupted by two dots. Other decorations too worn to be distinguished. The back is undecorated, except for a group of short, parallel, vertical lines on the left shoulder. Length 17.4. Floor.
 12. Two plain bronze pins with pointed ends and button-heads. Length 17.8; 17.5. Floor.
 13. Red Polished II jug as No. 1. Horizontal bands of parallel lines around neck, and vertical bands of short, horizontal elements on body. Damaged. Height 14.5. Floor.
 14. Red Polished III jug as No. 5. Height 49.5. Floor.
 15. Red Polished III jug with round base; cylindrical, backwards-curved neck, beaked mouth; incised handle from rim to shoulder; a string-hole opposite the handle, and large knobs below and opposite the handle. Vertical zigzag bands on body. Top of neck missing. Height 35.5. Floor.
 16. Red Polished III globular jug with narrow, flattened base; tall, cylindrical neck, wide funnel-rim, handle from neck to shoulder, and a string-hole projection opposite the handle; button- and string-ornaments on the neck, and vertical zigzag lines on neck and shoulder. Rim chipped. Height 42.5. Floor.
 17. Red Polished III globular jug with round base; wide, concave neck, beaked mouth, and handle from rim to shoulder. Height 23.5. Floor.
 18. Red Polished II globular jug with cylindrical neck, splaying rim, and handle from neck to shoulder. Not complete. Floor.
 19. Red Polished II globular jug with tapering neck, splaying rim, and handle from neck to shoulder. Not complete. Floor.
 20. Red Polished II bowl as No. 7. Diam. 11.0. Floor.
 21. Red Polished II bowl as No. 7. Diam. 9.9. Floor.
 22. Red Polished II bowl as No. 7. A framed frieze of oblique lines below rim and above base; a framed band of parallel zigzag lines around body. Rim chipped. Diam. 11.0. Floor.
 23. Red Polished II jug as No. 13. No incisions. Height 11.6. Floor.
 24. Red Polished III pear-shaped jug with round base; cylindrical, narrow neck, splaying rim, handle from neck to shoulder, and a tubular spout opposite the handle. Height 25.0. Floor.
 25. Red Polished III pear-shaped jug with round base, backwards-curved neck, beaked mouth, handle from rim to shoulder; and a stringhole projection opposite the handle. Knob-ornaments on shoulder and neck. Height 26.2. Floor.
 26. Red Polished II incised jug as No. 1, but with a knobbed handle from neck to shoulder. Bands of horizontal lines and parallel zigzag lines around neck, and a rich decoration of parallel lines, zigzags, chevrons and concentric semicircles on body. Height 29.8. Floor.
 27. Red Polished II globular cooking-pot with round base; wide, concave neck, and one large and one small handle from rim to shoulder. Height 13.2. Floor.
 28. Red Polished III jug as No. 5. Height 59.5. Floor.
 29. Red Polished II jug as No. 1. Bands of horizontal lines around neck, and friezes of alternating concentric semicircles and semicircular hatched bands on body. Rim chipped; paint worn. Height 22.5. Floor.
 30. Red Polished II jug as No. 1. Bands of horizontal lines around neck, shoulder, belly and base, and two friezes of parallel zigzag lines on body. Surface much worn. Height 23.2. Floor.
 31. Red Polished III globular amphora with round base; cylindrical, wide neck, stilted rim, and two angular handles from neck to shoulder. Plain zigzag bands around neck, and hatched zigzag bands around shoulder. Height 20.9. Floor.
 32. Red Polished II pear-shaped jug with round base; tapering, convex neck, very wide funnel-rim, a vertical handle from rim to shoulder, and an angular, horizontal handle on the shoulder. Bands of oblong chess-board patterns of alternating hatched and plain rectangles, and a band of horizontal lines around neck and above base. The body is covered with a vertically arranged design of concentric lozenges; alternating concentric semicircles and hatched semicircular bands, and ribbons of oblong chess-board patterns as above. The horizontal handle is decorated with concentric circles, dots and hatched horizontal, vertical, and oblique bands. On the rim are concentric semicircles and radiating bands of oblong chess-board patterns. Surface partly much worn. Vertical handle missing. Height 38.5. Floor.
 33. Red Polished III globular amphora with base-knob, cylindrical neck, splaying rim, and two handles from neck to shoulder. Black mottled surface. Height 37.4. Floor.
 34. Red Polished II incised jug as No. 1; decorated as No. 30, but with friezes of hatched zigzag bands, and zigzag line on handle. Height 15.1. Floor.
 35. Red Polished II globular cooking-pot with round base, widening rim, and two elevated handles from rim to shoulder. Height 18.0. Floor.
 36. Red Polished II incised jug as No. 1. Height 15.1. Floor.
 37. Red Polished II amphora as No. 3, but with plain, angular handles. Height 27.4. Floor.
 38. Red Polished III globular cooking-pot with tripod base, wide neck, straight rim; one large and one small handle from rim to shoulder. Height 22.5. Floor.

39. Red Polished II bowl as No. 7. Diam. 13.6. Floor.
40. Red Polished II jug as No. 1, but with a knob opposite the handle. The body is covered with a skeuomorphic design of concentric circles joined by hatched bands in vertical, horizontal and oblique direction. Neck missing. Surface worn. Height c. 13.0. Floor.
41. Red Polished II bowl as No. 7. Diam. 13.0. Floor.
42. Black Polished incised biconical spindle-whirl with one flattened end. A hatched and dotted, horizontal zigzag band around the body. Diam. 3.7. Floor.
43. Red Polished II jug as No. 1; projection on shoulder. Neck and body are covered with a chess-board pattern of plain and hatched squares; a framed frieze of hatched lozenges above base. Damaged. Height 21.5. Floor.
44. Red Polished II oval jug with round base, tapering neck; wide funnel-rim, and handle from neck to shoulder. Pinched relief-lines on neck and shoulder. Neck and handle smashed. Paint worn. Height 55.5. Floor.
45. Red Polished III amphora; only fragments. Floor.
46. Red Polished II incised jug; only fragments. Floor.
47. Red Polished III jug as No. 25; spout on shoulder, and without knob-ornaments. Rim missing. Height 9.8. Floor.
48. Red Polished III pear-shaped bottle with round base, tapering neck, straight rim, and two holes below rim. Height 6.4. Floor.
49. Red Polished III miniature amphora, with widening neck, straight rim, and two handles from neck to shoulder. Base missing. Height 6.3. Floor.
50. Bronze sheet. Floor.
51. Two bronze pins with pointed ends; one with thickening top, but no distinct head, and a flat spiral around body; the other is plain with a small knob-head. Length 12.6; 9.3. Floor.
52. Two bronze pins similar to No. 51. Length 18.1; 18.5. Floor.
53. Four bronze pins similar to No. 51. Length 23.9; 22.5; 20.0; 18.2. Floor.
54. Two bronze pins similar to No. 51. Length 13.4; 10.8. Floor.
5. Red Polished biconical spindle-whirl with incisions. Not complete. Diam. 3.9. Floor.
6. Red Polished II globular jug with round base; tapering, cut-away neck, splaying rim, and handle from neck to shoulder. Three designs of goats in relief on the shoulder; snake-ornaments and pinched lines on neck. Shoulder-ornaments partly destroyed. Height 60.0. Floor.
7. Red Polished III pear-shaped jug with round base; narrow, cylindrical neck, high handle from base of neck to shoulder, and a tubular spout opposite the handle. Impressed, dotted stars on the body. Top of neck and rim missing. Height 16.2. Floor.
8. Red Polished II deep cooking-pot with round base, splaying rim, handle from rim to shoulder and a projection on the rim opposite the handle. Height 17.2. Floor.
9. Red Polished III globular amphora with flat base; cylindrical neck, flat rim, and two angular, small handles from neck to shoulder. Zigzag lines and impressed dots on neck and shoulder. Height 31.0. Floor.
10. Red Polished II tripod-pot; only fragments. Elaborate designs of crossed hatched zigzag bands, lozenge-bands, and parallel zigzag lines. Floor.
11. Red Polished II hemispherical bowl with a string-hole projection at the rim. Black rim and inside. Diam. 16.5. Floor.
12. Red Polished II bowl as No. 11; smashed. Diam. 13.9. Floor.
13. Red Polished II bowl as No. 11. Fragmentary. Diam. 11.9. Floor.
14. Red Polished II pear-shaped jug with round base. Concentric semicircles and short horizontal lines on body; paint worn. Neck and handle missing. Height 10.0. Floor.
15. Red Polished II jug; only fragments. Floor.
16. Red Polished II globular jug with round base, tapering neck, one large, knobbed handle from neck to shoulder and a smaller one opposite the other. Rim missing. Height 45.0. Floor.
17. Red Polished II bowl as No. 11. Decoration as No. 4, but interrupted, horizontal lines around rim. Piece of rim missing. Black rim and inside. Diam. 9.4. Floor.
18. Two bronze pins. 1) Straight pin with upwards thickening end and flattened head. Length 19.2.
2) Straight pin with small button-head. Length 20.2. Floor.
19. Red Polished II pear-shaped jug with round base, tapering neck, funnel rim and handle from rim to shoulder. Chess-board patterns on neck, and two framed friezes of parallel zigzag lines on body. Height 16.8. Found in No. 20.
20. Red Polished II bowl as No. 11. Diam. 14.8. Floor.
21. Red Polished II bowl as No. 11. Diam. 13.9. Floor.
22. Red Polished III globular jug with round base, backwards-curved neck; wide, beaked mouth, an incised handle from rim to shoulder, and a large string-hole projection opposite the handle. Fine, wavy string-ornament on neck and shoulder. Height 65.2. Floor.
23. Red Polished III globular jug with round base; tall, cylindrical neck, wide rim and handles as No. 22. Mi-

C h a m b e r B

1. Red Polished III globular amphora with round base; tall cylindrical neck; small, splaying rim, two knobbed, angular handles from neck to shoulder, and two square, horizontal handles on shoulder. Button- and snake-ornaments on neck and shoulder. Height 45.1. Floor.
2. Red Polished III globular jug with round base; wide, cylindrical neck; small, stilted rim, and handle from neck to shoulder. Height 47.8. Floor.
3. Red Polished II globular jug with round base; tall, tapering neck, wide rim, and handle from neck to shoulder. Pinched horizontal relief-lines on neck and shoulder. Paint partly worn. Height 61.5. Floor.
4. Red Polished II hemispherical bowl with a string-hole projection at rim. A frieze of framed, oblique lines below rim, and parallel zigzag lines around body. Even red. Diam. 10.0. Floor.

- nute, horizontal string-ornaments around neck and shoulder. Height 60.3. Floor.
24. Red Polished III amphora as No. 1. Vertical zigzags and impressed dots on neck and handles. Height 49.5. Floor.
25. Red Polished II bowl as No. 4. Piece of rim missing. Diam. 11.4. Floor.
26. Red Polished III jug as No. 2, but with slightly convex neck. Height 51.0. Floor.
27. Red Polished III hemispherical bowl with four, hooked projections on rim. A herring-bone band around rim, and two friezes of irregular zigzag bands around body. Even red. Diam. 18.6. Floor.
28. Red Polished III bowl as No. 11. Hatched lozenges around rim, and on body. Irregular pattern. Black rim and inside. Diam. 11.0. Floor.
29. Red Polished III bowl as No. 11. Decorated as No. 4, but with a herring-bone band below rim. Black rim and inside. Diam. 9.7. Floor.
30. Red Polished II bowl as No. 11. Parallel zigzag lines around rim, and hatched lozenges around body. Diam. 10.8. Floor.
31. Red Polished II bowl as No. 11. A framed zigzag line below rim, and parallel zigzag bands around body. Diam. 11.2. Floor.
32. Red Polished II jug as No. 19, but with shorter neck, and a projection opposite the handle. Horizontal bands of parallel lines around neck; concentric circles, oblique lines, zigzags and herring-bone elements on body. Height 20.5. Floor.
33. Fragments of a Red Polished II jug, similar to No. 32. Floor.
34. Red Polished II bowl as No. 11. Rim chipped. Diam. 15.0. Floor.
35. Red Polished III depressed, roughly biconical pyxis with inwards-tapering sides, oval mouth without real rim, and two elevated ridges from ends of mouth to belly. String-holes through ridges and rim. The pot suggests a prototype of leather. Height 19.0. Floor.
36. Red Polished II jug as No. 3. Height 57.5. Floor.
37. Red Polished II bowl as No. 17. Framed, parallel zigzag lines below rim; body covered with vertical framed zigzags and oblique parallel lines in various patterns. Diam. 11.9. Floor.
38. Red Polished II bowl as No. 11. Smashed. Diam. 10.5. Floor.
39. Red Polished III hemispherical bowl. A framed zigzag line below rim; vertical, concentric semicircles and hatched lozenges on body. Even red. Diam. 10.5. Floor.
40. Red Polished II globular jug with wide, tapering neck, splaying rim, and handle from neck to shoulder. Not complete. Height c. 55.0. Floor.
41. Black Polished bottle with flat base. Vertical, framed herring-bone bands on body. Neck missing; surface worn. Height 7.2. Floor.
42. Red Polished III globular jug with round base, cylindrical neck; curved, beaked mouth, and handles as No. 22. Vertical zigzag lines on neck, and oblique, parallel lines on the shoulder opposite the handle. Height 34.5. Floor.
43. Red Polished conical spindle-whirl with incisions. Diam. 4.3. Floor.
44. Two bronze pins. 1) Straight pin with small button-head. Length 15.4. Floor.
2) Straight pin with round head. Length 14.6. Floor.
45. Red Polished, conical spindle-whirl with incisions. Diam. 4.7. Floor.

A summary of the classification of the finds in the two chambers gives the following diagram:

	P o t t e r y			B r o n z e		T e r r a c o t t a	
	R. P. II	R. P. III	Bl. P.	Pins	Sheet	Spindle-whirl	Idol
Chamber A	1, 3, 6, 7, 8 10, 13, 18, 19, 20 21, 22, 23, 26, 27 29, 30, 32, 34, 35 36, 37, 39, 40, 41 43, 44, 46 -28	2, 4, 5, 9, 14 15, 16, 17, 24, 25 28, 31, 33, 38, 45 47, 48, 49 -18		12, 12 51, 51 52, 52 53, 53 53, 53 54, 54 -12	50 -1	42 -1	11 -1
Chamber B	3, 4, 6, 8, 10 11, 12, 13, 14, 15 16, 17, 19, 20, 21 25, 30, 31, 32, 33 34, 36, 37, 38, 40 43 -26	1, 2, 7, 9, 22 23, 24, 26, 27, 28 29, 35, 39, 42 -14	41 -1	18, 18 44, 44 -4		5, 43, 45 -3	

CHRONOLOGY

The proportion between the two classes of the Red Polished Ware in the tomb is approximately the same in both chambers and they have, to judge from their contents, both to be dated to the beginning of the E. C. III period. The presence, however, of the destroyed bottom layer in Chamber A shows that this chamber already existed in the previous period. All the pots of the Red Polished III class are early in shape with a few exceptions (Chamber A, Nos. 24 and 47; Chamber B, No. 7). Their bright lustrous surface and their fine manufacture are, too, indications of their relatively early date.

TOMB 310 (Fig. 37: 2—3)

This tomb was already excavated, when found by us, a fact clearly visible from the commencement of the work; but the excavation was carried through in order to get a complete plan. Below follows a short description:

	SIZE			
	Length	Width	Depth	Height
Dromos	2.08	1.42	1.19	—
Stomion	0.70	0.58	—	0.55
Chamber	2.60	3.78	—	1.15

SHAPE

The dromos is bucket-shaped with almost vertical long sides: an oblique, semicircular end, and slightly sloping floor. The stomion is narrow and tunnel-shaped with a single, perpendicular step, leading down to the level of the chamber. The chamber was oval with one niche at the W. side, raised about 0.25 m. above the floor. The floor was horizontal; roof and walls formed a low vault, and the tomb was well preserved.

TOMB 311 (Figs. 30; 36; 37: 4—6; 38: 1—2)

	SIZE			
	Length	Width	Depth	Height
Dromos	3.41	1.71	1.67	—
Stomion A	0.77	0.76	—	0.52
Chamber A.....	3.17	3.88	—	1.42
Stomion B	0.74	0.79	—	0.54
Chamber B.....	2.63	2.92	—	1.18

SHAPE

The dromos is of unusually large size. Its shape, too, differs slightly from the dromoi of the previously described tombs. The floor rises towards the semicircular end of the dromos, where it forms a step near the back wall. On the surface of the rock in the same

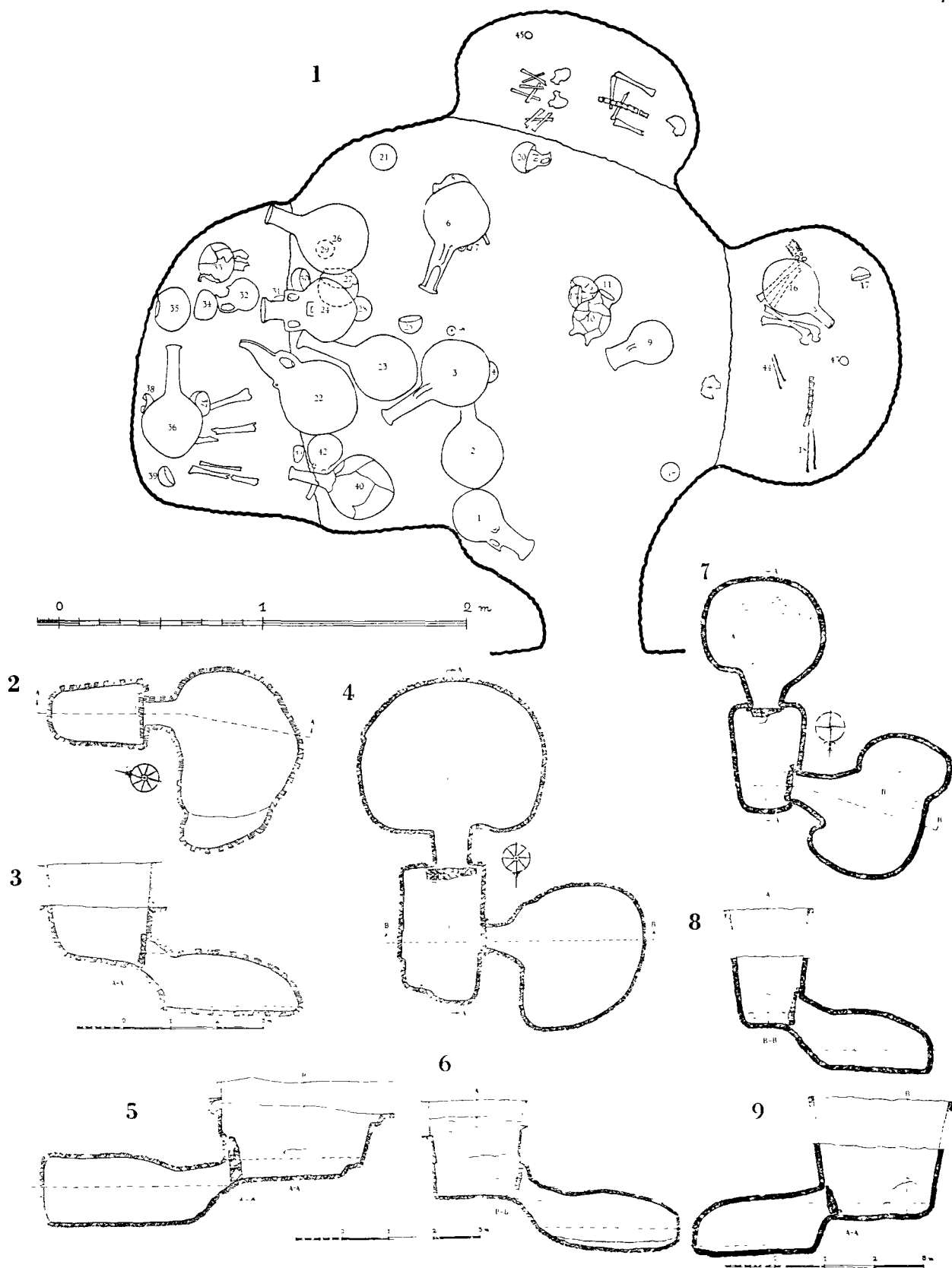

Fig. 37. Lapithos. Tomb 309 B, Finds *in situ* (1). Tomb 310, Plan (2); Section A-A (3). Tomb 311, Plan (4); Sections A-A, B-B (5, 6). Tomb 312, Plan (7); Sections B-B, A-A (8, 9).

part of the dromos was another shallow cutting which formed a sort of a step, leading down to the lower level.

The dromos is very well cut, the corners were sharply defined and the walls tapered regularly downwards. Two chambers opened on to the dromos, one from the S. side — Chamber A — and one from the long W. side — Chamber B. Opposite the latter was a shallow, square cutting, evidently the beginnings of an intended, but never completed, third chamber. Just below the surface of the rock, above the entrance to Chamber A were two small cupboards cut in the rock and closed by flat, circular stones, sunk in the face of the dromos.

Chamber A was blocked up by a single slab, kept in position by several small stones, and a narrow sloping passage leads down to the chamber. The tomb is symmetrically cut with a horizontal floor, an almost vertical back wall and a flat roof. The plan is oval or slightly “kidney-shaped” without niches.

Chamber B much resembled the above described tomb: the door stone, however, was framed by a cornice, sunk into the face of the wall, and the chamber itself is an irregular oval with an outward bulging N. side.

STRATIFICATION

The *chavara*, filling the dromos was homogeneous and without any distinct stratification, which is proof that no partial excavation had been carried out in connection with the repeated burials in the tomb. The contents of the chambers clearly demonstrate that the burials could not all have been simultaneous, which leads us to the conclusion that the dromos had either been left open until the last burial had taken place, or entirely excavated between each burial. The former hypothesis is preferable in view of the fact that the cupboards of the dromos were plundered, and that the short, front wall of the dromos was found in a condition evidently not the original one. It has been retouched by later cuttings so that its upper part lies in a receding plane, and the façade of the tomb has been kept smooth. The reason that the dromos was so specially cared for seems to lie in the fact that it was exposed to the eyes of the passers-by. Perhaps the square cutting opposite Chamber B can be interpreted as a blind door, placed there, in order to give a symmetrical effect to the dromos.

To distribute the tomb-gifts of Chamber A among the four different burials found, is very difficult because of the lack of stratigraphical evidence. All the finds lay directly on the floor, and did not surround the bodies in the usual way. Thus, the bulk of the large pots were found to the right of the door, where no skeleton lay. It had evidently served as a common deposit, and contained, as a matter of fact, pottery of very varying dates. The same can be said of a heap of small pots near the back wall, where only scanty remains of a single skeleton were found. The other bodies lay in the E. part of the chamber with comparatively few pots in their immediate neighbourhood.

In Chamber B the finds were arranged in the usual way, round the skeletons, which were three in number, all resting directly on the floor. To decide the chronological order between the three burials does not seem possible.

BURIALS

In Chamber A the evidence, given by the skeletal remains, indicates that the habit of placing the dead bodies in a squatting position was the rule. The diverging femora on both sides of a pelvis make this position undoubted in one case, and the other skeletons with converging tibiae, crossed femora and tibiae, and skulls close to the pelvis, also indicate a similar position.

Chamber B contained only remains of skeleton of non-adult people. The body of a small child had been placed on some large pithos-sherds to the right of the entrance, and near the back wall were found scanty remains of two bodies. The size and structure of the latter show, that they, too, belonged to children. The absence of bronze tools among the burial gifts, evidently, depends on this circumstance.

FINDS (GROUPS: PL. XXII; TYPES: L. OF PL. II)

Chamber A

1. Red Polished III hemispherical bowl with a string-hole projection at rim. Black rim and inside. Horizontal lines around rim; body covered with an irregular decoration of concentric circles, zigzags, ladder-patterns, hatched lozenges and straight lines. Half the bowl is missing. Floor.
2. Red Polished II pear-shaped jug with round base. Friezes of zigzag lines around shoulder and above base; concentric circles, hatched and latticed bands, and hatched lozenges around belly. Neck and handle missing. Much damaged. Floor.
3. The body of a Red Polished II oval jug with round base. Height 47.1. Floor.
4. White Painted III squat jug with round base, cylindrical neck, beaked mouth, and handle from rim to shoulder. Wavy lines around neck and on handle; broad bands of network pattern from neck to base, and vertical, wavy lines in the interstices. Height 17.8. Floor.
5. Red Polished II hemispherical bowl with a string-hole projection at rim. Diam. 12.8. Floor.
6. Red Polished III pear-shaped jug with round base, cylindrical neck, stilted rim, and an incised handle from neck to shoulder. Height 47.8. Floor.
7. Red Polished III oval jug with round, pointed base; cylindrical cut-away neck, and handle from neck to shoulder. Height 21.5. Floor.
8. Red Polished II globular jug with round base; slightly concave, cut-away neck, and handle from neck to shoulder. Fragmentary. Height 49.5. Floor.
9. White Painted II pear-shaped jug with round base, backwards-curved neck, beaked mouth, handle from rim to shoulder, and a string-hole projection opposite the handle. Straight, wavy, and zigzag lines around neck, and broad vertical bands of network patterns with wavy lines in their interstices from neck to base; an encircled cross on base. Rim chipped. Height 26.7. Floor.
10. Red Polished II globular jug with round base; tall, narrow neck, and handle from neck to shoulder. Button-ornaments and relief-lines on neck and shoulder. Rim and upper part of neck missing. Height 46.0. Floor.
11. Red Polished II bowl as No. 5. A frieze of hatched lozenges below rim, and a band of parallel zigzag lines with concentric circles and oblique lines in the angular interstices. Black rim and inside. Diam. 16.8. Floor.
12. White Painted II jug as No. 9, but with red painted base. Height 32.5. Floor.
13. White Painted II jug as No. 12. Height 31.5. Floor.
14. Red Polished III jug as No. 6. Height 35.5. Floor.
15. Red Polished III shallow bowl with round base and a string-hole projection at rim. Almost flat surface. Diam. 13.7. Floor.
16. Red Polished II depressed globular jug with round base; wide, convex neck, splaying rim, and handle from neck to shoulder. Rim chipped. Height 49.7. Floor.
17. Fragments of a Red Polished II jar. Floor.
18. Red Polished II bowl as No. 5. Diam. 11.5. Floor.
19. Red Polished II globular jug with round base; tall, tapering neck, splaying rim, and handle from neck to shoulder. Ornaments of buttons and pinched lines in relief on neck and shoulder. Height 29.3. Floor.
20. Red Polished II jug as No. 19. Height 53.2. Floor.
21. Red Polished II bowl as No. 5. Diam. 13.6. Floor.
22. White Painted III globular jug with concave narrow neck, slightly oblique mouth, and handle from rim to shoulder. Horizontal lines around neck, and two friezes of hatched triangles on body. A framed, vertical, wavy line as front ornament, and zigzags on handle. Height 15.2. Floor.
23. Red Polished II bowl as No. 5. Diam. 12.3. Floor.
24. Red Polished II globular amphora with flattened base, wide neck, splaying rim, and two angular handles from neck to shoulder. Fragmentary. Floor.
25. Red Polished III globular cooking-pot with flattened base, splaying rim, and one large and one small handle from rim to shoulder. Height 12.5. Floor.
26. White Painted III shallow bowl with round base, and a high vertical handle below rim. Bands of oblique, parallel

- lines around rim; bands of parallel lines, meeting two wavy lines in a cross outside the base; an interior decoration of a cross ornament, radiating from a central dot, with horizontal, wavy lines in the angular interstices. Transverse lines on handle. Diam. 8.2. Floor.
27. White Painted II globular jug with round base, concave neck, oblique mouth, and an elevated handle from rim to shoulder. Decoration as No. 9, but with an encircled dot on base. Handle missing. Height 18.5. Floor.
28. Red Polished II bowl as No. 5. Diam. 16.2. Floor.
29. Bronze tweezer with flat arms and rounded top. Broken into two pieces. Length 6.7. Floor.
30. White Painted II bowl as No. 26, but with a horizontal handle below rim. Bands of oblique, parallel lines around rim, and a similar band from base of handle to the opposite rim; straight lines on handle, and on both sides of the central base band. Diam. 12.4. Floor.
31. White Painted III globular amphora with flattened base; cylindrical, wide neck, stilted rim, and two knobbed handles from neck to shoulder. Framed friezes of parallel and partly crossed zigzag lines around neck and above base; hatched, vertical bands below the handles, and lattice-triangles and lozenges arranged in friezes around body. Height 18.5. Floor.
32. Red Polished depressed spherical spindle-whirl with incisions. Diam. 3.8. Floor.
33. Thin, plain bronze pin with pointed end. Length 8.55. Floor.
34. Red Polished III hemispherical bowl with a string-hole projection at the rim. Even red. Diam. 12.0. Floor.
35. White Painted III globular jug with round base, slightly convex neck, trefoil-lip, and an elevated handle from rim to shoulder. Decoration as No. 4. Height 10.1. Floor.
36. White Painted III bowl as No. 30. Bands of oblique, parallel lines around rim, and a broad band of the same pattern from base of handle to the opposite rim. The segments are filled with wavy lines, flanked by circles; concentric, wavy lines inside. Handle missing. Diam. 10.2. Floor.
37. Red Polished III ovoid bottle with round base, cylindrical neck, splaying rim, and a small, angular handle from neck to shoulder. Height 9.5. Floor.
38. Red Polished III roughly made, globular miniature jug with round base, beaked mouth, and handle from rim to shoulder. Height 6.2. Floor.
39. Red Polished III jug as No. 38. Height 7.2. Floor.
40. Black Polished oblong bottle with flat base, tall, cylindrical neck, and a small handle from rim to neck. Rim deformed. Straight lines framing a zigzag line around neck, and two framed friezes of hatched lozenges around body. Height 5.1. Floor.
41. Red Polished III jug as No. 14. Height 24.0. Floor.
42. Leaf-shaped bronze knife with pointed end, convex sides, midrib, two edges, and tapering top with one rivet-hole. Length 16.4. Floor.
43. Straight, thin bronze pin with pointed end. Length 6.2. Floor.
44. Red Polished III jug as No. 38, but with straight mouth. Height 6.7. Floor.
45. Red Polished II jug as No. 10. Damaged. Height 44.5. Floor.
46. Red Polished III jug as No. 6; upper part of neck missing. Height 26.5. Floor.
47. Leaf-shaped bronze knife with rounded end, concave sides, two edges, midrib, and wide, rounded top with three rivets. Length 13.3. Floor.
48. Piece of a ring of silver-lead. Floor.

C h a m b e r B

1. Red Polished II hemispherical bowl with a string-hole projection at rim. Damaged. Diam. 14.0. Floor.
2. Red Polished II oval jug with slightly concave neck; narrow, flattened base, splaying rim, and handle from neck to shoulder. Paint worn. Height 35.2. Floor.
3. Red Polished II globular jug with tapering, cut-away neck, and a handle from neck to shoulder. Paint partly worn. Height 49.2. Floor.
4. Red Polished II bowl as No. 1. Diam. 12.8. Floor.
5. Red Polished III globular cooking-pot with round base, wide mouth, an angular, elevated handle from rim to body, and a string-hole projection opposite the handle. Height 15.7. Floor.
6. Red Polished III pear-shaped jug with round base, cylindrical, cut-away neck, and handle from neck to shoulder. Damaged. Height 23.7. Floor.
7. Red Polished II jug as No. 3. Height 44.5. Floor.
8. Red Polished III oval jug with round base; cylindrical, cut-away neck, and handle from neck to shoulder. Height 28.2. Floor.
9. Red Polished II bowl as No. 1. Diam. 14.2. Floor.
10. Red Polished II jug as No. 2. Damaged. Height 33.1. Floor.
11. Red Polished II bowl as No. 1. Fragmentary. Diam. 13.6. Floor.
12. Red Polished II bowl as No. 1; rim chipped. Diam. 13.6. Floor.
13. Red Polished II jug as No. 2. Height 35.7. Floor.
14. Black Polished pear-shaped bottle with round base, and tall, tapering neck. Rim missing. Red mottled spots at the base. Horizontal lines and concentric semicircles around neck; a skeuomorphic design of concentric circles connected by horizontal and oblique bands of parallel lines covering the body. Height 13.2. Floor.
15. Red Polished II oval amphora with narrow, flat base; wide, concave neck, splaying rim, and two handles from neck to shoulder. Rim chipped. Height 33.8. Floor.
16. Red Polished II pear-shaped jug with round base; shoulder, neck, rim and handle missing. Decorated as No. 14. Floor.
17. Fragments of a Red Polished II jug as No. 3. Floor.

- 18. Fragments of a Red Polished II pear-shaped jug with round base, handle from neck to shoulder, and a projection opposite the handle. Floor.
- 19. Black Polished globular bottle with wide, bulging neck, splaying rim, and two knobs on the shoulder. Partly red mottled. Friezes of parallel zigzag lines and dotted lozenges cover neck and body; a horizontal dotted line between neck and body, and hanging dotted lozenges below the handles. Height 16.0. Floor.
- 20. Red Polished II bowl as No. 1. Rim chipped. Diam. 13.7. Floor.
- 21. Red Polished II bowl as No. 1. Diam. 13.0. Floor.

The diagram serves as a summary of the Object Register.

	P o t t e r y					B r o n z e			Silver-lead	Terracotta
	R. P. II	R. P. III	Wh. P. II	Wh. P. III	Bl. P.	Knives	Tweezer	Pins	Ring	Spindle-whirl
Chamber A	2, 3, 5, 8 10, 11, 16, 17 18, 19, 20, 21 23, 24, 28, 45 -16	1, 6, 7 14, 15, 25 34, 37, 38 39, 41, 44 46 -13	9, 12 13, 27 30 -5	4, 22, 26 31, 35, 36 -6	40 -1	42, 47 -2	29 -1	33 43 -2	48 -1	32 -1
Chamber B	1, 2, 3, 4 7, 9, 10, 11 12, 13, 15, 16 17, 18, 20, 21 -16	5, 6, 8 -3			14, 19 -2					

CHRONOLOGY

The distribution of the different wares in the chambers shows that Chamber B contained the older pottery. Analysing the contents of this chamber, we find that a good many of the Red Polished II vases are of early types. The jugs Nos. 3, 7 and 17, and the amphora No. 15 must especially be pointed out as being specimens of a transitional style between Red Polished I and II shapes. The few pots of the Red Polished III class are, too, of relatively early types. Thus, the typical, coarse zigzag incisions are not represented in any case, and the surface of the vases are well polished. The Black Polished pots Nos. 14 and 19 represent the most advanced shapes in the chamber.

Chamber B shows a mixture of wares and styles of very different dates, but the situation in the tomb does not allow any certain attribution of the earlier and the later pottery. All the White Painted III Ware, except No. 4 is, however, concentrated in a group in the neighbourhood of some skeletal remains, which makes it reasonable to suppose that they belong to the latest burial. From the point of view of construction it is, of course, impossible to place the cutting of Chamber B at an earlier date than the central chamber. As Chamber B is safely dated to an early stage of E. C. II and has been used up to the beginning of E. C. III, Chamber A was also cut in E. C. II. No intact group of finds, dateable to this period, was found in the chamber, but some could have belonged to such a group. The early Red Polished II Ware is represented by the jugs Nos. 8, 19, 20, the amphora No. 24, and some of the bowls, but this group has been dispersed by the later arrangements in the chamber.

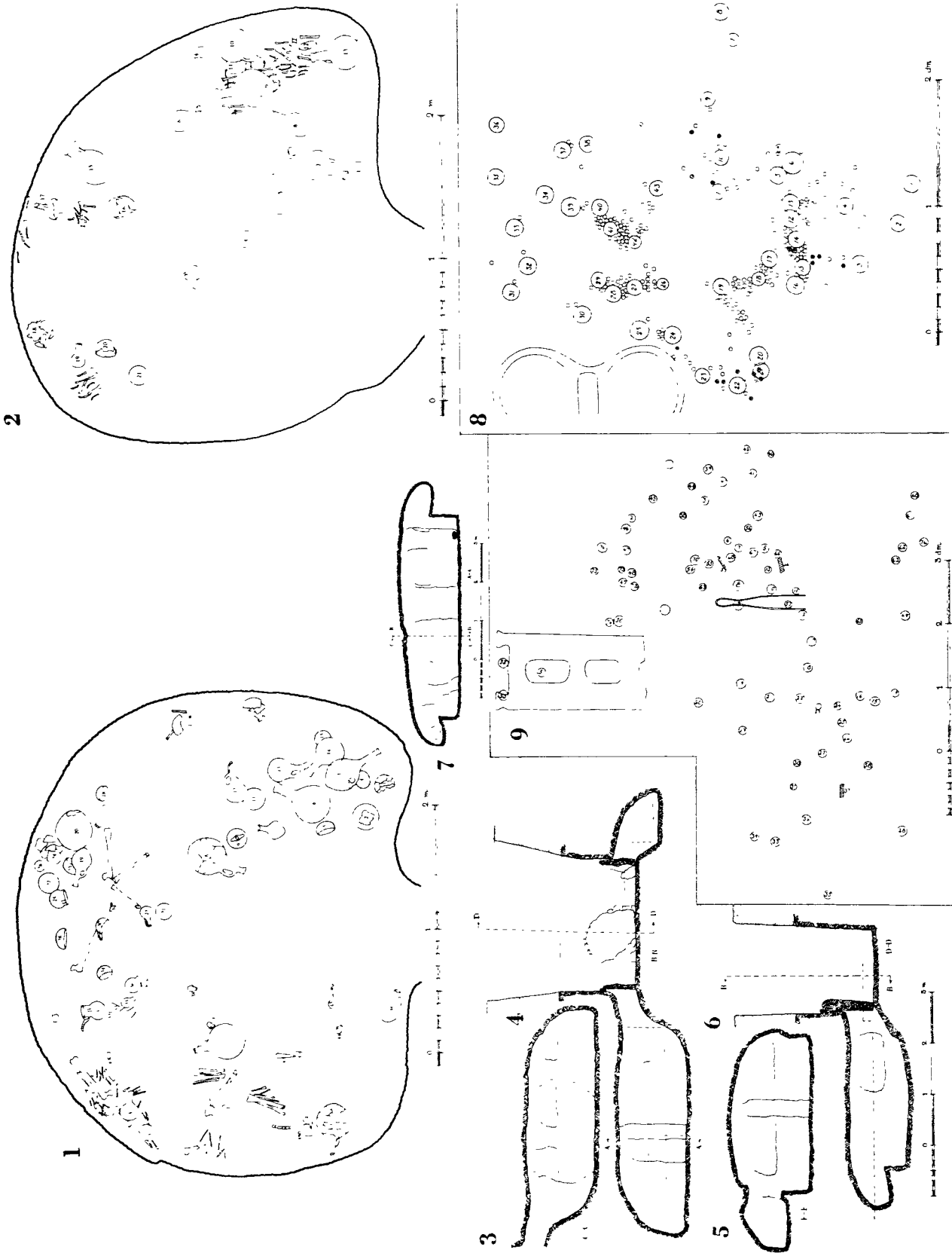

Fig. 38. Lapithos. Tomb 311 A-B, Finds *in situ* (1, 2). Tomb 313, Sections C-C, B-B, E-E, D-D, A-A (3, 4, 5, 6, 7); Necklaces Nos. 78 and 32 + 42 + 44 *in situ* in Tomb 313 B *in situ* (8, 9).

The latest finds are the vases belonging to the White Painted III class, and they date the last burial in the chamber to the M. C. I period. It is certainly remarkable that a tomb, which has been used from E. C. II to M. C. I only contained seven bodies, three of which were children. The lack of stratification in the central chamber equally astonishing. The intervals between the burials must have been very long, and rearrangements considerable. Hence the heterogeneous character of the contents, and the difficulties connected with the distribution of the finds.

TOMB 312 (Figs. 37: 7—9; 39)

	SIZE			
	Length	Width	Depth	Height
Dromos	2.40	1.42	1.42	—
Stomion A	0.55	0.79	—	0.55
Chamber A.....	2.03	2.33	—	1.04
Stomion B	1.01	0.76	—	0.58
Chamber B.....	1.64	2.95	—	1.09

SHAPE

The dromos is bucket-shaped with sides tapering downwards, and an almost horizontal floor. There were two tombs cut from the dromos, one from the short, front side — Chamber A — and one from the long W. side, close to the semicircular back wall — Chamber B. Both were closed by single blocks, wedged with smaller stones. Chamber A has a stomion widening inwards, and a roughly circular chamber with horizontal floor, low, curved roof, and no niches. The entrance to Chamber B is of the same type as that of Chamber A, with a steep slope from the door down to the level of the floor. The chamber is almost “kidney-shaped” with two bulging recesses in the short sides. The longitudinal axis of the stomion and chamber diverges in an obtuse angle from that of the dromos, evidently to avoid a collision between the S. part of the chamber and the W. side of the dromos. The irregularities in the shape of the chamber depend on the same circumstance.

STRATIFICATION

The stratigraphy of the tomb was very simple. The dromos was filled with *chavara*, divided into two layers. The lower which was hard packed, was confined to the region in front of the entrance to Chamber A, and was only about 0.20 m. thick; the upper filled the rest of the space. The dromos-filling proves that the dromos has been partly dug out at least once, in connection with a secondary burial, and the small stratum close to the door of Chamber A must be considered as an intact remainder of the original filling matter.



Fig. 39. Lapithos. Tomb 312 A. Interior view with finds *in situ*.



Fig. 40. Lapithos. Tomb 313, dromos.

Proceeding into Chamber A, we found a perfectly intact and very well preserved tomb. No earth covered the finds or skeletons, and the tomb-gifts rested directly on the floor. Two burials could be traced, one along the E. wall with Finds Nos. 1, 5, 6 and 7, and another in the S. W. corner, to which Nos. 2, 3 and 4 belonged. To judge from the state of preservation of skeletons and finds, the former burial should be considered the older of the two.

Chamber B contained only one body, found in the S. recess together with two pots. The tomb, as a whole, was very poor.

BURIALS

The older skeleton in Chamber A was too badly damaged to allow of any certain conclusions being drawn as regards the burial customs. It had turned to dust except for some fragments of the spinal column, which were found lying in a row parallel with the longitudinal axis of the chamber. An analysis of the remains of the later burial indicates that the dead body was placed in the tomb in a squatting position, near the back wall and facing the door. The angle between the femora and a piece of a tibia seem to be incompatible with any other position. With the gradual decomposition, the upper part of the body has fallen to the left, where some fragments of ribs and humeri were found.

In Chamber B the only skeleton found was too badly preserved to be studied. Some fragments of the skeleton of a sheep are of interest: they were found close to the human remains and are evidently remnants of a funeral meal.

FINDS (GROUP: PL. XXIII, I)

Chamber A

- | | |
|---|--|
| <p>1. Red Polished II globular jug with rounded, pointed base; tapering, cut-away neck, and handle from neck to shoulder.</p> | <p>der. Button-ornaments on neck and shoulder. Height 52 o. Floor.</p> <p>2. Red Polished II jug with wide, cylindrical neck, splaying</p> |
|---|--|

- rim, and handle from neck to shoulder. Button-ornaments at top of handle. Damaged. Height 49.2. Floor.
3. Red Polished II globular jug with round base; tall, tapering neck, and handle from neck to shoulder. Pinched relief-lines on neck and shoulder. Rim missing. Height 48.0. Floor.
 4. Red Polished II jug as No. 3. Damaged. Height 54.2. Floor.
 5. Red Polished II hemispherical bowl with a string-hole projection at rim. Diam. 14.0. Floor.
 6. Red Polished II globular amphora with round base, sharply splaying rim, and two small, vertical handles on

- shoulders. Bands of horizontal lines around rim, shoulder and base, and a frieze of concentric circles joined by parallel horizontal lines around belly. Height 14.5. Floor.
7. Fragments of a Red Polished II bowl as No. 5. Floor.

C h a m b e r B

1. Red Polished II large globular jug with round base, cylindrical neck, splaying rim, and handle from neck to shoulder. Base missing. Height 47.0. Floor.
2. Red Polished I deep hemispherical bowl with a double projection at rim. Diam. 14.2. Floor.

Summing up the results of the stratigraphical analysis and the description of the finds, we obtain the following diagram:

P o t t e r y		
	R. P. I	R. P. II
Chamber A 1st burial		1, 5, 6, 7 -4
Chamber A 2nd burial		2, 3, 4 -3
Chamber B	2 -1	1 -1

C H R O N O L O G Y

Vase No. 1 in Chamber A is of the early pattern with the typical "cut-away" neck found in Tombs 303, 308 and 311 B. The rest of the pottery in the chamber are good specimens of the Red Polished II class, but the bowl in Chamber B must be classified as a Red Polished I specimen. Consequently, we can date the first burial in Chamber A and the burial in Chamber B to the very beginning of E. C. II; and the second burial in Chamber A to a somewhat later part of the same period.

T O M B 3 1 3 (Figs. 38: 3—9; 40—43)

	S I Z E			
	Length	Width	Depth	Height
Dromos	2.66	1.73	1.44	—
Stomion A	0.85	1.10	—	0.42
Chamber A.....	3.90	6.79	—	1.34
Stomion B	0.28	0.86	—	0.55
Chamber B.....	3.50	4.05	—	1.17
Stomion C	0.15	0.50	—	0.43
Chamber C.....	1.10	1.07	—	0.75
Stomion D	0.34	0.62	—	0.45
Chamber D	2.11	2.64	—	0.96

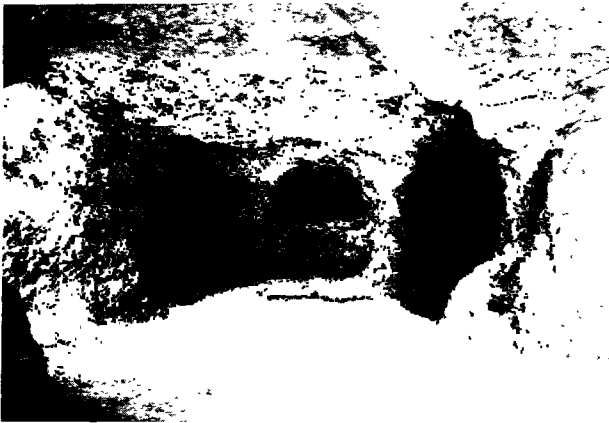

Fig. 41. Lapithos. Tomb 313 A. Interior view.



Fig. 42. Lapithos. Tomb 313 A. Interior view.

SHAPE

The shape of this tomb shows the latest development of the main tomb-type, characteristic to this necropolis. In design, there is no difference between Tomb 313 and the other tombs, but all the constructive and architectural details, which in the rest of the tombs are vaguely indicated, are here emphasised, especially in the structure of Chamber A. That chamber can be considered as the ideal result of a gradual development, which practically cannot be advanced without loosing the essential features of the type.

The dromos is large and bucket-shaped with perpendicular sides and horizontal floor. Four chambers belong to the tomb. The principal chamber — Chamber A — opens from the short, front side of the dromos; Chamber B from the long W. side, and Chambers C and D, which can be considered as one, from the semicircular end opposite Chamber A.

The plan of Chamber A is roughly symmetrical with a widening and sloping stomion, a central square projection opposite the entrance, and three raised niches on both sides of the central axis. The projecting piece of rock serves as a column, supporting the vaulted roof, and the series of niches produce a similar effect, preventing the spacious chamber from falling in.

Chamber B is oval with two, irregularly placed, raised niches. The N. niche is involuntarily connected with Chamber C by the collapse of the thin, separating wall.

Chamber C is a small circular tomb with a hole through its E. wall, leading into the niche of Chamber D. The traces of the cutter's tools show that this connection was purposely established. Finally Chamber D is a small, oblong room with a semicircular niche above the level of the floor.

All the niches in the chambers are cut in a similar manner, so that the deepest part of the niche is close to the back wall; and in front, there is a low partition next the chamber.

The whole complex of tombs with a maximum length of 10.60 m. forms an ingenious series, whereby the utmost space is obtained without disregarding the demands of constructive stability. The E. side of the dromos could not be used for a fifth chamber as the ground declines too rapidly to the East.

A small sack-shaped cupboard with circular opening was found above the door of the principal chamber.

STRATIFICATION

The dromos-filling consisted of *chavara* mixed with potsherds, decreasing in number towards the bottom. The dromos must have been emptied and filled many times in connection with the different burials in the tomb, and the large number of fragments of pottery shows that the chambers also have been deprived of some of the damaged deposits.

In the central part of Chamber A was found a 0.30 m. deep layer of debris fallen from the roof: it covered the floor in a low heap. The niches and the back part of the chamber were perfectly clear.

To distribute of the finds among the different burials, it is necessary, first, to state how many burials had taken place in the chamber. An examination of the remains gives the following result. In each niche was one skeleton, numbered, like the niches, from left to right 1—6. Below the niches 1, 2, 3, 4, and 6 were traces of other burials, numbered 7, 8, 9, 10, and 11. Close to No. 11 lay a baby's skeleton, No. 12; and in the central area were three other skeletons Nos. 13, 14, and 15. The sketch shows their positions.

It is clear without further comment, that

- No. 1 is older than No. 7;
- No. 2 older than No. 8;
- No. 3 older than No. 9;
- No. 4 older than No. 10;
- No. 6 older than Nos. 11 and 12;
- Nos. 7 and 8 older than No. 13;
- Nos. 3 and 9 older than No. 14;
- Nos. 10, 11 and 12 older than No. 15.

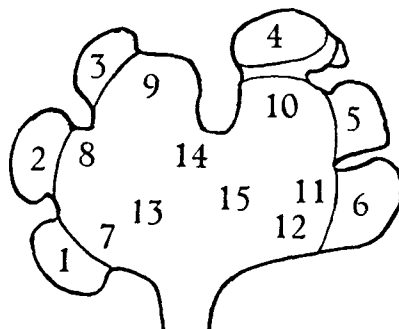

This sequence is confirmed by the dispositions in the chamber. It seems also reasonable to suppose that the niches were used in the first place as originally intended, that is to say Nos. 1—6 are older than Nos. 7—15. Following the same burial series, the whole of the group, 7—12, ought to be older than Nos. 13—15, and we, consequently, should be able to divide the fifteen burials into three groups, which can be arranged in the following relative chronology:

1. Burials Nos. 1—6.
2. Burials Nos. 7—12.
3. Burials Nos. 13—15.

As all the finds and the skeletal remains were found directly on the floor, the only criterion for the distribution of the finds between the three burial groups is their position in the chamber; but it does not seem probable that any essential rearrangement of the deposits has taken place during the time when the tomb was in use, and, with reservations for such a case, the finds can be attributed to the burial groups as follows:

The finds Nos. 56, 66—70 and 73—118 belong to the first group; Nos. 1—12, 40—44, 71,

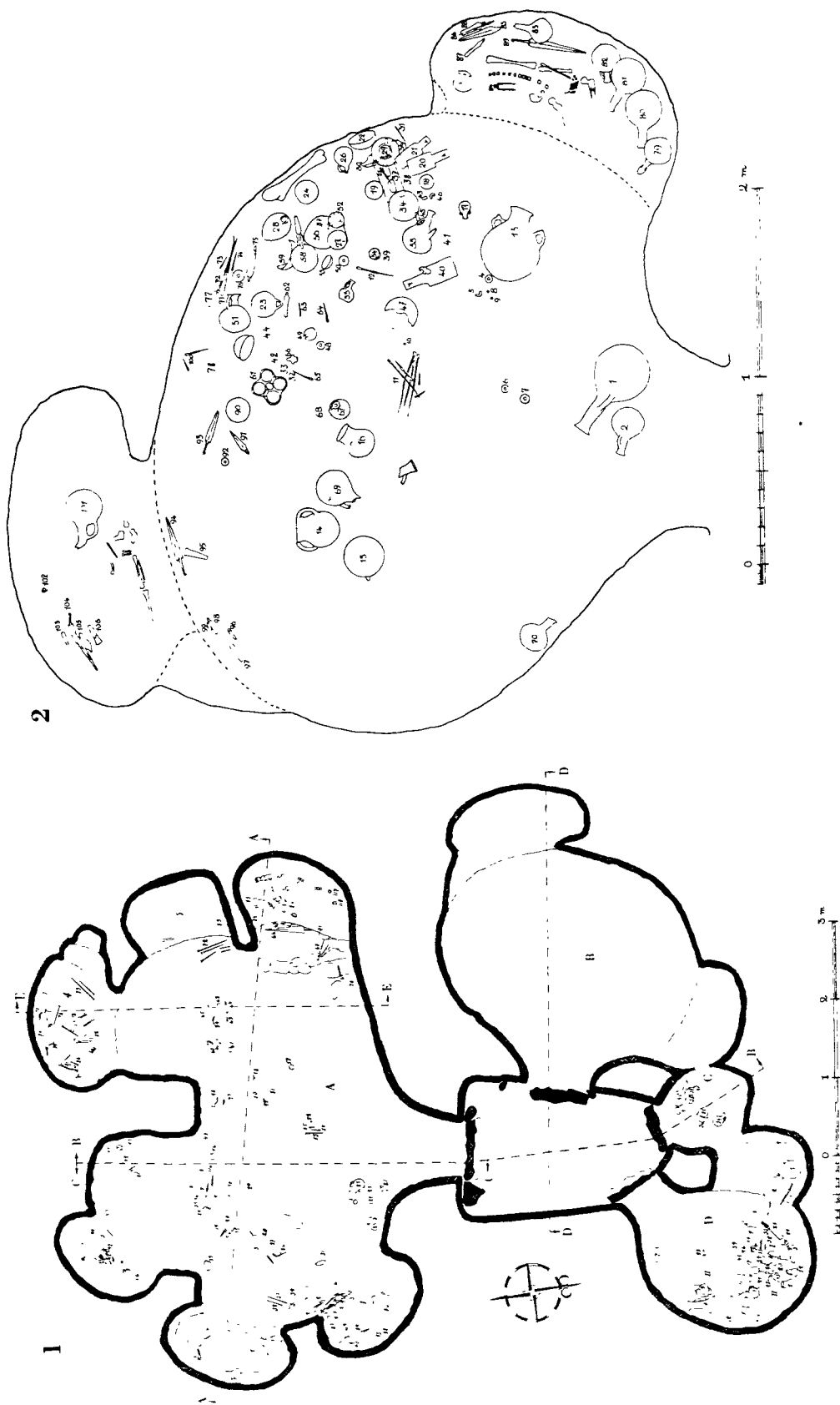

Fig. 43. Lapithos. Tomb 313, Plan (1); Chamber B, finds *in situ* (2).

and 72 to the second group; and Nos. 13—39, 45—55, and 57—65 to the third group. The bulk of the finds were bronzes.

Chamber B was, too, well preserved. Only in the S. part of the chamber, had pieces of the roof fallen and covered the finds. The chamber has been stratified in two layers, but water has poured in through the door and disturbed the original levels of the deposits. Consequently, it is dangerous to attribute an object, found on the higher level *a priori* to the later period or *vice versa*. A striking illustration is the cult vessel Nos. 37 and 61, which was found in two pieces, one on the floor and the other on the level — 47. The fixed point in the discussion on the classification of the finds are the contents of the niches, undisturbed by the water: the two oldest burials of the tomb. To these belong the finds Nos. 79—88 and 101—106. It seems safer therefore to treat the four burials on the floor with the rest of the finds, as one single group, and only characterize it as later than the previous group, in spite of its heterogeneous composition.

Chambers C and D can be considered as a unit, for the connection between them was made purposely. In both chambers the deposits and the skeletal remains rested on the floor and were covered by a considerable amount of debris from roof and walls. In Chamber D two burials have taken place, apparently more or less simultaneously, one on the floor and one, of a slightly earlier date, in the niche. To the latter belonged Finds Nos. 1—6, and the rest should be attributed to the two bodies on the floor. Chamber C contained a baby's skeleton with a few tomb-gifts — Nos. 34, 35, 36, 37, 38, 40 and 41 — all evidently later than the finds in the niche of Chamber D.

BURIALS

In Chamber A the skeletons found in the niches lay in lateral positions with bent knees and the face towards the centre of the chamber, except for Skeleton No. 4, which has been seated with its back towards the E. wall of the niche. In a similar seated position the skeletons 7, 8, 9 have also been placed, and probably 13, 14, and 15, too. No. 11 seems to have been in a lateral lying position, but the two bodies Nos. 10 and 12 were too badly damaged to allow even of a conjecture.

Three of the four skeletons in Chamber B have been seated round the walls of the chamber, the fourth had entirely turned to dust, and the two bodies in the niches were lying in lateral position with drawn up knees.

The skeletons in Chambers C—D, i. e. the bodies in and below the niche in Chamber D, which were well enough preserved to be studied, have been laid in lateral positions.

It can be seen from the above description, that of the 26 skeletons found in the tomb, all the bodies in the niches were lying on their sides facing the centre of the chamber, with the exception of Skeleton No. 4 in Chamber A, where space admitted of a seated position. In the large chambers, the seated position seems to have been the rule for the burials on the chamber floor; but in the small Chamber D the body on the floor was laid out.

FINDS (GROUPS: PLS. XXIII, 2, 3, XXIV—XXVII, 1; TYPES: L. OF PL. II)

C h a m b e r A

1. Red Polished disc-shaped spindle-whirl. Radiating lines from centre to periphery. Paint obliterated. Diam. 5.5. Floor.
2. Fragments of a bronze dagger. Floor.
3. Bronze awl with square section, and a cylindrical bone handle. Length 9.6. Floor.
4. Bronze axe with narrowing sides, and convex edge. Length 9.5. Floor.
5. Two thin, flat wires of silver, used as bracelets. Diam. c. 6.0; c. 5.0. Floor.
6. Bronze axe as No. 4. Length 11.5. Floor.
7. Leaf-shaped bronze knife, with straight sides, rounded end, two edges, midrib, and flat tang with three rivet-holes. Length 16.5. Floor.
8. Broad bronze scraper with convex sides, rounded end, two edges, and a flat, narrow tang with one rivet-hole. Length 14.7. Floor.
9. Bronze tweezer with rounded top. Length 13.2. Floor.
10. Bronze chisel with square section and slightly convex edge; horn handle. Length 18.0. Floor.
11. Bronze sword with straight sides, pointed end, two edges, high midrib, two cuttings at root of tang, and a hooked, solid tang. Length 66.2. Floor.
12. Bronze sword of the same shape as No. 11. Length 53.5. Floor.
13. Bronze sword as No. 11. Length 55.6. Floor.
14. Narrow bronze sword as No. 11. Length 53.3. Floor.
15. Bronze tweezer as No. 9. Length 9.7. Floor.
16. Bronze scraper as No. 8. Length 13.3. Floor.
17. Bronze knife as No. 7. Top of tang missing. Length 21.6. Floor.
18. Fragments of a bronze pin. Floor.
19. Bronze scraper with concave sides, broad, rounded end, two edges, low midrib, and flat, narrow tang. Top of tang missing. Length 12.5. Floor.
20. Leaf-shaped bronze knife, with slightly concave sides, pointed end, two edges, low midrib, and a flat, rounded tang with three rivet-holes. Top of tang missing. Length 23.3. Floor.
21. Fragments of a Red Polished III globular jug with round base, narrowing, convex neck, wide rim, and handle from neck to shoulder. Floor.
22. White Painted II pear-shaped jug with round base, cylindrical neck, flat rim, handle from neck to shoulder; a tubular spout opposite the handle, and a knob above spout. Straight and wavy lines around neck, spout and handle, red base, and broad vertical bands of network and hatched lozenges from neck to belly. Height 23.5. Floor.
23. Black Polished plain hemispherical bowl with a string-hole projection at rim. Diam. 10.5. Floor.
24. Red Polished III pear-shaped amphora with round base, cylindrical neck, and small, flat rim. Handles missing. Hatched zigzag bands around neck and shoulder. Height 13.5. Floor.
25. Red Polished III jug as No. 22. Two wavy, vertical lines from rim to belly. Height 18.5. Floor.
26. Red Polished II pear-shaped jug with narrow neck, funnel-rim, handle from rim to shoulder and a hooked string-hole projection opposite the handle. Vertical bands of horizontal elements on neck; hatched bands on shoulder; parallel horizontal lines above base; body covered with a vertically arranged design of hatched zigzag bands, straight bands and triangles. Piece of rim missing. Height 21.2. Floor.
27. Red Polished II hemispherical bowl with a string-hole projection at rim. Diam. 16.5. Floor.
28. Fragments of a Red Polished III bowl mainly as No. 27. Floor.
29. Trapezoid whetstone. Length 12.0. Floor.
30. Plank-shaped whetstone with a hole. Length 13.6. Floor.
31. Red Polished III shallow bowl with round base and a string-hole projection immediately below rim. Even red. Not complete. Diam. 20.3. Floor.
32. Red Polished II bowl as No. 27. Diam. 13.2. Floor.
33. Bronze tweezer with rounded top. Length 12.7. Floor.
34. Red Polished III amphora as No. 24, but with widening neck, and two small handles from neck to shoulder. A hatched band around shoulder. Surface partly worn. Height 13.0. Floor.
35. Bronze needle with pointed end and flat head, pierced by an eyelet. Length 9.2. Floor.
36. Bronze pin with pointed end and flat head. Length 11.0. Floor.
37. Thick bronze pin with pointed end, button-head, and an eyelet through the middle. Length 30.7. Floor.
38. Bronze pin as No. 37. Length 30.3. Floor.
39. Fragments of a bronze pin with pointed end and thickening head. Floor.
40. Red Polished plank-shaped rectangular idol. A projection marks the nose, two dots the eyes; hatched, dotted, horizontal lines the eyebrows, and two projections on the sides of the head the ears. They are pierced by two holes each, for fixing earrings. From the nose towards the neck run two vertical lines, ending in three dots. Around the top of the head a hatched band represents the flat cap, and squares of short, horizontal lines on both sides of the neck probably suggest the hair. A band with hatchings and dots on the shoulder marks some embroidered details of the dress. Below these band hang concentric semicircles with impressed dots, representing necklaces. From the shoulder towards the waist are incised vertical lines, ending in three dots probably meant as a representation of arms or sleeves. A broad band of crossed zigzag lines around the waist marks the girdle. On the back of the head falls the hair over the shoulders. It is rendered by parallel oblique lines, connected with oblique hatched bands. The bands seem to represent some sort of hair-rings, probably bronze spirals (cf. below No. 70). The girdle is also rendered at the back. On the

- shoulders is a rough chess-board pattern, composed of short, horizontal lines which might suggest some ornaments on the gown. Total length 22.3. Floor.
41. Black Polished globular jug with round base, cylindrical neck, flat rim, and an upright horizontal handle on rim. Oblique lines on handle; short, horizontal and oblique lines around neck; body covered with framed and plain bands of oblique lines and concentric circles. Height 10.1. Floor.
 42. Red Polished III deep cooking-pot with round base, straight rim; one large and one small handle from rim to body. Height 14.7. Floor.
 43. Black Polished bowl as No. 23. Horizontal lines, crossed by zigzags around rim, and irregular, parallel zigzag lines around body. Diam. 9.0. Inside No. 44.
 44. Red Polished II bowl as No. 27. Diam. 15.0. Floor.
 45. Red Polished III cooking-pot as No. 42, but with one large handle, and a knob on the other side of the rim. Diam. 7.6. Floor.
 46. Red Polished II jug as No. 26. Horizontal, short lines, forming a chess-board pattern around neck; body covered with concentric circles; parallel, oblique lines, horizontal lines, and chevrons. Shoulder and handle missing. Height 13.6. Floor.
 47. White Painted II jug as No. 22, but without spout; mouth covered by a strainer. Straight and wavy lines around neck; a horizontal network frieze around belly; red base and broad vertical network bands from neck to belly with horizontal network bands, wavy lines and oblong chess-board patterns in the interstices. Height 24.0. Floor.
 48. Red Polished III depressed, spherical jug with round base, widening neck, splaying rim, and handle from neck to shoulder. Relief string-ornaments around neck, shoulder and belly. Height 27.6. Floor.
 49. Red Polished biconical spindle-whirl with flat ends and incised zigzag lines on the sides. Diam. 4.6. Floor.
 50. Red Polished conical spindle-whirl with bulging sides, and incised chevrons on the sides. Diam. 3.9. Floor.
 51. Red Polished spindle-whirl with groups of incised chevrons and oblique, parallel lines. Diam. 3.2. Floor.
 52. Red Polished conical spindle-whirl with tapering ends, and incised zigzag lines on the sides. Half missing. Diam. 2.7. Floor.
 53. Bronze pin with flat button-head, and a hole through the middle of the pin. Point missing. Length 21.0. Floor.
 54. Bronze pin with pointed end, thickening head, and a bronze wire, wound around the middle of the pin. Length 11.9. Floor.
 55. Bronze needle with pointed end. Length 7.2. Floor.
 56. Red Polished III large, globular jug with somewhat cylindrical neck; small, flat rim, and handle from neck to shoulder. Height 52.3. Floor.
 57. Black Polished conical spindle-whirl with tapering base. The body is covered with concentric lozenges, divided by three vertical lines and herring-bone patterns; a horizontal frieze of parallel lines, and a chain of hatched lozenges. Radiating lines and dots at base. Surface badly worn. Diam. 5.4. Floor.
 58. Bronze needle with pointed end and flattened head pierced by an eyelet. Length 8.9.
Fragment of a similar bronze needle. Length 4.7. Floor.
 59. Bronze dagger with pointed end, straight sides, rounded top, two edges, high midrib, and hooked, solid tang. End and tang bent. Length 34.0. Floor.
 60. Leaf-shaped bronze knife as No. 20. Length 14.5. Floor.
 61. Black Polished, squat, pear-shaped bottle with round base, narrow cylindrical neck, plain rim, and a string-hole projection at rim. Framed bands of parallel zigzag lines around neck and body. Height 7.9. Floor.
 62. Bronze tweezer of the same shape as No. 19. Length 13.5. Floor.
 63. Bronze scraper with widening arms and rounded top. Length 11.2. Floor.
 64. Bronze knife as No. 20. Length 16.3. Floor.
 65. Bronze sword of the same shape as No. 11. Length 51.2. Floor.
 66. Bronze sword with straight sides, pointed end, two edges, high midrib, heart-shaped top and a hooked, solid tang. Length 57.6. Floor.
 67. Bronze knife as No. 7, but with slightly convex sides. Length 16.2. Floor.
 68. Bronze pin with pointed end and thick knob-head. Length 25.8.
Bronze pin with thickening head and pointed end. Length 25.4.
Bronze pin with pointed end, thickening head and a bronze wire, wound around the middle of the pin. Length 11.3. Floor.
 69. Bronze needle with pointed end, and flattened head. Length 9.5. Floor.
 70. Flat bronze wire wound in tight spirals, probably used as hair ornaments (cf. above No. 40). Floor.
 71. White Painted II jug as No. 22, but without spout and knob. Horizontal bands of network and oblong chess-board patterns around neck and body; red base. Height 23.0. Floor.
 72. Bronze pin with pointed end, flat button-head, and an eyelet through the middle of the pin. Point missing. Length 39.8.
Bronze pin as the above described. Slightly bent. Length c. 36.0.
Bronze pin with pointed end and thickening head. Length 23.7.
Bronze pin with pointed end and small knob-head. Length 16.7.
Bronze pin with an eyelet through the middle of the pin. Much corroded, point missing. Length 14.7. Floor.
 73. Two bronze pins with pointed ends and large flat button-heads. Length 39.5; 27.0. Floor.
 74. Bronze sword of the same shape as No. 11. Length 64.1. Floor.
 75. Bronze tweezer as No. 9. Length 13.2. Floor.
 76. Bronze scraper as No. 19. Length 15.7. Floor.

77. Bronze knife as No. 20. Top of tang missing. Length 25.9. Floor.
78. Two bronze pins with pointed ends and knob-heads. Length 25.9. 24.6. Floor.
79. Bronze awl with square section and solid, narrow tang. Length 8.7. Floor.
80. Bronze awl with square section, and a bone handle. Length 9.9. Floor.
81. Leaf-shaped bronze knife with pointed end, concave sides, tapering top, two edges, low midrib, and two rivet-holes through the top. Length 7.5. Floor.
82. Trapezoid whetstone. Length 11.4. Floor.
83. Whetstone with narrowing sides, and two holes through top. Length 6.9. Floor.
84. Red Polished II bowl as No. 27. A frieze of lozenges below rim, and a frieze of parallel zigzag lines on body. Surface worn. Diam. 9.2. Floor.
85. Red Polished II jug as No. 26, but without projection. Horizontal lines around neck, shoulder and base, and a frieze of hatched lozenges around body. Height 16.0. Floor.
86. Red Polished II globular amphora with round base, slightly convex neck, splaying rim, and two knobbed handles from neck to shoulder. Wavy, pinched relief-lines on neck and shoulder. Height 58.5. Floor.
87. Red Polished III globular jug with round base, backwards-curved neck, beaked mouth, and handle from rim to shoulder. Vertical zigzag lines on neck; horizontal similar lines and knobs on shoulder. Mouth missing. Paint worn. Height 25.0. Floor.
88. Red Polished II jug as No. 85. Bands of horizontal lines around neck, shoulder, and base, and two horizontal, framed friezes of parallel zigzag lines on the body. Surface worn. Height 12.2. Floor.
89. Triangular bronze dagger, with pointed end, two edges, high midrib, heart-shaped top, and a hooked, solid tang. Length 32.8. Floor.
90. Leaf-shaped bronze knife with concave sides, pointed end, two edges, low midrib, broad top, and a flat tang; three rivet-holes through top and tang. Length 19.3. Floor.
91. Fragment of a circular bronze ring of flat wire. Floor.
92. Black Polished bowl as No. 23. Hatched incised bands and oblique lines in an irregular pattern. Diam. 9.2. Floor.
93. Rectangular flat. Red Polished idol, with a flat upwards widening head. A projection marks the nose, two dots the eyes, and two horizontal lines the mouth. From the nose hangs a vertical line, ending in a dot. Around the face are groups of short, horizontal lines, suggesting the hair, and an incised ridge around the top of the head represents the flat cap. Four parallel lines above the shoulder mark the beginning of the gown, and a band with dots and hatchings, hanging round the shoulders represents necklaces and embroidery. From the shoulders towards the waist run two oblique lines, ending in three impressed dots which might represent sleeves or arms. A broad band of parallel lines around the waist suggests a girdle. Two small projecting knobs below the shoulders mark the breasts. On the back the hair falls in a plait over the shoulders, rendered as a vertical zigzag band. The girdle is marked also on the back by horizontal lines, and on the back of the shoulder are small groups of short, horizontal lines, suggesting some decorations on the gown. Surface partly worn on the front side. Total length 24.9. Floor.
94. Red Polished II jug as No. 85, but with shorter neck. Decoration as No. 88, but with hatched triangles in the friezes. Height 11.2. Floor.
95. Bobbin-shaped whetstone with a hole at top. Length 10.5. Floor.
96. Bronze pin with pointed end and small knob-head. Length 15.4. Floor.
97. Bronze pin as No. 96. Length 25.6. Floor.
98. Bronze pin with pointed end, and thickening head. Point missing. Length 27.2. Floor.
99. Bronze pin as No. 98. Length 28.4. Floor.
100. Triangular whetstone, pierced by a hole in one corner. Length 10.3. Floor.
101. Bronze dagger as No. 59. The dagger is bent. Length 28.0. Floor.
102. Bronze scraper as No. 8, but with straight sides. Length 15.4. Floor.
103. Bronze scraper as No. 102. Length 15.0. Floor.
104. Leaf-shaped bronze knife, with pointed end, concave sides, two edges, low midrib, and a flat, narrow tang with one rivet-hole. Length 14.0. Floor.
105. Bronze tweezer with loop-shaped top and widening arms. Length 15.9. Floor.
106. Bronze tweezer as No. 105. Length 15.3. Floor.
107. Bronze pin with flat head and pointed end. Length 9.8. Floor.
108. Bronze needle with flattened head, pierced by an eyelet. Head missing. Length 6.8. Floor.
109. Black Polished plain bottle with round base; tapering, convex neck; small, stilted rim; and a small handle from neck to shoulder. Several parts missing. Floor.
110. Triangular bronze axe with convex edge. Length 8.8. Floor.
111. Red Polished III jug as No. 56. Height 54.5. Floor.
112. Red Polished III globular jug with round base; cylindrical, cut-away neck; oblique rim, and an incised handle from neck to shoulder. A large string-hole opposite the handle, and button-ornaments on neck. Height 59.5. Floor.
113. White Painted II globular askos with round base, tubular spout, and a horizontal upright handle placed transversely on body. A complicated pattern of hatched lozenges, network bands, concentric circles, wavy lines and ladder-patterns covering the body. Red base. Much damaged. Height 20.7. Floor.
114. White Painted II pear-shaped amphora with flat base, convex neck, flat rim and two small, knobbed handles from neck to shoulder. Oblong chess-board patterns and network bands around neck; red base; transverse lines on the handles, and vertical bands of network, chevrons, and oblong chess-board patterns from neck to belly. Height 25.0. Floor.

115. Three bronze needles with pointed ends and flattened heads pierced by eyelets. Length 9.1; 8.8; 8.8. Floor. Bronze pin with pointed end, knob-head and an eyelet through the upper part of the pin. Length 13.8. Floor. Plain bronze pin with pointed end. Length 14.9. Floor. Bronze pin with pointed end, and flattened head. Length 13.0. Floor.
116. Fragments of a necklace consisting of spherical paste beads. Floor.
117. Finger-ring of silver, made of a flat wire, wound in a spiral. Diam. 1.9. Found in the sieves.
118. A chip of flint. Length 1.7. Found in the sieves.

C h a m b e r B

1. Red Polished III globular jug with round base, tall, slightly convex neck, stilted rim, and handle from neck to shoulder. Incised lines and impressed dots on handle. Height 52.3. — 51.
2. Red Polished III jug as No. 1. Vertical zigzag lines on neck and handle. Height 26.8. Floor.
3. Spherical paste bead and a bronze fragment. — 50.
4. Black Polished conical spindle-whirl with incised zigzag lines, chevrons, concentric semicircles, and parallel oblique lines on the sides. Diam. 4.0. Floor.
5. The half of a Black Polished conical spindle-whirl with hatchings on the sides. See No. 46. Diam. 3.4. Floor.
6. Red Polished conical spindle-whirl with incised lines and hatchings on the sides. Diam. 4.5. Floor.
7. Red Polished spindle-whirl as No. 6. Diam. 5.1. Floor.
- 8—10. Three spherical paste beads. Floor.
11. Bronze pin with pointed end and button-head. Length 35.0.
Bronze pin with pointed end and button-head. Slightly bent. Length 34.5.
Bronze pin with pointed end, knob-head, and a flat bronze wire, wound around the middle of the pin. Length 25.5.
Bronze pin with pointed end, knob-head, and a flat bronze wire, wound around the middle of the pin. Slightly bent. Length 26.1.
Bronze pin with pointed end, knob-head, and traces of a flat bronze wire, wound around the middle of the pin. Length 14.5. Floor.
12. Bronze pin with pointed end, thickening head and a flat bronze wire, wound around the middle of the pin. Badly corroded. Length c. 21.0. — 44.
13. Plain White globular amphora with flat base, concave neck, stilted rim, and two vertical handles with string-hole projections on shoulder. Height 39.0. — 37.
14. Red Polished III cooking-pot with oval body, wide, slightly concave neck, and two handles from rim to shoulder. Height 23.5. — 46.
15. Red Polished III shallow bowl with round base and a string-hole handle at rim. Diam. 21.7. — 41.
16. Red Polished III globular amphora with flattened base, cylindrical neck, flat rim, and two small handles from neck to shoulder. Roughly parallel zigzag lines, and hatched lozenges around neck; vertical bands of hatched lozenges, hatchings, chevrons, concentric circles, and lattice-bands from shoulder to belly, and parallel zigzags above the base. Half the vase blackened in the kiln. Height 19.0. — 48.
17. Red Polished III amphoriskos as No. 16, but with small stilted rim. Small, concentric circles, and short horizontal lines in vertical bands on neck; friezes of ladder-patterns below neck and above base, and a band of parallel zigzag lines around body with small, concentric circles in the angular interstices. Height 9.0. — 49.
18. Red Polished II hemispherical bowl with a string-hole projection at rim. A zigzag frieze around rim, and concentric circles on body. Black inside. Rim chipped. Surface worn. Diam. 7.6. — 43.
19. Red Polished II hemispherical bowl with a string-hole projection at rim. Diam. 9.3. — 43.
20. Flat Red Polished idol, with rectangular plank-shaped body. The nose is marked by a small projection, and the nostrils by two small dots; two larger dots on both sides of the nose represent the eyes, and vertical lines the eyebrows and the mouth. Around top of head are two hatched bands, suggesting a flat head-dress. Around the upper part of the neck, are two other bands with hatched lozenges and triangles, and on the shoulder concentric, semicircular, hatched bands. The latter represent necklaces. From the shoulder, towards the waist run two incised bands, ending in impressed dots, which might be a primitive representation of sleeves or arms. Around the waist runs a broad band of lozenges and horizontal lines, which are meant to represent a girdle. On the back of the head is a broad band of vertical zigzag lines, suggesting the wavy hair, falling down towards the shoulders. The girdle around the waist is represented also on the back, and the shoulders are adorned with short zigzag bands suggesting the embroidery of the gown. Left side of the body chipped. Surface worn on the front side. Total length 23.7. — 40.
21. Red Polished flat idol, of mainly the same type and decoration as No. 20. The only differences between the two idols is the decoration of the bands around neck and waist. Here they consist of zigzag lines, short vertical lines, and parallel oblique lines. Surface worn at the face and the neck. Total length 20.9. — 42.
22. Red Polished III bowl, mainly as No. 19. Mat polish. Fragmentary. Diam. 14.5. — 37.
23. White Painted II shallow bowl with round base and a horizontal, high handle at rim. Hatched triangles around rim; bands of parallel lines and crossed oblique lines on base; concentric wavy lines inside, and transverse lines on handle. Diam. 13.2. — 41.
24. Red Polished III bowl, mainly as No. 19. Smashed. Mat polish. Not complete. Diam. 13.0. — 36.
25. Bronze pin as No. 12. Length 11.5. — 37.
26. Red Polished III pear-shaped jug with round base, narrow, cylindrical neck; wide funnel-rim, an angular handle from neck to shoulder, and a string-hole projection opposite the handle. A chess-board pattern of horizontal,

- short lines around neck, and three framed friezes around shoulder and body, one with parallel, oblique lines, one with parallel zigzag lines, and one with hatched lozenges. Transverse lines on handle. Rim missing. Height 14.0. — 15.
27. Red Polished III bowl as No. 19. Mat polish. Diam. 9.8. — 38.
28. Red Polished III askos in the shape of a bird's body. The vase has rounded base, cylindrical neck, and a basket-handle from neck to back. Rim and handle missing. Height 14.7. — 40.
29. Red Polished II oval amphora with flat base, concave neck, splaying rim, and two handles from neck to shoulder. One handle missing. Height 18.5. — 43.
30. Red Polished III bowl mainly as No. 19. Not complete. Mat polish. Diam. 13.0. — 44.
31. Bronze needle with pointed end and flattened head, pierced by an eyelet. Length 10.4. — 41.
- 32 — 42 ÷ 44. Necklace of 71 spherical, plain paste beads. The beads are of five different sizes and the composition of the necklace could be approximately reconstructed. The beads have been rhythmically arranged in four series beginning and ending with the smallest beads, and culminating in a large bead. Three fragments of tight, bronze spirals of flat wire, seem to have served as clasps. — 60 and floor.
33. Bronze leaf probably belonging to the necklace No. 32 — 42 — 44. Length 3.0. Floor.
34. Red Polished III bowl, mainly as No. 19. Mat polish. Diam. 15.8. — 58.
35. Red Polished III oval jug with round base, cylindrical neck, splaying rim, handle from neck to shoulder, a projection on neck, and a spout opposite the handle; a strainer covers the mouth. Rim chipped. Height 23.0. — 60.
36. Red Polished III shallow bowl with broken base. Has apparently been fixed on the shoulder of a large jug. Diam. 8.8. — 45.
- 37 — 61. Red Polished III cult vessel. The vase is composed of four hemispherical bowls connected into a square. Above the bowls is a high rectangular plank-shaped handle pierced by three oblong holes and surmounted by three miniature vases. Chess-board pattern on bowls, and bands of horizontal lines and parallel, oblique lines on handle. Height 22.5. Floor and — 47.
38. Fragments of a Red Polished III coupled vase. — 51.
39. Fragments of a Red Polished III jug. — 55.
40. Red Polished flat, rectangular idol. A projection marks the nose and two impressed dots, surrounded by smaller dots represent eyes and lids; two vertical lines above the eyes mark the eye-brows, and a circular dot below the nose represents the mouth. From the mouth run two, vertical incised lines ending in a dot. Parallel lines around top of head suggest a flat head-dress, and plain and hatched triangles along the sides of the head are meant to suggest plaits of hair, falling towards the shoulders. Around the lower part of the neck is an incised band of parallel oblique lines which marks the beginning of the gown. The left arm of the idol holds a cradle with a small child. Above the head of the child is a bow. The cradle is adorned with hatchings and parallel lines. Around the neck and the upper part of the breast are concentric semicircles with impressed dots representing a rhythmically arranged necklace (cf. the necklace No. 32 — 42 — 44 and the necklace No. 78) The dots seem to represent the larger beads in the rhythmical series. From the shoulder, obliquely towards the waist, run two parallel incised lines adorned with impressed dots, which seem to suggest sleeves or arms (cf. the idols Nos. 20 and 21). Along the sides of the body are incised, short, horizontal lines, arranged in small groups, and immediately above the base is a horizontal, hatched band. These details represent the borders and embroideries of the gown. At the back of the head, the hair is marked by two parallel zigzag bands, and around the waist are two horizontal, hatched bands. The shoulders are adorned with a chess-board pattern composed of short horizontal lines on the back. Paint worn on the front side. Total length 29.5. — 19.
41. Red Polished III hemispherical bowl with two string-hole projections at rim. Parallel, horizontal lines around rim; parallel, oblique lines; framed, hatched, vertical bands, and chevrons on the body. Not complete. Diam. 14.6. — 51.
42. See No. 32.
43. Fragment of a bronze leaf as No. 33. Length 3.0. Floor.
44. See No. 32.
45. Large bronze tweezer with loop-shaped top. Length 14.3. Floor.
46. The half of a Black Polished conical spindle-whirl, with incised hatchings on the sides; belongs to No. 5. Diam. 3.4. Floor.
47. Red Polished II bowl as No. 19. Not complete. Diam. 16.8. — 59.
48. Black Polished conical spindle-whirl with incised hatchings on the sides. Diam. 4.3. — 67.
49. Black Polished pear-shaped bottle with round base; narrow, tapering neck, plain rim, and a string-hole below rim. Encircling bands of parallel lines around neck; a hatched band around shoulder, and hatched bands, alternating with fringed, straight lines from shoulder to base. Height 8.2. — 66.
50. Red Polished conical spindle-whirl with incised, hatched lozenges and bands, and crossed zigzag lines on the sides. Diam. 5.5. — 51.
51. Red Polished II pear-shaped jug with round base; short, cylindrical neck, wide funnel-rim, and handle from rim to shoulder. A large projection opposite the handle. Bands of horizontal lines around neck; concentric semicircles, chevrons, dotted lines, and designs resembling a brush or a comb on body. Height 19.0. — 52.
52. Red Polished II bowl as No. 19. Diam. 8.8. — 65.
53. Black Polished pear-shaped jug with flat base; narrow, tapering neck, funnel-rim, handle from rim to shoulder, and a hooked projection on the shoulder opposite the

- handle. Hatched bands and straight lines around neck; vertical bands of hatched zigzag lines, alternating with chevrons and hatched triangles, on body; concentric circles around belly; hatched zigzag bands on handle, and chevrons and hatched bands on rim. Height 11.6. — 66.
54. Hemispherical knob with impressed dots, belonging to a Red Polished III jug. Diam. 5.9. Floor.
55. Fragments of a Red Polished II bowl as No. 19. Diam. 8.2. Floor.
56. Red Polished III oval cooking-pot with round base, widening neck, and two handles from rim to shoulder. Height 22.8. — 60.
57. Red Polished biconical spindle-whirl with one flat end, and incised bands with parallel, oblique lines, and hatchings on the sides. Diam. 4.0. — 61.
58. Red Polished III globular jug with round base; tapering, backwards-curved neck, beaked mouth, handle from base of rim to shoulder, a string-hole projection on the neck, and large knobs below and opposite the handle. Incised zigzag bands on neck and handle, and hatchings below and opposite the handles. Height 31.2. — 63.
59. Red Polished III bowl, mainly as No. 19. Fragmentary. — 61.
60. Red Polished III bowl, mainly as No. 19. Diam. 14.0. — 55.
61. Fragment of a cult vessel. See No. 37. Floor.
62. Bronze knife with convex sides; broad, rounded end, angular top, two edges, and flat, tapering tang with one rivet-hole. Length 13.3. — 55.
63. Bronze needle with flattened head, pierced by an eyelet. Not complete. Length 7.8. — 55.
64. Bronze pin as No. 12. Length 15.0. — 63.
65. Bronze pin as No. 12. Length 11.3. Floor.
66. Fragment of a miniature idol of the flat rectangular type. The nose is marked by a projection, the eyes by two circular dots, and the nostrils by two, short, vertical lines. Two horizontal lines around the top of the head represent the flat cap; concentric segments around the neck suggest necklaces, and a band below the projecting shoulders marks a girdle. On the back of the head the hair is indicated by hatchings, and a horizontal band between the shoulders is, evidently, to be interpreted as embroideries on the gown. Total length 4.8. Floor.
67. Red Polished II pear-shaped jug with round base, tapering neck; funnel-rim, and handle from rim to shoulder. Bands of horizontal lines around and below neck, and vertical bands of oblique and horizontal lines from shoulder to base. Body partly missing. Height 17.0. — 63.
68. Fragments of a Red Polished II jug mainly as No. 67. — 63.
69. Red Polished III oval jug with round base, cylindrical neck, stilted rim, and handle from neck to shoulder. Impressed cavities and incised lines on handle. Height 30.0. — 59.
70. Red Polished III globular jug, with round base; cylindrical neck, stilted rim, and handle from neck to shoulder. Rim chipped; paint worn. Height 22.3. — 59.
71. Bronze pin with pointed end, and thickening head. Slightly bent. Length 33.0. Floor.
72. Bronze pin with pointed end and flat button-head. Length 29.6. Floor.
73. Bronze needle with flattened head, pierced by an eyelet. Length 8.7. Floor.
74. Bronze needle as No. 73. Length 14.3. Floor.
75. Bronze knife with slightly concave sides, rounded end, two edges, low midrib, rounded top, and flat tang with one rivet-hole. Length 19.0. Floor.
76. Large, conical spindle-whirl with rounded top; paint obliterated. Diam. 5.9. Floor.
77. Red Polished II bowl as No. 19. Diam. 9.5. Floor.
78. Necklace of 64 spherical paste beads with a great amount of red, small, cylindrical beads in their interstices. The composition of the necklace is very complicated. The white beads, separated by 3—4 small beads, are arranged in rhythmical series (cf. necklace No. 32 — 42 — 44). The front part of the necklace consists of three rows of large and small beads, and one row entirely consisting of small beads. When hanging around the neck, the front piece forms a fan-shaped decoration. Floor.
79. White Painted II pear-shaped jug with round base, cylindrical neck, beaked mouth, and handle from rim to shoulder. Encircling, straight and wavy lines around neck; broad lattice-bands, alternating with wavy lines from neck to base, and concentric circles on base. Handle missing. Height 24.3. Floor.
80. Black slip I oval jug with round base, cylindrical neck, splaying rim, handle from neck to shoulder, and a string-hole projection opposite the handle. Incised lines on handle. Surface mottled. Height 30.3. Floor.
81. Red Polished III jug as No. 80. Height 31.7. Floor.
82. White Painted II globular jug with round base, concave neck, splaying rim, and handle from neck to shoulder. Encircling lines around rim and neck, broad lattice-bands, alternating with wavy lines from neck to base, and concentric circles on base. Height 20.5. Floor.
83. Red Polished III globular jug with round base, cylindrical neck, beaked mouth, handle from rim to shoulder, and a projection opposite the handle. Rim chipped. Height 21.6. Floor.
84. Bronze tweezer with a solid knob at the top. Length 11.9. Floor.
85. Leaf-shaped bronze knife with slightly concave sides, pointed end, two edges, midrib, and a flat, tapering tang with two rivet-holes. Length 22.9. Floor.
86. Bronze awl with square section, and solid, tapering tang. Length 20.9. Floor.
87. Bronze scraper with concave sides, straight end, two edges, low midrib, and a flat tang with one rivet-hole. Length 13.8. Floor.
88. Bronze scraper as No. 87, but with rounded end. Length 13.5. Floor.
89. Bronze dagger with straight sides, pointed end, two edges, high midrib, two cuttings near the tang, and hooked, solid tang. Length 40.4. Floor.
90. Red Polished II bowl as No. 19. Diam. 12.3. Floor.

91. Leaf-shaped bronze knife with pointed end, concave sides, two edges, low midrib, and tapering top with three rivet-holes. Length 15.7. Floor.
92. Red Polished conical spindle-whirl. Diam. 4.2. Floor.
93. Bronze dagger with slightly convex sides, pointed end, two edges, high midrib, two cuttings near the tang, and a hooked, solid tang. Length 23.8. Floor.
94. Bronze dagger as No. 89. Length 32.1. Floor.
95. Bronze axe with widening sides, and convex edge. Length 12.6. Floor.
96. Oblong whetstone with a hole through the top. Length 7.1. Floor.
97. Bronze scraper as No. 87; but with broad tang. Length 13.8. Floor.
98. Bronze scraper as No. 88. Length 9.8. Floor.
99. Bronze tweezer with rounded top. Length 8.1. Floor.
100. Two bronze pins with pointed ends and small knob-heads. Length 12.5; 9.6. Floor.
101. White Painted II pear-shaped jug with round base; backwards-curved, cylindrical neck, beaked mouth, handle from rim to shoulder, and two string-hole projections on rim. Straight and wavy lines around rim and neck, broad lattice-bands, alternating with zigzag bands from neck to base; red polished base; transverse lines on handle, and a wavy line inside rim. Height 31.0. Floor.
102. Circular silver ring of flat wire with overlapping ends. Diam. 1.9. Floor.
103. Bronze tweezer as No. 99. Length 7.3. Floor.
104. Bronze dagger as No. 89. Edge chipped. The dagger is slightly bent. Length 34.1. Floor.
105. Bronze scraper with straight sides, rounded top, two edges, and flat, tapering tang with three rivet-holes. Length 11.5. Floor.
106. Bronze axe as No. 95. Broken. Length 10.6. Floor.

C h a m b e r C—D

1. Red Polished II hemispherical bowl with a string-hole projection at rim. Piece of rim missing. Black inside and rim. Diam. 11.2. Floor.
2. Red Polished II large globular jug with round base; tapering neck, and handle from neck to shoulder. Rim missing. Height 51.2. Floor.
3. Red Polished II globular jug with round base; straight, tapering neck, splaying rim, and handle from neck to shoulder. Rim chipped. Height 32.4. Floor.
4. Leaf-shaped bronze scraper with rounded end, two edges, and tapering, straight tang. Length 11.9. Floor.
5. Almost triangular bronze dagger with straight, slightly convex sides, broad heart-shaped top, pointed end, midrib, two edges, and hooked, solid tang with traces of windings. Length 30.7. Floor.
6. Bronze tweezer with widening arms and pinched top forming an oblong loop. Length 14.9. Floor.
7. Fragments of a White Painted II amphora. Floor.
8. Red Polished II incised, pear-shaped jug with round base; tall, tapering neck, funnel-rim, and handle from rim to shoulder. Bands of horizontal lines around neck and shoulder, and an oblong chess-board pattern of horizontal, short lines with oblique, parallel lines in the interstices, covering the body. Rim missing. Paint and surface worn. Height 11.0. Floor.
- 9 + 10. Red Polished III globular jug with round base, cylindrical neck, and handle from neck to shoulder. Height 49.5. Floor.
11. Red Polished II large globular jug with tall, tapering neck, wide rim, and handle from neck to shoulder. Horizontal and vertical relief decoration on neck. Body broken, rim badly chipped. Floor.
12. Red Polished II bowl as No. 1. Piece of rim missing. Black inside and rim. Diam. 13.2. Floor.
13. Red Polished III sack-shaped cooking-pot with round base; tapering rim, and two high handles from rim to shoulder. Traces of a punctured relief-ornament between the handles. Height 12.5. Floor.
14. Red Polished III globular jug with round base, cylindrical neck, wide funnel-rim, a knobbed handle from neck to shoulder, and a large string-hole opposite the handle. Height 31.0. Floor.
15. Red Polished III globular amphora with round base; cylindrical, wide neck; somewhat splaying rim, and two handles from neck to shoulder. One handle and pieces of rim missing. Height 29.5. Floor.
16. Red Polished II bowl as No. 1; mat red. Black inside and rim. Diam. 14.5. Floor.
17. Fragments of a Red Polished II incised jug. Floor.
18. Red Polished II bowl as No. 1. Piece of rim missing. Black rim and inside. Diam. 16.8. Floor.
19. Red Polished III jug as No. 9 + 10. Body much broken. Floor.
20. Red Polished III large, globular amphora with round base; cylindrical, convex neck, splaying rim, and two knobbed handles from neck to shoulder. Zigzag incisions and pinched relief-lines around neck and shoulder. Height 49.5. Floor.
21. Red Polished II globular amphora with round base; wide, short neck; splaying rim, and two small angular handles from neck to shoulder. Height 18.5. Floor.
22. Red Polished II jug as No. 8, but with parallel chevrons as front ornament, and vertical bands of short, horizontal lines from shoulder to belly. Body damaged. Height 14.6. Floor.
23. Red Polished II hemispherical bowl with a string-hole projection at the rim. Black rim and inside. A band of horizontal lines, crossed by a single zigzag line around rim, and two framed friezes of hatched lozenges around body. Diam. 11.2. Floor.
24. Red Polished II bowl as No. 1, but even red. String-hole projection missing. A band of oblique, short, parallel lines around rim; a frieze of hatched lozenges below rim, and another frieze of parallel zigzags above base. The two friezes are separated by a band of zigzag lines and dots. Diam. 10.8. Floor.
25. Red Polished III oblong sack-shaped bottle with rounded base, backwards-curved neck, beaked mouth, and a

- small handle from neck to shoulder. Horizontal lines around neck and shoulder, chess-board patterns on both sides of body, and horizontal bands of hatched lozenges opposite and below the handle. Height 13.9. Floor.
26. Red Polished II jug as No. 8. Bands of horizontal lines around neck and shoulder; a skeuomorphic design of concentric circles, connected by bands of parallel lines in horizontal and oblique direction. Surface and paint worn. Height 10.6. Floor.
 27. Red Polished biconical spindle-whirl. Diam. 4.15. Red Polished conical spindle-whirl with narrow base. Diam. 3.4. Floor.
 28. Bronze sword with straight sides, pointed end, two edges, broad heart-shaped top; solid, hooked tang with square section, ending in a button of rectangular shape. Length 41.1. Floor.
 29. Lower part of a large bronze sword with pointed end, midrib, two edges, and straight sides. Length 34.1. Floor.
 30. Bronze sword with straight sides, pointed end, two edges, midrib, rounded top with deep cuttings, and hooked, solid tang. Traces of windings at root of tang. Length 52.5. Floor.
 31. Bronze knife with concave sides, pointed end, low midrib, two edges, flat concave top, and two rivet-holes. Length 20.5. Floor.
 32. Fragments of a long, thick bronze pin with flat head. Floor.
 33. Fragments of a straight, thin bronze pin with pointed end. Floor.
 34. Red Polished III globular jug with round base, cylindrical neck, beaked mouth, handle from rim to shoulder, string-hole projection between neck and shoulder, and a tubular spout opposite the handle. Height 19.5. Floor.
 35. Red Polished III incised bowl, mainly as No. 23. A band of herringbone-pattern around rim, and framed, vertical lines, filled with short, horizontal and oblique lines, running from rim to base. Diam. 10.9. Inside No. 36.
 36. Red Polished II bowl as No. 1. Rim chipped. Black inside and rim. Diam. 12.5. Floor.
 37. Red Polished II jug as No. 8. Neck missing. Surface much worn. Height 15.0. Floor.
 38. Red Polished II bowl as No. 1. Diam. 10.2. Floor.
 39. Fragment of a spiral ring of bronze. Diam. 1.7. Floor.
 40. Red Polished III jug as No. 34, but without spout. Relief button-ornaments on neck and shoulder. Height 36.0. Floor.
 41. Red Polished II bowl as No. 1. Diam. 9.8. Floor.
 42. Rectangular bronze scraper with concave sides, rounded corners, flat end, and thin, tapering tang with one rivet at top. Length 10.6. Floor.
 43. Triangular bronze axe with straight sides, fan-shaped edge, and traces of a wooden handle at top. Length 8.75. Floor.
 44. Lump of iron. Floor.
 45. Spiral-ring of flat bronze wire. Diam. 1.2. Floor.
 46. Spiral-ring of flat bronze wire. Diam. 1.9. Floor.

An attempt to classify the pottery finds and distribute them among the different burial groups, is made in the following diagram.

	P o t t e r y						B r o n z e											Sil- ver	Iron	Fai- ence	Stone	Terra- cotta	Flint		
	R. P. II	R. P. III	Wh. P. II	Bl. Sl.	Pl. Wh.	Bl. P.	Pins	Needles	Knives	Daggers	Scrapers	Swords	Axes	Awls	Chisels	Twizzers	Rings	Rings	Lump	Beads & Neckl.	Whetstones	Spindle-whirls	Idols	Chip	
Chamber A 1st group	84. 85	56. 86	113			61	68. 68	69	67	89	76	66	110	79		75	70	117		116	82		93	118	
	88. 94	87. 111	114			92	68. 73	108	77	101	102	74	80			105	91				83				
		112				109	73. 78	115	81		103					106					95				
							78. 96	115	90													100			
							97. 98	115	104																
						99. 107.																			
						115. 115																			
						115																			
	-4	-5	-2			-3	-15	-5	-5	-2	-3	-2	-1	-2		-3	-2	-1		-1	-4		-1	-1	
2nd group	44	42	71			41	72. 72		7	2	8	11	4	3	10	9		5						140	
						43	72. 72					12	6												
						72																			
	-1	-1	-1			-2	-5		-1	-1	-1	-2	-2	-1	-1	-1		-1						-1	-1

	Pottery						Bronze											Sil- ver	Iron	Fa- ience	Stone	Terra- cotta	Flint			
	R. P. II	R. P. III	Wh. P. II	Bl. Sl.	Pl. Wh.	Bl. P.	Pins	Needles	Knives	Daggers	Scrapers	Swords	Axes	Awls	Chisels	Tweezers	Rings	Rings	Lump	Beads & Neckl.	Whetstones	Spindle-whirls	Idols	Chip		
3rd group	26, 27 32, 46	21, 24 25, 28 31, 34 45, 48	22 47			23	18, 36 37, 38 39, 53 54	35 55 58 58	17 20 60 64	59	16 19 62	13 14 65				15 33 6									29 30	49 50 51 52 57 5
Chamber B 1st group		81, 83 -2	79 82 101 -3	80 -1					85 104 -1	104 87 88 105 -1			106 86 -1		Leaves -2	84 103 -1		102 -1								
2nd group	18, 19 29, 47 51, 52 55, 67 68, 77 90	1, 2 14, 15 16, 17 22, 24 26, 27 28, 30 34, 35 36, 38 37+61 39, 41 54, 56 58, 59 60, 69 70	23	13	49 53	11, 11 11, 12 25, 64 65, 71 72, 100 100	31 63 73 74 97	62 75 91 94	89 93 94	98			95		33 43	45 99					3 8 9 10 32 42 44 78	96			4 20 5 21 46 40 6 66 7 48 50 57 76 92	
Chamber C—D 1st group	1, 2 3 -3								5 -1	4 -1					6 -1											
2nd group	8, 11 12, 16 17, 18 21, 22 23, 24 26, 36 37, 38 41	9+10 13, 14 15, 19 20, 25 34, 35 40	7			32, 33	31	42	28 29 30	43						39 45 46		44							27 27	
	-15	-10	-1			-2	-1	-1	-3	-1					-3		-1								-2	

CHRONOLOGY

Considering the picture of Chamber A, given by the diagram, it is easy to see the difference of time between the first and the third groups. In the latter, the Red Polished II Ware is represented by two vases of a rather late type Nos. 26 and 46 and two bowls. The presence of bowls Nos. 27 and 32 is not surprising, as it is a well known fact that simple shapes in the pottery stick more strongly to traditional types, than the complicated ones.

The White Painted II pots in the earlier groups of Chambers A and B are early represen-

tatives of their class, and are not sufficient to date their groups to the Middle Cypriote epoch. But their presence especially in such a rich tomb as 313, is easily explained.

The rest of the diagram speaks for itself and the dating of the tomb should be assigned as follows: — To the Middle of E. C. III belong the first group of Chamber A and the whole Chamber C—D; to the end of the same period belong the rest of the finds, and the latest burials seem to have taken place in Chamber B, the second, heterogeneous group of which contained transitional types, between E. C. III and M. C. I.

TOMB 314 (Fig. 44: 1—5)

	SIZE			
	Length	Width	Depth	Height
Dromos	3.78	2.34	1.90	—
Stomion A	0.45	0.70	—	0.40
Chamber A.....	2.05	3.73	—	0.82
Stomion B	1.05	0.95	—	0.78
Chamber B.....	2.90	5.45	—	1.35

SHAPE

The dromos is very large and resembles, to a certain extent, that of Tomb 311. One section of the apsidal end is angular because of the entrance to Chamber A, which was placed right in the corner. The walls taper downwards and the floor slopes gently towards the entrance of the main chamber.

The tomb contained two chambers, one — Chamber A — at the very N. end of the long E. side, and one opening from the short front side — Chamber B. The door of Chamber A was surrounded by a moulding of rectangular shape, sunk into the façade of the rock. The moulding seems to have been, principally, decorative, and the door stone was of the usual irregular type. A very narrow, steeply sloping stomion, which widens considerably towards the inside, leads down to the chamber. The plan of the tomb is oval with niches on the short side at about 0.20 m. above the level of the floor. Walls and roof formed a flat vault, and the floor was almost horizontal. The chamber was remarkably well preserved, thanks to its symmetrical shape and well balanced proportions.

Chamber B was in a good state of preservation too, and of roughly the same shape as Chamber A. The stomion, however, projects far into the chamber so as to render it slightly “kidney-shaped”. A niche was found on each short side, raised approx. 0.20 m. above the floor.

STRATIFICATION

The dromos contained a homogeneous filling of the usual kind. Only a thin layer on the floor was harder than the rest of the earth, and might have emanated from the original filling. The *chavara*, filling the upper part of the dromos, contained a good many potsherds

of the Red Polished II class, and had apparently been dug through at the repeated burials of the chambers.

In Chamber A all the finds and the skeletons were found directly on the floor and thanks to the good preservation of the chamber, they were not covered by debris or other extraneous matter. Three skeletons were found in the chamber, one in each niche and one on the floor below the N. niche. The niches were small, for which reason apparently, they contained only the remains of the dead bodies and practically no finds; the latter were all found on the chamber floor. For this reason an attempt to establish a relative chronology of the contents is idle, but to judge from the pottery, there seems to be no very great difference in time between the three burials.

In Chamber B the stratigraphical conditions were almost the same. The find stratum was bare, and only close to the back wall had some pieces of rock fallen from the roof. There were six burials in the chamber, two in the W. niche, one near the central part of the back wall opposite the entrance, another in a badly damaged state along the same wall, one in the E. niche, and one on the floor in front of the niche to the left of the entrance. They are numbered in the above order, from 1 to 6. No. 6 seems to be the last, and Nos. 1, 2 earlier than the rest, but to fix their relative order is very uncertain. As the chamber was crowded, it was also very difficult to distribute the finds between the bodies. The finds in the niches, presumably belonging to an earlier group, were Nos. 18—29, 58, 87 and 88, but it seems hardly possible to divide the rest into smaller groups according to their disposition. It is preferable to treat them as one, but due consideration must be paid to its slightly heterogeneous origin.

BURIALS

In the N. niche of Chamber A the skeletal remains were very scanty. The positions of the pelvis and of fragments of femora and tibiae are, however, clear enough to allow of the assumption that the dead body had been deposited lying on its back with the legs drawn up. The skeleton in the opposite niche has been buried in another manner: there the femora and the tibiae were found parallel and close together, and fragments of humeri and skull partly on top of the former. The remains being intact, it is clear that the dead body has been placed sitting with drawn up legs, and the humeri and skull have fallen into their present positions at the collapse of the body. The skeleton below the N. niche on the chamber floor, was lying on its left side in a slightly contracted position. The fact that, in the same chamber at approximately the same time, three corpses have been buried in three different ways must surely be considered significant of the relatively lax traditions in the burial customs of the period.

Some pieces of an animal's skeleton were found partly mingled with the human remains on the floor, and must be regarded as proofs of the habit of bringing meat and food as tomb-gifts, together with the other burial offerings.

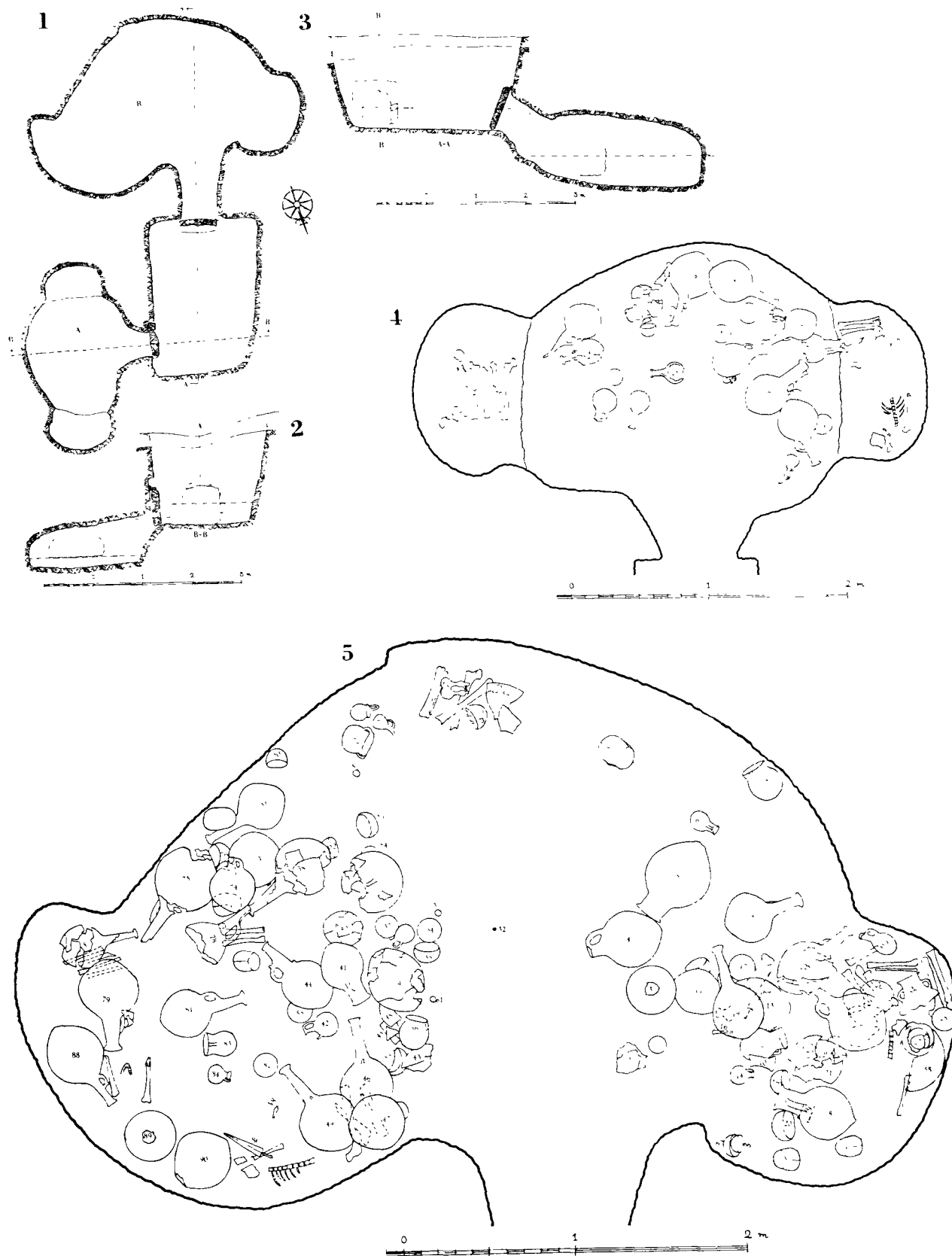

Fig. 44. Lapithos. Tomb 314, Plan (1); Sections B-B, A-A (2, 3); Finds *in situ* (4, 5).

FINDS (GROUPS: PLS. XXVII, 2—4, XXVIII; TYPES: L. OF PL. II)

C h a m b e r A

1. Red Polished III vase, composed of two superimposed pots; the upper is a small globular jug with beaked mouth, and handle from rim to shoulder; the lower is pear-shaped with round base, cylindrical neck, and angular handle from neck to shoulder. Parallel incised zigzag lines on spout and shoulder, and two projections opposite the handles. Height 23.9. Floor.
2. Red Polished II globular jug with round base; tall, tapering neck, splaying rim, and handle from neck to shoulder. Three button-ornaments at root of handle. Piece of rim missing. Height 50.2. Floor.
3. Fragments of a Red Polished II hemispherical bowl. Floor.
4. Red Polished II hemispherical bowl with a string-hole projection at rim. Black rim and inside; rim chipped. Diam. 13.2. Floor.
5. Red Polished III almost hemispherical bowl with inwards-turned rim and a string-hole projection at rim. Black rim and inside. Partly mat surface. Diam. 10.8. Floor.
6. Red Polished II oval jug with round base; tall, cut-away neck, splaying rim, and handle from neck to shoulder; button-ornaments on neck and shoulder. Height 55.3. Floor.
7. Fragments of a Red Polished II incised jug. Floor.
8. Red Polished III oval jug with round base; short, wide neck, splaying rim, and handle from neck to shoulder. Damaged. Height 39.2. Floor.
9. Red Polished II bowl as No. 4. An incised decoration of herring-bone patterns, hatched lozenges and horizontal lines covers the body. Diam. 13.5. Floor.
10. Red Polished II bowl as No. 4. Diam. 14.4. Floor.
11. Fragments of a Red Polished II bowl as No. 4. Floor.
12. Red Polished II globular jug with round base; tall, tapering neck, splaying rim, and handle from neck to shoulder. Button-ornaments on neck and shoulder. Height 42.0. Floor.
13. Red Polished III globular amphora with round base, cylindrical neck, flat rim, and two knobbed handles from neck to shoulder. Impressed ring-ornaments on neck and shoulder. Damaged. Floor.
14. Red Polished II pear-shaped jug with round base, narrow neck, funnel-rim, and handle from rim to shoulder. Bands of horizontal lines around neck and shoulder, and two bands of parallel zigzag lines around body. Height 11.9. Floor.
15. Red Polished II globular jug with round base; tall, slightly tapering neck, wide rim, and handle from neck to shoulder. Button-ornaments on neck and shoulder, and a vertical ridge on handle. Height 57.5. Floor.
16. Red Polished II globular jug with round base; tall, tapering neck, funnel-rim, and a knobbed handle from neck to shoulder. Button-ornaments on neck and shoulder, and a string-hole projection opposite the handle. Height 59.5. Floor.
17. Red Polished II globular jug with round base; tall, tapering neck, flaring rim, and handle from neck to shoulder. Three impressed, small cavities on the handle. Much damaged. Floor.
18. Red Polished III bowl as No. 5. Hatchings around rim; vertical hatched bands, and parallel zigzag lines from rim to base, and bands of horizontal lines around body. Rim chipped; string-hole projection missing; paint worn. Diam. 11.0. Floor.
19. Red Polished II bowl as No. 4. Damaged. Diam. 14.3. Floor.
20. Red Polished III oval jug with round base, tapering neck, splaying rim, and handle from neck to shoulder. Pieces of body missing; partly mat surface. Height 24.5. Floor.
21. Red Polished III pear-shaped jug with round base; tall, tapering neck; wide, flat rim, an angular handle from neck to shoulder, and a small projection opposite the handle. Bands of horizontal lines and hatched lozenges around neck; a band of herring-bone pattern below neck; two friezes of parallel zigzag lines, separated by horizontal lines, around body; herring-bone pattern and short, horizontal lines as supplementary ornaments; hatchings on handle. Surface worn. Height 28.3. Floor.
22. Red Polished III globular jug with round base, cylindrical neck, beaked mouth, handle from rim to shoulder and a projection opposite the handle. Rim missing. Height 23.7. Floor.
23. Red Polished II bowl as No. 4. Diam. 12.8. Floor.
24. Fragments of a Red Polished II globular jug with cut-away neck; paint obliterated. Floor.
25. Red Polished III globular jug with round base; curved, tapering neck, beaked mouth, and handle from rim to shoulder. Projecting button-ornaments on neck and shoulder; an incised rope-pattern between neck and shoulder, and incised, vertical zigzag lines on front of neck and on shoulder. Pieces of body and rim missing; paint partly worn. Height 52.0. Floor.
26. Small, leaf-shaped bronze knife with two edges, rounded end, and flat tang. Length 8.5. Floor.

C h a m b e r B

1. Red Polished II globular jug with round base; tall, narrow, concave neck, splaying rim, and handle from neck to shoulder. Height 53.6. Floor.
2. Red Polished II hemispherical bowl with a string-hole projection at rim. Diam. 9.4. Floor.
3. Red Polished II oval jug with round base; tall, tapering neck; wide, splaying rim, and handle from neck to shoulder. A string-hole projection opposite the handle. Pieces of rim missing. Height 52.9. Floor.
4. Red Polished II globular jug with round base, and handle from neck to shoulder. Pinched relief-lines on shoulder. Upper part of neck missing. Height 43.7. Floor.
5. Red Polished II wide, oval jar with flattened base; short, cylindrical neck, sharply splaying rim, and handle from rim to shoulder. Height 52.0. Floor.

6. Red Polished III pear-shaped jug with round base, cylindrical, cut-away neck, and a curved handle from neck to shoulder. Height 17.2. Floor.
7. Red Polished II globular cooking-pot with round base; wide, cylindrical neck, slightly splaying rim, and two handles from rim to shoulder. Height 23.5. Floor.
8. Red Polished II globular jug with round base; cylindrical neck; splaying rim, and a knobbed handle from neck to shoulder. Relief decorations on neck, handle and shoulder. Height 47.9. Floor.
9. Red Polished II jug as No. 3, but without string-hole. Pinched lines in relief on shoulder. Height 58.7. Floor.
10. Fragments of a Red Polished II large jug. Floor.
11. Red Polished II oval jug with round base, and handle from neck to shoulder. Upper part of neck missing. Height 42.5. Floor.
12. Red Polished II oval amphora with rounded, pointed base, concave neck, splaying rim, and two angular handles from neck to shoulder. Rim chipped. Height 27.5. Floor.
13. Red Polished II amphora as No. 12, but with slightly tapering neck. Height 48.0. Floor.
14. Red Polished II incised, pear-shaped jug with round base; short, cylindrical neck, wide funnel-mouth, and handle from rim to shoulder. Horizontal bands of parallel lines around neck and shoulder; body covered with a skeuomorphic design of concentric circles, connected by bands of parallel lines, running in horizontal and oblique direction. Height 14.2. Floor.
15. Red Polished II bowl as No. 2. Diam. 13.5. Floor.
16. Bronze tweezer with loop-shaped top. Length 12.4. Floor.
17. Red Polished II bowl as No. 2. Diam. 14.1. Floor.
18. Red Polished II amphora as No. 13, but with a ridge between neck and shoulder. Height 47.2. Floor.
19. Red Polished II bowl as No. 2. Diam. 13.0. Floor.
20. Red Polished II bowl as No. 2. Diam. 15.0. Floor.
21. Fragments of a large Red Polished II jug. Floor.
22. Fragments of a large Red Polished II jug. Floor.
23. Red Polished II globular jug with round base; tall tapering, neck; wide, splaying rim, and handle from neck to shoulder. Height 57.8. Floor.
24. Red Polished II deep, globular bowl with round base, splaying rim, an upright-standing, horizontal handle on rim, and an upwards-turned, tubular spout opposite the handle. Height 16.2. Floor.
25. Red Polished III jug as No. 6. Height 22.1. Floor.
26. Fragments of a Red Polished II amphora with wide, concave neck, splaying rim, and two handles from neck to shoulder. A relief decoration of a stag on shoulder. Floor.
27. Red Polished III pear-shaped askos with round base and an obliquely placed, cylindrical neck; splaying rim, and a small handle from neck to back. Horizontal bands of parallel lines around neck; body covered with a skeuomorphic design of vertically antithetic, concentric semicircles, connected by a pattern of bands, running vertically and horizontally and forming a network. Height 10.0. Inside No. 29.
28. Red Polished II bowl as No. 2. A band of herring-bone pattern around rim; parallel zigzags below rim; body covered with an irregular design of antithetic, concentric semicircles; short, horizontal lines, and vertical, parallel zigzags. Diam. 11.1. Floor.
29. Red Polished II cooking-pot as No. 7, but with concave neck. Pieces of rim, neck and shoulder, and one handle missing. Height 16.9. Floor.
30. Red Polished II hemispherical bowl with an upwards-curved tubular spout, and a small handle attached to spout; a large string-hole projection at rim opposite the spout. Diam. 20.2. Floor.
31. Flat ring-shaped amulet of milk-stone. Diam. 2.7. Floor.
32. Spherical bead of milk-stone. Diam. 1.9. Floor.
33. Fragments of a large Red Polished II jug. Floor.
34. Red Polished II bowl as No. 2. Diam. 14.0. Floor.
35. Red Polished II bowl as No. 2. A horizontal band of parallel lines around rim; body divided by similar vertical bands in five fields, decorated with parallel zigzags and oblique lines. Diam. 12.9. Floor.
36. Red Polished II incised jug as No. 14, but with a low, broad projection opposite the handle; decorated as No. 14, but with dotted and hatched lines as filling ornaments. Height 15.2. Floor.
37. Red Polished II incised hemispherical bowl. A horizontal band of parallel lines around rim; body covered with vertical bands of parallel straight and dotted lines. Diam. 12.8. Floor.
38. Fragments of a large Red Polished II jug with tapering neck and wide, splaying rim. Floor.
39. Fragments of a large Red Polished II jug. Floor.
40. Fragments of a large Red Polished II jug. Floor.
41. Red Polished II oval amphora with pointed, rounded base; concave neck, splaying rim, and two angular handles from neck to shoulder. Two bands of horizontal lines, one band of parallel zigzags, and one band of concentric circles around neck. A network of lozenges on the shoulder, and a girdle of concentric circles, connected by oblique and horizontal bands of parallel lines around belly. Zigzags and scratchings on the handles. Height 38.1. Floor.
42. Red Polished II jug as No. 36, but with taller neck, and with an idol-shaped projection opposite the handle. Rich filling ornaments of hooked and inverted chevrons. Pieces of rim missing. Surface worn. Height 20.5. Floor.
43. Fragments of a large Red Polished II bowl with flat base. Floor.
44. Red Polished II ovoid jug with round base; tall, tapering neck; wide, splaying rim and a knobbed handle from neck to shoulder. A projection opposite the handle. Pinched lines in relief on shoulder. Height 50.6. Floor.
45. Red Polished II large bowl with flattened base; a ledge-handle below rim, and an open spout opposite the handle. Much damaged. Diam. 49.4. Floor.
46. Red Polished II oval jug with round base; tapering neck, wide funnel-rim, and handle from neck to shoulder. An upright-standing projection opposite the handle.

- Button-ornaments on neck. Piece of body missing. Height 58.5. Floor.
47. Red Polished II globular jug with round base; short, cylindrical neck; splaying rim, and handle from neck to shoulder. Height 57.2. Floor.
48. Fragments of a large Red Polished II jug. Floor.
49. Red Polished II globular jug as No. 3. Height 58.2. Floor.
50. Red Polished II bowl as No. 2. Rim chipped. Diam. 11.5. Floor.
51. Red Polished II globular jug with round base, cylindrical neck; wide, splaying rim, and handle from neck to shoulder. Height 52.5. Floor.
52. Red Polished II bowl as No. 2. Diam. 12.0. Floor.
53. Red Polished II bowl as No. 2. Diam. 13.6. Floor.
54. Red Polished II bowl as No. 2. Diam. 9.3. Floor.
55. Red Polished II bowl as No. 2. Diam. 13.6. Floor.
56. Red Polished II cooking-pot as No. 29. Damaged. Height 15.8. Floor.
57. Red Polished II bowl as No. 2. Damaged. Diam. 14.3. Floor.
58. Red Polished II large, globular jug with round base. Neck and handle missing. Damaged. Floor.
59. Red Polished II large jug as No. 58. Relief-lines on shoulder. Neck and handle missing. Damaged. Floor.
60. Red Polished II bowl as No. 2. Damaged. Diam. 14.5. Floor.
61. Red Polished incised, flat, conical spindle-whirl. Diam. 3.7. Floor.
62. Red Polished III coupled vase, consisting of two small jugs with beaked mouths, and a common, twisted fork-handle. Zigzag bands around necks and bodies. Height 16.9. Floor.
63. Red Polished II jug as No. 42, but without projection; decorated as No. 36. Damaged. Height 11.5. Floor.
64. Red Polished II jug as No. 36, but with taller neck. Piece of handle missing. Height 14.2. Floor.
65. Red Polished III jug as No. 6. Height 21.0. Floor.
66. Red Polished II bowl as No. 2. Diam. 9.5. Found in No. 67.
67. Red Polished II bowl as No. 2. Diam. 13.6. Floor.
68. Two straight bronze pins with flat button-heads. Length 15.4. Floor.
69. Bronze dagger with straight sides, pointed end, two edges, midrib, cuttings near the tang, and solid, hooked tang. Length 30.4. Floor.
70. Red Polished III deep, globular bowl with round base; splaying rim; high, vertical handle from rim to body, and a button-ornament in relief on shoulder opposite the handle. Height 17.2. Floor.
71. Red Polished II incised jug of the same shape as No. 36, but with beaked mouth. Bands of horizontal lines flanking a band of antithetic, concentric semicircles around neck, and similar ornaments in a broad band around belly. Height 15.5. Floor.
72. Red Polished II cooking-pot as No. 29. Height 16.0. Floor.
73. Red Polished II jug as No. 3. Rim missing. Height 53.2. Floor.
74. Red Polished II jug as No. 1. Height 49.8. Floor.
75. Fragments of a Red Polished II large, globular jug with round base, tapering neck, and a knobbed handle from neck to shoulder. Floor.
76. Red Polished II bowl as No. 2. Paint worn. Diam. 13.2. Floor.
77. Red Polished II bowl as No. 2. Diam. 10.8. Floor.
78. Red Polished II large, globular jug with round base; tall, cylindrical, cut-away neck, and handle from neck to shoulder. Snake ornaments in relief on neck. Height 53.8. Floor.
79. Red Polished II globular jug with round base, cylindrical neck, splaying rim, and handle from neck to shoulder. Rim chipped. 51.8. Floor.
80. Red Polished spindle-whirl as No. 61. Diam. 3.5. Floor.
81. Red Polished II globular jug with tapering neck, wide funnel-rim, and handle from neck to shoulder. Button-ornaments on shoulder. Height 50.4. Floor.
82. Red Polished II bowl as No. 2. Diam. 13.2. Floor.
83. Red Polished II cooking-pot as No. 29. Height 15.7. Floor.
84. Red Polished II jug as No. 14. Height 11.9. Floor.
85. Small bronze knife with concave sides, two edges, no midrib, wide shoulder, and flat, tapering tang with rounded top and one rivet-hole. Point missing. Length 6.6. Floor.
86. Bronze dagger as No. 69. Length 29.5. Floor.
87. Fragments of a Red Polished II jug. Floor.
88. Fragments of a Red Polished II globular jug with tapering neck, splaying rim, and handle from neck to shoulder. Height 55.5. Floor.
89. Red Polished II jug as No. 3. Neck and handle missing. Height 37.6. Floor.
90. Red Polished II jug as No. 44, but without string-hole handle. Handle missing. Height c. 60.3. Floor.

CHRONOLOGY

The diagram seems to show that the whole of Chamber B is earlier than Chamber A. The first group contained only two Red Polished III vases, and can be dated to the end of the E. C. II period; the second group contains some specimens of early Red Polished III Ware, which dates these burials to the very beginning of E. C. III. Chamber A contains about one third Red Polished III Ware and is evidently slightly later than the second group of Chamber B.

The diagram gives a summary of the Object Register and observations mentioned in connection with the distribution of the pottery.

	Pottery							Bronze				Stone	Terracotta
	R. P. II			R. P. III				Knives	Daggers	Tweezer	Pins	Amulets	Spindle-whirls
Chamber A	2. 3. 4. 6. 7. 9	1. 5. 8. 13	26										
	10. 11. 12. 14. 15. 16	18. 20. 21. 22											
	17. 19. 23. 24	25											
	-16	-9	-1										
Chamber B 1st group	18. 19. 20. 21. 22. 23	25. 27											
	24. 26. 28. 29. 58. 87												
	88												
	-13	-2											
2nd group	1. 2. 3. 4. 5. 7	6. 62. 65. 70	85	69. 86	16	68. 68	31. 32	61. 80					
	8. 9. 10. 11. 12. 13												
	14. 15. 17. 30. 33. 34												
	35. 36. 37. 38. 39. 40												
	41. 42. 43. 44. 45. 46												
	47. 48. 49. 50. 51. 52												
	53. 54. 55. 56. 57. 59												
	60. 63. 64. 66. 67. 71												
	72. 73. 74. 75. 76. 77												
	78. 79. 81. 82. 83. 84												
	89. 90												
	-62	-4	-1	-2	-1	-2	-2	-2					

TOMB 315 (Figs. 45: 1-2; 46: 1-2)

	SIZE			
	Length	Width	Depth	Height
Dromos	2.83	1.92	1.32	—
Stomion A	0.46	1.10	—	0.46
Chamber A	4.15	4.55	—	1.25
Stomion B	0.75	0.84	—	0.48
Chamber B—C	1.86	6.15	—	1.50
Stomion C	0.86	0.65	—	0.55

SHAPE

The shape of the dromos of this tomb is very irregular, in part, due to the work of stone cutters in modern time. The N. part is defaced and used as a quarry; thus the steps leading down to the bottom are secondary. To judge from the plan of the floor, this end has originally been apsidal with slightly tapering walls. The entrance C, leading down to the W. part of Chamber B—C, was found without door-packing, and has evidently been reshaped in modern times. The original W. edge of the dromos must be reconstructed, by aid of the W. corner of the short S. side and the plan of the floor, to a roughly vertical plan above

the threshold of Stomion C. This edge has been used as the starting point for the workmen of the quarry, who have thus struck upon the door stone and the roof of the stomion from above. The stone was removed and the stomion received its present shape, but as the chamber was filled with mud and debris, they never tried to enter it. The continued work gave the long W. side of the dromos its irregular shape.

Stomion A has also been subjected to the stone cutters' operations. They found it when working at the short N. side of the dromos and broke the flat door stone, but a compact filling inside obstructed the entrance. The chamber is large and oval, provided with a series of small niches above the level of the floor. From a niche on the S. side, connection with Chamber B—C was involuntarily established, by the partial collapse of the thin separating wall.

Stomion B was never found by the stone cutters, and was quite intact, when found by us. It was covered by an irregular flat slab of local limestone, wedged by small chips of the same material. The tunnel-shaped stomion widens inwards and slopes abruptly down to the level of the chamber floor. Round the door stone a shallow moulding was cut, outlining the stone.

The shape of Chamber B—C is very complicated. Originally it was planned as a "kidney-shaped" chamber with niches on the short sides, but while cutting it, the plan was gradually rearranged because of the hindrance, presented by the surrounding tombs. The back wall fell in and connected the chamber with the dromos of Tomb 306 (see above p. 57). The damage was repaired by means of a stone wall and the stability of the construction re-established. Also the immediate neighbourhood of Chamber A, the separating wall of which threatened to collapse prevented further advance on the short E. side. Consequently the main space was increased in the opposite direction, to such an extent as to render it impossible for the cutters of Chamber C to avoid a collision with the larger chamber. The result of all the cutting was, consequently, a more or less coherent series of caves; Chambers B and C can be considered as a unit. The floor of the latter lies on a slightly higher level than that of the former, and it functions rather as a large niche than a separate chamber.

A small, circular cupboard was found in the dromos to the South of Stomion A.

STRATIFICATION

In the dromos the operations of the stone cutters were clearly traceable in the stratification of the filling. The area in front of Stomion A and the greater part of the dromos, including the section close to Stomion C, was dug through and the loose earth was mixed with large chips from the quarry. Only in front of the central chamber, was the original filling intact, and there it was stratified in two layers of *chavara*, both containing some potsherds of late Red Polished III Ware. The intact filling was not sufficiently preserved to allow of a detailed study of its significance, regarding the different burials in the chambers, but was enough to show that, even before the work of the modern stone cutters, the dromos had been partly emptied and refilled.

Chamber A was filled to the roof with a mass of extraneous matter, emanating from the

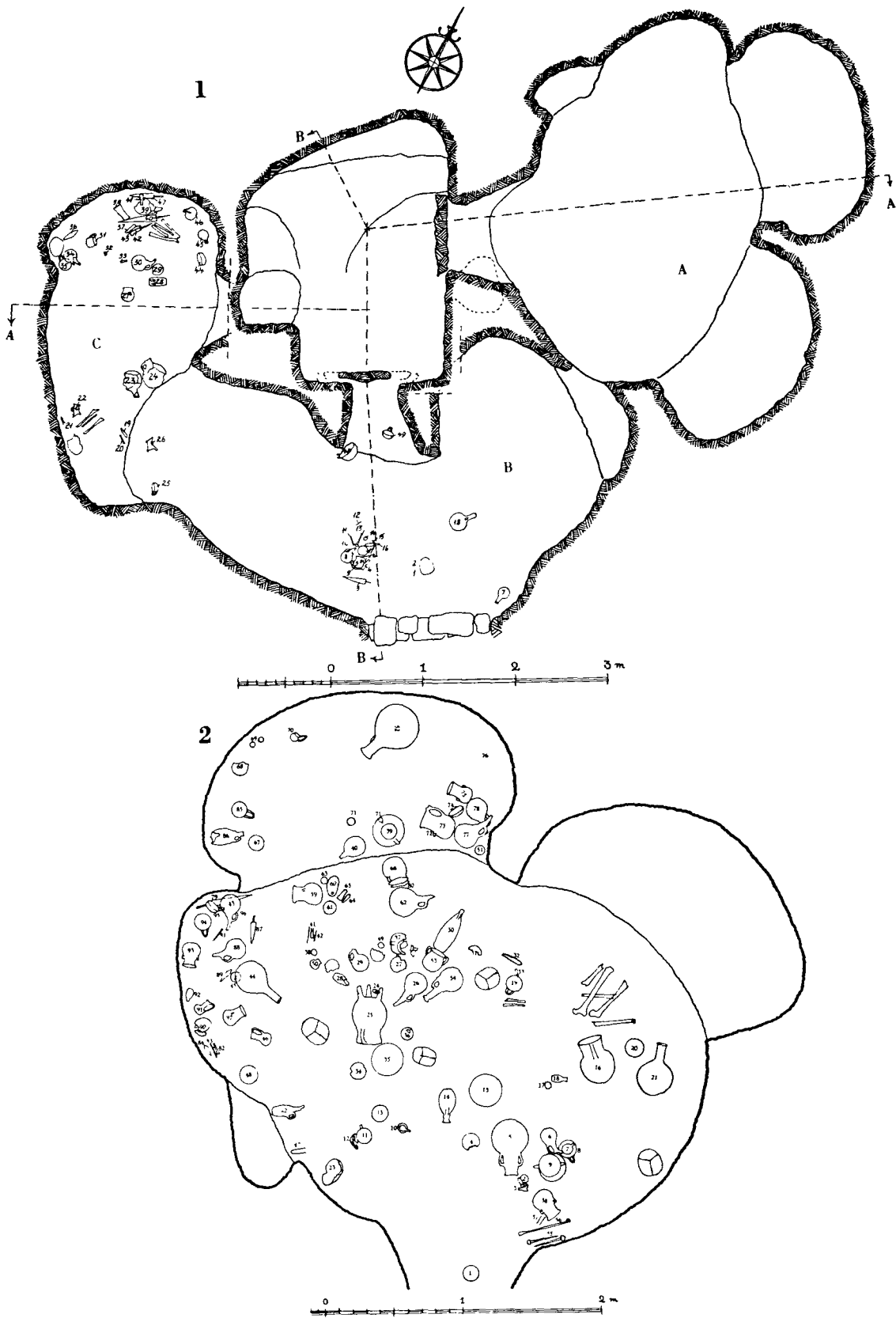

Fig. 45. Lapithos. Tomb 315, Plan (1); Chamber A with finds *in situ* (2).

erosion of roof and walls, and from mud and water which had poured into the chamber through the stomion and the broken door stone. The filling was stratified in four main layers, described from the top as follows:

- 1) A layer, about 0.50 m. thick, of finely silted clay mixed with some organic matter from the surface of the earth.
- 2) A layer, about 0.10 m. thick, of debris from the roof, consisting of large pieces of *chavara* and eroded rock.
- 3) A layer, about 0.50 m. thick, of silted clay resembling the top stratum, but containing a considerable amount of rock and streaks of darker culture earth from the bottom layer.
- 4) A dark layer, about 0.10 m. thick, of culture earth from the burials. This stratum was in a moist and silted state.

This stratification was clearly traceable in the section close to the stomion, but its entire extent could not be seen, as a heavy rain during the excavation filled dromos and chamber with water, which disturbed the original stratigraphy. The latter part of the digging in the chamber was very much obstructed by these difficult conditions, especially as the whole series of chambers threatened to collapse under the destructive influence of the flood. Also the contents of the tomb were moved and the levels of the finds are not conclusive as to their relative dates.

The sum of the skeletal remains indicate that six burials had taken place in the chamber, but none was found *in situ*.

Chamber B—C was excavated under better conditions, and could be more exactly studied. The tomb was entered from the back wall of the central chamber which was connected to the dromos of Tomb 306 (see above). The chamber was entirely filled with masses of extraneous matter, stratified as follows:

- 1) Silted clay, about 0.55 m. thick, mixed with small streaks of debris from the roof.
- 3) A layer, about 0.10 m. thick of *chavara*, fallen from the roof.
- 3) A layer of silted clay, about 0.50 m. thick, of the same composition as Layer 1.
- 4) Burial strata here and there on the chamber floor, in a very decomposed state.

The mud and water (Layers 1 and 3) which had permeated into the chamber, have brought disorder among the deposits, and a good many of the pots were certainly not exactly *in situ*. Upon Layer 2 it could be stated that at least three burials had taken place close to the back wall. The remains were not found *in situ*, but it is evident that they were brought into the chamber after the partial collapse of the roof, and consequently, belong to a later period. The finds in question are Nos. 3—18.

The rest of the tomb-gifts were found in the floor stratum, or resting directly on the floor, where also the remains of two burials could be seen, one in the E. and one in the N. W. part of the chamber.

BURIALS

Because of the bad state of preservation of the tomb as a whole, it was impossible to reconstruct with any certainty the original positions of the dead bodies.

FINDS (GROUPS: PLS. XXIX, XXX; TYPES: L. OF PL. II)

Chamber A

1. Black Polished hemispherical bowl with a string-hole at rim. Incised bands of lattice-lozenges around body. Diam. 10.2. + 40.
2. White Painted III deep bowl with round base; short, wide neck, flat rim, and a high handle from rim to body. Encircling lines around neck and body; transverse lines on rim and handle; hatched triangles around body; a wavy line below belly, and an encircled wheel-ornament on base. Height 7.7. Floor.
3. White Painted II bottle; badly damaged. Floor.
4. White Painted III shallow bowl with round base, and a horizontal handle at rim. Hatched triangles around rim; a wavy line inside rim; a framed band of parallel, oblique lines on base, and a cross of straight and wavy lines inside. Not complete. Diam. 12.5. Floor.
5. Red Polished III oval amphora with round base; tapering, convex neck, splaying rim, and two handles from neck to shoulder. Height 39.8. Floor.
6. White Painted III pear-shaped jug with flattened base, cylindrical neck, beaked mouth, and handle from rim to shoulder. Vertical lines on neck; broad, framed lattice-bands from neck to base; a framed, wavy line from mouth to shoulder; a wavy line around base, and a circular dot on base. Height 21.8. + 6.
7. Red Polished IV deep bowl with flattened base; short, wide neck, and a high handle from rim to body. Height 8.5. + 6.
8. Red Polished III shallow bowl with round base, and a horizontal handle at rim. Diam. 12.6. + 2.
9. Red Polished III oval cooking-pot with wide neck, slightly splaying rim, three legs, and two handles from rim to shoulder. Oblique scores on the handles. Height 31.6. Floor.
10. White Painted II deep bowl with round base, splaying rim, and a high, knobbed handle from rim to body. Lattice-bands from rim to base, red polished base, and transverse lines on handle. Height 9.6. Floor.
11. Black Polished shallow bowl with round base, slightly inwards-turned rim, and handle from rim to body. An irregularly wavy line around rim; encircling lines below rim and around base; hatched lozenges and lattice-bands with concentric circles around body, and short, wavy lines as filling ornaments. Diam. 10.2. Floor.
12. White Painted II bowl as No. 8; badly damaged. Floor.
13. Red Polished III hemispherical bowl with a small projection at rim. Diam. 12.0. Floor.
14. White Painted II lentoid bottle with flat base; tall, tapering neck, splaying rim, and a twin-handle from neck to body. Decoration obliterated. Height 24.5. — 26.
15. Red Polished III shallow bowl with round base, a string-hole handle at rim, and pinched projections on rim. A broad, framed band of hatched lozenges and concentric circles below rim, and a minute pattern of concentric circles; framed, hatched lozenges; vertical lattice-bands; framed zigzag bands, and parallel, wavy lines covering the body. Diam. 24.1. Floor.
16. Red Polished III oval cooking-pot with round base; wide, cylindrical neck, and two handles from rim to body. Height 32.5. — 26.
17. Red Polished almost spherical spindle-whirl with flattened ends. Incised zigzag bands and concentric circles. Diam. 5.0. — 42.
18. White Painted III bottle as No. 14, but with a small string-hole handle from neck to body. Encircling lines around rim and neck, vertical bands of hatched lozenges from neck to base, and crossed lines on base. Paint worn. Height 11.4. — 38.
19. Red Polished III bowl as No. 8. Diam. 12.0. — 4.
20. White Painted III bowl as No. 8. Parallel, straight and wavy lines, meeting in a cross inside and outside; hatched triangles around rim. Handle missing. Diam. 13.5. — 40.
21. Red Polished III globular jug with round base; cylindrical neck; small, splaying rim, and handle from neck to shoulder. Incised lines and impressed dots on neck; scores on handle. Height 37.9. — 29.
22. White Painted III flat bottle with flat base, two cylindrical necks with beaked mouths; a handle from top of bottle to body; string-hole projections on the sides and in front of necks. Encircling lines around necks, bands of wavy lines and chess-boards patterns around body, and crossed lines on base. Height 23.2. — 2.
23. Red Polished IV shallow bowl with round base, and a string-hole handle at rim. Rim chipped. Diam. 20.4. — 40.
24. White Painted III bottle as No. 18. Height 10.2. — 32.
25. Red Polished III cooking-pot as No. 9. Height 43.4. — 38.
26. White Painted II pear-shaped jug with round base, cylindrical neck, beaked mouth, handle from neck to shoulder, and string-hole projections opposite handle, and on rim. Straight and wavy lines around neck; wavy lines inside the spout; broad lattice-bands and wavy lines from neck to base, and an encircled cross of wavy lines on base. Height 31.3. 30.
27. Red Polished III shallow bowl with round base, and a handle from rim to body. Not complete. Diam. 11.5. — 1.
28. Fragments of a White Painted III bottle. — 1.
29. White Painted II pear-shaped jug with cylindrical neck, round base, splaying rim, oblique mouth, handle from rim to shoulder, and a small projection opposite the handle. Decoration as No. 26, but with concentric circles on base, and a wavy line on handle. Paint worn. Height 18.2. — 1.
30. White Painted II oblong, flat bottle with flat base; narrow, cylindrical neck, handle from neck to shoulder, and small projections opposite the handle, and along the sides. Encircling lines around neck; square and oblong chess-board patterns covering the body; a wavy line around base, and crossed lines on base. Pieces of neck and rim missing. Height 33.9. — 14.

31. Fragments of White Painted III bowl as No. 8. Decoration obliterated. — 16.
32. Leaf-shaped bronze knife with two edges, rounded top and two rivet-holes through top. Badly corroded. Length 15.7. — 3.
33. Oblong whetstone. Length 5.5. — 3.
34. Red Polished II hemispherical bowl with a string-hole projection at rim. Rim chipped. Diam. 13.3. — 14.
35. Red Polished IV wide, shallow bowl with round base, and a string-hole projection at rim. Diam. 24.6. — 30.
36. Red Polished III globular jug with round base; neck and handle missing. Paint worn. Height 8.5. — 15.
37. Fragments of a White Painted II jug with spout. — 15.
38. Red Polished spindle-whirl as No. 17. Diam. 4.3. Floor.
39. Red Polished III pear-shaped amphora with round base; short, concave neck, splaying rim, and two vertical handles on shoulder. Incised zigzag lines on neck, shoulder and handles. Paint obliterated. Height 39.1. — 10.
40. Red Polished III oval jug, with round base, cylindrical neck, beaked mouth, handle from rim to shoulder, and a string-hole projection opposite the handle. Pieces of rim missing; paint worn. Height 22.8. — 10.
41. Bronze tweezer with curved top. Length 6.8. Floor.
42. Bronze pin with thickening head, and an eyelet through the middle of the pin. Length 8.8. Floor.
Bronze needle with flattened head, pierced by an eyelet. Length 12.7. Floor.
43. White Painted II jug as No. 26. Height 25.7. — 15.
44. Red Polished III oval jug with round base, cylindrical neck, and handle from neck to shoulder. Incised lines on handle. Rim missing. Height 37.2. — 18.
45. Black Polished, globular bottle with round base; narrow, cylindrical neck, splaying rim, and a small handle from neck to shoulder. Incised, straight and wavy lines around shoulder. Height 8.6. — 20.
46. White Painted II squat, conical jug with round base; tall, concave neck, slightly splaying rim, and a high handle from rim to shoulder. Encircling lines around neck; lattice-triangles around shoulder, and crossed lines on base. Top of handle missing; paint worn. Height 14.7. — 22.
47. Bronze tweezer as No. 41, but with widening arms. Length 10.8. — 2.
48. Red Polished II bowl as No. 34. Diam. 13.3. — 2.
49. Black Slip spindle-whirl as No. 17. Diam. 3.8. Floor.
50. Coarse Ware, globular jug with round base, concave neck, slightly splaying rim, and handle from rim to shoulder. Surface worn. Height 8.9. Floor.
51. Red Polished III globular bottle with round base, tapering neck, splaying rim, and a small handle from neck to shoulder. Height 8.7. — 25.
52. Red Polished III oval jug with round base; cylindrical neck, slightly splaying rim, oblique mouth, handle from neck to shoulder, and a string-hole projection opposite the handle. Zigzag lines on neck, shoulder, and handle. Height 47.3. — 2.
53. Coarse Ware cooking-pot with round base, widening neck, and two angular handles from rim to shoulder. Height 16.3. — 20.
54. Black Slip I globular jug with round base; tall, tapering neck, splaying rim, a knobbed handle from neck to shoulder, and a string-hole projection opposite the handle. Oblique, parallel lines on handle. Paint worn. Height 32.3. — 30.
55. Two thick, solid bronze pins with "mushroom-heads" and eyelets through the middle of the pins. Length 23.7. Floor.
56. Bronze spatula with long handle ending in a spiral in which a ring is fixed; flat, widening end. Length 37.9. Floor.
57. Plain, straight bronze pin without head. Length 7.2. Bronze needle with flat head, pierced by an eyelet. Length 9.0. Floor.
58. White Painted III globular amphora with round base; wide, cylindrical neck, flat rim, and two angular handles from neck to shoulder. Framed, wavy lines and hatched lozenges around neck and base; hatched triangles around shoulder, zigzag lines on rim; two wavy lines inside rim; a cross and an encircled dot on base. Height 20.6. Floor.
59. Red Polished III pear-shaped amphora with round base, cylindrical neck; small, splaying rim, and two handles from neck to shoulder. A framed frieze of zigzag lines and concentric circles around neck; vertical, hatched bands, chess-boards patterns, hatched lozenges, and concentric circles on body; a wavy line around belly; encircling lines and small circles around base. Rim chipped; paint worn. Height 21.3. Floor.
60. Oval loom-weight of heavy calcareous stone with a hole at top. Scores along the sides. Length 15.1. Floor.
61. Fragments of a Red Polished III bowl. Diam. 10.1. Floor.
62. Red Polished III pear-shaped jug with round base, tapering neck, beaked mouth, and handle from rim to shoulder. Encircling lines around rim and neck, and vertical straight and wavy lines from neck to base. Height 33.4. Floor.
63. Black Polished spindle-whirl as No. 17. Incised concentric circles and lattice-bands on the sides. Diam. 4.7. Floor.
64. Leaf-shaped bronze knife with two edges, concave sides, rounded end and top, low midrib and three rivet-holes through top. Length 8.0. Floor.
65. Bronze axe with widening sides and broad, convex edge. Length 8.3. Floor.
66. Red Polished III globular cooking-pot, with round base; wide, cylindrical neck, slightly splaying rim, and two handles from rim to shoulder. Incised lines on handles. Height 19.5. Floor.
67. White Painted III bowl as No. 4. Crossed lines meeting in an encircled dot inside; a band of parallel, oblique lines around rim, and straight lines on base. Handle missing. Diam. 10.7. Floor.
68. Fragments of a Red Polished II bowl as No. 34. Floor.
69. Red Polished biconical spindle-whirl with zigzag incisions on the sides. Diam. 3.4.
Black Polished spindle-whirl as No. 17. Crossed incised lines on the sides. Diam. 3.9. Floor.

70. White Painted III bowl as No. 7. Encircling lines around neck and belly; hatched triangles and a wavy line around body, an encircled cross on base, and transverse lines on handle. Height 8.4. Floor.
71. Squat globular spindle-whirl of white calcareous stone. Diam. 5.7.
Red Polished spindle-whirl as No. 17. Irregular incisions on the sides. Diam. 3.7. Floor.
72. Red Polished II hemispherical bowl. Not complete. Floor.
73. Red Polished IV globular jug with round base; wide, cylindrical neck, splaying rim, a knobbed handle from rim to shoulder, and a string-hole projection opposite the handle. Rim chipped. Height 24.7. Floor.
74. White Painted II bowl as No. 4. Encircling wavy lines inside, and an encircling dot in bottom; parallel, oblique lines around rim, framed wavy line on base, and transverse lines on handle. Piece of handle missing. Diam. 11.7. — 16.
75. Red Polished IV squat, globular amphora, with flat base; wide, tall neck; flat rim, and two angular handles from neck to shoulder. Body decorated in very low relief with a pattern consisting of lattice-lozenges, zigzag lines, and crossed lines. Height 17.9. Floor.
76. Fragments of a Red Polished II jar. Floor.
77. White Painted II jug as No. 26. Height 31.9. Floor.
78. Red Polished III oval jug with round base, tapering neck, beaked mouth, and handle from rim to shoulder. An incised, wavy line on handle. Rim chipped; paint worn. Height 26.3. Floor.
79. Leaf-shaped bronze dagger with two edges, pointed end, rounded top, narrow cuttings near the tang, midrib, and solid, hooked tang. Length 38.7. Floor.
80. Leaf-shaped bronze knife as No. 64. Length 1.36. Floor.
81. Bronze pin as No. 42. Length 11.7. Floor.
82. Fragments of a bronze tweezer as No. 41. Length 8.3. Floor.
83. Bronze needle as No. 57. Length 11.0. Floor.
84. Bronze knife as No. 64 but with convex sides. Length 9.3. Floor.
85. White Painted III bowl as No. 4. Decoration obliterated. Diam. 11.0. Floor.
86. White Painted II flat bottle with flat base; narrow, cylindrical neck, splaying rim, a knobbed handle from neck to shoulder, and a string-hole projection opposite the handle. Bands of wavy lines and lattice-lozenges around neck and body; vertical bands of lattice-squares below handle and as front ornament; transverse lines on handle. Damaged. Height 26.0. Floor.
87. Bronze dagger as No. 79. Length 19.2. Floor.
88. Red Polished III globular jug with round base, cylindrical neck, beaked mouth, and handle from rim to shoulder. Paint worn. Height 24.4. Floor.
89. Bronze knife as No. 64. Length 12.0. Floor.
90. Fragments of a White Painted III bowl as No. 4. Floor.
91. White Painted III squat jug with round base; tall, cylindrical neck, splaying rim, and high handle from rim to shoulder. Decoration obliterated. Height 12.8. Floor.
92. White Painted II bottle as No. 18. Decoration almost obliterated. Height 9.0. Floor.
93. Red Polished IV amphora as No. 58. Alternating zigzag and straight lines around rim, neck, and body. Height 16.1. Floor.
94. White Painted III bowl as No. 4; decorated as No. 67. Diam. 11.6. Floor.
95. White Painted III bowl as No. 4. A band of parallel, oblique lines around rim; crossed lines and circles on base, and a wheel-ornament inside; transverse lines on handle. Diam. 10.8. Floor.
96. Fragments of a Red Polished III bowl. Floor.
97. White Painted III amphora as No. 58. Bands of wavy lines and lattice-triangles around neck and body. Decoration much worn. Height 16.5. Floor.

C h a m b e r B—C

1. Red Polished III shallow bowl with a string-hole handle at rim. A framed band of hatched lozenges and concentric semicircles around rim; concentric circles and hatched lozenges on body. Not complete. Diam. 17.1. Floor.
2. Red Polished III bowl as No. 1. A framed band of hatched lozenges and concentric circles around rim; lattice-bands; concentric circles and hatched lozenges on body. Not complete. Diam. c. 16.0. Floor.
3. Bronze dagger with two edges, pointed end, midrib, straight sides, rounded top with deep cuttings near the tang, and hooked, solid tang. Length 30.8. — 26.
4. Bronze axe with widening sides, and broad, curved edge. Length 13.2. — 21.
5. White Painted III globular amphora with round base; wide, tapering neck, stilted rim, and two small, profiled handles from neck to shoulder. Oblique, parallel lines on rim; a chess-board pattern around neck and body, and crossed straight and wavy lines on base. Paint partly worn. Height 12.1. — 24.
6. White Painted II pear-shaped jug, with round base, cylindrical neck, beaked mouth, a handle from rim to shoulder, and string-hole projections on rim and opposite the handle. Straight and wavy lines around the neck; broad lattice-bands and wavy lines from neck to belly, a wavy line between belly and base, and red polished base. Height 31.7. — 32.
7. Red Polished III globular jug, with round base, and cylindrical neck; handle from neck to shoulder. Rim and handle missing. Height 17.7. — 29.
8. Red Polished III jug as No. 6, but without string-hole projections at rim. Height 21.3. — 26.
9. Bronze tweezer with rounded top. Length 6.4. — 32.
10. Fragment of a bronze tweezer; badly corroded. — 32.
11. Bronze needle with flattened head, pierced by an eyelet. Length 12.0. — 32.
12. Upper part of a bronze pin with button-head. Length 7.5. — 32.
13. Bronze pin with large "mushroom head", an eyelet through middle of pin, and profiled ridges on both sides of the eyelet. Length 21.1. — 32.

14. Black Polished spindle-whirl of slightly biconical shape. Incised lines on the sides. Not complete. — 32.
15. Bronze awl with square section, pointed end, and tapering tang. Bent. Length 9.1. — 32.
16. Leaf-shaped bronze knife with pointed end, convex sides, rounded top, low midrib, and three rivet-holes through top. Length 14.4. — 32.
17. Red Polished III globular cooking-pot with round base, flat rim, and two string-hole handles from rim to shoulder. Encircling lines around rim and body, a zigzag band below neck, and short, vertical lattice-bands and concentric circles around belly. Height 9.2. — 32.
18. White Painted II jug as No. 8. Horizontal lines around neck; broad, framed lattice-bands, zigzag lines, and wavy lines from neck to base; concentric circles on base, and a vertical wavy line on handle. Height 30.2. — 36.
19. Leaf-shaped bronze knife with pointed end, concave sides, low midrib, rounded tang, two edges, and two rivet-holes through tang. Length 12.2. Floor.
20. Bronze awl as No. 15. Traces of a horn handle. Length 10.2. Floor.
21. Bronze awl as No. 15. Length 11.6. Floor.
22. Red Polished III animal-shaped vase with four legs, two horns, a small tail, and a basket-handle on the back. Hind legs and piece of right horn missing. A network of plain and hatched lozenges covers the body. Height 12.7. Floor.
23. Red Polished III oval jug with round base, cylindrical neck, slightly splaying rim, and handle from neck to shoulder. Not complete. Height 29.5. Floor.
24. Red Polished III globular jug, with round base, cylindrical neck, slightly splaying rim, oblique mouth, handle from neck to shoulder, and a string-hole projection opposite the handle. Relief-lines around neck and shoulder. Not complete. Height 30.7. Floor.
25. White Painted III shallow bowl with round base, and handle from rim to body. Decoration obliterated. Diam. 10.5. Floor.
26. White Painted III animal-shaped vase, with bird-shaped body, four legs, long neck, two ears, and two baskets hanging on the back. Head missing. Parallel lines on body and neck, and crossed lines on belly and in the baskets. Length 14.4. Floor.
27. White Painted III globular amphora with round base; wide, cylindrical neck, slightly splaying rim, and two small handles from neck to shoulders. Bands of parallel zigzag lines, hatched triangles and wavy lines around neck, shoulder, and belly; oblique lines on rim; four circles and crossed lines on base. Height 13.4. Floor.
28. Red Polished III flat idol in the shape of a bed with two lying figures. Above the heads of the figures are two arched bows. The cover of the bed is decorated with hatched lozenges and wavy lines forming an irregular pattern, and the back is decorated in a similar way. One bow missing. Paint and surface worn. Length 19.9. Floor.
29. Black Polished shallow bowl with a small projection at rim. A band of hatched lozenges around rim; parallel zigzag lines and hatched lozenges around body, and concentric circles on base. Diam. 11.0. Floor.
30. Red Polished III jug as No. 8. Incised, vertical zigzag lines on neck, shoulder and handle. Height 28.5. Floor.
31. White Painted III deep bowl, with round base; small, vertical rim, and a high handle from rim to body. Hatchings around shoulder; parallel zigzag lines around base; framed, parallel, oblique lines on handle, and inside the rim; a circle on base. Height 16.0. Floor.
- 32—33. Fragments of a bronze tweezer with widening arms. Length 6.1. Floor.
34. White Painted II jug as No. 8; decorated as No. 6. Damaged. Floor.
35. White Painted III shallow bowl with round base and a horizontal handle at rim. Hatched triangles around rim; crossed, wavy lines and dots on base; transverse lines on handle; concentric, wavy lines and crossed straight lines inside. Diam. 11.0. Floor.
36. Bronze knife as No. 16. Length 17.2. Floor.
37. Leaf-shaped bronze knife with two edges, rounded end; flat, tapering tang, low midrib, and three rivet-holes through tang. Length 13.5. Floor.
38. Bronze axe as No. 4, but with a hole through top. Length 15.2. Floor.
39. Fragments of a White Painted II jug as No. 6. Floor.
40. Triangular bronze sword with straight sides, pointed end, high midrib, two edges, two deep cuttings near the tang, and hooked, solid tang. Length 56.3. Floor.
41. Bronze axe as No. 4. Length 12.0. Floor.
42. Bronze chisel with flat widening end, square section, and a large horn-handle. Length 26.3. Floor.
43. Bronze knife as No. 16, but with two rivet-holes through top. Length 12.2. Floor.
44. Red Polished III hemispherical bowl with a string-hole projection at rim. Rim chipped. Diam. 16.5. Floor.
45. White Painted III globular jug with round base, concave neck, slightly splaying rim, oblique mouth, and a knobbed handle from rim to shoulder. Straight and wavy lines around neck; broad lattice-bands and wavy lines from neck to base, an encircled dot on base, and a framed, wavy line on handle. Height 14.4. Floor.
46. Red Polished III jug as No. 6. Rim missing. Height 14.0. Floor.
47. Bronze dagger as No. 3. Length 37.5. Floor.
48. Red Polished III hemispherical bowl with a knobbed, horizontal handle at rim. Incised lines on handle. Diam. 18.2. — 34.
49. White Painted III bowl as No. 35. Parallel, oblique lines around rim; straight and wavy lines on base, wavy lines inside, and transverse lines on handle. Diam. 11.7. — 34.

D r o m o s C u p b o a r d

1. White Painted II pear-shaped jug with round base, tapering neck, splaying rim; pinched, oblique mouth, handle from rim to shoulder, and a projection opposite the handle. Straight and wavy lines around neck;

broad lattice-bands and wavy lines from neck to base; an encircled dot at base, and transverse lines on rim and handle. Height 16.7.

2. White Painted III deep bowl with round base, slightly splaying rim, and a high handle from rim to body. A

frieze of oblique lines around body. Paint worn. Handle broken. Height 7.1.

3. White Painted III shallow bowl with round base, and a knobbed horizontal handle at rim. Decoration obliterated. Damaged. Diam. 9.3.

Summing up the Object Register and the stratigraphical observations we obtain the following diagram:

	Pottery										Bronze						Stone	Terracotta				
	R. P. II	R. P. III	R. P. IV	Wh. P. II	Wh. P. III	Bl. P.	Bl. Sl. I	Coarse	Pins	Needles	Knives	Daggers	Sword	Spatula	Chisel	Tweezers	Axes	Loom-weight	Whetstone	Spindle-whirls	Idol	
Chamber A	34, 48	5. 8	7. 23	3. 10	2. 4	I	54	50	42	42	32	79		56		41	65	60	33	17	38	
	68, 72	9. 13	35. 73	12. 14	6. 18	II		53	55	57	64	87				47				49.	63	
	76	15. 16	75. 93	26. 29	20. 22	45			55	83	80					82				69.	69	
		19. 21		30. 37	24. 28				57		84										71.	71
		25. 27		43. 46	31. 37				81		89											
		36. 39		74. 77	58. 67																	
		40. 44		86. 92	70. 85																	
		51. 52			90. 91																	
		59. 61			94. 95																	
		62. 66			97																	
	78. 88																					
	96																					
	-5	-23	-6	-14	-19	-3	-1	-2	-5	-3	-5	-2		-1		-3	-1	-1	-1		-8	
Chamber B—C 1st group		1. 2	48	34. 39	25. 26	29					19	47	40	Awls	42	32	38				28	
		22. 23			27. 31						36			20. 21		33	41					
		24. 30			35. 45						37											
		39. 44			49						43											
	46																					
	-9	-1	-2	-7	-1					-4	-1	-1	-2	-1	-2	-2					-1	
Chamber B—C 2nd group		7. 8		6. 18	5				12.	11	16	3		15		9	4			14		
		17							13							10						
	-3			-2	-1				-2	-1	-1	-1		-1		-2	-1				-1	
Dromos cupboard				I	2. 3																	
				-I	-2																	

CHRONOLOGY

To judge by the large amount of Red Polished Ware in Chamber A, this chamber seems to contain the earliest burials, but it was certainly afterwards used simultaneously with the other chambers. Its lack of stratigraphical evidence, and the difficulties of the excavation, make it impossible to split it up into different groups, but the presence of Black Slip Ware and the considerable numbers of White Painted III Ware give reasons for presuming that there must have been at least one later period of burials.

The two groups from the other chamber give the impression of being roughly simultaneous. Probably the tomb was cut in the beginning of M. C. I and used till the beginning of M. C. II.

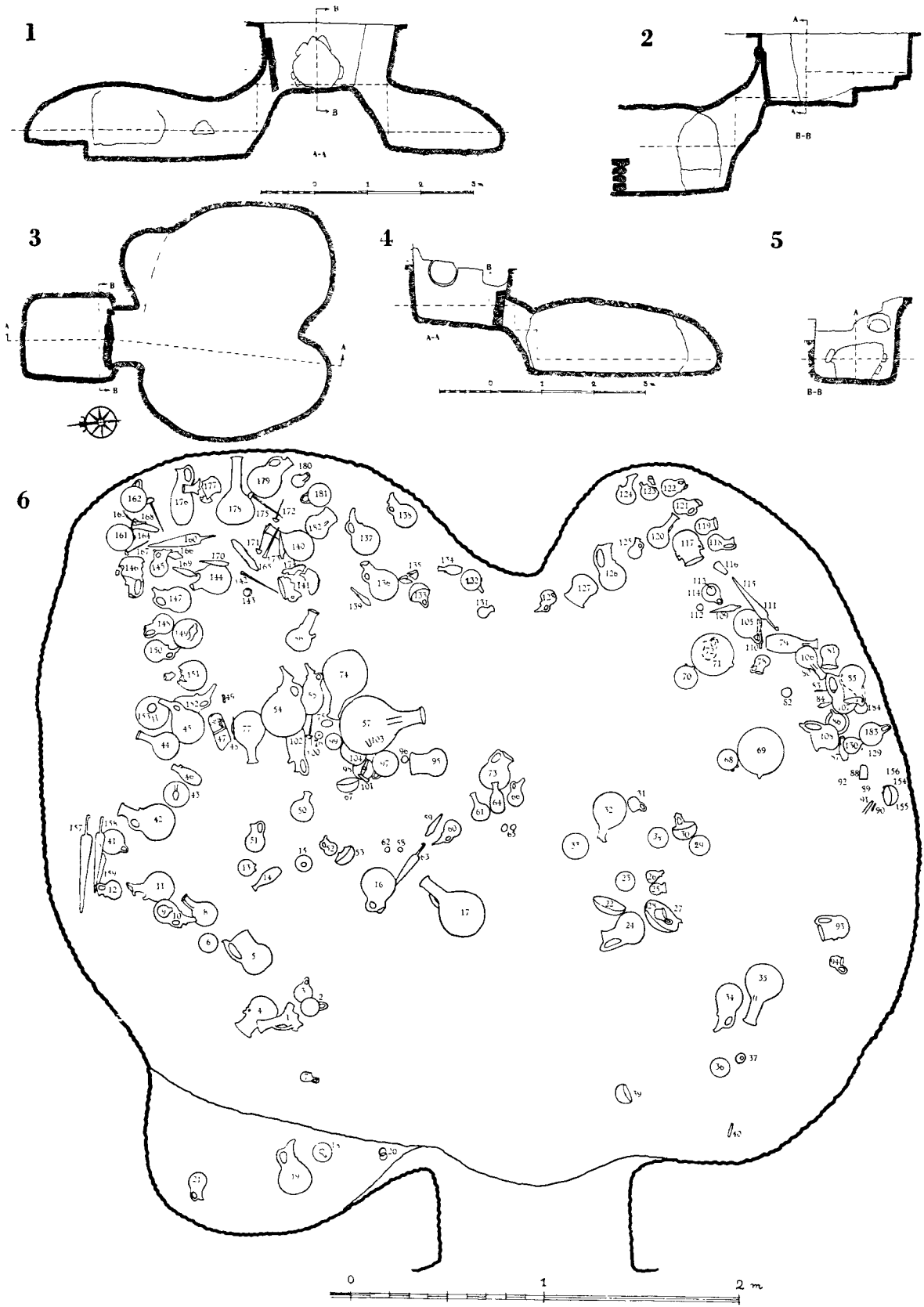

Fig. 46. Lapithos. Tomb 315, Sections A-A, B-B (1, 2). Tomb 316, Plan (3); Sections A-A, B-B (4, 5); Finds *in situ* (6).

TOMB 316 (Figs 46: 3—6; 47)

	SIZE			
	Length	Width	Depth	Height
Dromos	1.84	1.55	1.60	—
Stomion	0.46	1.01	—	0.50
Chamber	3.14	4.42	—	1.28

SHAPE

The plan of the dromos is almost square with rounded corners. Its N. E. side is damaged by modern stone cutters, but the original depth is traceable on the opposite side. Thus, the dromos can be reconstructed as an almost cubic shaft.

Only one chamber opens on to the dromos. It was closed by a flat block of stone, wedged by four smaller stones. The stomion is a short, wide tunnel, sloping steeply down to the level of the chamber floor. The chamber is heart-shaped with a central projection in the back wall, and a shallow niche to the left of the entrance. The floor is horizontal, and roof and walls gently curved so as to form a low vault. Six small cupboards, three of which were plundered, were found along the edge of the dromos, two on each long side and one at each short end.

STRATIFICATION

The dromos was filled with a loose mass of *chavara* mixed with potsherds of the Red Polished III, White Painted II and III, and Black Slip Wares. The consistency of the filling matter and the shape of the dromos, seem to prove that the dromos had been entirely emptied every time the chamber was used for burials. The dromos cupboards have, presumably, been cut subsequently in connection with the different burials.

The finds and the skeletal remains were all found directly on the floor, or raised a few centimetres above it. In the latter case, they have been moved by water pouring in through the stomion and traceable as a thin layer of silted clay found here and there on the floor. The find stratum was covered by a layer, about 0.40 m. thick, of white *chavara* debris fallen from roof and walls. There has been no severe collapse of the roof and the rock had crumbled slowly, to judge from the good state of the pottery. The moisture of the earth had, however, affected the bronzes badly.

Six burials were found in the chamber (cf. the corresponding number of cupboards in the dromos), four of them around the walls and two in the central area. The latter may be of slightly later date, and the tomb-gifts attributed to this group, as follows: — Nos. 13—17, 22—33, 47—67, 74, 75 and 95—104. The rest of the finds should belong to the earlier group of four skeletons along the walls. The lack of stratification among the finds is an indication that the difference in time between the two groups cannot be very great; but it must also be borne in mind, that by the division of the finds into two groups, nothing else is suggested, than that the tomb-gifts belonging to the second group are later than the rest of the contents. The difference in date between the last burial of the first group, and



Fig. 47. Lapithos. Tomb 316, dromos.



Fig. 48. Lapithos. Tomb 318, dromos.

the first burial of the second group cannot have been very long, but a longer space of time may have elapsed between some of the burials in the respective groups. The evidence, however, is not sufficient for an exact relative chronology.

BURIALS

The preservation of the skeletal material was very bad, and the original positions of the corpses could not be seen.

FINDS (GROUPS: PLS. XXXI, XXXII, I; TYPES: L. OF PL. II)

1. Red Polished III globular jug with round base, cylindrical neck; small, flat rim, and handle from neck to shoulder. Incised lines on handle. Not complete. Floor.
2. White Painted III shallow bowl with round base and a horizontal handle at rim. Parallel, oblique lines around rim, crossed lines on base, and concentric, wavy lines inside; a wavy line on handle. Diam. 8.9. Floor.
3. White Painted III bowl as No. 2. Rim chipped. Diam. 9.5. Floor.
4. White Painted III globular amphora with flattened base, wide, cylindrical neck, flat rim, and two profiled handles with string-holes from neck to shoulder. Parallel, oblique lines on rim; bands of wavy lines, and of filled and latticed triangles around neck and body; crossed lines on base; four vertical, wavy lines from rim to shoulder. Paint partly worn. Height 20.9. Floor.
5. Black Slip II globular jug with flat base; wide, cylindrical neck, splaying rim, and a knobbed handle from rim to shoulder. Height 24.5. Floor.
6. White Painted III squat amphora with round base; wide, concave neck, and two angular handles from neck to shoulder; crossed lines on the base; rest of decoration obliterated. Height 8.6. Floor.
7. Red Polished III globular miniature jug with round base, small rim, and a high handle from rim to body. Paint obliterated. Height 8.7. Floor.
8. Black Slip II pear-shaped jug with round base, concave neck, slightly pinched mouth, and handle from rim to shoulder. Height 20.6. Floor.
9. Red Polished III globular miniature jug with flattened base; small, concave neck, and a string-hole handle from neck to shoulder. Paint worn. Height 7.2. Found on No. 10.
10. Red Polished III oval jug with round base, cylindrical neck, beaked mouth, a knobbed handle from neck to shoulder, and a string-hole projection opposite the handle. Height 22.3. Floor.
11. Red Polished III jug as No. 10, but with a plain

- handle from rim to shoulder. Rim chipped. Height 24.1. Floor.
12. White Painted II jug with round base, conical shoulder, cylindrical neck, splaying rim, a handle from rim to shoulder, and string-hole projections on and opposite the handle. Encircling lines around neck; broad lattice-bands and wavy lines from neck to belly; wavy lines around belly, and an encircled wheel on base. Transverse lines on handle. Paint worn. Height 13.4. Floor.
 13. White Painted III bowl as No. 2. Handle missing. Diam. 7.8. Floor.
 14. White Painted III flat, oblong bottle, with flat base; narrow, tapering neck, wide rim, and a small handle from neck to body. Horizontal lines around neck, and vertical bands of hatched lozenges and wavy lines on body. Paint much worn. Height 16.0. Floor.
 15. White Painted III pear-shaped jug with round base; narrow, cylindrical neck, splaying rim, and a high handle from rim to shoulder. Handle missing. Decoration as No. 12. Height 14.7. Floor.
 16. Red Polished III pear-shaped jug with round base, cylindrical neck, beaked mouth and handle from rim to shoulder. Rim missing; paint worn. Height 20.6. Floor.
 17. Black Slip I pear-shaped jug, with round base, cylindrical neck, stilted rim, handle from neck to shoulder, and a small string-hole projection opposite the handle. An incised wavy line on handle. Paint worn. Height 38.2. Floor.
 18. White Painted III pear-shaped jug, with flattened base; narrow, cylindrical neck; open, round mouth; tubular spout; an angular handle from neck to shoulder, and string-hole projections on neck and handle. Decoration much worn. Spout missing. Height 14.0. Floor.
 19. Red Polished III jug as No. 10, but with plain handle. Height 29.9. Floor.
 20. Two circular bronze rings with overlapping ends. Diam. 3.7. Floor.
 21. White Painted III pear-shaped jug with round base, tapering neck, beaked mouth, and handle from rim to shoulder. Encircling lines around the neck; crossed bands of parallel lines on the sides; broad, framed lattice-bands below the handles and as front ornament; concentric, wavy lines on base. Rim chipped. Height 14.9. Floor.
 22. Black Slip II shallow bowl with round base, and an angular string-hole handle at rim. Incised, framed zigzag bands around body and on base. Diam. 17.0. Floor.
 23. White Painted III bowl as No. 2. Handle missing. Diam. 10.4. Floor.
 24. Red Polished IV globular jug with round base; tall, tapering neck, splaying rim; pinched, oblique mouth, and a high, angular handle from rim to shoulder. Height 26.5. Floor.
 25. White Painted III squat, globular jug, with round base; wide, cylindrical neck, flat rim, and handle from rim to shoulder. Framed bands of hatched lozenges and zigzag lines around rim, neck and body; straight and wavy crossed lines on base. Handle missing. Height 10.0. Floor.
 26. Black Slip II conical bottle, with round base; narrow, cylindrical neck, slightly splaying rim, and a string-hole handle from neck to shoulder. Height 8.7. Floor.
 27. Red Polished IV deep bowl, with round base, and a high handle from rim to body. Height 7.7. Floor.
 28. Black Slip II shallow bowl, with round base, a string-hole handle at the rim and a semicircular spout opposite the handle. Diam 22.0. Floor.
 29. Black Polished hemispherical bowl, with round base, a horizontal string-hole handle below rim, and a cavity in the centre of the base. Rim chipped. Diam. 10.0. Floor.
 30. Black Slip II shallow bowl, with round base, in-turned rim, and a high handle, pierced by three string-holes on rim. Diam. 11.2. Floor.
 31. Red Polished IV bowl as No. 27. Height 7.3. Floor.
 32. Red Polished III oval jug with round base, cylindrical neck, splaying rim, and handle from neck to shoulder. Rim chipped. Height 25.1. Floor.
 33. White Painted II bowl as No. 2. Hatched triangles around rim; straight and wavy lines, meeting in a chess-board pattern on base; concentric, wavy lines and straight, crossed lines inside. Handle missing. Diam. 11.6. Floor.
 34. White Painted II jug as No. 19. Encircling lines around neck; broad lattice-bands and wavy lines from neck to base, and concentric circles on base. Height 27.2. Floor.
 35. White Painted III globular jug with round base; tall, tapering neck; wide, stilted rim, a handle from neck to shoulder, and a profiled string-hole projection opposite the handle. Encircling lines around neck; vertical, broad bands of crossed lines on the sides; broad lattice-bands below handle and as front ornament; framed, wavy lines around belly and base; crossed lines on base; oblique lines on rim, and two wavy lines around shoulder. Height 30.2. Floor.
 36. White Painted III bowl as No. 2. Handle missing. Diam. 9.3. Floor.
 37. White Painted III globular miniature jug, with round base; tapering, convex neck, slightly splaying rim, a high handle from rim to shoulder, and two string-holes below rim. Decorated as No. 15. Piece of base missing. Paint worn. Height 7.2. Floor.
 38. White Painted III bowl as No. 2. Handle missing. Diam. 10.7. Floor.
 39. White Painted II bowl as No. 33. Handle missing. Diam. 10.0. Floor.
 40. Oblong whetstone pierced by a hole at top. Length 6.1. Floor.
 41. White Painted III bowl as No. 2. Hatched triangles around rim; a wavy line inside rim; straight and wavy lines meeting in a cross outside and inside; transverse lines on handle. Diam. 11.8. Floor.
 42. Red Polished III pear-shaped jug with round base; tall, cylindrical neck, stilted rim, a handle from neck

- to shoulder, and a string-hole projection opposite the handle. Incised lines on handle. Height 29.5. Floor.
43. Black Slip II jug as No. 19, but with handle from neck to shoulder. Incised lines on handle, a zigzag band around neck, and two vertical lines from front of mouth to shoulder. Height 20.3. Floor.
 44. Red Polished III jug as No. 42, but with a knob on handle. Height 23.2. Floor.
 45. Red Polished III jug as No. 43. Incised lines on the handle. Height 28.0. Floor.
 46. White Painted III bottle as No. 14. Paint obliterated. Height 16.2. Floor.
 47. Red Polished plank-shaped idol. It seems to suggest an imitation of a cradle with a small child, but is too badly preserved, to allow of an interpretation in details. Length 19.5. Floor.
 48. Straight bronze needle with a flattened head pierced by an eyelet. Broken. Length 12.0. Floor.
 49. Bronze tweezer with rounded top. Length 6.6. Floor.
 50. Red Polished IV globular jug with round base; short, tapering neck, splaying rim, and a knobbed handle from neck to shoulder. Height 15.1. Floor.
 51. Red Polished IV pear-shaped jug with round base, cylindrical neck, splaying rim, oblique mouth, and handle from neck to shoulder. Incised lines on neck and handle. Height 15.7. Floor.
 52. Red Polished III oval jug with round base, conical neck, beaked mouth, and handle from rim to shoulder. Paint worn. Height 11.3. Floor.
 53. White Painted III bowl as No. 2. Wavy lines around rim; straight and wavy lines meeting in a cross outside and inside. Handle missing. Diam. 11.6. Floor.
 54. White Painted II jug as No. 43. Straight and wavy lines around neck; broad lattice-bands from neck to base; framed, wavy lines around base; concentric circles on base; a framed, wavy line from top of mouth to neck, and encircled dots on belly. Height 36.0. Floor.
 55. White Painted III oblong jug with flat base; short, concave neck, beaked mouth, a handle from neck to shoulder, and three string-hole projections on neck. Wavy lines on neck, broad lattice-bands and chess-board patterns from neck to belly, and encircling, framed, wavy lines around base. Height 25.5. Floor.
 56. Red Polished IV globular jug with round base; tall, tapering neck, stilted rim; oblique, pinched mouth, a high handle from rim to shoulder, and a projection opposite the handle. Handle missing. Height 23.2. Floor.
 57. Red Polished III globular jug with round base, tapering neck, splaying rim, and handle from neck to shoulder. Incised zigzag lines on neck and handle. Surface partly worn. Height 45.7. Floor.
 58. Two circular bronze rings with overlapping ends. Broken. Diam. 2.6; 2.7. Floor.
 59. Leaf-shaped bronze knife with concave sides, pointed end, low midrib; flat, tapering tang, and three rivet-holes. Length 13.9. Floor.
 60. White Painted III jug as No. 18. Encircling lines around spout and neck, broad lattice-bands from neck to base, and concentric circles on base. Height 15.9. Floor.
 61. Red Polished III globular jug, with tall, cylindrical neck, splaying rim, handle from rim to shoulder, and a small projection on belly opposite the handle. Bands of vertical and zigzag lines, and of hatched lozenges around neck and body; transverse lines on rim. Handle missing. Height 14.6. Floor.
 62. Spiral-shaped bronze ring. Diam. 3.2. Floor.
 63. Bronze dagger with straight sides, pointed end, two edges, high midrib, rounded top, two deep cuttings near the tang, and a hooked, solid tang. Tang bent; edge damaged. Length 33.0. Floor.
 64. White Painted III oblong bottle with flat base, cylindrical neck, splaying rim, and a small handle from neck to shoulder. Encircling lines around neck; framed bands of lattice-triangles, filled triangles, zigzag lines and wavy lines around body, and two vertical, framed, wavy lines on the sides; transverse lines on rim. Height 15.9. Floor.
 65. Black Slip globular spindle-whirl with crossed, incised lines on the sides. Diam. 4.2.
Black slip spindle-whirl as the above described. Diam. 2.8. Floor.
 66. Red Polished III pear-shaped jug with round base, cylindrical neck, beaked mouth, and handle from rim to shoulder. Height 14.2. Floor.
 67. Red Polished III shallow bowl with a horizontal handle at rim. Handle missing. Diam. 11.3. Floor.
 68. White Painted III bowl as No. 2. Parallel, oblique lines around rim; a band of parallel zigzag lines on base, and wavy lines from rim to base; concentric wavy lines inside. Handle missing. Diam. 11.0. Floor.
 69. Red Polished III wide, shallow bowl with round base, and an angular string-hole projection at rim. Diam. 26.3. Floor.
 70. White Painted III bowl as No. 2; decorated as No. 41. Handle missing. Diam. 10.7. Floor.
 71. Red Polished IV almost hemispherical, wide bowl with round base, and a string-hole handle at rim. Diam. 20.4. Floor.
 72. Red Polished globular jug with wide, convex neck, pinched mouth, handle from rim to shoulder, and a small projection opposite the handle. Parallel, wavy lines around neck and body, and vertical lines on handle. Paint worn. Height 9.3. Floor.
 73. Red Polished IV pear-shaped jug, with round base, concave neck, pinched mouth, and a knobbed handle from rim to shoulder. Height 20.7. Floor.
 74. Black Slip II jug as No. 57. Incised lines on handle. Paint worn. Height 34.8. Floor.
 75. White Painted III bottle as No. 14. Vertical, straight and wavy lines from neck to base; rim and pieces of neck missing. Height 10.4. Floor.

76. Red Polished squat, conical spindle-whirl with flat ends, and incised lines on the sides. Diam. 5.1. Floor.
77. Black Slip II jug as No. 57. Height 26.2. Floor.
78. White Painted III globular jug, with round base, concave neck, and handle from rim to shoulder. Encircling lines around neck, network bands from neck to belly; crossed, wavy lines around lower part of body and base. Height 9.8. Floor.
79. White Painted III bottle as No. 14. Horizontal bands of straight lines, hatched lozenges, and zigzag lines around neck and body; wavy lines on rim, and parallel, oblique lines on handle. Paint partly worn. Height 26.4. Floor.
80. Three bronze needles with flattened heads, pierced by eyelets. Length 6.1; 6.1; 4.0. Floor.
81. White Painted III amphora as No. 4. Neck, body, and base are covered with square and oblong chess-board patterns; filled triangles on rim; vertical, framed, wavy lines above and below the handles. Height 14.4. Floor.
82. Fragments of a Red Polished III bowl as No. 7. Floor.
83. Bronze pin with plain head, and an eyelet through the middle of the pin. Length 11.7. Floor.
84. Leaf-shaped bronze knife with rounded end, straight sides; flat, narrow tang, low midrib, two edges, and three rivet-holes through tang. Length 8.5. Floor.
85. White Painted III globular jug with flat base; wide, slightly concave neck, stilted rim, handle from rim to shoulder, and an angular string-hole projection opposite the handle. A wavy line on rim, chess-board patterns on neck and body; a framed, wavy line from rim to string-hole; parallel, oblique lines from string-hole to base and below handle; a wavy line around base, crossed lines on base, and a wavy line on handle. Height 18.8. Floor.
86. Red Polished III globular cooking-pot with round base; short, wide neck, a high handle from rim to shoulder, and a projection opposite the handle. Height 13.6. Floor.
87. Black Slip II oblong bottle, with flat base, cylindrical neck, and two small handles from neck to shoulders. Paint worn. Height 11.3. Floor.
88. Oblong whetstone, pierced by a hole at top. Length 8.8. Floor.
89. Four circular bronze rings with overlapping ends. Diam. 3.4; 3.2; 3.3; 2.8. Floor.
90. Bronze needle as No. 80. Length 6.1. Floor.
91. Bronze tweezer with rounded top. Broken. Length 8.5. Floor.
92. Two small circular bronze rings with overlapping ends. Diam. 2.0; 1.7. Floor.
93. White Painted III jug as No. 85, but with knobbed handle, and profiled projection. Height 17.5. Floor.
94. Red Polished III bowl as No. 27. Height 10.3. Floor.
95. White Painted III jug as No. 93, but with round base, and herring-bone pattern between neck and shoulder, and as front ornament; concentric circles and wavy lines on base. Height 20.9. Floor.
96. Red Polished spindle-whirl as No. 65. Diam. 3.5. Floor.
97. White Painted III bowl as No. 2; decorated as No. 68. Diam. 11.6. Floor.
98. Red Polished III globular jug with tall, thin neck, beaked mouth, handle from rim to shoulder, and two projections on neck. Horizontal lines around neck, vertical zigzag lines from neck to base, and hatchings on handle. Paint worn. Height 18.4. Floor.
99. Fragments of a Red Polished III miniature jug. Floor.
100. Thick bronze pin with large "mushroom-head" and an eyelet through the middle of the pin. Broken. Length. c. 20.0. Floor.
101. Leaf-shaped bronze knife with convex sides, pointed end, two edges, low midrib; flat, tapering tang, and two rivet-holes through tang. Broken. Length 14.1. Floor.
102. White Painted III flat, oblong bottle with flat base, tapering neck, splaying rim, a high handle from rim to shoulder, and a string-hole projection opposite the handle. Straight and wavy lines around neck, bands of hatched lozenges and zigzag lines around body, and crossed lines on base. Height 26.0. Floor.
103. Fragments of a bronze tweezer; much corroded. Floor.
104. White Painted III amphora, as No. 4, but with angular handles from neck to shoulder. Bands of hatched lozenges around neck and body, wavy lines on rim and base, and crossed, wavy lines on base. Paint partly worn. Height 17.5. Floor.
105. Black Slip II shallow bowl with round base, slightly inwards-turned rim, and a horizontal handle at rim. Diam. 14.3. Floor.
106. White Painted III jug as No. 35, but without projection. Encircling lines around neck, bands of filled and latticed triangles on the sides; broad lattice-bands below handle and as front ornament; a band of latticed, irregular triangles around base, and concentric circles and wavy lines on base. Paint partly worn. Height 18.3. Floor.
107. White Painted III jug as No. 24. Decorated as No. 34. Height 22.5. Floor.
108. Black Slip II squat jug with rounded base; wide, cylindrical neck, flat rim, a high, knobbed handle from rim to shoulder, and a projection opposite the handle. Straight and wavy lines in low relief around rim, neck, and body. Height 16.4. Floor.
109. Leaf-shaped bronze knife with two edges, concave sides, pointed end, low midrib, and flat, rounded tang with three rivet-holes. Length 16.5. Floor.
110. Bronze knife as No. 109, but with narrow, flat tang, and one rivet-hole. Length 13.9. Floor.
111. Bronze dagger as No. 63. Length 36.2. Floor.
112. Bronze spiral. Diam. 3.0. Circular bronze ring with overlapping ends. Diam. 2.2. Floor.
113. Oval mace-head of stone with a cylindrical hole through the centre. Diam. 5.3. Found in No. 114.
114. White Painted II bowl as No. 2. Parallel, oblique lines around rim, crossed lines on base, four encircled dots in their interstices, a wavy line inside rim, and crossed straight and wavy lines inside. Diam. 9.4. Floor.

115. Bronze awl with square section and tapering tang. Length 8.1. Floor.
116. Bronze axe with widening sides, curved edge, and a profiled back. Length 7.9. Floor.
117. White Painted III amphora as No. 104. Straight and wavy lines around neck and base; bands of lattice-lozenges around body; parallel, oblique lines on rim; vertical, wavy lines below the handles, and a dot on base. Height 16.0. Floor.
118. White Painted III jug as No. 8; decorated as No. 60. Height 14.4. Floor.
119. White Painted III jug as No. 93. Straight and wavy lines around neck and belly; a band of parallel, oblique lines around shoulders, and crossed lines on base. Height 12.8. Floor.
120. White Painted III jug as No. 35, but with knobbed handle; decorated as No. 34. Height 21.0. Floor.
121. Red Polished IV globular jug, with flat base, cylindrical neck, and handle from neck to shoulder. Rim missing; very clumsy shape; paint obliterated. Height 13.5. Floor.
122. White Painted II jug as No. 34. Rim chipped. Height 13.6. Floor.
123. Fragments of a Black Polished incised jug. Floor.
124. Red Polished III jug as No. 66. Handle missing. Height 16.7. Floor.
125. Black Slip II oval jug with round base; narrow, cylindrical neck; small, flat rim, and handle from neck to shoulder. Paint much worn. Height 10.7. Floor.
126. White Painted II jug as No. 8, but with a projection opposite the handle; decorated as No. 34. Height 24.0. Floor.
127. White Painted III amphora as No. 104. Crossed, vertical and horizontal lines on neck and body; crossed bands and wavy lines on base, and transverse lines on rim. Height 14.2. Floor.
128. Red Polished III jug as No. 19. Height 13.9. Floor.
129. Fragments of a Black Slip II bowl. Floor.
130. White Painted II jug as No. 34. Pieces of neck and rim missing. Height 9.9. Floor.
131. Red Polished III globular jug with round base; short, tapering neck, splaying rim, and a small, angular handle from neck to shoulder. Height 8.8. Floor.
132. White Painted III deep, conical bowl, with flattened base, and handle from rim to body. Encircling, straight and wavy lines around rim and base; a band of hatched triangles below rim, and vertical, wavy lines inside. Paint worn. Diam. 10.2. Floor.
133. White Painted III bowl as No. 2. Diam. 9.5. Floor.
134. White Painted III bottle as No. 14. Height 12.5. Floor.
135. Fragments of a White Painted III bowl as No. 2. Floor.
136. Red Polished III jug as No. 57. Rim chipped; paint worn. Height 23.9. Floor.
137. Black Slip II jug as No. 19. Handle missing. Height 25.6. Floor.
138. Black Slip II jug as No. 43, but without projection. Height 19.8. Floor.
139. Leaf-shaped bronze knife, with concave sides, two edges, low midrib, pointed end, and long, rounded top with three rivet-holes. Length 12.6. Floor.
140. Red Polished III jug as No. 57. Hatchings on handle. Height 26.2. Floor.
141. Fragments of a Red Polished III globular cooking-pot. Floor.
142. Bronze pin with flattened head, and an eyelet below the head. Length 21.8. Floor.
143. Bronze ring with overlapping ends. Diam. 4.3. Floor.
144. White Painted II jug as No. 19; decorated as No. 34. Paint worn. Height 25.7. Floor.
145. Red Polished III jug as No. 138. Height 15.0. Floor.
146. Fragments of a White Painted II jug; similar to No. 26. Floor.
147. Red Polished III jug as No. 10. Height 21.0. Floor.
148. Black Slip II jug as No. 56. An incised line around neck, and a vertical zigzag line from front of rim to shoulder. Rim chipped. Height 15.1. Floor.
149. Black Slip II jug as No. 19. Height 24.3. Floor.
150. White Painted II jug as No. 43; decorated as No. 34. Height 19.0. Floor.
151. Fragments of a Red Polished III jug. Floor.
152. White Painted II jug as No. 34. Height 26.4. Floor.
153. Red Polished III jug as No. 19. Rim chipped. Height 21.2. Floor.
154. White Painted III bowl as No. 2, and decorated as No. 41. Handle missing. Diam. 10.3. Floor.
155. Straight bronze needle with flattened head pierced by an eyelet. Head not complete. Length 10.3. Floor.
156. Fragment of a Red Polished III bottle. Floor.
157. Bronze sword with straight sides, two edges, pointed end, high midrib, rounded top, deep cuttings near the tang, and a hooked, solid tang. Edge partly chipped. Length 50.4. Floor.
158. Bronze sword as No. 157. Length 39.4. Floor.
159. Leaf-shaped bronze knife with rounded end, straight sides, low midrib; flat, tapering top, and three rivet-holes through top. Length 14.2. Floor.
160. Bronze dagger as No. 157, but without cuttings near the tang. Length 34.2. Floor.
161. White Painted III bowl as No. 2. Straight and wavy lines around rim, and crossed lines outside and inside. Handle missing. Paint worn. Diam. 13.9. Floor.
162. White Painted III bowl as No. 2; decorated as No. 41. Diam. 12.5. Floor.
163. Bronze axe with widening sides, and broad, curved edge. Length 14.3. Floor.
164. Bronze tweezer with rounded top. Length 8.8. Floor.
165. Bronze scraper with two edges, concave sides, and two tapering tops without edges. Probably used with two handles for splitting wood. Length 19.7. Floor.
166. Bronze knife as No. 159, but with concave sides. Length 15.3. Floor.
167. Bronze pin with "mushroom head" and an eyelet through the middle of the pin. Broken. Length 14.2. Floor.
168. Bronze pin as No. 167. Length 18.6. Floor.

169. Broad, triangular bronze knife with rounded end and narrow tang. Broken. Length 13.6. Floor.
170. Bronze knife as No. 166. Length 15.3. Floor.
171. Bronze pin as No. 167. Length 14.5. Floor.
172. Bronze pin as No. 167. Length 11.7. Floor.
173. Bronze pin with thickening head and an eyelet through the middle of the pin. Length 16.8. Floor.
174. Bronze knife as No. 166. Length 14.3. Floor.
175. Bronze pin as No. 167. Badly corroded. Length 20.6. Floor.
176. White Painted III bottle as No. 102, but without projection. Bands of filled and hatched lozenges and of chess-board patterns around neck and body; crossed lines on base, and parallel, oblique lines on handle; vertical bands of crossed zigzag lines below and opposite the handle. Height 28.7. Floor.
177. Fragments of a Black Slip II jug. Floor.
178. White Painted III globular jug with round base; tall, cylindrical neck; wide, flattened rim, handle from base of neck to shoulder, and six projections on neck. Decoration obliterated. Height 35.4. Floor.
179. Red Polished III pear-shaped jug with round base, cylindrical neck, splaying rim, a knobbed handle from neck to shoulder and a small projection opposite the handle. Horizontal ridges around neck and shoulder. Height 24.5. Floor.
180. Red Polished III pear-shaped jug with round base, concave neck, splaying rim, and handle from rim to shoulder. Height 10.4. Floor.
181. White Painted III bowl as No. 2; decorated as No. 41. Paint worn. Diam. 12.0. Floor.
182. White Painted III amphora as No. 104. Chess-board patterns around neck and body; parallel, oblique lines

- on rim and handles; concentric, wavy lines, and crossed, straight lines on base. Height 15.7. Floor.
182. White Painted III bowl as No. 2. Diam. 10.8. Floor.
184. Red Polished III jug as No. 125. Height 10.0. Floor.

Dromos cupboard 1

1. Red Polished III pear-shaped jug with round base. Not complete. Height 12.2.
2. White Painted III shallow bowl with inwards-turned rim, and a horizontal handle below rim. A wavy line inside rim; a band of parallel, oblique lines around rim, crossed lines outside and inside, and transverse lines on handle. Diam. 8.6.

Dromos cupboard 2

1. White Painted III shallow bowl, with inwards-turned rim, and a horizontal handle below rim. A wavy line inside rim; a band of parallel, oblique lines around rim, crossed bands of parallel lines on base; crossed lines inside, and transverse lines on handle; short, wavy lines as filling ornaments. Handle missing. Diam. 11.0.
2. White Painted III oblong, flat bottle with flat base, tapering neck, splaying rim, and a small handle from neck to body. Encircling lines around neck; chess-board pattern on body, bands of wavy lines on the sides and around base, concentric circles on base, and transverse lines on rim. Height 13.9.
3. Six circular rings of silver-lead with overlapping ends. Diam. 2.2; 2.1, 1.9, 1.8, 1.8, 1.5.

Dromos cupboard 3

1. Fragments of several rings of silver-lead.
2. Five potsherds of White Painted III Ware.

CHRONOLOGY

The statistical survey shows a certain inconsistency in the groups. The first group contains a remarkable amount of White Painted III Ware, which is surprising, considering its presumed earlier date. However, from the position of the finds, we can state that fourteen of the thirty-eight White Painted III and all the Red Polished IV pots* belonging to the first group, are concentrated together with some other tomb-gifts round the skeleton to the right of the central projection in the back wall. This is a reason to suppose that this burial has chronologically, to be assigned to the second group; a fact which could not be inferred merely from the actual position of the remains in the chamber.

The tomb must be dated to the Middle Cypriote II period.

*Nos. 68, 70, 71, 72, 78, 81, 85, 106, 107, 117, 118, 119, 120, 121, 127, 154, and 173.

SHAPE

The dromos is an oblong shaft with rounded corners, and walls widening upwards. The floor slopes towards the entrance of the single chamber, and about 0.80 m. from the back wall is a step of a depth of 0.30 m.

The stomion is blocked by a thin slab of local limestone, wedged in by some chips of the same material, and slopes irregularly down to the level of the chamber.

The chamber is roughly round, and provided with two semicircular niches. The eastern one of these is elevated 0.18 m. above the main floor-level. The floor is almost horizontal and the roof which is fairly well preserved forms a low vault. Along the eastern part of the back wall, and at a distance of about 0.50 m. from it, is a row of flat stones laid on the floor.

STRATIFICATION

The dromos-filling consisted, except for a thin bottom layer of sterile rock debris, of two main layers. The lower one of these was hard packed, and contained very few sherds. It started from the step in the dromos and sloped gradually down towards the entrance of the chamber. The upper layer was of looser consistency, and filled the dromos to the edge. Both layers consisted of broken *chavara*, but the upper one contained more potsherds, principally of Red Polished II and III Ware. The stratification proves that the dromos has been partly cleared out in connection with a second burial. The lower layer was the remains of the original filling.

The floor of the chamber was covered by a thin layer of finely silted clay produced by the winter rains. The burial gifts were found on the floor or in this layer. The levels of the finds, that have been slightly elevated by the entrance of the water, have, therefore, no chronological significance. The layer containing the finds was covered by a stratum of *chavara* fallen from the roof. The debris had, however, caused no serious damage to the finds.

In the eastern niche and at the area enclosed by the flat stones at the back wall, were tiny remains of burial layers, consisting of the usual dark-brown earth. Which of the two burials was the earlier could not be proved, and they do not seem to have been separated by any great length of time.

BURIALS

The state of preservation of the skeletons was very bad. Of the burial in the niche there was practically nothing left, and within the stone setting there were found only a few fragments of the tibiae. Immediately outside the westernmost stone lay two pieces of a skull. These few remains give no safe base for conclusions as regards the burial customs, but it may be pointed out that neither the niche nor the area inside the stones were large enough to allow of an outstretched position of the bodies.

FINDS (GROUPS: PL. XXXII, 2, 4)

1. Fragments of a Red Polished II incised jug. Floor.
2. Red Polished II oval amphora with round base, cylindrical neck, splaying rim, and two angular handles from neck to shoulder. Button-ornaments on neck and shoulder. Height 36.8. Floor.
3. Red Polished II globular jug with round base; tall, tapering neck, splaying rim, and handle from neck to shoulder. Relief-ornaments on neck and shoulder. Not complete. Height 52.2. Floor.
4. Red Polished II oval jug with round base; tall, tapering neck, splaying rim, and handle from neck to shoulder. Relief-ornaments on neck and shoulder. Rim chipped. Height 50.7. Floor.
5. Red Polished III globular jug with cylindrical neck, splaying rim, and handle from neck to shoulder. Height 52.0. Floor.
6. Red Polished III globular jug with round base; narrow, convex neck; small, splaying rim, and a knobbed handle from neck to shoulder. Button-ornaments on the shoulder. Height 38.4. Floor.
7. Red Polished II jug as No. 4. Rim chipped. Height 51.5. Floor.
8. Red Polished II globular cooking-pot with wide neck, and two handles from rim to body. Height 21.3. Floor.
9. Red Polished III oval jug with round base; tall, cylindrical neck; flat rim, handle from neck to shoulder, and a string-hole projection opposite the handle. Incisions and rope-ornaments on neck and shoulder. Handle missing. Height 56.9. Floor.
10. Red Polished II jug as No. 3. Rim missing. Height 56.8. Floor.
11. Fragments of a large Red Polished II jug. Floor.
12. Red Polished II jug as No. 4. Upper part of neck missing. Height 42.8. Floor.
13. Red Polished III hemispherical bowl with a string-hole projection at the rim. Even red. Diam. 15.4. Floor.
14. Bronze pin with pointed end and thickening head. Length 23.0. Floor.
15. Bronze pin as No. 14. Length 17.3. Floor.

The Object Register is summed up as below.

P o t t e r y		Bronze
R. P. II	R. P. III	Pins
1, 2, 3, 4, 7, 8, 10, 11, 12 -9	5, 6, 9, 13 -4	14, 15 -2

CHRONOLOGY

The four vases of Red Polished III Ware are all early specimens of their types. They were found in different parts of the chamber, and seem to have been represented in both burials. This dates the tomb to an early stage of E. C. III, and corroborates the presumption that the two burials are separated by only a rather short time.

TOMB 318 (Figs. 48; 49: 5; 150: 1)

	S I Z E			
	Length	Width	Depth	Height
Dromos	2.38	1.40	1.20	—
Stomion	0.68	0.86	—	0.55
Chamber	2.62	3.73	—	1.55

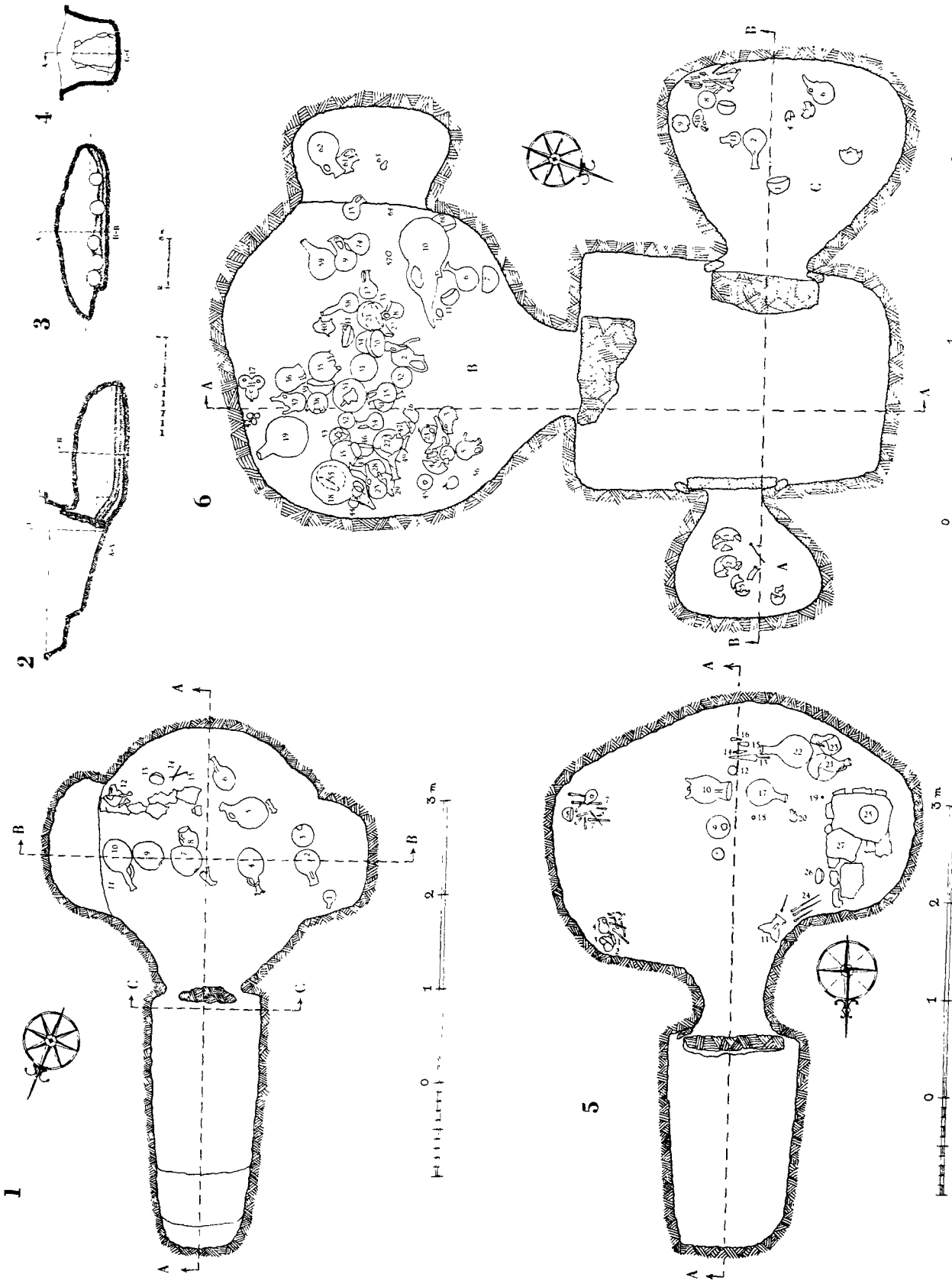

Fig. 49. Lapithos. Tomb 317, Plan (1); Sections A-A, B-B, C-C (2, 3, 4). Tomb 318, Plan (5). Tomb 319, Plan (6).

SHAPE

The dromos is bucket-shaped and widens slightly towards the entrance of the chamber. The sides taper downwards, and the floor slopes southwards. Just in front of the door is a narrow groove, preventing the heavy door stone from slipping. One single chamber opens out from the dromos. It has an irregularly oval shape with horizontal floor, and a curved roof. The stomion is tunnel-shaped, slopes gently down to the level of the chamber floor, and widens considerably on the inside. In the W. side of the chamber is a low bench built of flat stones. Opposite the entrance in the N. apsidal end of the dromos is a small, oval cupboard closed by a circular stone, resting in a hollowed-out moulding.

STRATIFICATION

The dromos-filling consisted of three layers of *chavara*. The top layer was of light colour, loose consistency, and almost devoid of potsherds. The middle one contained a large amount of Red Polished II sherds, and the bottom stratum was dark and hard-packed with comparatively few sherds. The last layer ran from the lower edge of the cupboard to the threshold of the door. The stratification shows that the dromos has been partly excavated for a secondary burial, and it seems probable that the cupboard was cut at that time.

In the chamber a mass of debris from the roof covered the find stratum. This was of a considerable depth and mixed with silted clay. Pots and skeletal remains have, apparently, floated about in the chamber, and it is useless to try to reconstruct their original positions. There seemed to have been four bodies: two at the E. wall and two in the W. section of the tomb.

BURIALS

The bad state of preservation of the bones makes it impossible to define the burial customs. Of the two skeletons in the W. part of the chamber, one had, evidently, been placed on the stone bench and the second on some fragments of a large pithos (No. 27).

FINDS (GROUPS: PL. XXXII, 3, 5; TYPES: L. OF PL. II)

- | | |
|---|--|
| <ol style="list-style-type: none"> 1. Red Polished I deep bowl with round base, and a small knob at rim. Wavy, irregular edge. Black rim and inside. Diam. 12.5. Floor. 2. Black Polished hemispherical bowl with a string-hole projection at rim. A hatched zigzag band around rim, and hatched triangles, flanked by oblique, hatched bands, vertically arranged on body. Diam. 8.7. Floor. 3. Red Polished II hemispherical bowl with a string-hole projection at rim. Black rim and inside. Fragmentary. Diam. c. 16.0. Floor. 4. Red Polished III globular jug with round base, cylindrical, cut-away neck, and handle from neck to shoulder; a string-hole projection opposite the handle. Height 14.1. Floor. 5. Red Polished II bowl as No. 3. Diam. 13.6. Floor. 6. Red Polished III jug as No. 4, but without string-hole projection. Height 16.5. Floor. | <ol style="list-style-type: none"> 7. Straight bronze pin with thickening head and a flat wire wound around lower part of pin. Length 23.2. Badly corroded fragment of a bronze pin. Length 8.2. Floor. 8. Red Polished I bowl as No. 1. Even red. Rim chipped; knob missing. Diam. 11.1. Floor. 9. Red Polished III globular jug with round base, backwards-curved neck, beaked mouth, an incised handle from rim to shoulder, and a string-hole projection opposite the handle. Knobs and incised ornaments on neck and shoulder. Handle missing. Height 25.0. Floor. 10. Red Polished II globular vessel with round base, widening neck, straight rim, two handles from neck to shoulder, and three cylindrical solid legs. Neck decorated with friezes of hatched squares and zigzag bands, and body covered with a rich, vertically arranged decoration, composed of hatched zigzag and semicircular bands; |
|---|--|

- framed, hatched triangles and lozenges, and hatched band-elements. Bands of horizontal lines around legs, and hatched bands on handles. Surface partly badly worn. Height 38.5. Floor.
11. Red Polished III pear-shaped amphora with round base; convex narrowing neck, splaying rim, and two rather small, knobbed handles from neck to shoulder. Friezes of horizontal bands, partly filled with groups of oblique lines. Piece of rim missing. Height 24.5. Floor.
 12. Red Polished I hemispherical bowl. Even red. Diam. 10.4. Floor.
 13. Bronze dagger with straight sides, pointed end, midrib, narrow cuttings near the tang, and solid, hooked tang. Point broken. Length 38.9. Floor.
 14. Lancet-shaped bronze knife with concave sides, rounded shoulders, midrib, and flat narrow tang with rounded top; three rivets at the top. Length 14.1. Floor.
 15. Oblong bronze scraper with rounded ends. One rivet at the top. Length 9.4. Floor.
 16. Bronze tweezer with rounded top. Length 9.8. Floor.
 17. Red Polished III globular jug with round base, cylindrical neck; small, splaying rim, and handle from neck to shoulder. Height 38.0. Floor.
 18. Red Polished conical spindle-whirl with incisions. Diam. 4.5. Floor.
 19. Spindle-whirl as No. 18. Diam. 4.5. Floor.
 20. Red Polished III jug as No. 6. Height 12.0. Floor.
 21. Red Polished II globular jug with round base, concave neck, splaying rim, and handle from rim to shoulder. Damaged. Floor.
 22. Red Polished III jug as No. 17, but with incised lines and dots on neck and shoulder. Height 54.5. Floor.
 23. Red Polished III globular amphora with round base, cylindrical neck; stilted, flat rim, and two angular handles from neck to shoulder. Zigzag lines and dots incised on neck and shoulder. Damaged. Floor.
 24. Four bronze pins.
Straight bronze pin with thickening top, small button-head, pointed end, and an eyelet at middle of pin. Length 33.0.
Bronze pin as the above described. Length 33.0.
Plain straight pin with thickening top and pointed end. 22.0.
Bronze pin as the above described. Length 21.5. Floor.
 25. Red Polished II bowl as No. 3. Black rim and inside. Rim chipped. Diam. 16.3. Floor.
 26. Red Polished II bowl as No. 3. Rim chipped. Diam. 17.0. Floor.
 27. Fragment of a Red Polished II large pithos. Floor.

Dromos cupboard

1. Fragments of a Red Polished II hemispherical bowl.
2. Red Polished II globular jug with round base; concave, narrow neck, splaying rim, and handle from rim to shoulder. Damaged. Height 14.0.

A classification of the finds gives the following diagram:

	Pottery				Terracotta	Bronze				
	R. P. I	R. P. II	R. P. III	Bl. P.	Spindle-whirls	Pins	Knife	Dagger	Scraper	Tweezer
Chamber	1, 8, 12 -3	3, 5, 10 21, 25, 26 27 -7	4, 6, 9 11, 17, 20 22, 23 -8	2 -1	18, 19 -2	7, 7 24, 24 24, 24 -6	14 -1	13 -1	15 -1	16 -1
Dromos		1, 2								
Cupboard		-2								

CHRONOLOGY

It is easy to see that the tomb has been used over a long period. The presence of three typical Red Polished I bowls is striking, and they date the construction of the tomb to, at least, as remote a period as the beginning of E. C. II. With this date the primitive shapes of dromos and chamber correspond very well. The newest finds in the tomb belong to the beginning of E. C. III during which epoch also the cupboard in the dromos was constructed.

TOMB 319 (Figs. 49: 6; 50: 4—5)

	SIZE			
	Length	Width	Depth	Height
Dromos	1.95	1.32	1.00	—
Stomion A	0.13	0.32	—	0.28
Chamber A	0.58	0.81	—	0.55
Stomion B	0.25	0.60	—	0.48
Chamber B	1.72	2.24	—	1.16
Stomion C	0.15	0.47	—	0.27
Chamber C	0.98	1.31	—	0.80

SHAPE

The dromos is small and bucket-shaped widening towards the stomion, with perpendicular walls and horizontal floor. In the semicircular end of the dromos is a narrow step half the height of the wall. A small chamber opens from each long side and a larger one from the S. short side of the dromos. The former are of roughly triangular shape with rounded corners, short stomia, horizontal floors, perpendicular walls and flat roofs. Their doors were blocked by single slabs, wedged with smaller stones. The central chamber (B) is circular with a small niche above the level of the floor, on the W. side. Roof and walls form a curved vault. The stomion, which slopes abruptly inwards, was closed by a large, thick block of heavy calcareous stone.

STRATIFICATION

The dromos-filling consisted of homogeneous *chavara* material containing many Red Polished potsherds of coarse type. The small size of the dromos has, evidently, caused the total excavation of the filling matter every time a secondary burial took place.

There is not very much to be said about the stratification in the chambers. All the finds and the skeletal remains were found on the floors; in the small chambers (A and C) some earth had poured in from the dromos, forming fan-shaped layers, covering the regions close to the stomia, and in Chamber B some debris had fallen from the roof without causing any damage to the deposits. In each of the small chambers a child's skeleton was found, and in the central chamber were two skeletons of adults, one along the E. and one along the W. wall. The small niche was not occupied by any skeletal remains. It is useless to try to separate the tomb-gifts of Chamber B into groups assignable to the respective burials, or to state their relative chronology. The chamber floor was crowded with pottery, and noticeable distinction between the tomb-gifts belonging to the one, or the other body was lacking.

BURIALS

The tomb gave evidence for the singular habit of burying children in separate miniature chambers, but the preservation of the skeletal material was too bad, to permit of any conclu-

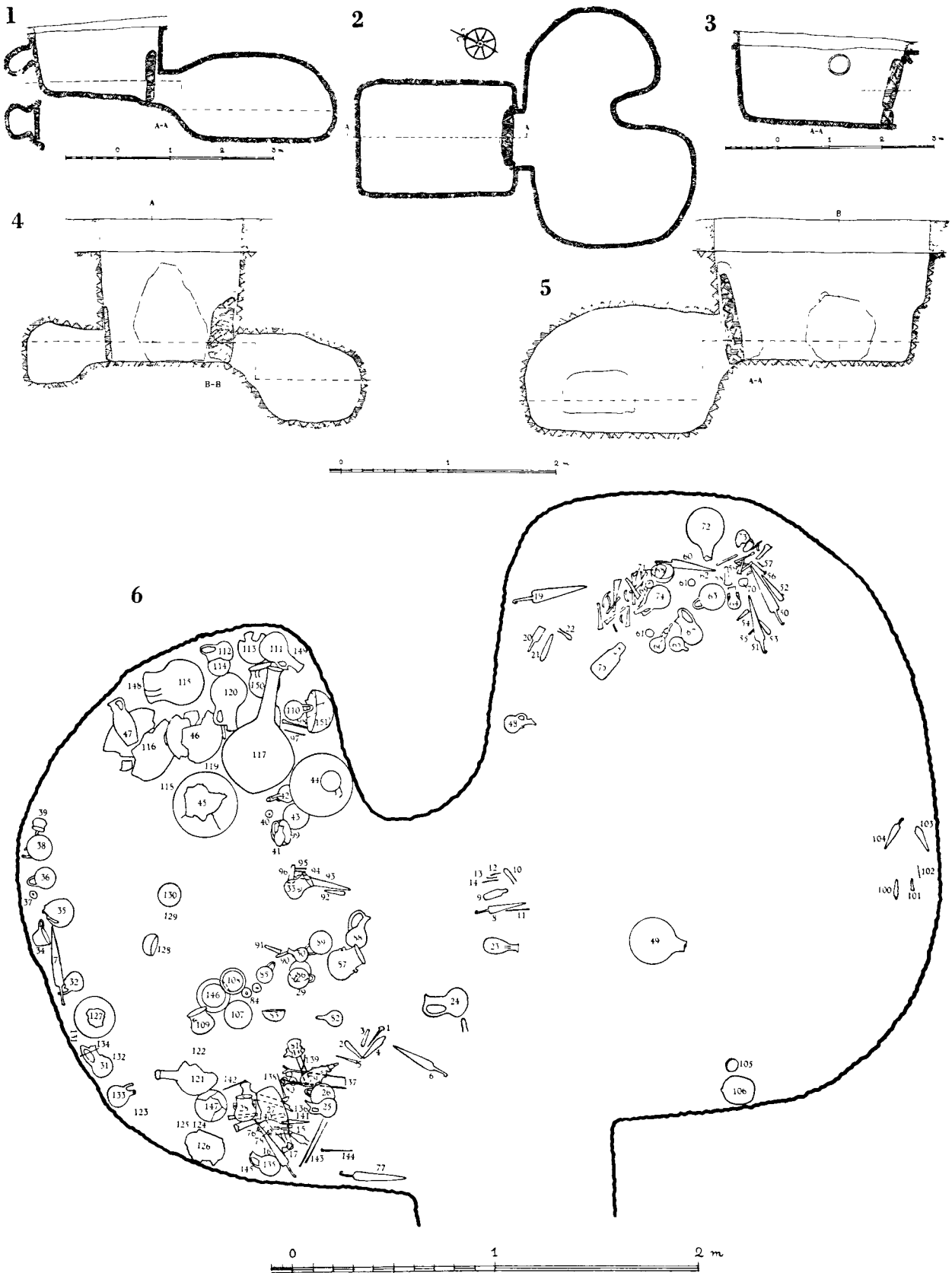

Fig. 50. Lapithos. Tomb 318, Section A-A (1). Tomb 319, Sections B-B, A-A (4, 5). Tomb 320, Plan (2); Section A-A (3); Finds *in situ* (6).

sions regarding the original positions of the dead bodies. In the central chamber the bones were crushed by the mass of tomb-gifts.

FINDS (GROUPS: PLS. XXXII, 6—7, XXXIII; TYPES: L. OF PL. II)

C h a m b e r A

1. Fragments of a Red Polished II hemispherical bowl. Floor.
2. Black Polished almost hemispherical bowl with a string-hole projection at rim. A hatched band around rim; a zigzag line with hatchings around body, and encircling lines around base. Not complete. Floor.
3. Fragments of a Red Polished II jug. Floor.
4. Bronze pin with thickening head. Length 15.0. Floor.
5. Red Polished III jug with cylindrical neck, splaying rim, knobbed handle from neck to shoulder, and a string-hole projection opposite the handle. Zigzag lines on neck. Not complete. Floor.
6. Fragments of a Red Polished II jug. Floor.

C h a m b e r B

1. Fragments of a Red Polished III incised bottle. Floor.
2. Red Polished III pear-shaped jug with round base, cylindrical neck; small, splaying rim; a high handle from rim to shoulder; a spout opposite the handle, and a string-hole projection between neck and shoulder. Zigzag bands and circles around the shoulder, and a vertical rope-ornament from string-hole to spout. Height 21.7. Floor.
3. Red Polished III jug as No. 2, but with handle from neck to shoulder. Piece of spout missing. Height 16.0. Floor.
4. Fragments of a Red Polished III jug with beaked mouth. Floor.
5. Red Polished III jug as No. 3. Vertical bands of zigzag lines on the sides, hatchings on neck and handle, and groups of impressed dots below and opposite the handle. Height 15.7. Floor.
6. Red Polished II oval jug with round base, tapering neck, wide funnel-rim, and handle from rim to shoulder. Hatchings on neck; encircling bands of parallel lines around shoulder and belly; bands of chevrons, alternating with hatched bands and concentric circles, from shoulder to belly. Height 20.0. Floor.
7. Red Polished III hemispherical bowl with a string-hole handle at rim. Diam. 14.3. Floor.
8. Red Polished III conical jug with flattened base; wide, short neck; small, stilted rim, a high twin-handle from rim to shoulder, and a string-hole projection opposite the handle. Height 9.5. Floor.
9. Red Polished II jug as No. 6, but with a horizontal knob opposite the handle, and a small projection on rim. Encircling bands of parallel lines around neck, shoulder and base, and a broad band of hatched triangles and lozenges around body. Height 20.2. Floor.
10. Red Polished III oval jug with round base, backwards-curved neck; high, beaked mouth, a twin-handle from rim to shoulder, a profiled string-hole projection between neck

- and shoulder, and two conical knobs below and opposite the handle. Incised straight and wavy rope-ornaments in relief around neck and shoulder, vertical hatchings on handle, and from neck to belly; zigzag lines from top of mouth to shoulder. Rim chipped. Height 61.5. Floor.
11. Red Polished III bowl as No. 7. Encircling bands of parallel lines around rim and base; a broad band of hatched lozenges around body. Even red. Rim chipped; paint worn. Diam. 10.0. Floor.
 12. Red Polished II jug as No. 6. Encircling bands of parallel lines around neck, shoulder, belly, and base; broad bands around shoulder and belly, consisting of vertical lattice-bands, concentric semicircles and half lozenges, completed by semicircular and angular hatched bands in regular alternations. Height 16.6. Floor.
 13. Red Polished II jug as No. 6. Encircling bands of parallel lines around neck, shoulder, belly, and base, and two bands of hatched lozenges around body. Height 15.5. Floor.
 14. Red Polished II jug as No. 6. Encircling bands of parallel lines around neck, shoulder, belly, and base, and two bands of parallel zigzag lines around body. Height 17.9. Floor.
 15. Red Polished II jug as No. 6. Encircling bands of parallel lines around neck, shoulder and base; body covered with a decoration consisting of concentric circles and hatched lozenges. Surface partly worn. Height 17.5. Floor.
 16. Red Polished III bowl as No. 11. Diam. 9.1. Floor.
 17. Red Polished III coupled vase composed of two oval jugs with round bases, cylindrical necks, flat rims, and string-hole handles between necks and shoulders, and of a third jug of similar shape, but with beaked mouth and tubular spout; a high basket handle on the centre of the vase. Hatchings on necks and handles, and vertical bands of parallel, oblique bands on the small vases. Spout missing. Height 16.9. Floor.
 18. Red Polished III jug as No. 10, but with twisted handle. Straight and wavy rope-ornaments around neck, and hatchings on handle. Top of mouth missing. Height 43.5. Floor.
 19. Red Polished II globular jug with round base, cylindrical neck, and handle from neck to shoulder. Rim missing. Height 31.2. Floor.
 20. Red Polished II hemispherical bowl. Rim badly chipped. Diam 16.0. Floor.
 21. Red Polished II hemispherical bowl with a string-hole projection at rim. Diam. 15.0. Floor.
 22. Black Polished hemispherical bowl with a string-hole handle at rim. Encircling bands of parallel lines around rim and base, and a band of parallel zigzag lines around body. Much damaged. Floor.

23. Red Polished III pear-shaped jug with round base, backwards-curved neck, beaked mouth, handle from rim to shoulder, a tubular spout on shoulder, and a string-hole projection opposite the handle. Encircling bands of parallel lines around rim and spout; hatched bands around neck, root of handle, and spout; zigzag lines around body, and on front of neck; hatchings on rim and handle, and groups of impressed dots on neck and body. Height 21.3. Floor.
24. Fragments of a Red Polished III jug, similar to No. 5. Floor.
25. Black Polished bowl as No. 22. Diam. 9.5. Floor.
26. Red Polished III miniature cooking-pot with three legs, handle from rim to body, and a hooked projection opposite the handle. Legs missing. Height 7.5. Floor.
27. Red Polished III pear-shaped jug with round base; tall, cylindrical neck, splaying rim, and handle from neck to shoulder. Damaged. Height 28.3. Floor.
28. Red Polished II jug as No. 6. Encircling bands of parallel lines around neck, shoulder and base, and two bands of hatched lozenges around body. Height 21.7. Floor.
29. Red Polished III jug as No. 5. Vertical, dotted zigzag lines on neck and body; hatchings on handle, and as front ornament, and groups of impressed dots on body. Rim chipped. Height 15.7. Floor.
30. Red Polished III pear-shaped jug with round base, conical shoulders; tall, tapering neck, wide funnel-rim, and handle from rim to shoulder. Encircling bands of parallel lines around neck, shoulder, and base, and bands of hatchings and zigzag lines around body. Handle missing; rim chipped. Paint worn. Height 17.7. Floor.
31. Red Polished II bowl as No. 21. Diam. 14.4. Floor.
32. Red Polished III bowl as No. 11. Diam. 10.9. Floor.
33. Red Polished III oval jug with round base, cylindrical neck, beaked mouth, a handle from rim to shoulder, and a projection opposite the handle. Top of mouth missing. Surface much worn. Height 25.4. Floor.
34. Red Polished III vase composed of two super-imposed jugs. The top jug has a globular body, backwards-curved neck, beaked mouth, a twin-handle from rim to shoulder, and a projection at root of handle. The lower jug is pear-shaped with round base, cylindrical neck, handle from neck to shoulder, and a tubular spout opposite the handle. A zigzag band around body of the lower jug, and hatchings on necks, shoulders, and handles of both jugs. Spout missing. Height 29.1. Floor.
35. Red Polished III globular cooking-pot with wide neck, and two handles from rim to body. Rim chipped; one handle missing. Height 19.1. Floor.
36. Red Polished III cooking-pot as No. 35. Height 16.7. Floor.
37. Red Polished III jug as No. 23. Vertical rope-ornaments on shoulder, a wavy relief line below handle, and hatchings on neck and handle. Height 10.9. Floor.
38. Red Polished III jug as No. 5. Hatchings and vertical bands of oblique, parallel lines on neck and body, and incised lines on handle. Height 16.3. Floor.
39. Red Polished III bowl as No. 7. Diam. 14.2. Floor.
40. Red Polished III animal-shaped vase, with four legs, globular askos-shaped body, two necks, a twisted basket-handle at back, and a horizontal relief-line, resembling wings on each side of handle. Vertical bands of zigzag lines, covering the body; hatchings on necks, handle and wings, and an impressed dot on the back. Height 16.1. Floor.
41. White Painted III shallow bowl with round base, slightly inwards-turned rim, and a horizontal handle below rim. A band of hatched triangles around rim, and crossed straight and wavy lines outside and inside. Rim chipped. Height 11.6. Floor.
42. Red Polished III coupled vase of the same composition as No. 17. All the three small jugs have tubular spouts; one of them has a beaked mouth; necks and pieces of body of two of the jugs are missing, as well as the common handle. Zigzag lines, impressed dots, and hatchings on bodies. Height 12.1. Floor.
43. Red Polished III jug as No. 5. Not complete. Floor.
44. White Painted II coupled vase consisting of three deep, globular bowls with splaying rims, and a hooked projection on each rim; a flat, tall, staff-shaped handle in the centre. Broad, vertical lines and horizontal, straight and wavy lines on bowls and handle. Height 25.0. Floor.
45. Red Polished III pear-shaped amphora with round base; wide, cylindrical neck; small, flat rim, and two handles from neck to shoulder. Button-ornaments between handles; one handle missing. Paint worn. Height 17.2. Floor.
46. Red Polished III bowl as No. 11. Encircling bands of parallel lines around rim and base, and hatched lozenges around body. Even red. Diam. 9.4. Floor.
47. Fragments of an ovoid Red Polished III bottle. Floor.
48. Red Polished II jug as No. 6. A band of zigzag lines and hatched lozenges around belly; concentric circles, parallel, oblique lines, and hatchings on shoulder. Handle and neck missing. Surface worn. Height 10.2. Floor.
49. Black Polished bowl as No. 22. Encircling bands of parallel lines around rim and base, and hatched lozenges around body. Rim chipped. Diam. 7.3. Floor.
50. Black Polished pear-shaped jug with round base, and narrow, cylindrical neck. Encircling lines around neck and base, a hatched band around shoulder, and vertical bands of hatched triangles, alternating with hatched bands and squares around body. Neck partly missing. Height 8.7. Floor.
51. Red Polished III oval amphora, with round base, and two knobbed handles from neck to shoulder. Neck missing. Height 25.9. Floor.
52. Red Polished III bowl as No. 11. Parallel, oblique lines around rim, bands of parallel lines below rim and around base, and hatched triangles in antithetic groups around body. Even red. Diam. 8.9. Floor.
53. Red Polished III pear-shaped jug with round base. Encircling lines around neck, shoulder and base, and zigzag bands around body. Neck and handle missing. Surface badly worn. Much damaged. Floor.

54. Red Polished II jug as No. 6. Encircling lines around neck and base, a hatched band around shoulder, and vertical, straight and zigzag bands on body. Rim chipped. Height 15.5. Floor.
55. Red Polished II bowl as No. 21. Diam. 14.6. Floor.
56. Red Polished II jug as No. 6. Encircling lines around neck, shoulder and base; hatched triangles and a hatched band around body. Rim chipped. Height 19.5. Floor.
57. Red Polished biconical spindle-whirl with incised hatchings on the sides. Diam. 3.9. Floor.
58. White Painted II jug as No. 23, but without spout. Decoration obliterated. Height 22.1. Floor.
59. Red Polished III squat, globular jug with round base, cylindrical neck, flat rim, and handle from neck to shoulder. Not complete. Floor.
60. Red Polished III bowl with round base, two string-holes below rim, and small projections on rim. Diam. 14.5. Floor.
61. Red Polished III jug as No. 5. Spout missing. Height 16.4. Floor.
62. Red Polished III jug as No. 59. Rim chipped. Height 27.2. Floor.
63. Black Polished globular miniature jug, with cylindrical neck, and funnel-rim. Encircling lines around rim, shoulder and base, and hatched lozenges around body. Not complete. Height 4.0. Floor.
64. Flat spiral of bronze. Broken. Diam. 2.5. Floor.
- to shoulder, and a large, angular string-hole projection opposite the handle. Encircling bands of parallel lines around neck, shoulder and base; two zigzag bands around body. Rim and handle missing. Height 22.9. Floor.
3. Black Polished hemispherical bowl with a small string-hole projection at rim. Encircling bands of parallel lines around rim and base; vertical bands of parallel, oblique lines, and hatchings on body. Not complete. Floor.
4. Red Polished II bowl as No. 3. Not complete. Floor.
5. Fragments of a Red Polished II pear-shaped jug with incisions. Floor.
6. Red Polished III oval jug with round base; cylindrical, slightly backwards-curved neck, beaked mouth, handle from rim to shoulder, and a projection opposite the handle. Height 21.0. Floor.
7. Red Polished II bowl as No. 3. Black inside, red outside. Diam. 9.8. Floor.
8. Red Polished III bowl as No. 3. Encircling lines around base; bands of parallel lines, crossed by zigzag lines around rim; hatched lozenges around body. Not complete. Diam. 9.5. Floor.
9. Black Polished bowl as No. 3. A framed band of crossed zigzag lines around rim, a zigzag band around body, and encircling bands around base. Diam. 8.1. Floor.
10. Black Polished bowl as No. 3. Zigzag bands around rim, hatched lozenges and triangles around body, and encircling lines around base. Not complete. Floor.
11. Red Polished III pear-shaped jug, with round base; wide, cylindrical neck, splaying rim, and handle from rim to shoulder. Encircling bands of parallel lines around neck, shoulder and base; a zigzag band and hatchings around body. Handle missing. Height 11.5. Floor.
12. Two spherical paste-beads. Floor.

Chamber C

1. Red Polished III hemispherical bowl with a string-hole handle at rim. Even red. Diam. 12.2. Floor.
2. Red Polished III pear-shaped jug with round base; cylindrical, narrow neck, funnel-rim, handle from neck

A summary of the Object Register gives the following diagram:

	Pottery						Bronze		Terracotta	Faience		
	R. P. II	R. P. III				Wh. P. II	Wh. P. III	Bl. P.	Pins	Ring	Spindle-whirl	Bead
Chamber A	1, 3, 6 -3	5 -1						2 -1	4 -1			
Chamber B	6, 9, 12 13, 14, 15 19, 20, 21 28, 31, 48 54, 55, 56 -15	1, 2, 3, 4, 5, 7, 8 10, 11, 16, 17, 18, 23, 24 26, 27, 29, 30, 32, 33, 34 35, 36, 37, 38, 39, 40, 42 43, 45, 46, 47, 51, 52, 53 59, 60, 61, 62 -39	44, 58	41	22, 25 49, 50 63			64	57			
Chamber C	4, 5, 7 -3	1, 2, 6, 8, 11 -5				-2	-1	3, 9 10 -3				12 -1

CHRONOLOGY

The majority of the finds consist of Red Polished III pots, but the presence of a few specimens of the White Painted Ware gives the tomb its date, the later part of E. C. III.

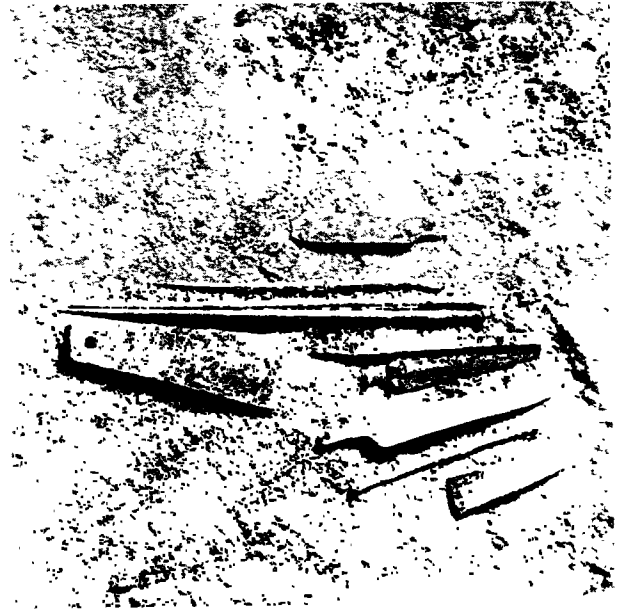
Fig. 51. Lapithos. Tomb 320. Finds *in situ*.Fig. 52. Lapithos. Tomb 322 A. Hord of bronzes *in situ*.

TOMB 320 (Figs. 50: 2—3,6; 51)

	SIZE			
	Length	Width	Depth	Height
Dromos	3.18	2.08	1.47	—
Stomion	0.42	1.02	—	c. 1.00
Chamber	3.05	4.45	—	—

SHAPE

The tomb has a large rectangular dromos with rounded corners, perpendicular sides, and horizontal floor. It is provided with three small cupboards cut around the edge. One single tomb-chamber opens from the S. short side. The chamber is heart-shaped with a central projection in the back wall, dividing the room into two sections. Down to the chamber leads a wide tunnel-shaped stomion, blocked by a slab of local limestone, kept in position by smaller wedging stones. The plan of the tomb, thus, strongly resembles that of Tomb 316. The roof of the chamber had fallen in and the excavation had to be carried out from above. It was, consequently, impossible to make any notes regarding the original height of the chamber and of the shape of the roof.

STRATIFICATION

The earth, filling the dromos, consisted of *chavara* stratified in three layers, all containing many potsherds of the Red Polished III and the White Painted II and III classes. The bottom layer was wedge-shaped with its thinner end close to the door, indicating that the

dromos has only been partly excavated at a secondary burial. As the chamber was found fallen in, the whole area was filled with debris of the rock. The find stratum contained much damaged pottery, and was partly mixed with wet, silted clay. The finds lay on the floor or raised a few centimetres above it in the moist clay. Close to the back wall of the E. half of the chamber was found a deposit of pots (Nos. 45—49 and 109—122) on a considerably higher level. That part of the chamber was connected with Tomb 323 D and the deposit had been disturbed by mud and water, flowing in from the neighbouring tomb. It might, perhaps, have fallen from that chamber down in this tomb (see below p. 158). The bodies could only be traced as dark strata mixed with mouldered skeletal remains. Probably seven burials had taken place, six along the walls and one in the central part of the E. half of the chamber. The evidence is not sufficient to render it possible to state the chronological order of the burials, and it seems safer to treat them as a single group.

BURIALS

Nothing can be said about the burial customs either, as the skeletal material was in a very bad state of preservation.

FINDS (GROUP: PL. XXXIV; TYPES: L. OF PL. II)

1. Bronze pin with "mushroom-head", and an eyelet through the middle. Length 13.2. Floor.
2. Leaf-shaped bronze knife with concave sides, low midrib, and rounded top with two rivet-holes. Length 11.0. Floor.
3. Fragments of a thick bronze pin. Badly corroded. Length 7.9. Floor.
4. Leaf-shaped bronze knife with convex sides, low midrib, and rounded top with three rivet-holes. Length 15.5. Floor.
5. Bronze pin with button-head and an eyelet through the middle. Incised herring-bone patterns and zigzags. Length 11.0. Floor.
6. Leaf-shaped bronze dagger with two edges, pointed end, high midrib, cuttings near the tang, and hooked, solid tang. Length 30.5. Floor.
7. Bronze dagger as No. 6. Length 39.4. Floor.
8. Bronze dagger as No. 6. Length 26.0. Floor.
9. Bronze scraper with two edges, straight sides and end, low midrib; flat, tapering tang, and one rivet-hole through tang. Edge chipped. Length 12.4. Floor.
10. Bronze tweezer with rounded top and widening arms. Length 9.2. Floor.
11. Straight bronze pin with thickening head. Length 10.8. Floor.
12. Bronze needle with an eyelet through head. Length 4.9. Floor.
13. Bronze needle as No. 12. Point missing. Length 8.6. Floor.
14. Bronze needle as No. 12. Head missing. Length 8.9. Floor.
15. Bronze knife as No. 4. Length 14.5. Floor.
16. Bronze dagger as No. 6. Length 34.7. Floor.
17. Bronze axe with splaying sides and curved edge. Length 9.5. Floor.
18. Bronze tweezer as No. 10. Length 8.9. Floor.
19. Bronze dagger as No. 6, but with triangular outline. Length 38.7. Floor.
20. Bronze scraper with two edges, low midrib, flat end, and long, solid tang. Edge chipped. Length 13.3. Floor.
21. Bronze knife as No. 2. Length 15.1. Floor.
22. Bronze tweezer as No. 10. Length 9.6. Floor.
23. White Painted III oblong bottle, with round base; narrow, cylindrical neck, splaying rim, and handle from neck to shoulder. Encircling lines around neck; square and oblong chess-board patterns on body, and a framed, wavy line around base. Paint worn. Height 17.2. Floor.
24. White Painted III globular jug with round base, cylindrical neck, splaying rim, oblique mouth, and an elevated handle from rim to shoulder. Bands of latticed triangles and lozenges around neck and body. Paint worn. Height 22.2. Floor.
25. White Painted III pear-shaped jug with round base, cylindrical neck, beaked mouth, and a knobbed handle from rim to shoulder. Encircling lines around neck and base, hatchings on handle, and broad lattice-bands and parallel zigzag lines from neck to base. Paint worn. Height 15.9. Floor.
26. White Painted III shallow bowl with round base, and a horizontal handle at rim. A band of parallel, oblique lines around rim, a framed, wavy line on base; parallel, oblique lines from rim to base; encircling wavy lines and crossed lines inside; transverse lines on handle. Paint worn. Diam. 11.5. Floor.

27. Red Polished IV sack-shaped bottle, with flat base; short, cylindrical neck, beaked mouth, and handle from rim to shoulder. Rim chipped; paint worn. Height 31.0. Floor.
28. White Painted III globular amphora with round base; cylindrical wide neck, stilted rim, and two profiled handles from neck to shoulder. Encircling lines around neck, shoulder, and belly; zigzag lines around neck and base, lattice-lozenges around shoulder; an encircled dot on base, oblique lines on rim, and framed, wavy lines below handles. One handle missing. Height 12.8. Floor.
29. White Painted III bowl as No. 26. A band of framed, hatched triangles around rim, crossed straight and wavy lines outside and inside, and transverse lines on handle. Rim chipped. Diam. 11.1. Floor
30. Black Slip II pear-shaped jug with round base; narrow, tapering neck, splaying rim, and a small handle from neck to shoulder. Paint worn. Height 9.3. Floor.
31. Red Polished IV globular jug with flat base, cylindrical neck, splaying rim, oblique mouth, a high, angular handle from rim to shoulder, and a string-hole projection opposite the handle. Paint worn. Height 17.8. Floor.
32. Red Polished II pear-shaped jug with round base, and handle from rim to shoulder. Concentric circles, vertical and oblique bands of parallel lines, and parallel, hooked lines on body. Neck and rim missing. Height 16.1. Floor.
33. Black Slip II squat, globular jug with flattened base; wide, cylindrical neck, splaying rim, handle from rim to shoulder, and a profiled string-hole projection opposite the handle. Incised zigzag lines around neck and body. Height 13.8. Floor.
34. White Painted III conical cup with flat base, profiled rim, and a high handle from rim to body. Oblong, chess-board patterns outside; vertical, wavy lines inside; a band of parallel, oblique lines inside rim, and transverse lines on handle. Height 7.7. Floor.
35. Red Polished III pear-shaped jug with round base; neck and piece of handle missing. Paint worn. Height 16.0. Floor.
36. White Painted III bowl as No. 26. A band of parallel, oblique lines around rim; a wavy line inside rim; crossed bands of parallel lines outside and inside, with short, wavy lines as filling ornaments; transverse lines on handle. Diam. 10.4. Floor.
37. Black Polished oval spindle-whirl, with incised bands on the sides. Diam. 4.0. Floor.
38. White Painted III bowl as No. 26. Hatched triangles around rim, a wavy line inside rim, crossed, wavy lines outside and inside with small circles as filling ornaments; transverse lines on handle. Piece of handle missing. Diam. 12.3. Floor.
39. White Painted III, deep bowl with round base, splaying rim, and a high handle from rim to body. A band of parallel, oblique lines below rim, crossed lines on base, and transverse lines on handle. Height 7.4. Floor.
40. Black Slip biconical spindle-whirl with incised lines on the sides. Paint worn. Diam. 4.2. Floor.
41. Black Slip III biconical jug, with raised base, cylindrical neck, splaying rim, a high twin-handle from rim to shoulder, and string-hole projections on handle, neck, and belly. Straight and wavy relief-lines around neck, shoulder and belly; impressed dots and wavy relief-lines on rim and handle. Paint worn. Height 11.8. Floor.
42. Red Polished IV pear-shaped jug with round base, cylindrical neck, beaked mouth, handle from rim to shoulder, and four string-hole projections around neck. Rim chipped; paint worn. Height 14.9. Floor.
43. Red Polished III hemispherical bowl with a string-hole projection at rim. Black rim and inside. Rim chipped. Diam 11.6. Floor.
44. Black Slip II oval jug with round base, cylindrical neck, splaying rim, oblique mouth, handle from neck to shoulder, and a string-hole projection opposite the handle. Paint worn. Height 42.4. Floor.
45. Fragments of a large, globular Red Polished III jug. Floor.
46. Fragments of a large Red Polished III jug. Floor.
47. White Painted III flat, oblong bottle with flat base; convex, tapering neck, splaying rim, and handle from rim to shoulder. A framed, wavy line around neck; bands of hatched triangles, lozenges, and crossed lines around body; crossed lines on base; a wavy line inside rim, and a vertical band of parallel zigzag lines from neck to base as front ornament. Paint worn. Height 24.1. -- 68.
48. White Painted III jug as No. 25, but with handle from neck to shoulder, and a string-hole projection opposite the handle. Encircling lines around neck and belly, broad lattice-bands from neck to base, crossed lines on base, and a wavy line on handle. Height 15.8. -- 27.
49. Red Polished III globular jug with round base, cylindrical neck, beaked mouth, and handle from rim to shoulder. Not complete. Height 28.1. -- 59.
50. Bronze dagger as No. 19. Length 33.5. Floor.
51. Bronze dagger as No. 19. Length 29.7. Floor.
52. Bronze knife as No. 2. Length 15.0. Floor
53. Leaf-shaped bronze knife with straight sides, low midrib, two edges, and rounded top with two rivet-holes. Length 7.3. Floor.
54. Bronze tweezer as No. 10. Length 7.3. Floor.
55. Piece of a bronze pin. Length 5.5. Floor.
56. Bronze pin as No. 1. Length 7.6. Floor.
57. Bronze awl with square section, and tapering tang. Length 5.3. Floor.
58. Bronze axe with widening sides and convex edge. Length 9.5. Floor
59. Bronze tweezer as No. 10, but with loop-shaped top. Broken. Length 7.0. Floor.
60. Bronze dagger as No. 19. Length 30.9. Floor.
61. Two circular bronze rings with overlapping ends. Diam. 4.2. Floor
62. Flat circular bronze ring with overlapping ends. Diam. 2.2. Floor.
63. White Painted III bowl as No. 26. Bands of parallel, oblique lines around rim and on base; a wavy line inside

- rim, crossed lines inside, and transverse lines on handle. Diam. 13.4. Floor.
64. White Painted III conical jug with round base; tall, cylindrical neck, splaying rim, and two profiled handles, pierced by string-holes, from neck to shoulder. Lattice-triangles on shoulder. Decoration almost obliterated. Height 10.9. Floor.
65. White Painted III shallow bowl with round base; flat, profiled rim, and a high handle from rim to body. Hatched triangles around rim; a wavy line around base; an encircled dot on base; crossed lines inside, and transverse lines on rim and handle. Diam. 8.0. Floor.
66. White Painted III pear-shaped jug with round base, cylindrical neck, a circular mouth on side of neck; a tubular spout; a knobbed handle from neck to shoulder, and string-hole projections on neck and shoulder. Encircling lines round spout and neck; network pattern on sides of body; framed zigzag bands below and opposite the handle, and crossed lines on base. Height 16.4. Floor.
67. White Painted III oval jug with round base, cylindrical neck, splaying rim, pinched mouth, and a high handle from rim to shoulder. Encircling lines around rim, neck, and base; lattice-bands and wavy lines from neck to base, and a wavy line on handle. Height 19.2. Floor.
68. White Painted III oblong bottle with flat base, cylindrical neck, splaying rim, and handle from neck to body. Encircling lines around neck, and square and oblong chess-board patterns on body. Height 9.9. Found in 61.
69. Red Polished globular spindle-whirl with flat ends, and incised zigzag lines on the sides. Diam. 3.9. Floor.
70. Oval mace-head of stone with flat ends, and a tapering hole through centre. Diam. 4.0. Floor.
71. Red Polished III bowl, as No. 43. Diam. 10.5. Floor.
72. Red Polished III globular jug with round base, tapering neck, beaked mouth, and handle from rim to shoulder. Rim chipped; pieces of body missing. Height 24.8. Floor.
73. Red Polished III pear-shaped jug with round base. Encircling bands of parallel lines around shoulder and base, a hatched zigzag band around body, and hooked and straight, short lines as filling ornaments. Neck, handle, and pieces of base missing. Surface worn. Height 8.9. Floor.
74. Red Polished III pear-shaped jug with round base; narrow, cylindrical neck, and a knobbed handle from neck to shoulder. Encircling bands of parallel lines around neck, shoulder, and base; concentric circles and hatched, vertical zigzag bands on body; parallel zigzag lines as front ornament; short, horizontal and oblique lines as filling ornaments, and irregular hatchings on handle. Rim missing. Height 20.7. Floor.
75. Red Polished flat idol. The idol consists of a plank-shaped, rectangular body with rectangular head; the shoulders are slightly indented and end in knobs. Decoration on the front: Around neck and on breast are incised concentric semicircles, arranged in bands of parallel lines, and in hatched bands suggesting necklaces. The exterior semicircle is adorned with small groups of impressed dots, evidently suggesting the larger beads of the necklace, which, consequently, is symmetrically arranged (cf. the reconstruction of the necklace in Tomb 322 B.) The lower part of body is occupied by transverse borders of horizontal and zigzag lines suggesting the embroidery on the dress.
- Decoration on the back: The hair is rendered as vertical, parallel zigzag lines falling towards the neck. The shoulder and upper part of back are covered with a chess-board pattern of short, horizontal lines, and the lower part is decorated with two broad bands of hatched triangles, all conventionally rendering the ornaments of the dress. The dress has evidently been a long gown, girdled at waist. Head missing. Length 19.9. Floor.
76. White Painted III oblong, oval bottle with flat base, two narrow, cylindrical necks with beaked mouths, and a vertical handle on the shoulder. Encircling lines around necks; broad lattice-bands on sides of body; a latticed and filled chess-board pattern on front and back of body; two lattice-lozenges opposite the handle; short, horizontal, wavy lines as filling ornaments, and a wavy line on handle. Height 17.0. Floor.
77. Bronze dagger as No. 6. Length 33.2. Floor.
78. Flat, circular bronze ring. Diam. 1.4. Floor.
79. White Painted III flat bottle with round base; short, cylindrical neck; round mouth on side of neck; a tubular spout at end of neck; a knobbed handle from neck to body, and string-hole projections on sides of neck and body. Encircling straight and wavy lines around spout and neck, and oblong chess-board patterns on body. Height 20.0. Floor.
80. Black Polished conical spindle-whirl with incised, concentric semicircles close to base. Diam. 4.1. Black Polished flat spindle-whirl with incised, concentric circles on sides. Diam. 3.5. Red Polished cylindrical spindle-whirl. Length 3.1. Floor.
81. White Painted III shallow bowl with round base, and a handle from rim to body. Hatched triangles around rim; straight and wavy lines on base, and concentric, wavy lines inside. Not complete. Floor.
82. Red Polished III globular bottle with round base; tall, tapering neck, plain rim, and two string-holes below rim. Encircling bands of parallel lines around neck; hatched bands around shoulder and belly; a band of hatched triangles around body, and vertical, hatched bands from shoulder to belly. Height 13.1. Floor.
83. Red Polished II hemispherical bowl with inwards-turned rim, and a small horizontal handle below rim. Black rim and inside. Diam. 11.4. Floor.
84. Two Black Slip almost spherical spindle-whirls. Diam. 3.8; 3.9. Floor.
85. White Painted III bowl as No. 26. A band of parallel, oblique lines around rim, a hatched band, flanked by two zigzag lines on base, and transverse lines on handle. Paint worn. Diam. 7.8. Floor.
86. White Painted III deep bowl with round base; small rim, and a high handle from rim to body. Decoration obliterated. Height 11.1. Floor.

87. White Painted III squat, globular amphora with flattened base; tapering, convex neck; flat rim, and two small, knobbed handles from neck to shoulder. Bands of lattice-triangles around neck and body, a wavy line around base, and crossed lines on base. Paint worn, rim chipped. Height 18.5. Floor.
88. White Painted III globular jug, with round base; tall, tapering neck, splaying rim, and handle from rim to shoulder. Encircling lines around neck, bands of hatched and latticed triangles around body, parallel zigzag lines around base, and transverse lines on handle. Height 16.5. Floor.
89. White Painted III shallow bowl, with round base, inwards-turned sides, and a high, horizontal handle at rim. Parallel, oblique lines around rim, and crossed lines on base. Paint worn. Diam. 11.5. Floor.
90. Leaf-shaped thin bronze knife, with rounded top, and one rivet-hole. End missing. Length 11.0. Floor.
91. Bronze tweezer with widening arms. Top missing. Broken. Length 9.7. Floor.
92. Leaf-shaped bronze knife with straight sides, pointed end, two edges, low midrib, and rounded top with three rivet-holes. Length 10.2. Floor.
93. Bronze dagger as No. 19. Length 27.5. Floor.
94. Bronze knife as No. 92, but with concave sides, and four rivet-holes. Length 7.9. Floor.
95. Two straight, plain bronze pins. Length 7.8; 6.0. Floor.
96. Bronze axe with widening sides, and convex edge. Length 9.1. Floor.
97. Bronze needle with flattened head, pierced by an eyelet. Length 10.9. Floor.
98. Bronze pin with button-head, and an eyelet through the middle. Length 19.4. Floor.
99. Red Polished II bowl, as No. 83. A band of herringbone patterns around rim, and a band of parallel zigzag lines around body. Diam. 11.0. Floor.
100. Leaf-shaped bronze knife with slightly concave sides, two edges, low midrib, and rounded top with two rivet-holes. Length 10.3. Floor.
101. Bronze tweezer as No. 10. Length 6.0. Floor.
102. Bronze awl with square section and tapering tang. Length 6.2. Floor.
103. Leaf-shaped bronze knife as No. 100, but with three rivet-holes. Length 13.1. Floor.
104. Bronze dagger as No. 6. Length 17.0. Floor.
105. White Painted III pear-shaped jug with round base, widening neck, and handle from rim to body. Handle missing. Decoration obliterated. Height 8.0. Floor.
106. Black Slip II shallow bowl with round base, and a string-hole projection at rim. Diam. 16.3. Floor.
107. Red Polished III bowl as No. 43. Diam. 13.6. Floor.
108. Red Polished II deep, globular bowl with round base and splaying rim. Encircling lines below rim, and a hatched zigzag band around body; concentric lozenges as filling ornaments. Black rim and inside. Height 13.6. Floor.
109. White Painted III squat, globular amphora with flattened base, widening neck, stilted rim, and two handles from neck to body. Rim chipped. Decoration obliterated. Height 10.4. — 80.
110. Red Polished III shallow bowl with round base, and a high, horizontal handle at rim. Diam 9.3. — 70.
111. White Painted II pear-shaped jug with round base; tall, tapering neck, flat rim, and a knobbed handle from neck to shoulder. Encircling lines around neck; broad lattice-bands, alternating with bands of oblong chess-board patterns from neck to base, and concentric circles and wavy lines on base. Paint worn. Height 24.5. — 60.
112. White Painted III oval jug with round base, cylindrical neck, splaying rim, and handle from rim to shoulder. Decoration obliterated. Height 13.4. — 50.
113. Red Polished II bowl as No. 83. Rim chipped. Diam. c 17.0. — 65.
114. Fragments of a White Painted III bowl. — 60.
115. Red Polished III oval cooking-pot with round base; wide, concave neck, and two handles from rim to body. Incised lines on handles. Piece of rim missing. Height 29.7. — 64.
116. Fragments of a large Red Polished III jug. Floor.
117. Red Polished III biconical jug with round base, tall, tapering neck, widening rim, and handle from neck to shoulder. Rope-ornaments in relief around neck and shoulder. Rim chipped. Height 62.3. Floor.
118. Fragments of a Red Polished III amphora. Floor.
119. Fragments of a large Red Polished III jug with a plaited handle from neck to shoulder. Straight and wavy rope-ornaments in relief around neck and shoulder, impressed dots on neck, and hatchings on handle. Floor.
120. Red Polished III oval jug with flattened base; tapering, cut-away neck, splaying rim, and handle from neck to shoulder. Height 28.8. Floor.
121. Fragments of a Red Polished III jug. Floor.
122. Fragments of a Red Polished III jug. — 50.
123. Red Polished III globular jug with round base, cylindrical neck, beaked mouth, and handle from rim to shoulder. Not complete. Height 26.3. Floor.
124. Fragments of a Black Slip II jug. Floor.
125. Fragments of a Red Polished III jug. Floor.
126. Red Polished II oval pithos with flat, raised base, and widening rim. Not complete. Floor.
127. Red Polished III globular amphora with round base, and two handles from neck to shoulder. Not complete. Floor.
128. Red Polished III bowl as No. 43. Diam. 9.3. Floor.
129. Red Polished III ring-vase with three feet. On the rim are placed two small jugs and one open bowl, which all communicate with the ring and with each other. The ring is decorated with an encircling band of parallel zigzag lines; the jugs have encircling bands of parallel lines around necks, shoulders, and bodies, and zigzag lines around bellies; around the rim of the bowl is a band of parallel lines. The vase is much damaged and not complete. Height 17.5. Floor.

	Pottery							Bronze							Silver-lead	Faience	Stone	Terra-cotta					
	R. P. II	R. P. III	R. P. IV	Bl. P.	Bl. Sl. II	Bl. Sl. III	Wh. P. II	Wh. P. III	Pins	Needles	Knives	Daggers	Awls	Tweezers	Axes	Rings	Scrapers	Rings	Necklace	Mace-head	Spindle-whirls	Idol	
Chamber	126	116.	117					63.	64	139, 139		90	51	101								84	
	140	118.	119					65.	66	139, 143		92	60									84	
	147	120.	121					67.	68	143, 144		94	77										
		122.	123						76.	79			100	93									
		125.	127						81.	85			103	104									
		128.	129						86.	87			141										
		132.	133						88.	89													
		134.	136						105.	109													
		146.	148						112.	114													
		149.	150						135														
		151																					
	-9	-33	-3	-1	-6	-1	-1	-31	-18	-5	-12	-11	-2	-7	-3	-4	-2			-1	-1	-8	-1
Cup-board 1		1			2													3.	3				
		-1			-1													-2					
Cup-board 2		1						2.	3														
		-1						-2															
Cup-board 3								1										2	2,	2			
																		2.	2	2			
								-1										-6					

CHRONOLOGY

The distribution of the finds very much resembles that of Tomb 316 and the tomb should be dated to the same period, i e. M. C. II. It is, however, possible that some of the earlier burials took place in the previous period. The amount of Red Polished Ware is considerable, which might well indicate such a date.

TOMB 321 (Fig. 53: 1-4)

	SIZE			
	Length	Width	Depth	Height
Dromos	3.51	1.85	2.12	—
Stomion A	0.30	0.61	—	0.56
Chamber A	1.52	2.32	—	1.00
Stomion B	0.98	1.08	—	0.95
Chamber B	4.42	7.10	—	1.68

SHAPE

The dromos is large and regularly bucket-shaped with vertical long sides, a step at the semicircular end, and slightly sloping floor. Two chambers open from the dromos, a small one (A) from the middle of the long E. side, and the main chamber (B) from the short S.

side. The former is oval in shape with a small niche above the level of the floor at the S. end of the chamber. It was blocked by a single slab of local limestone, found slightly disturbed. The stomion is tunnel-shaped and slopes abruptly down to the horizontal floor. Roof and walls of the chamber form a flat vault.

The door stone of Chamber B was not *in situ* either. The stomion is wide and tunnel-shaped, and leads by means of a short step down to the chamber. Around the door is a rectangular moulding sunk into the face of the rock. The plan of the chamber is heart-shaped with a central projection in the back wall, which serves as a column to support the roof of this exceptionally large chamber (cf. the plan of Tomb 313 A). On the E. side of the column are two spacious niches, one about 0.35 m., and the other about 0.85 m. above the level of the floor. The other half of the chamber is provided with another large niche about 0.70 m. above the floor. All the niches have got low partitions cut in the rock along their edges. The chamber was very well preserved, and is in shape closely akin to Tomb 313 A. The series of niches has not, however, reached the same development as in that tomb, neither is the symmetry carried to the same perfection.

STRATIFICATION

The stratification showed that the filling had recently been dug through and replaced in the dromos. Only the N., semicircular end was intact. Chamber B was filled with dromos earth and mud, mixed with culture earth, heaps of potsherds and fragments of bones. The main chamber was almost empty. A layer of Red Polished potsherds covered by a stratum of silted clay, was found on the floor. In both chambers only a few bronze fragments were found, besides the potsherds. The tomb had, apparently, been excavated earlier.

CHRONOLOGY

The potsherds date the tomb to E. C. III.

TOMB 322 (Figs. 53: 5—7; 54—57; 58: 1; 59)

	SIZE			
	Length	Width	Depth	Height
Dromos	7.85	2.14	2.20	—
Stomion A	0.65	0.82	—	0.55
Chamber A.....	5.60	6.85	—	2.15
Stomion B	1.08	1.18	—	0.62
Chamber B.....	3.69	5.05	—	1.55
Stomion C	0.12	0.55	—	0.34
Chamber C.....	1.04	1.38	—	0.64
Stomion D I	0.24	0.75	—	0.61
Stomion D II	0.26	0.51	—	0.58
Chamber D	2.60	4.46	—	1.48
Stomion E	0.82	1.02	—	0.60
Chamber E.....	3.10	4.73	—	1.44

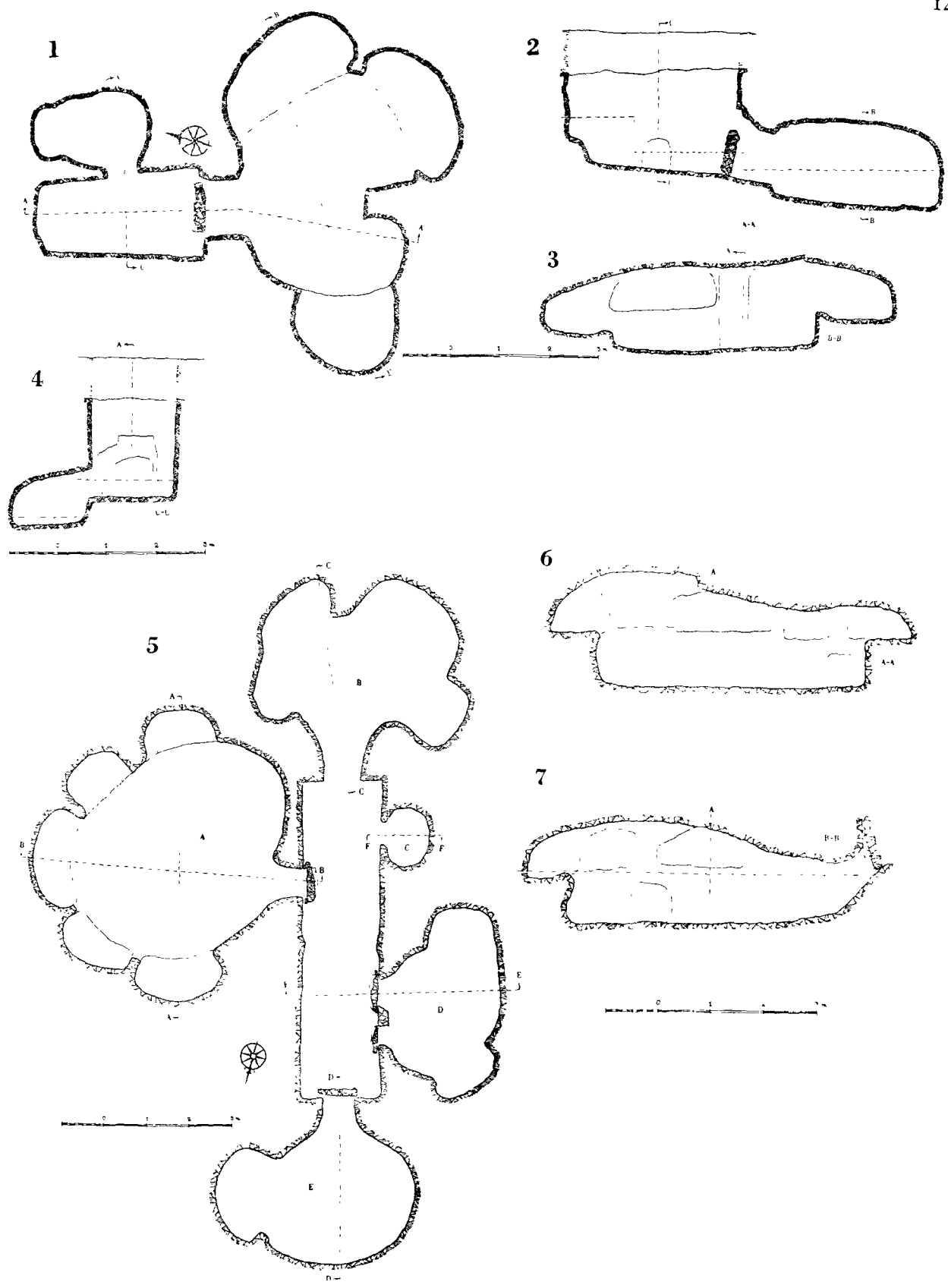

Fig. 53. Lapithos. Tomb 321, Plan (1); Sections A-A, B-B, C-C (2, 3, 4). Tomb 322, Plan (5); Sections A-A, B-B (6, 7).

SHAPE

This tomb should properly be considered as not one, but two tombs. The exceptional length of the dromos and the presence of five chambers can be explained by this fact. A narrow section in the middle of the dromos gives structural evidence for the connection of the two original dromoi, and marks the end of the earlier, and the beginning of the later one.

The S. end with the Chambers A, B and C is the earlier part, and the N. end with Chambers E and D is the later.

Several large blocks of heavy, calcareous limestone were found in the centre of the dromos, which have, evidently, been used for building a dividing wall between the two dromoi. They were found in disturbed positions. Both dromoi have perpendicular sides and horizontal floors.

Chamber A was closed by a single door stone, wedged with smaller stones; the stomion is a widening tunnel, which slopes steeply down to the horizontal floor. The plan of the chamber is very impressive. It is a regular oval, provided with five niches round the walls at about 1.00 m. above the floor. They were numbered from left to right 1—5. A sixth niche is cut at the floor-level between Niches 4 and 5 (No. 6). The roof is exceptionally high and the wide span, which was not supported by any "columns" (as Tomb 313 A and 321 B) has partly collapsed.

Chamber B is, too, of a very perfect type. It was blocked up by a large slab, which was, however, not *in situ*. The stomion is tunnel-shaped and descends in three steps to the horizontal floor. Opposite the entrance is a rock pillar as in Tomb 321, which divides the chamber into two halves. On each side of the central pillar is a large open recess at the floor-level, and a deep niche, raised about 0.40 m. above it. The whole construction is symmetrical.

Chamber C is a small, circular room with a steeply sloping entrance, a horizontal floor, and a curved roof.

Chamber D has, as mentioned above, two entrances. The S. one is the original. It was blocked by a door stone *in situ*, and the stomion leads down by two steps into the chamber. That the N. entrance is secondary is demonstrated by the different construction of the door-opening. Stomion D II opens right into the curved wall of the chamber, forming an acute angle with the bottom of the stomion. The chamber is an elongated oval with a niche at each short side, and a small shaft close to the S. niche. The floor is horizontal, and roof and walls form a flat vault.

Chamber E has a long, widening stomion sloping down to the horizontal floor of the chamber. It was closed by a heavy block of local limestone, wedged with smaller stones. The chamber is a large, regular oval, with a niche at the E. short side. The roof is unusually high, but of the usual type.

STRATIFICATION

As mentioned above some of the door stones were not found *in situ*. The tomb has been looted by robbers, who have even left a note of the date of the plundering. On the W. wall of the dromos about 1.00 m. below the surface was carved an inscription in the rock, reading:



Fig. 54. Lapithos. Tomb 322 A. Interior view with Niches 3, 4, 5, and 6.



Fig. 55. Lapithos. Tomb 322 B. The necklace (No. 14) *in situ*.

A. A. 1913. The earth, filling the dromos consisted of *chavara* mixed with clay and darker earth, and was disturbed almost all over the area, the result of the operations of the previous diggers.

Chamber A was, however, never entered. The door stone was removed, but the whole chamber was filled with debris, which obstructed further progress. The filling consisted of a thick layer of earth and clay, covering a stratum of *chavara*, fallen from the roof. The centre of the roof was pierced by a hole, caused by its collapse, which reached right up to the surface of the earth. Through this hole all the clay had fallen in.

The large chamber floor yielded remarkably few finds and the pottery was in a very bad state of preservation. It had been partly smashed by the heavy mass of rock debris, and partly dissolved by the damp. Close to Niche 6 a fine collection of bronze weapons was found, but the niche itself was empty. All the other niches contained deposits of various kinds but no remains of skeletons, except Niche 4 where some finger-bones were found, and close to these bones four rings of gold and silver. All the finds were made immediately on the rock floor of niches and chamber. Summing up the skeletal remains found scattered on the floor, the burials could be calculated at 4 or 5.

Chamber B had been entered and thoroughly sacked. A layer of clay, about 0.30 m. thick, covered the floor and contained a lot of broken Red Polished III pottery and also some bronzes and intact small pots. Below the W. niche, several bones of a horse skeleton* were found, and in association with these a great number of paste beads. Only one burial could be traced in the chamber. Its remains were found on the floor in the E. part. In the W. niche there may have been another, but the tomb-robbers had cleared it of its contents.

Chamber C was intact and very well preserved. Three pots were found directly on the floor, but no traces of burials could be found. Apparently it served only as a "dromos cupboard" in spite of its considerable size.

Chamber D was also intact and in a good state of preservation. It has, evidently, been

* The bones which were fairly well preserved have been studied and identified by Prof Hans Wallengren, Lund, who has kindly given us detailed information

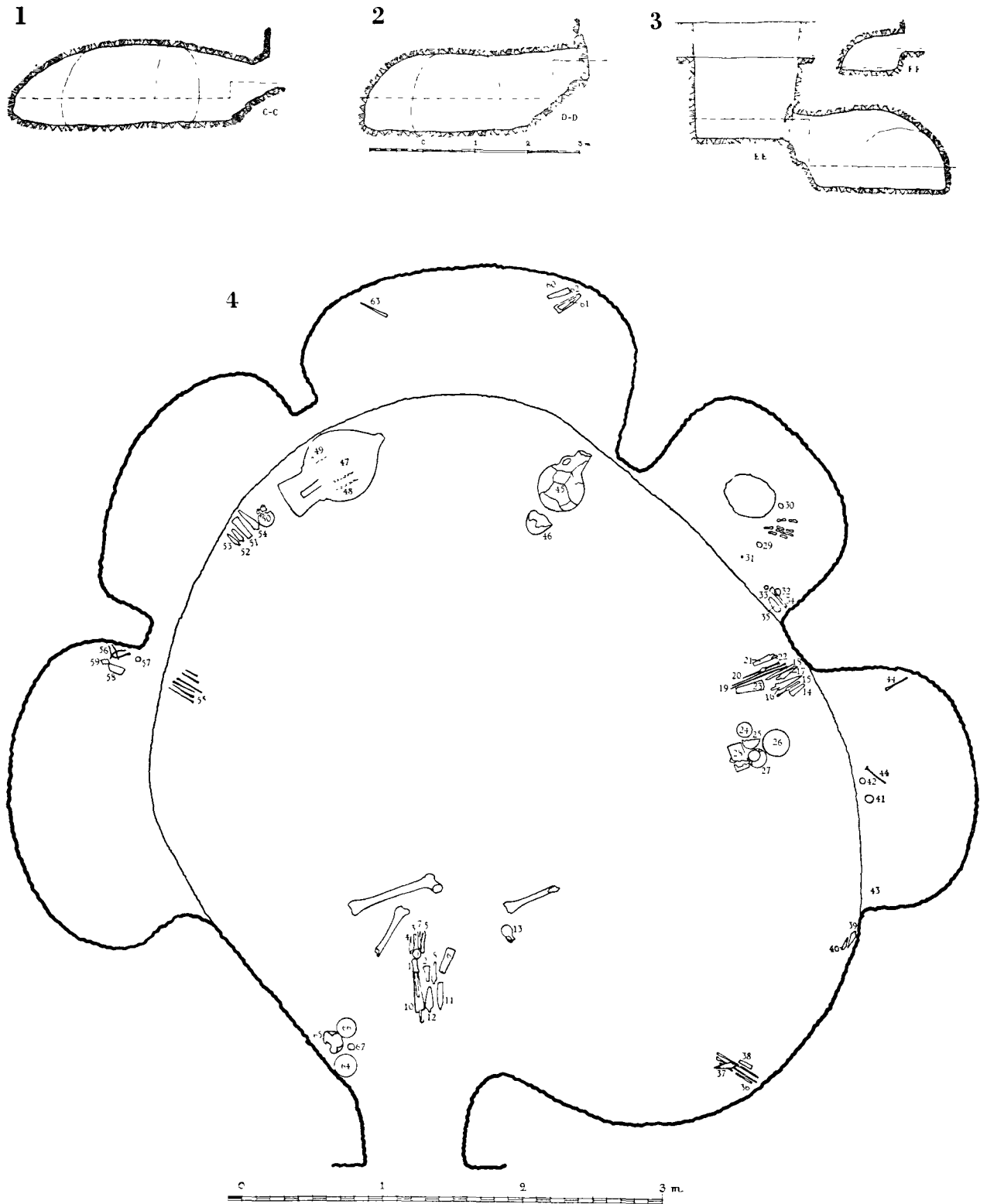

Fig. 56. Lapithos. Tomb 322, Sections C-C, D-D, E-E, F-F (1, 2, 3); Chamber A, Finds *in situ* (4).

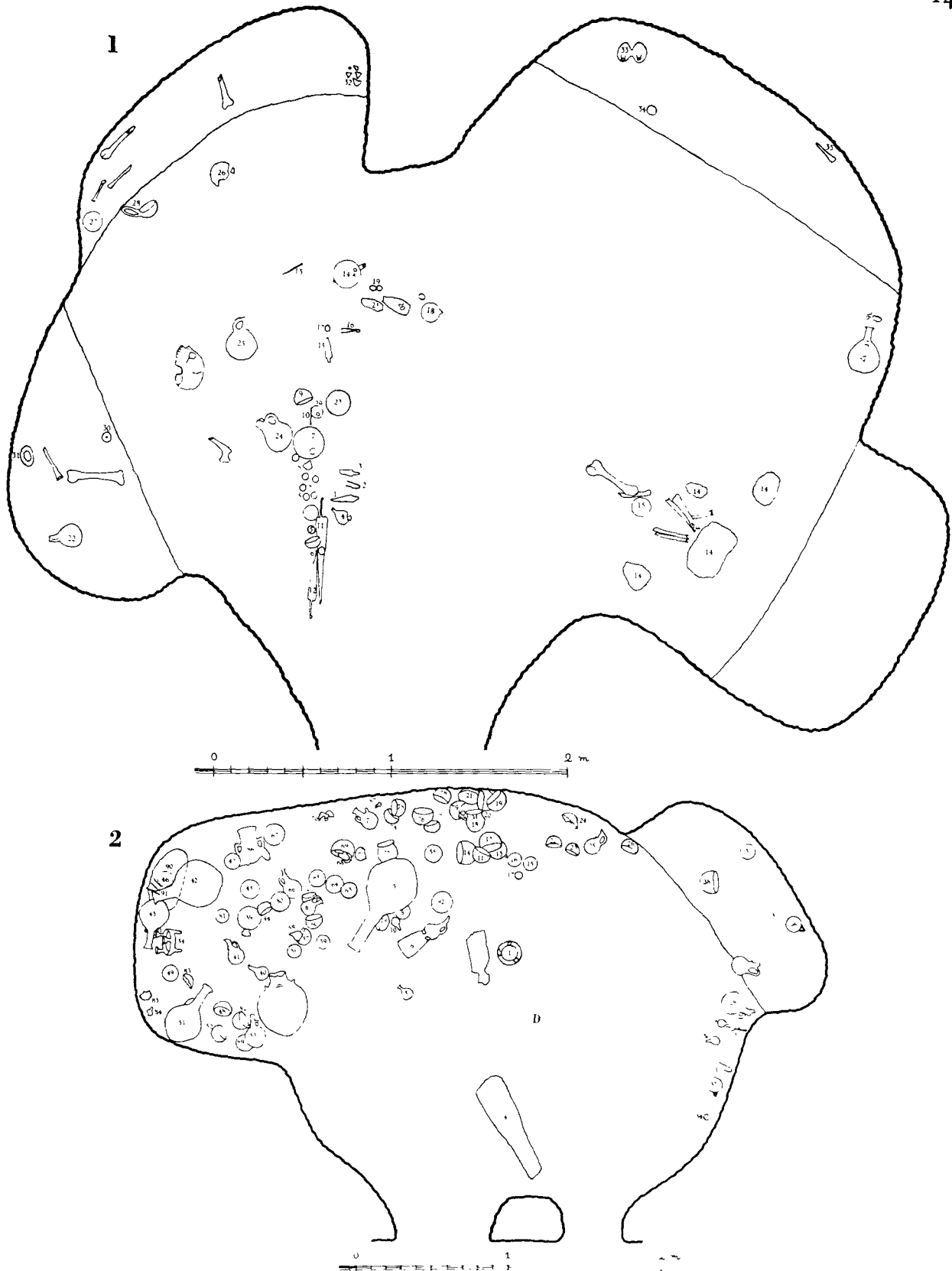

Fig. 57. Lapithos. Tomb 322, Chambers B and D, Finds *in situ* (1, 2).

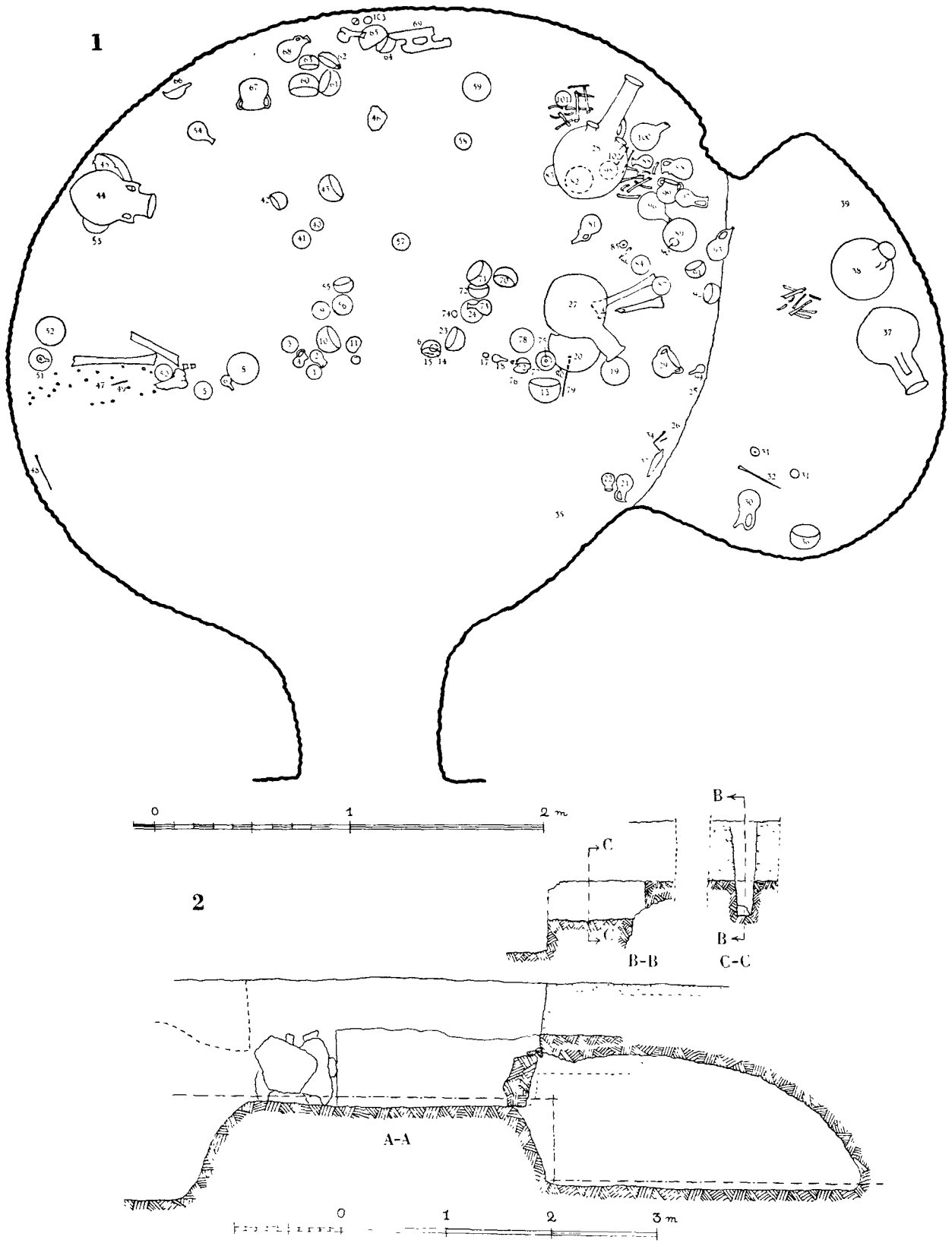

Fig. 58. Lapithos. Tomb 322 E, Finds *in situ* (1). Tomb 323, Sections A-A, B-B, C-C (2).

used in two periods. The earlier epoch, associated with the opening of Stomion D I and the building of the chamber, was represented mainly by a large quantity of Red Polished II and III potsherds found on the floor in all parts of the chamber. Its skeletal material had disappeared. The second period comprises, as far as evidence goes, the bulk of the intact pottery. Only tiny fragments of a human skeleton were found in and below the S. niche. Near the centre of the back wall, lay an almost complete skeleton of a dog.

The small shaft in the S. niche contained a Red Polished II bowl and some paste beads, which might be assigned to the earlier period and placed in their present position, when the chamber was cleared for secondary burials. The finds of the later period all lay directly on the floor, or on the fragments of the tomb-gifts of the earlier burials. Some of the well preserved pots may have belonged to the first group and have escaped destruction, when the chamber was reused. A minute distribution can not therefore be practically carried out.

Chamber E also must be considered as a unit. All its finds lay on the floor and were covered by a deep layer of pulverized *chavara* debris, fallen from the roof. Four burials could be traced in the chamber: one in the niche, a second below the niche on the floor, a third in the centre of the chamber, and a fourth in the W. side. Many remains of animal bones were also found here and there on the floor. A large piece of a bull's femur lay near the back wall, together with many paste beads.

BURIALS

In all the chambers the preservation of the skeletal material was very bad, and any statement regarding the original position of the dead bodies is a matter of conjecture.

Splendid funeral ceremonies must, surely, have taken place in connection with many of the burials. The great quantity of animal bones (horse and bull) in Chamber B and E, the fine collection of cult vessels, the fetish-stone and the marble idol, Nos. 4 and 2 — the latter unfortunately lost in the store house — in Chamber D, bear eloquent witness of the cult of the deceased. The presence of gold and the many bronzes in Chamber A, as well as the magnificent construction of Chambers A and B give evidence of the wealth of the burials.

FINDS (GROUPS: PLS. XXXV—XXXVIII; TYPES: L. OF PL. II)

Chamber A

- | | |
|---|---|
| <ol style="list-style-type: none"> 1. Bronze chisel with lozenge-shaped section and curved edge, fixed into a solid handle of horn. Length 25.4. Floor. 2. Triangular axe of bronze with wide, curved edge. Length 12.0. Floor. 3. Bronze chisel with one pointed end, curved edge, and rectangular section. Traces of the wooden handle on tang. Length 11.2. Floor. 4. Pointed awl of bronze with rectangular section and tapering, pointed tang. Length 10.8. Floor. 5. Bronze tweezer with flat arms tapering downwards, and loop-shaped top. Length 12.9. Floor. 6. Axe of bronze with tapering end, pierced by a hole, and widening, curved edge. Piece of the end missing. Length 18.9. Floor. | <ol style="list-style-type: none"> 7. Bronze tweezer as No. 5. Broken into seven pieces. Length 9.6. Floor. 8. Flat bronze scraper with flat end, concave sides, low midrib, and flat, narrow tang with one rivet. Length 14.0. Floor. 9. Spiral of flat wire, probably made of a mixture of bronze and silver. Much damaged. Floor. 10. Bronze sword. Much damaged. Floor. 11. Leaf-shaped bronze knife with two edges, pointed end, midrib, and straight sides. Upper part and tang missing. Length 18.9. Floor. 12. Bronze knife as No. 11, but with rounded shoulders, and flat, tapering tang; two rivet-holes. Upper part of tang missing. Length 15.6. Floor. 13. Red Polished II pear-shaped jug with round base, taper- |
|---|---|

- ing neck, wide funnel-rim, and handle from rim to shoulder. Chess-board patterns around neck, and a vertically arranged design of hatched zigzag bands and ladder-patterns on body. Height 11.5. Floor.
14. Bronze axe with straight sides, tapering end, and curved edge. Length 12.2. Floor.
 15. Straight bronze pin with small, flat head, and an oval disc at the middle. The pointed end missing. Length 19.9. Floor.
 16. Leaf-shaped bronze knife with slightly curved sides, midrib, rounded end, two edges, and flat, narrow tang with one rivet at top. Length 24.3. Floor.
 17. Leaf-shaped bronze knife with midrib, two edges, slightly curved sides, rounded point, and flat, small tang with round top; three rivets. Length 18.6. Floor.
 18. Bronze chisel with sides widening upwards, tapering tang, curved edge, and rectangular section. Length 23.4. Floor.
 19. Two straight bronze pins with pointed ends and small button-heads. Length 40.8 and 40.2. Floor.
 20. Straight bronze pin with pointed end, small button-head, and an oval disc at the middle. Length 28.3. Floor.
 21. Oblong bronze scraper with rounded end, low midrib, straight sides, and square, flat tang with one rivet. Length 14.5. Floor.
 22. Straight, tapering bronze awl with pointed end, square section, and narrow, solid tang. Length 15.8. Floor.
 23. Bronze axe with straight sides, curved edge, and a hole at the upper end. Length 20.4. Floor.
 24. Red Polished III hemispherical bowl with a string-hole projection at rim. Mat surface. Diam. 8.5. Floor.
 25. Red Polished III hemispherical bowl with two knobbed string-hole projections, and two broad knobs on rim. Herring-bone patterns around rim, and two friezes of parallel zigzag lines around body. Hatchings on the projections. Diam. 13.0. Floor.
 26. Red Polished III shallow bowl with round base. Very coarse ware; rim chipped. Diam. 13.2. Floor.
 27. Red Polished III globular cooking-pot with round base, splaying rim, and two handles from rim to body. Height 8.5. Floor.
 28. Fragments of a Red Polished plank-shaped idol. Floor.
 29. Gold spiral of flat wire. Diam. 2.0. Floor.
 30. Gold spiral as No. 29. Diam. 2.0. Floor.
 31. Gold spiral as No. 29. Diam. 2.0. Floor.
 32. Lump of iron. Length 4.2. Floor.
 33. Silver* spiral as No. 29. Diam. 1.7. Floor.
 34. Bronze tweezer with flat arms, and loop-shaped top. One arm broken. Length 17.4. Floor.
 35. Oblong bronze scraper with concave sides, rounded point, and two rivets at start of tang. Tang missing. Length 12.8. Floor.
 36. Two straight bronze pins with pointed ends, and small flattened heads; fragments of a third. Length 34.1; 33.8. Floor.
 37. Leaf-shaped bronze knife with straight sides, two edges, midrib, pointed end, and flat, narrow tang. Three rivets. Length 17.5. Floor.
 38. A very thin bronze sheet wound into a cylindrical shape, and at the upper end kept together with a flat wire. Probably a mounting of a wooden handle of a sword. Length 9.0. Floor.
 39. Leaf-shaped bronze knife with slightly concave sides, two edges, pointed end, midrib, and flat tang. Three rivets. Top of tang missing. Length 13.7. Floor.
 40. Small bronze knife with concave sides, two edges, low midrib, and short, flat tang with one rivet. Length 8.3. Floor.
 41. Fragments of a Black Polished incised jug. Height c. 5.1. Floor.
 42. Red Polished biconical, incised spindle-whirl. Diam. 3.0. Floor.
 43. Ten spherical beads of white paste. Diam. varying from 0.9 to 1.6. Floor.
 44. Long, straight pin with pointed end, and a flat button-head. Slightly bent. Length 16.8.
Straight pin with thickening, flattened head, and a flat wire wound around the lower part. Pointed end missing. Length 12.0. Floor.
 45. Red Polished II large, globular jug with round base, convex, tapering neck, and handle from neck to shoulder. Much damaged. Floor.
 46. Fragments of a similar Red Polished III jug. Floor.
 47. Red Polished II large, globular jar with flat base-knob, somewhat concave neck, a ridge between neck and shoulder, and two angular handles from neck to shoulder. Height 82.5. Floor.
 48. Two straight bronze pins with pointed ends and widening heads. Length 21.8; 22.25. Floor.
 49. Red Polished III globular jug with round base; cylindrical, backwards-curved neck, beaked mouth, handle from rim to shoulder, and a projection opposite the handle. Mat surface. Height 17.5. Floor.
 50. Fragments of a Red Polished III jug, similar to No. 49. Floor.
 51. Bronze axe with straight sides, tapering end, and curved edge. Length 17.0. Floor.
 52. Rectangular bronze scraper with straight sides, and short, narrow tang with one rivet. Length 11.7. Floor.
 53. Narrow bronze knife with concave sides, two edges, midrib, and flat, narrow tang. Two rivets. Pointed end missing. Length 12.9. Floor.
 54. Bronze knife with concave sides, two edges, midrib, and short tang pierced by two rivet-holes. Pointed end missing. Length 18.3. Floor.
 55. Bronze fragments.
Small bar with rectangular section. Length 9.7.
Upper part of a large pin with flat button-head. Traces of silver here and there. Length 17.2.
Central part of pin with an oval disc in the centre. Length 17.8.
Pin with pointed end and thickening head. Length 19.7.

* Analysed by the Government's analyst Dr. Willimott, Nicosia, Cyprus.

- Upper part of large pin with flat button-head. Length 19.7.
 Upper part of pin with thickening head. Length 14.0. Floor.
56. Needle with pointed end and eyelet at top. Eyelet broken. Length c. 16.0.
 Straight pin with pointed end and thickening head. Length c. 16.5.
 Straight pin with pointed end and thickening, flattened head. Length c. 20.4. Floor.
57. Red Polished incised, conical spindle-whirl. Diam. 3.5. Floor.
58. Trapezoid whetstone of grey, heavy stone. Length 12.0. Floor.
59. Rectangular, thin whetstone of white stone, pierced by a hole at the top. Length 5.2. Floor.
60. Bronze axe with somewhat convex sides and edge. Length 16.8. Floor.
61. Bronze axe with straight sides, tapering end, and curved, fan-shaped edge. Length 16.8. Floor.
62. Bronze axe with straight sides and tapering end, pierced by a hole. Length 19.6. Floor.
63. Bronze awl with pointed end and rectangular section. Length 19.3. Floor.
64. Fragments of a Red Polished III deep bowl, similar to No. 24. Floor.
65. Red Polished III bowl as No. 24. Diam. 15.9. Floor.
66. Fragment of a Red Polished III bowl, similar to No. 24. Floor.
67. Red Polished incised, conical spindle-whirl. Diam. 3.9. Floor.
10. Thin, straight bronze needle with pointed end, and an eyelet at the top. Damaged. Length 9.7. Floor.
11. Triangular bronze sword with straight sides, pointed end, two edges, midrib, narrow cuttings near the tang, and hooked, solid tang. Leather-windings still traceable on tang. Length 58.6. Floor.
12. Bronze dagger as No. 11. Length 39.0. Floor.
13. Straight pin of silver-lead. Ends missing. Length 11.4. Floor.
14. Large necklace of white, spherical paste beads of varying size, rhythmically arranged in series of symmetrical composition. Floor.
- 14 A) Red Polished II hemispherical bowl with a tubular spout; a small, vertical handle on spout; string-hole projection opposite the spout. Diam. 16.3. Floor.
15. Leaf-shaped bronze knife with straight sides, pointed end, two edges, midrib, and flat, narrow tang. Three rivets. Length 14.0. Floor.
16. Bronze tweezer with narrow, loop-shaped top. Length 11.1. Floor.
17. Double spiral ring of thin silver-lead. Broken into two pieces. Diam. 2.7. Floor.
18. Red Polished III shallow bowl with open spout, and a string-hole projection opposite the spout. Diam. 10.7. Floor.
19. Three conical spindle-whirls of Red Polished Ware. Diam. 4.1; 3.9; 3.5. Floor.
20. Red Polished III incised, sack-shaped bottle with flat base. Body covered with vertical bands, filled with hatched squares, lozenges and triangles, flanking plain lozenges. Paint worn; neck and handle missing. Height 16.5. Floor.
21. Whetstone of irregular shape. Length 14.5. Floor.
22. Red Polished II incised, pear-shaped jug with round base, tapering neck, and handle from neck to shoulder. Horizontal bands of parallel lines, interrupted by vertical zigzag lines around neck; body covered with the usual skeuomorphic design of concentric circles, connected by oblique and horizontal bands of parallel lines. Upper part of neck missing. Surface worn. Height 15.5. Floor.
23. Red Polished II bowl as No. 9. Rim chipped; repaired. Diam. 13.6. Floor.
24. Red Polished III globular jug with round base; cylindrical cut-away neck, and handle from neck to shoulder. Height 23.0. Floor.
25. Red Polished III globular jug with round base, backwards-curved neck, beaked mouth, and handle from rim to shoulder. Height 21.9. Floor.
26. Red Polished II bowl as No. 9. Fragmentary. Floor.
27. Red Polished II bowl as No. 9; rim chipped. Diam. 12.3. Floor.
28. Red Polished III shallow bowl with round base, and a very high, vertical handle from rim to body. Diam. 8.6. Floor.
29. Red Polished II globular bottle with round base, tapering neck, and straight rim, pierced by two holes. Two

Chamber B

1. Leaf-shaped bronze knife with slightly curved sides, rounded end, two edges, midrib, and flat, narrow tang. Two rivet holes. Top of tang missing. The shape of the wooden handle can be traced. Length 16.4. Floor.
2. Bronze tweezer with rounded top. Length 8.8. Floor.
3. Oval bronze scraper with two edges, rounded end, and flat, narrow tang with one rivet. Chipped. Length 9.5. Floor.
4. Fragments of a Red Polished III miniature jug. Floor.
5. Ten spindle-whirls of Red Polished and Black Polished Wares. Diam. 3.5—5.5. Floor.
6. Red Polished II hemispherical bowl with a string-hole projection at rim. A band of horizontal lines, crossed by parallel zigzags around rim, and a hatched zigzag band around body. Paint worn. Diam. 8.0. Floor.
7. Red Polished III shallow bowl with round base; upright-standing, vertical handle below rim, a small projection on rim, and an open spout opposite the handle. Handle and spout missing. Diam. 18.4. Floor.
8. Black Polished hemispherical bowl with a string-hole projection at rim. A band, partly filled with parallel, oblique lines around rim, and a band of hatched lozenges around body. Diam. 8.0. Floor.
9. Red Polished II bowl as No. 8. Diam. 10.6. Floor.

- bands around neck, filled with antithetic chevrons separated by hatched bands; body covered with vertical bands of the same ornament, alternating with bands, filled with hatched triangles. Height 9.5. Floor.
30. Red Polished spindle-whirl as No. 19. Diam. 5.2. Floor.
 31. Red Polished III incised ovoid pyxis with round base, oval mouth, and an oval cover, pierced by four holes, to match two equally pierced knobs below the rim. Body covered with the usual skeuomorphic design of concentric circles, connected with bands of parallel lines, running in oblique and horizontal direction. Cover decorated with bands of parallel lines and antithetic, concentric semicircles. Length 15.0. Floor.
 32. Fragments of cult vessel of Red Polished III Ware. Floor.
 33. Red Polished III coupled vessel consisting of two bird-shaped vases with two legs each. Each vase has tapering neck and splaying rim. A network of herring-bone pattern and short strokes over the bodies suggest feathers. A string-hole projection below each neck. One rim, one projection and two legs missing. Paint worn. Height 21.9. Floor.
 34. Red Polished biconical spindle-whirl, decorated as No. 19. Diam. 5.5. Floor.
 35. Fragments of a bronze tweezer as No. 16. Length 12.2. Floor.
 36. Flat, rectangular, miniature idol of terracotta with flat head, and small projections on the shoulders, indicating the beginnings of the arms. Bands around hair, two dots for eyes, a vertical line for nose; no mouth; hair-plaits falling in zigzags on the back; necklace and girdled robe as usual, and sleeves indicated by two oblique lines, ending in dots. Not complete. Length 4.0. Floor.
 37. Red Polished II incised jug as No. 22, but with funnel-rim, handle from rim to shoulder, and small filling ornaments on the body. Height 27.0. Floor.

C h a m b e r C

1. Red Polished III hemispherical bowl with a string-hole projection at rim. Double zigzag bands around rim; concentric semicircles, and vertical lines around body. Diam. 11.2. Floor.
2. Fragments of an incised Red Polished II jug. Floor.
3. Red Polished II pear-shaped jug, with round base; narrow, tapering neck, funnel-rim, and handle from rim to shoulder. Encircling bands of parallel lines around neck; concentric circles, and oblique and horizontal bands of parallel lines around body. Height 8.9. Floor.

C h a m b e r D

1. Red Polished III ring-vase with three solid legs, surmounted by three hemispherical bowls, all with spouts and string-hole projections. A frieze of hatched lozenges around the ring; radiating elements of herring-bone pattern, zigzag lines, straight lines, hatched lozenges, oblique lines, and ornaments suggesting twigs on upper part of ring. Horizontal lines on the legs. Height 20.3. Floor.
2. Fragments of a large, plank-shaped idol of local marble. Floor.
3. Red Polished II globular jug with round base; tall, tapering neck, splaying rim, and handle from neck to shoulder; handle missing. Paint worn. Height 67.2. Floor.
4. Oblong menhir of local stone, tapering at one end. Length 70.4. Floor.
5. Red Polished II small, pear-shaped jug with tapering neck, round base, wide funnel-rim, and handle from rim to shoulder. Height 10.5. Floor.
6. Red Polished III cult vase composed of one pear-shaped jug with cylindrical neck, beaked mouth, and handle from rim to shoulder, placed on top of a sack-shaped vase with flat base. Between the vases are four hemispherical bowls placed symmetrically. Two of the bowls missing. Upper vase decorated with bands of parallel lines around neck; vertical bands, filled with ladder-patterns, and parallel zigzag elements on body; hatchings on handle. The bowls are covered with hatched lozenges and small, punctured filling ornaments, one with a broad border around rim, one without. The bottom vase is divided into two fields by a broad band of horizontal lines around belly, and both fields are decorated with vertical bands of the same sort as those of the upper vase. Height 38.1. Floor.
7. Red Polished III vase of a composition similar to that of No. 6. The lower vase is a globular jug with round base, concave neck, and handle from neck to shoulder. Both vases decorated with bands of horizontal lines around the necks, and broad bands of parallel zigzag lines on the bodies. Damaged. Height 40.3. Floor.
8. Red Polished II hemispherical bowl with a string-hole projection at rim. Diam. 10.4. Floor.
9. Red Polished II bowl as No. 8; projection missing. Diam. 10.5. Floor.
10. Red Polished III pear-shaped bottle with round base; tapering, cut-away neck, and a small vertical handle on neck. A chess-board pattern of short horizontal lines on neck; hatched encircling bands around shoulder and base, and vertical, punctured and hatched lines on the body. Piece of mouth missing. Height 8.7. Floor.
11. Red Polished II hemispherical bowl with a string-hole projection at rim. Diam. 11.9. Floor.
12. Red Polished II bowl as No. 8. Rim chipped. Diam. 14.0. Floor.
13. Red Polished III shallow bowl with round base, and an elevated handle from rim to body. Piece of handle missing. Mat surface. Diam. 12.1. Floor.
14. Red Polished II bowl as No. 8. Rim chipped. Diam. 14.0. Floor.
15. Red Polished III bowl, mainly as No. 8, but shallower. Even red. Diam. 8.4. Floor.
16. Red Polished II bowl as No. 8. Rim chipped. Diam. 9.4. Floor.
17. Red Polished incised, conical spindle-whirl. Diam. 5.2. Floor.

18. Red polished III globular cooking-pot with round base, splaying rim, handle from rim to shoulder, and a hooked projection at rim opposite the handle. Height 13.0. Floor.
19. Red Polished II bowl as No. 8. Diam. 12.0. Floor.
20. Red Polished II bowl as No. 8. Rim chipped. Diam. 13.6. Floor.
21. Red Polished II bowl as No. 8. Diam. 14.2. Floor.
22. Red Polished III hemispherical bowl. A band filled with oblique lines around the rim, and four hatched bands from rim to base with concentric circles in the angular interstices. Paint obliterated. Diam. 11.0. Floor.
23. Red Polished III bowl as No. 11. Diam. 9.5. Floor.
24. Red Polished III bowl as No. 11. Chipped. Diam. 14.4. Floor.
25. Red Polished III globular jug with round base, concave neck, beaked mouth, handle from rim to shoulder, and a string-hole projection opposite the handle. Dark surface. Height 15.5. Floor.
26. Red Polished III bowl as No. 11. Diam. 11.1. Floor.
27. Red Polished III pear-shaped jug with round base; concave, cut-away neck; oblique, splaying rim, and an elevated handle from neck to shoulder. A string-hole projection between neck and shoulder opposite the handle. Zigzag incisions and dots on neck. Height 17.2. Floor.
28. Red Polished III jug as No. 25, but with slightly thicker neck. Height 12.3. Floor.
29. Black Polished globular jug with round base, and tall, tapering neck. Encircling lines around neck, shoulder and base, and a zigzag band around body. Height 9.0. Floor.
30. Black Polished jug as No. 29, but with handle from neck to shoulder. Decoration worn. Height 8.8. Floor.
31. Straight bronze pin with pointed end, and thickening, flattened head. Broken into two pieces. Length 20.3. Floor.
32. Leaf-shaped bronze knife with straight sides, two edges, rounded end and top, and two rivets through top. Length 12.4. Floor.
33. White Painted II shallow bowl with round base, inwards-bent rim, and a horizontal handle at rim. A frieze of parallel, oblique lines around rim. a cross of bands of parallel lines outside the bottom; wavy lines and a black line on handle. Diam. 9.1. Floor.
34. Red Polished spindle-whirl as No. 17. Diam. 4.2. Floor.
35. Red Polished II bowl as No. 8. Rim chipped. Diam. 9.8. Floor.
36. White Painted II bowl as No. 33. Hatched triangles around rim; a cross of broad stripes, forming a chess-board pattern outside the bottom; bands of parallel lines and wavy lines, radiating from an encircled dot inside the bottom, and a black line on handle. Diam. 10.5. Floor.
37. Fragments of a thin, cylindrically wound bronze sheet. Floor.
38. Red Polished III bowl, mainly as No. 8, but deeper. Even red. Diam. 14.4. Floor.
39. Red Polished II incised, pear-shaped jug with round base; tapering neck, wide funnel-rim, and handle from rim to shoulder. Bands of parallel lines around neck; body covered with the usual skeuomorphic design of concentric circles connected with bands of parallel lines, running obliquely and horizontally. Hooked chevrons as filling ornaments. Height 26.8. Floor.
40. Red Polished II jug as No. 39, but without filling ornaments. Rim and handle missing. Height 13.6. Floor.
41. White Painted II pear-shaped jug with round base, cylindrical neck, beaked mouth, handle from neck to shoulder, and a string-hole projection opposite the handle. Bands of horizontal lines around neck; a cross, encircled by wavy lines, on base; body covered with broad, vertical, hatched bands and vertical, wavy lines. A wavy line on handle. Height 19.5. Floor.
42. Red Polished III globular jug with round base, tapering neck, splaying rim, and handle from neck to shoulder. Height 49.5. Floor.
43. Red Polished II globular jug with round base; cylindrical neck; splaying rim, handle from neck to shoulder, and a string-hole projection opposite the handle. Height 31.3. Floor.
44. Red Polished II bowl as No. 8. Diam. 10.3. Floor.
45. Red Polished III bowl as No. 8. Herring-bone patterns around rim, and two friezes of hatched lozenges around the body with small filling ornament suggesting branches. Diam. 11.3. Floor.
46. Red Polished II bowl as No. 8, decorated with two friezes of parallel zigzag lines around rim and body. Damaged. Floor.
47. Red Polished II bowl as No. 8. Diam. 10.0. Floor.
48. Red Polished II bowl as No. 8. Diam. 10.6. Floor.
49. Red Polished III hemispherical bowl with a small, flat knob below rim. Diam. 10.1. Floor.
50. Red Polished II bowl as No. 8. Horizontal bands of parallel lines around rim, and an encircled cross outside the base; concentric semicircles, alternating with hatched squares, around body. Diam. 11.0. Floor.
51. Red Polished II jug as No. 43, but without string-hole projection. Rim chipped. Height 44.7. Floor.
52. Red Polished III globular hydria with round base; wide, cylindrical neck, flat rim, two knobbed handles from neck to shoulder, and two horizontal, square handles on shoulder. Relief decoration on neck and shoulder. Height 43.1. Floor.
53. Red Polished III jug mainly as No. 43, but with funnel-rim, and angular handle. Height 22.5. Floor.
54. Mixed Red Polished III and White Painted I ring-vase. A hollow ring with three legs, symmetrically surmounted by three, small conical bowls fixed on high, hollow stems. Parallel zigzag lines around ring; parallel, oblique lines on ring, and horizontal lines on the stems (Red Polished III). The bowls are decorated with vertical straight and wavy lines and dots (White Painted I). One leg missing; one bowl chipped. Height 17.4. Floor.
55. Red Polished III bowl as No. 8. Rim chipped. Diam. 11.2. Floor.
56. Red Polished II bowl as No. 11. Surface worn. Diam. 8.7. Floor.

57. Red Polished III bowl as No. 11. Diam. 10.5. Floor.
58. Red Polished II jug as No. 29. Height 8.5. Found inside No. 57.
59. Red Polished III bowl as No. 11. Diam. 9.2. Floor.
60. Red Polished II bowl as No. 50. Horizontal bands of parallel lines around rim; body covered with an irregular design of short, horizontal lines, arranged in vertical bands and zigzags. Diam. 11.2. Floor.
61. Red Polished II jug as No. 39. Partly broken; surface worn. Height 14.7. Floor.
62. Red Polished III bowl as No. 11. Hatched lozenges around rim and base. Diam. 10.0. Floor.
63. Red Polished II bowl as No. 8. Rim chipped. Diam. 9.6. Floor.
64. Red Polished II bowl as No. 8. Herring-bone pattern around rim, and broad, vertical bands of parallel lines with hooked chevrons in the angular interstices on body. Diam. 10.7. Floor.
65. Red Polished II bowl as No. 8. Diam. 11.5. Floor.
66. Red Polished III globular jug with round base; cylindrical cut-away neck, and handle from neck to shoulder. Rim chipped. Height 19.6. Floor.
67. Red Polished II bowl as No. 8. Diam. 14.4. Floor.
68. Red Polished II bowl as No. 8. Damaged. Found inside No. 69.
69. Red Polished II bowl as No. 8. Diam. 14.6. Floor.
70. Red Polished II bowl as No. 8. Damaged. Floor.
71. Red Polished II bowl as No. 50. A narrow herring-bone border around rim, and two friezes of hatched lozenges around body. Damaged. Floor.
72. Red Polished III cooking-pot as No. 18. Height 14.3. Floor.
73. Red Polished III pear-shaped jug with round base, tapering neck, splaying rim, handle from neck to shoulder, and a tubular spout opposite the handle. Spout broken. Height 17.2. Floor.
74. Red Polished II bowl as No. 8. Bands of horizontal lines around rim, and a frieze of hatched lozenges with punctured, vertical lines as filling ornaments around body. Diam. 10.8. Floor.
75. Red Polished III bowl as No. 11. Diam. 10.0. Floor.
76. Red Polished III bowl as No. 11. Diam. 12.1. Floor.
77. Red Polished II bowl as No. 8. Diam. 9.6. Floor.
78. Red Polished II bowl as No. 8. Rim chipped. Diam. 11.6. Floor.
79. Red Polished II bowl as No. 8. Diam. 13.6. Floor.
80. Red Polished II bowl as No. 8. Diam. 13.6. Floor.
81. Red Polished II bowl as No. 8. Diam. 9.6. Floor.
82. Red Polished III bowl as No. 11. Diam. 11.0. Floor.
83. Red Polished II bowl as No. 8. A band of horizontal lines around rim, and a zigzag band of parallel lines around the body. Damaged. Floor.
84. Fragments of a Red Polished III jug as No. 29. Floor.
85. Fragments of a Red Polished II bowl as No. 8. Floor.
86. White Painted II pear-shaped amphora with round base; cylindrical neck, flat rim, and two handles from neck to shoulder. A network frieze below rim and around shoulder; parallel zigzags above handles; crossed zigzags around lower part of neck, on rim, between handles, and around belly; red polished base, and transverse lines on the handles. Height 35.2. Floor.
87. Fragments of thin, cylindrical bronze sheet. Floor.
88. Red Polished incised, conical spindle-whirl. Diam. 3.3. Floor.
89. Red Polished II bowl as No. 8. A thin herring-bone border around rim; body covered with a rich design of concentric semicircles; hooked, oblique lines; hatched squares, lozenges, and punctured lines. Diam. 11.2. Floor.
90. 12 beads of white paste varying in diam. between 1.25 and 1.5. Floor.
91. Three small bronze pins with pointed ends and rounded heads. Length 7.5; 9.6; 10.5. Floor.
92. Red Polished II bowl as No. 8. Diam. 15.5. Floor.
93. Red Polished II globular amphora with round base, tapering neck, flattened rim, and two angular handles from neck to shoulder. Button-ornaments in relief on neck and shoulder. Damaged (Suppl.) Floor.
94. Red Polished III incised hemispherical bowl with curved spout, wide rim, and a profiled projection at rim opposite the spout. A herring-bone pattern around rim; bands of parallel lines around spout, and a broad band of parallel zigzag lines with hatched lozenges in the angular interstices. At base of bowl is an excrescence which suggests that the bowl was fixed on a ring-vase. Even red. Damaged (Suppl.) Floor.
95. Red Polished III jug as No. 66. Damaged. (Suppl.)
96. Red Polished III jug as No. 42. Damaged. (Suppl.)

C h a m b e r E

1. Black Polished pear-shaped jug with flattened base, narrow neck, and handle from rim to shoulder. Horizontal lines around neck, and circular bands connected with vertical stripes of oblong chess-board patterns on body. Rim missing. Height 10.0. Floor.
2. Red Polished III globular jug with round base, wide neck, straight rim, and a slightly elevated, knobbed handle from rim to shoulder. Friezes of parallel zigzag lines, separated by horizontal lines, around rim, neck, shoulder, and belly. Height 10.0. Floor.
3. Red Polished III deep bowl with round base, splaying rim, and a small projection opposite the handle. Handle and rim broken. Height 7.8. Floor.
4. Black Polished jug as No. 2, but with plain handle. A hatched zigzag band around neck, horizontal lines around shoulder, and oblong chess-board patterns in a band around belly. Height 7.1. Floor.
5. Red Polished III hemispherical bowl with a string-hole projection at rim. Mat surface. Even red. Diam. 9.4. Floor.
6. Black Polished pear-shaped bottle with round base, narrow, cylindrical neck, straight rim, and a string-hole handle at rim. Bands of horizontal lines around neck; body covered with a vertically arranged pattern of hatched lozenges, hatched bands, and concentric circles. Height 8.4. Floor.

7. Red Polished depressed, spherical spindle-whirl with flat base and top. Diam. 4.75. Floor.
8. Red Polished III bowl as No. 5. A band of parallel zigzag lines around rim; body covered with a design of hatched, vertical bands from rim to base, hatched triangles, and concentric lozenges. Rim chipped. Diam. 16.4. Floor.
9. Red Polished III bowl as No. 5. Diam. 9.5. Floor.
10. Red Polished III hemispherical bowl with a string-hole projection at the rim. Black rim and inside. Diam. 12.8. Floor.
11. Red Polished II hemispherical bowl with a string-hole projection at rim. Diam. 8.0. Floor.
12. Fragments of a Black Polished hemispherical bowl with horizontal bands of parallel lines below rim, and two friezes of concentric semicircles, alternating with oblique ladder-pattern elements. Floor.
13. Red Polished II bowl as No. 11. Diam. 15.4. Floor.
14. Red Polished incised, slightly biconical spindle-whirl. Diam. 4.7. Floor.
15. Fragments of one thick and one thin bronze pin. Floor.
16. Red Polished II bowl as No. 11. Diam. 10.4. Floor.
17. Red Polished spindle-whirl as No. 14. Diam. 4.9. Floor.
18. Black Polished bottle as No. 6. Bands of horizontal lines around neck; body covered with a vertically arranged design of zigzag bands, punctured lines, and concentric circles. Height 8.3. Floor.
19. Red Polished II bowl as No. 11. Pieces of rim missing. Diam. 14.7. Floor.
20. Red Polished III wide, shallow bowl with a small, vertical handle below rim, and an open spout opposite the handle. Spout missing. Diam. 27.3. Floor.
21. Red Polished II incised, pear-shaped jug with round base; tall, tapering neck, wide funnel-rim, and handle from rim to shoulder. Bands of horizontal lines around neck and shoulder, and antithetic, concentric semicircles, separated by straight and zigzag lines on body. Height 14.4. Floor.
22. Black Polished globular amphora with round base, concave neck, splaying rim, and two small handles from neck to shoulder. Horizontal, hatched bands around neck, shoulder, belly, and base, and a frieze of zigzag bands below belly. One handle missing. Height 8.3. Floor.
23. Red Polished III bowl as No. 10. Repaired. Diam. 11.6. Floor.
24. Red Polished II bowl as No. 11. A framed band of crossed zigzag lines around rim; body covered with a design of concentric semicircles and vertical bands, composed of short horizontal elements. Diam. 11.6. Floor.
25. Red Polished III squat, oblong pyxis with round base, rounded outline, and an oval mouth. Rim pierced by two holes. Concentric semicircles around rim; body covered with the same ornament with small chevrons as filling ornaments. Damaged. Height 12.0. Floor.
26. Red Polished III bowl of the same shape as No. 20, but with horizontal handle. Diam. 20.2. Floor.
27. Red Polished III large, globular jug with slanting shoulder, round base; cylindrical, convex neck; stilted, flat rim, and handle from neck to shoulder. Height 53.2. Floor.
28. Red Polished II large, globular jug with round base; tall, somewhat tapering neck; wide, splaying rim, a knobbed handle from neck to shoulder, and three small hemispherical bowls symmetrically arranged on shoulder. Pinched relief-lines on neck and shoulders. Height 69.3. Floor.
29. Red Polished II globular cooking-pot with round base, splaying rim; one large, elevated, and one small handle from rim to body. Region between rim and body marked with an incised horizontal line. Height 12.2. Floor.
30. Red Polished III pear-shaped jug with round base, widening neck, beaked mouth, and an elevated handle from rim to shoulder. A small knob opposite the handle. Height 23.5. Floor.
31. Red Polished incised, conical spindle-whirl with narrow base. Diam. 3.7.
Red Polished spindle-whirl similar to the previous one. Diam. 3.8. Floor.
32. Straight thick bronze pin with small, flattened head. Point missing. Length 25.6. Floor.
33. Bronze knife with straight sides, pointed end, two edges, low midrib, and triangular top with five rivets. Length 18.55. Width 3.1. Floor.
34. Straight bronze pin with pointed end, and thickening top. Flat wire wound around the middle. Length 12.3. Bronze pin with pointed end, and small button-head. Hooked. Length 14.4. Floor.
35. Several narrow spirals of flat bronze wire, probably used as hair-ornaments. Floor.
36. Red Polished II bowl as No. 11. Rim and projection chipped. Diam. 14.0. Floor.
37. Red Polished III globular amphora with round base; convex, cylindrical neck, splaying rim, and two knobbed, incised handles from neck to shoulder. Pinched relief-lines on neck and shoulder. Height 47.5. Floor.
38. Red Polished III jug as No. 27. Paint somewhat worn. Height 44.7. Floor.
39. Red Polished II incised jug as No. 21, but with a square, horizontal handle opposite the vertical one. Radiating bands of oblique lines on rim; bands of horizontal lines, flanked by small, concentric semicircles on neck; a band of framed, oblique lines around shoulder; body covered with a vertically arranged design of framed lattice-bands, and parallel, horizontal lines with small, hatched lozenges in the interstices. Handles decorated with incised lines. Height 27.5. Floor.
40. Red Polished II bowl as No. 11. Diam. 7.0. Floor.
41. Red Polished II bowl as No. 11. Diam. 10.0. Floor.
42. Red Polished II bowl as No. 11. Even red. Diam. 9.2. Floor.
43. Red Polished II bowl as No. 11. Diam. 13.2. Floor.
44. Red Polished III amphora as No. 37, but with straight, cylindrical neck. Button-ornaments in relief on neck. Height 44.3. Floor.

45. Red Polished III shallow, wide bowl with round base, a horizontal projection, pierced by two vertical holes below rim, and four slightly projecting knobs on rim. Bright red, slightly lustrous surface. Diam. 30.3. Floor.
46. Necklace of 21 spherical, white paste beads, varying in diam. from 1.1 to 1.7, and arranged in two rhythmical series; some small fragments of bronze (spirals) and silver-lead were found together with the necklace. Floor.
47. Necklace composed of 24 spherical white paste beads, varying in size from diam. 1.3. to diam. 1.5, and arranged in a single row with a rather great distance between the beads. Floor.
48. Straight bronze pin with pointed end and thickening, flattened head. Length 20.5. Floor.
49. Thin bronze needle with eyelet. Length 8.9. Thin bronze needle with flat eyelet. Length 8.6. Floor.
50. Red Polished III bowl as No. 5. Diam. 9.5. Floor.
51. Red Polished II pear-shaped jug with round base, short neck, wide funnel-rim, handle from rim to shoulder, and a square projection on shoulder opposite the handle. Bands of horizontal lines around neck; body covered with a skeuomorphic design of concentric circles, connected with bands of parallel lines, running in horizontal and oblique direction. Hooked chevrons serve as filling ornaments. Height 14.3. Floor.
52. Red Polished II bowl as No. 11. Rim chipped. Diam. 15.6. Floor.
53. Red Polished II bowl as No. 11. Rim chipped. Diam. 13.6. Floor.
54. Red Polished III globular jug with round base; cylindrical, cut-away neck; splaying rim, and handle from neck to shoulder. Height 13.7. Floor.
55. Red Polished III bowl as No. 5. Diam. 9.1. Floor.
56. Red Polished III bowl as No. 5. Diam. 10.0. Floor.
57. Red Polished II bowl as No. 11. Rim chipped. Diam. 9.5. Floor.
58. Red Polished III bowl as No. 5. Parallel zigzag lines around rim; parallel, oblique lines, forming lozenges, and thin vertical lines on body. Diam. 10.0. Floor.
59. Red Polished II bowl as No. 11. Diam. 14.8. Floor.
60. Red Polished II bowl as No. 11. Diam. 13.6. Floor.
61. Red Polished II bowl as No. 11. Rim chipped. Diam. 13.8. Floor.
62. Red Polished III shallow bowl with round base and an upwards-turned, horizontal handle on rim. Handle missing; surface worn. Diam. 10.2. Floor.
63. Red Polished III bowl as No. 5. Framed, parallel, interrupted zigzags around rim, and bands of oblique and punctured lines, vertically arranged on body. Diam. 10.5. Floor.
64. Red Polished II bowl as No. 11. Diam. 13.6. Floor.
65. Red Polished II bowl as No. 11. Diam. 14.1. Floor.
66. Red Polished III bowl as No. 62, but with an open spout opposite the handle. Handle missing. Diam. 10.2. Floor.
67. Red Polished II cooking-pot as No. 29, but with short, concave neck, and small handles. Height 16.1. Floor.
68. Red Polished III jug as No. 54. Height 16.6. Floor.
69. Red Polished III cult vase. Four hemispherical bowls form the square base of the vase, and are surmounted by a high, plank-shaped handle divided into three "stories" by three oblong holes cut in the longitudinal axis. The bowls are decorated with framed bands of parallel zigzags, and the handle is covered with parallel, oblique lines, arranged in horizontal bands. Height 30.2. Floor.
70. Red Polished III incised bowl as No. 5. Groups of oblique lines around rim, and vertical bands of oblique lines and herring-bone patterns from rim to base. Diam. 10.6. Floor.
71. Red Polished II bowl as No. 11. A band of parallel lines around rim and above base; a frieze of parallel zigzag lines around body. Diam. 12.0. Floor.
72. Red Polished III bowl as No. 10. Groups of oblique lines around rim; body decorated as No. 70, but with vertically arranged elements. Diam. 10.6. Floor.
73. Red Polished II jug as No. 21. Bands of horizontal lines around neck, and a chess-board pattern of horizontal, short lines covering the body. Rim chipped. Height 10.8. Floor.
74. Red Polished incised, biconical spindle-whirl. Diam. 3.6. Floor.
75. Black Polished bottle as No. 6. Bands of horizontal lines around neck; body covered with a skeuomorphic design of concentric circles connected with hatched and punctured bands, running horizontally and obliquely. Height 8.7. Found inside No. 77.
76. Black Polished amphoriskos as No. 22. A chess-board pattern of short horizontal lines around neck, and a rich design of antithetic, concentric semicircles on body. Not complete. Height 9.5.
77. Red Polished III bowl as No. 10, but without string-hole projection. Diam. 9.1. Floor.
78. Red Polished II bowl as No. 11. Diam. 13.6. Floor.
79. Straight bronze pin with flat, large "mushroom-head". Point missing. Length 21.1. Floor.
80. Bronze spiral of flat wire. Diam. 1.15. Floor.
81. Red Polished III pear-shaped jug with round base, backwards-curved neck, beaked mouth, handle from rim to shoulder, a string-hole projection opposite the handle, and a tubular spout below projection. Vertical zigzag lines and dots on neck and body. Spout missing. Height 18.0. Floor.
82. Red Polished II bowl as No. 11. Diam. 13.9. Floor.
83. Red Polished II bowl as No. 11. Diam. 9.5. Floor.
84. Red Polished III bowl as No. 5, but of shallow shape. Diam. 10.0. Floor.
85. Black Polished conical spindle-whirl. Diam. 4.6. Floor.
86. Bone pin with a widening top, pierced by an eyelet. Point missing. Length 6.6. Floor.
87. Red Polished III bowl as No. 5. Diam. 8.9. Floor.
88. Red Polished II jug as No. 51. Height 9.6. Floor.
89. Red Polished II bowl as No. 11. Diam. 16.5. Floor.

- 90. Red Polished incised, conical spindle-whirl. Diam. 3.85. Floor.
- 91. Red Polished III bowl as No. 84. Diam. 9.1. Floor.
- 92. Red Polished III bowl as No. 10. Rim chipped. Diam. 10.1. Floor.
- 93. Red Polished III jug as No. 81, but with twisted handle. Surface much worn. Spout missing; rim chipped. Height 17.8. Floor.
- 94. Black Polished bottle as No. 6. Bands of horizontal lines around neck, and hatched bands, alternating with herring-bone patterns from shoulder to base. Rim chipped. Height 7.5. Floor.
- 95. Red Polished III bowl as No. 10. Framed, oblique lines around rim, and parallel zigzags around body. Half of bowl missing. Diam. 9.5. Floor.
- 96. Red Polished II jug as No. 51, and chiefly of the same decoration; the base is marked with a band of staff-ornaments, composed of short, horizontal elements. Handles and piece of rim missing. Height 8.7. Floor.
- 97. Red Polished II jug as No. 21, but with a double knob opposite the handle. Bands of horizontal lines around neck; body covered with a band of lozenges, filled with parallel, straight and zigzag lines. Height 16.0. Floor.
- 98. Red Polished II jug as No. 51, but with a hooked projection. Rim chipped. Height 15.3. Floor.
- 99. Red Polished II cooking-pot as No. 67. Height 12.9. Floor.
- 100. Red Polished II jug as No. 97. Bands of horizontal lines around neck; body covered with a rich decoration, composed of concentric circles, hatched lozenges, hooked chevrons, and hatched triangles, arranged in bands, alternating with plain lozenges. The base is marked with a band of parallel lines, crossed by pairs of oblique lines. Handle, rim, and knob missing. Height 20.0. Floor.
- 101. Red Polished II bowl as No. 11. Diam. 7.5. Floor.
- 102. Fragments of a long, straight bronze pin with flat button-head. Floor.
- 103. Black Polished biconical spindle-whirl. Diam. 3.85. Floor.
- 104. Red Polished II bowl as No. 11. Diam. 9.3. Floor.*
- 105. Red Polished II bowl as No. 11. Diam. 13.0. Floor.
- 106. Red Polished II bowl as No. 11. Diam. 13.6. Floor.
- 107. Red Polished II bowl as No. 11. Diam. 16.4. Floor.
- 108. Red Polished II bowl as No. 11. Diam. 12.2. Floor.
- 109. Red Polished II bowl as No. 11. Diam. 13.4. Floor.
- 110. Fragments of a Polished II bowl as No. 11. Floor.
- 111. Red Polished II bowl as No. 11. Diam. 15.6. Floor.
- 112. Red Polished II globular jug with tall, tapering neck; wide, splaying rim, and an angular, knobbed handle from neck to shoulder. Pinched relief-lines on neck and shoulder. Rim missing. Height 71.5. Floor.
- 113. Red Polished II large, oval jug with round base; short, tapering neck, splaying rim, and handle from neck to shoulder. Height 49.1. Floor.
- 114. Fragments of a Red Polished II oval amphora with flattened base; short, concave neck, splaying rim, and two knobbed handles from neck to shoulder. Floor.
- 115. Red Polished III amphora as No. 44. Neck broken. Height c. 22.0. Floor.
- 116. Red Polished III oval hydria with round base; convex neck, splaying rim; two knobbed handles from neck to shoulder, and two horizontal, smaller handles on shoulder. Height 40.6. Floor.
- 117. Red Polished III hemispherical bowl with a horn-shaped projection, and open spout. Framed, oblique lines around rim; body covered with vertical bands of oblique lines and concentric semicircles. Incised lines on handle and spout. Diam. 15.2. Floor.

* Nos. 104—117 were put together of fragments and are not marked on the plan, Fig. 58: 1.

Summing up the Object Register of the five Chambers, we obtain the following diagram:

	P o t t e r y				B r o n z e										Gold & Silver	Silver-lead	Iron	Stone	Terracotta	Faience	Bone				
	R. P. II	R. P. III		Bl. P.	Wh. P. II	Pins	Needles	Knives	Dagger	Swords	Scrapers	Tweezers	Axes	Chisels	Awls	Rings	Rings	Pin & Ring	Lump	Whetstones	Spindle-whirls	Idols	Beads & Necklaces	Pin	
Chamber A	13. 47	24	25.	26 41	15. 19 56	11	10	8	5	2	1	4	9	29					32	58	42	28	43		
		27.	45.	46	19. 20	12	21	7	6	3	22	38	30							59	57				
		49.	50.	64	36. 36	16	35	34	14	18	63	31									67				
		65.	66		36. 44	17	52				23	33													
					44. 48	37					51														
					48. 55	39					60														
					55. 55	40					61														
					55. 55	53					62														
					55. 56	54																			
					56																				
	-2			-11	-1	-19	-1	-9	-1	-4	-3	-8	-3	-3	-2	-4			-1	-2	-3	-1	-1		

	Pottery								Bronze								Gold & silver	Silver-lead	Iron	Stone	Terracotta	Fat-ence	Bone							
	R. P. II		R. P. III		Bl. P.	Wh. P. II			Pins	Needles	Knives	Dagger	Swords	Scrapers	Tweezers	Axes	Chisels	Awls	Rings	Rings	Pin & Ring	Lump	Whetstones	Spindle-whirls	Idols	Beads & Necklaces	Pin			
Chamber B	6.	9.	14A.	22'	4.	7.	18	8		10	11	12	11	3	2							13		21	5.	5	36	14		
	23.	26.	27.	29	20.	24.	25				15				16						17			5.	5					
	37				28.	31.	32							35										5.	5					
					33																			5.	5					
																					-2		-1		19.	19				
																							19.	30						
																							34							
																							-15							
Chamber C	2.	3																												
		-2																												



Fig. 59. Lapithos. Tomb 322, dromos.



Fig. 60. Lapithos. Tomb 323.

The latest interment seems to be the second period in Chamber D, which can be dated to M. C. I. The other chambers comprise the whole period of E. C. III. The oldest is probably Chamber B.

TOMB 323 (Figs. 58: 2; 60; 61: 1)

	SIZE			
	Length	Width	Depth	Height
Dromos	2.72	1.74	0.74	—
Stomion A	0.45	0.82	—	—
Chamber A.....	2.22	3.72	—	—
Stomion B	0.48	0.90	—	0.54
Chamber B.....	2.59	2.91	—	1.26
Stomion C	0.45	0.79	—	—
Chamber C.....	3.24	3.61	—	c. 1.00
Stomion D	0.38	0.65	—	—
Chamber D	1.95	2.48	—	—

SHAPE

This tomb is situated in that part of the necropolis which has in modern times been used as a quarry, and has, therefore, been much damaged. The N. and the E. sides of the dromos were cut through for more than half their height, and the stomion of the N. chamber was deprived of its roof. From the dromos, four entrances lead to four different chambers: Chamber A on the E. side, B on the S. side, C on the W. side and D on the N. side. The roofs of all the chambers, except that of Chamber B, have collapsed. The destruction is partly due to the operations of the stone cutters, partly to the exceptionally high level on

which the tomb has been constructed. The shape of the dromos is of the usual type with one narrow, semicircular end, tapering sides, and a horizontal floor.

Chamber A was closed by several door stones, and had a short, widening stomion, sloping abruptly down to the chamber floor. The plan of the chamber is regularly "kidney-shaped" without niches, and the floor is horizontal.

Chamber B is roughly circular, and has a short, very steeply sloping stomion, blocked up by a slab of local limestone, wedged with smaller stones. Roof and walls form a flat vault.

Chamber C, the largest of the set, is roughly circular in shape and provided with a deep niche at the level of the floor. The stomion slopes very gently down to the horizontal floor, and was closed by a large, thin block of heavy, calcareous stone.

Chamber D is a small irregular oval. The stomion was destroyed and the door-stone missing. A step leads from the dromos down to the horizontal floor of the chamber, and near the W. wall is a small niche, about 0.25 m. above the floor. Through this niche the chamber communicates with Tomb 320, which has undermined the niche. The structural evidence shows that Tomb 323 D already existed, when Tomb 320 was cut on a lower level, and the archaeological evidence also corroborates the later date of Tomb 320. A hole in the opposite wall of this chamber connects it with Chamber A of the same tomb, but whether the connection was made purposely or not, cannot be stated.

STRATIFICATION

The dromos-filling was stirred up as a consequence of the stone cutters' work, and the original *chavara* was mixed with chips of rock and some extraneous earth.

The finds in all the chambers lay directly on the floor, and in Chambers A, C, and D, which were found fallen in, the find stratum was covered by thick layers of debris from the roofs. Finds and skeletal material were in bad state of preservation. In Chambers A, B, and D no human bones were found. The only indications of burials were thin layers of dark earth directly on the chamber floor. Near the back wall of Chamber C were found fragments of tibiae, femora and a humerus, indicating the site of one body, and at the S. end was a mouldered burial stratum.

BURIALS

As can be understood from the above description no conclusions as regards the sexes, or the original position of the dead bodies could be drawn.

FINDS (GROUPS: PL. XXXIX, I--6; TYPES: L. OF PL. II)

Chamber A

1. Red Polished II globular cooking-pot with round base; short, concave neck, and two handles from rim to shoulder. Height 18.7. Floor.
2. Red Polished II hemispherical bowl with a string-hole projection at rim. Black rim and inside. Damaged. Diam. 13.5. Floor.

3. Fragments of a bronze pin. Floor.
4. Fragments of a Red Polished II hemispherical bowl. Floor.

Chamber B

1. Red Polished II oval amphora with somewhat flattened base, widening neck, splaying rim, and two angular handles from neck to shoulder. Rim chipped. Height 23.3. Floor.

2. Red Polished II wide, globular cooking-pot with round base, short concave neck, and two handles from rim to shoulder. Part of rim and handle missing. Height 18.5. Floor.
3. Fragments of a Red Polished II amphora. Floor.
4. Long, narrow bronze sword with straight sides, pointed end, high midrib, two grooves near the tang, and solid, hooked tang. The blade of the sword is purposely bent in two directions. Length 58.8. Floor.

C h a m b e r C

1. Red Polished III oval amphora with round base; cylindrical neck, flat rim, and two small handles from neck to shoulder. Zigzags around neck and shoulder. Not complete. Floor.
2. Red Polished II hemispherical bowl and a string-hole projection at rim. Parallel, horizontal lines around rim, and vertical, oblique bands of parallel lines on body. Height 9.8. Floor.
3. Red Polished II bowl as No. 2, but without decoration. Diam. 13.5. Floor.
4. Red Polished III bowl, mainly as No. 3. Projection broken. Diam. 8.5. Floor.
5. Red Polished III large, globular jug with round base, cylindrical neck; flat, stilted rim, and incised handle from neck to shoulder. Incisions on neck. Not complete. Floor.
6. Fragment of an incised Red Polished II jug. Floor.
7. Red Polished II bowl as No. 3. Diam. 13.6. Floor.
8. Red Polished II incised, pear-shaped jug with round base, tapering neck; funnel-rim, and handle from rim to shoulder. Parallel, horizontal lines around neck and shoulder; body covered with a skeuomorphic design of concentric circles, connected by bands of parallel lines. Height 12.3. Floor.
9. Red Polished III globular jug with round base; tall, cylindrical neck, splaying rim, handle from neck to shoulder, and a string-hole projection opposite the handle. Height 25.2. Floor.
10. Red Polished II jug as No. 8, but with two necks, and a fork-handle from necks to shoulder. Parallel, horizontal lines around the necks; body covered with a simple design of horizontal and vertical bands of parallel lines. Height 13.0. Floor.
11. Red Polished II bowl as No. 3. Not complete. Diam. 13.6. Floor.
12. Red Polished II bowl as No. 3. Rim chipped. Diam. c. 14.5. Floor.
13. Red Polished II bowl as No. 3. Diam. 11.3. Floor.
14. Red Polished II jug as No. 8, but with shorter neck and squat body. Height 12.0. Floor.
15. Red Polished II globular cooking-pot with round base, splaying rim, a handle from rim to body, and a flat, vertical projection at rim opposite the handle. Height 10.5. Floor.
16. Red Polished III oval tripod pot with round base, three solid legs below base; wide, concave neck, outwards-bent rim, and two fork-handles from rim to shoulder.

Incised rope-ornaments in relief on neck and shoulder. Height 45.1. Floor.

17. Red Polished II jug as No. 8, but with taller neck. Parallel, horizontal lines around neck and shoulder; body covered with bands composed of bundles of irregular, oblique lines, framed by horizontal lines. Height 19.7. Floor.
18. Red Polished II jug as No. 8. Parallel, horizontal lines around neck; body covered with antithetic, concentric semicircles, and parallel, oblique lines. Handle missing. Height 12.6. Floor.
19. Red Polished III bowl as No. 4. Diam. 9.7. Floor.
20. Red Polished II bowl as No. 3. Diam. 15.6. Floor.
21. Bronze sword with straight sides, pointed end, high midrib, two edges, round shoulders with deep grooves near the tang, and hooked, solid tang. Length 46.0. Floor.
22. Straight bronze pin with button-head. Length 8.75. Straight bronze pin with button-head and windings around the lower part. Length 20.25. Bronze pin as above. Length 19.8. Floor.

C h a m b e r D

1. Red Polished III large, globular jug with round base, and handle from neck to shoulder. Upper part of neck missing. Paint worn. Height c. 64.0. Floor.
2. Straight bronze pin with pointed end. Length 10.0. Floor.
3. White Painted III globular amphora with round base; cylindrical neck, flat rim, and two small, knobbed handles from base of neck to shoulder. Neck and body covered with framed friezes of hatched triangles and lozenges. Paint worn. Height 21.0. Floor.
4. Red Polished III globular jug with round base, cylindrical neck, beaked mouth, knobbed handle from rim to shoulder, and a small projection opposite the handle. Height 21.5. Floor.
5. Red Polished III jug as No. 4, but with plain handle. Height 19.7. Floor.
6. Red Polished II pear-shaped jug with tapering neck, round base, wide funnel-rim, and handle from rim to shoulder. Height 7.0. Floor.
7. Bronze tweezer with loop-shaped top. Length 8.85. Floor.
8. Flat bronze scraper with straight sides, rounded end and shoulders, and narrow, flat tang with one rivet-hole. Length 12.0. Floor.
9. Bronze sword with straight sides, pointed end, two edges, midrib; tapering, heart-shaped shoulders, and solid, hooked tang with traces of wire wound at the root. Length 43.3. Floor.
10. Red Polished incised, conical spindle-whirl. Diam. 5.0. Floor.
11. Red Polished III globular cooking-pot with round base; short, wide neck, and two handles from rim to shoulder. Height 15.3. Floor.
12. Red Polished III globular jug with round base; wide cylindrical neck, handle from rim to shoulder, a vertical string-hole projection, and an upright horizontal handle on the opposite side of the shoulder. Height 21.4. Floor.

A summary of the Object Register yields the following diagram:

	P o t t e r y			B r o n z e			T e r r a c o t t a	
	R. P. II	R. P. III	Wh. P. III	Pins	Swords	Scraper	Tweezer	Spindle-whirl
Chamber A	1. 2. 4 -3			3 -1				
Chamber B	1. 2. 3 -3				4 -1			
Chamber C	2. 3. 6 7. 8. 10 11. 12. 13 14. 15. 17 18. 20 -14	1. 4. 5 9. 16. 19 -6		22. 22. 22 -3	21 -1			
Chamber D	6 -1	1. 4. 5 11. 12 -5	3 -1	2 -1	9 -1	8 -1	7 -1	10 -1

CHRONOLOGY

To judge from their contents, Chambers A and B are older than C and D. They only contain Red Polished II vases and must be dated to the E. C. II period. In Chamber B amphora No. 1 is of a fairly early type, which indicates an early date within the period. C and D belong both to E. C. III, but C is, of course, the older one of the two. The presence of the White Painted III amphora No. 3 in Chamber D brings the last burial of the tomb down to the very end of E. C. III.

SUMMARY

Thanks to stratigraphical and typological evidence the relative dates of the tombs and of the different burials in them have been fairly well fixed, and enables us to put them into a chronological diagram. The typological differences between the contents of the tombs belonging to the same large chronological groups, and the archaeological dates make it necessary to divide the periods Early Cypriote I, II and III and Middle Cypriote I and II into smaller sub-periods conventionally called Early Cypriote I A and B; Early Cypriote II A, B and C; Early Cypriote III A, B and C; Middle Cypriote I A, B and C, and finally Middle Cypriote II A and B. Early Cypriote I and Middle Cypriote II are divided into only two sub-periods. The reason is that the archaeological material does not permit of further subdivisions. The Roman figures after the numbers of the tombs signify the different burial periods.

E. C. I A	303 A ¹	1 burial group
E. C. I B	308 ¹	1 burial group

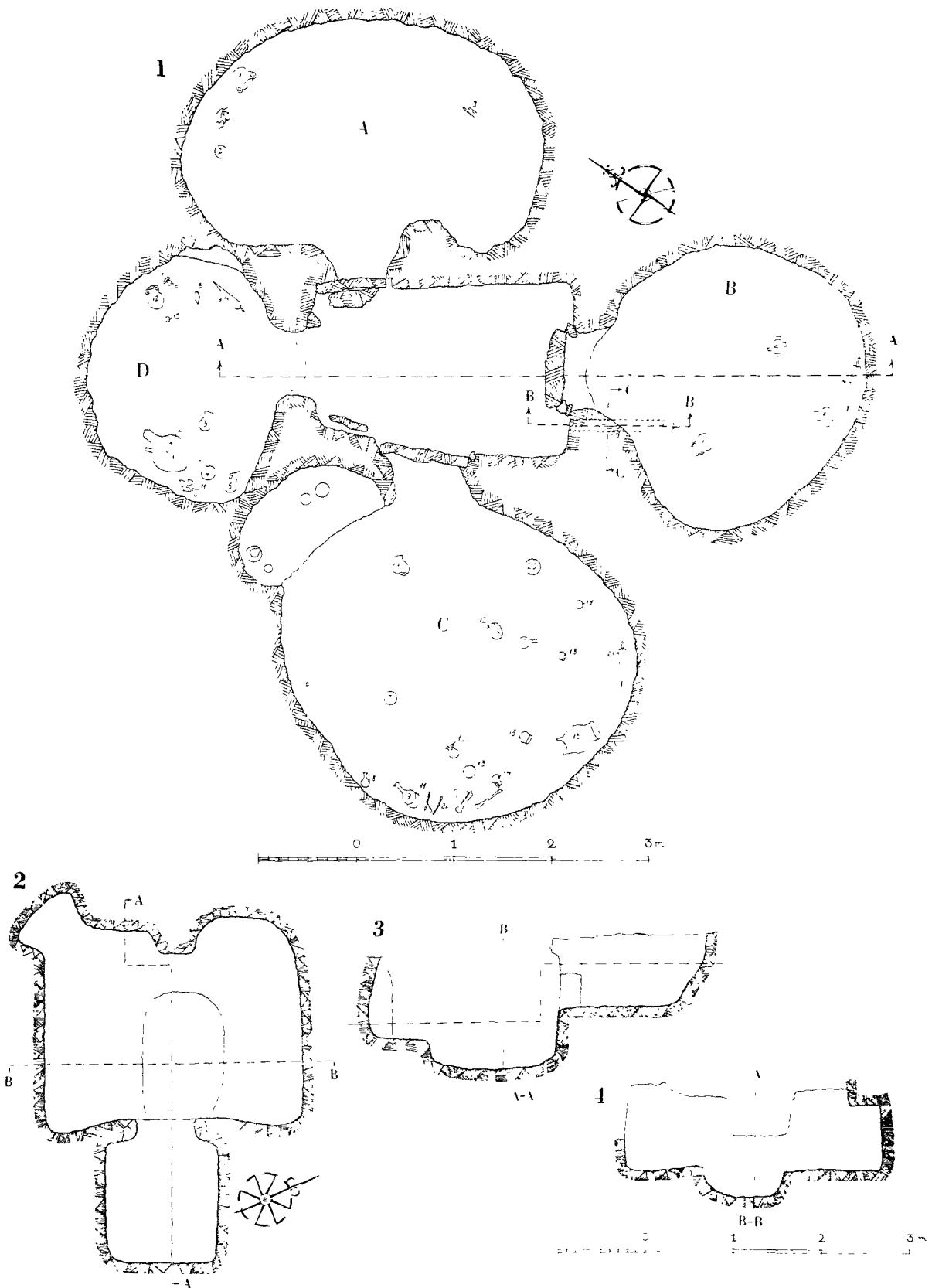

Fig. 61. Lapithos. Tomb 323, Plan (1). Tomb 501, Plan (2); Sections A-A, B-B (3, 4).

E. C. II A	301 A ^I , 301 B ^I , 303 A ^{II} , 304, 308 ^{II-IV} , 312 A ^I , 312 B, 318 ^I	9 burial groups
E. C. II B	301 B ^{II} , 301 C, 305 B, 306 A ^I , 306 C ^I , 311 B ^I , 311 A ^I , 312 A ^{II} , 323 B	9 burial groups
E. C. II C	305 A ^I , 309 A ^I , 314 B ^I , 323 A	4 burial groups
E. C. III A	301 A ^{II} , 302 A, 302 B, 302 C, 305 A ^{II} , 309 A ^{II} , 309 B, 314 B ^{II} , 317, 318 ^{II} , 322 B	10 burial groups
E. C. III B	306 A ^{II} , 306 C ^{II} , 311 B ^{II} , 313 A ^I , 313 C—D ^{I-II} , 314 A, 319 A, 319 C, 322 C, 323 C	11 burial groups
E. C. III C	307 A ^I , 307 B, 313 A ^{II-III} , 313 B ^{I-II} , 319 B, 322 A, 322 D ^I , 322 E, 323 D	11 burial groups
M. C. I A	303 B, 307 A ^{II} , 322 D ^{II}	3 burial groups
M. C. I B	311 A ^{II} , 320 ^I	2 burial groups
M. C. I C	315 A ^I , 315 B—C ^I	2 burial groups
M. C. II A	315 A ^{II} , 315 B—C ^{II} , 316 ^I	3 burial groups
M. C. II B	316 ^{II} , 320 ^{II}	2 burial groups

The diagram shows clearly enough that the burial ground was in frequent use during the whole periods E. C. II and III. In E. C. I the part investigated was not used to any great extent. The same holds good for M. C. I and II.

A comparison between this result and the field-map shows that there is no actual relationship between topography and chronology. The two earliest tombs (303 A and 308) are found at a distance of about 40 m. from each other, and between them are found such definitely late tombs as 303 B and 313. Contemporary tombs as 313, 323, and 322 lie at still greater distances from each other. Perhaps a further investigation of the central space between Tombs 303 and 313 might throw some light of the topographical arrangements of the necropolis.

E. S.

The necropolis at Kylistra and Ajia Anastasia

The village of Lapithos climbs up the steep northern slope of the Kerynia mountains, and is built in terraces, connected by narrow zigzag roads. On a natural plateau high up in the village lies the church of Ajia Anastasia, surrounded by the school and a modest little hotel. On the flat ground on top of the plateau and in a ravine to the south of the same Mr. Markides excavated some tombs in 1914, 1915, and 1917 with most interesting results.¹ Most of the tombs contained two layers, one assignable to Late Cypriote times,



Fig. 62. Lapithos. Tomb 501.

Fig. 63. Lapithos. Tomb 702. Finds *in situ*.

and the other to the early Iron Age. Such a result invited to further investigations. The upper regions of Lapithos and the plateau of Ajia Anastasia itself were searched during a week of trial-diggings, but the result was rather discouraging. No intact tombs of the periods concerned were found.

By the side of the road leading from the quarters of Ajia Paraskevi to Kefalovryso — the head spring of the village — at a locality called Kylistra there were found traces of two tombs, which were excavated. They are described here below under the numbers 701 and 702. At Ajia Anastasia two of the tombs, previously excavated by Mr. Markides, were re-investigated in order to obtain new drawings, as the old ones were never published. These tombs are recorded under their old numbers, 501 and 502.

TOMB 501 (Figs. 61: 2—4; 62)

	SIZE		
	Length	Width	Depth
Dromos	1.43	1.26	0.80
Stomion	0.20	0.63	
Chamber	2.16	2.92	

SHAPE

The dromos is a short, rectangular pit with rounded corners. The walls are perpendicular, except for the back wall which slopes gently down to the horizontal floor. The stomion is short and leads down to the chamber by means of a deep step.

Inside the doorway is an oblong pit sunk into the floor of the chamber. The chamber

is roughly square with an excrescence at the back wall. At the S. W. corner there is a small niche on a level with the floor. A house stands above a part of the chamber.

CHRONOLOGY

The tomb is dated by Gjerstad,² who shows that its latest burials fall within the Late Cypriote III period. That the tomb was in use a rather long time is clear from the fact that it contained some twenty skulls. The great number of Base-ring and Levanto-Helladic vases together with Bucchero and Submycenaean Wares point in the same direction. The earliest burials ought to be assigned to Late Cypriote II. To this period belong also some fragments of a beautiful bird-shaped vase of painted faience, which had escaped the observation of the first excavator, and now were found in the filling of the chamber.

TOMB 502

	Length	Width
Stomion	0.22	0.72
Chamber	2.68	3.42

SHAPE AND CHRONOLOGY

The tomb was found at the place where the ravine is cut through by the road leading up to the plateau. The construction of the road, which here is cut in the rock, has destroyed the dromos.

The chamber is round with flat floor, and an oval basin sunk into the floor. The roof can be reconstructed as a flat, rounded vault. The structure is of mainly the same type as the usual prehistoric cave tomb of Cyprus. Its date is fixed by Gjerstad³ at about the same time as Tomb 501. It contained two layers. The bottom layer may reach to the times of the end of Late Cypriote II, and comprises also Late Cypriote III. The upper layer continues into the developed Iron Age.

TOMBS 701 and 702 (Figs. 63; 64)

Of the two tombs at Kylistra there was very little left. The road had cut right through the chambers and only the back part of each tomb was left more or less intact in the bank of the road. There lay great quantities of pottery, mixed with remains of human skeletons, all packed in a silted layer of clay and rock debris. The thickness of the layer was about 0.5 m. Under such conditions it is of no use to deal in detail with the stratigraphy or to make an attempt to divide the finds into different groups. The Object Registers of the two tombs are given here below.



Fig. 64. Lapithos. Kylistra.

TOMB 701. FINDS (GROUP: PL. XXXIX, 7; TYPE: PL. CXV, 6)

1. Red Slip Wheel-made squat jug with base-ring, cylindrical neck, splaying rim, and handle from neck to shoulder. Height 17.2.
2. Submycenaean oval jug with base-ring; short, concave neck; a basket-handle over mouth, and a tubular spout on shoulder. Encircling lines around rim, neck, belly, and base, transverse lines on handle and spout. Red, mat paint. Spout chipped. Height 27.3.
3. Plain White Wheel-made jug with flat base, tapering neck, pinched mouth, and handle from rim to shoulder. Incised, encircling lines around neck and base. Height 23.4.
4. Submycenaean jug as No. 2, but with tapering, concave neck. Encircling lines around rim and neck, vertical lines from neck to base, and transverse lines on handle. Red, mat paint; almost obliterated. Height 17.3.
5. Submycenaean shallow bowl with flat base and rounded outline. Encircling lines around rim and body, and an encircled spiral inside the bottom. Dark, mat paint. Diam. 11.6.
6. Plain White Wheel-made oval jug with base-ring, tapering neck, splaying rim, a ridge below neck, and handle from rim to shoulder. Height 19.1.
7. Plain White Wheel-made jug as No. 6, but without ridge below neck. Height 15.7.
8. Plain White Wheel-made oval jug with base-ring; narrow, concave neck, flat rim, a ridge below neck, and handle from neck to shoulder. Height 28.1.
9. Plain White Wheel-made oval jug with flat base; tapering neck, stilted rim, three ridges below neck, and handle from neck to shoulder. Height 31.2.
10. Wheel-made oval Bucchero jug with base-ring, tapering, tall neck, profiled rim, and handle from rim to shoulder. Fluted body. Height 14.9.
11. Plain White Wheel-made oval jug with base-ring, concave neck, and a ridge below neck, handle, and pieces of body missing. Height 24.9.
12. Plain White Wheel-made oval jug with base-ring; tapering, concave neck, splaying rim, a ridge below neck, and handle from neck to shoulder. Rim chipped. Height 23.8.
13. Plain White Wheel-made oval jug with flat base, concave

- neck, and handle from rim to shoulder. Front of rim missing. Height 41.0.
14. Black Slip II pear-shaped jug with round base, cylindrical neck, beaked mouth, and an angular handle from neck to shoulder. Incised, wavy and straight lines on neck and handle. Height 16.2.
 15. Red Slip globular jug with round base, tapering neck, beaked mouth, and handle from neck to shoulder. Height 16.8.
 16. Black Slip II globular jug with round base, cylindrical neck, splaying rim, slightly pinched mouth, handle from rim to shoulder, and small projections on top of handle and opposite the handle. Height 18.1.
 17. Plain White Wheel-made jug as No. 12. Handle missing; rim chipped. Height 18.2.
 18. Plain White Wheel-made jug as No. 8. Height 24.0.
 19. Red Slip globular jug with round base, handle from neck to shoulder, and a projection opposite the handle. Neck missing. Height 25.1.
 20. Black Slip III globular jug with round base; short, widening neck, and a high handle from rim to shoulder. Vertical, incised zigzag lines around rim. Height 8.0.
 21. Black Slip II globular jug as No. 14. but with rounded handle. Projections on shoulder and opposite the handle, and a score on handle. Height 28.2.
 22. Red Slip pear-shaped jug with round base; narrow, convex neck; funnel-rim, and handle from neck to shoulder. Vertical, incised tree-ornaments from neck to belly; hatchings on neck, and button-ornaments on shoulder. Height 20.6.
 23. Fragments of oblong, thick earrings of bronze.
 24. Circular bronze button and five oblong earrings of bronze. Diam. of the button 3.2. Length of the earrings 2.8.
 25. Monochrome globular jug with round base; wide, tapering neck, slightly pinched mouth, and handle from rim to shoulder. Handle partly missing. Height 14.5.
 26. Squat Base-ring II jug with cylindrical neck, thick rim, and handle from rim to shoulder. Height 8.4.
 27. White Painted Wheel-made oval jug with flat base, concave neck, and a tubular spout opposite the handle. Encircling lines around neck and spout, and vertical lines from neck to base. Rim and handle missing. Height 7.8.
 28. Lower part of a bobbin-shaped White Shaved bottle with pointed base.
 29. Three oblong earrings of bronze. Length 3.3.

The Object Register is summed up in the diagram.

P o t t e r y													B r o n z e	
H a n d - m a d e						W h e e l - M a d e								
Red Sl.	Bl Sl. II	Bl. Sl. III	Base-ring II	Wh. Shaved	Monochrome	Bucchero	Pl.Wh.	R. Sl.	Wh. P.	Submycenaean	But-ton	Ear-rings		
15. 19	14. 16	20	26	28	25	10	3. 6	1	27	2. 4. 5	24	23. 24		
22	21						7. 8					24. 24		
							9. 11					24. 24		
							12. 13					29. 29		
							17. 18					29		
-3	-3	-1	-1	-1	-1	-1	-10	-1	-1	-3	-1	-9		

TOMB 702. FINDS (GROUP: PL. XL; TYPES: L. OF PL. II)

1. Plain White Wheel-made oval jug with base-ring, concave neck, splaying rim, and handle from rim to shoulder; ridge below neck. Pieces of rim and neck missing. Height 16.5.
2. Squat Base-ring II jug with cylindrical neck, thick rim, and handle from rim to shoulder. Height 9.0.
3. Plain White Wheel-made oval jug with base-ring; neck, handle, and pieces of body missing. Height 7.9.
4. Base-ring II jug as No. 2. Not complete. Height 8.4.
5. Base-ring II jug as No. 2. Height 10.1.
6. White Shaved bobbin-shaped bottle with pointed base, concave neck, slightly pinched mouth, and handle from rim to shoulder. Height 16.0.
7. Globular jug of Coarse Ware with flattened base, conical neck, thickening rim, and handle from rim to shoulder. Height 14.4.
8. Black Slip II pear-shaped jug with round base, cylindrical neck; slightly splaying, oblique rim, and a high handle from rim to shoulder. Paint worn. Height 15.8.
9. Submycenaean, shallow bowl with raised, flat base, and a horizontal handle below rim. Encircling lines outside and inside; dark, mat paint. Rim chipped. Diam. 16.4.
10. White Painted Wheel-made globular jug with flat base, concave neck, splaying rim, handle from rim to shoulder, and a tubular spout opposite the handle. Encirc-

- ling lines around rim, neck, and spout; vertical lines from neck to base, and a vertical line on handle. Spout missing. Height 10.2.
11. Levanto-Helladic shallow cup with raised, flat base, concave sides, and handle from rim to body. Encircling lines outside and inside. Dark, slightly lustrous paint. Rim chipped. Diam. 8.9.
 12. Plain White Wheel-made oval jug with base-ring, concave neck, splaying rim, a tubular spout on shoulder, and a basket-handle on rim. Handle missing. Height 14.8.
 13. Plain White Hand-made oval jug with large, flat base, concave neck, an impressed line below neck, and handle from rim to shoulder. Traces of the tournette visible inside. Rim chipped. Height 29.8.
 14. White Painted IV shallow bowl with round base, inwards-turned sides, slightly splaying rim, and a high wish-bone handle below rim. Encircling lines around rim and body; parallel, oblique lines below rim; bands of parallel lines, meeting in a cross at base; a wavy line inside rim, and transverse lines on handle. Diam. 9.2.
 15. Plain White Wheel-made oval with handle from rim to shoulder; a ridge below neck. Not complete.
 16. Globular cooking-pot of Coarse Ware with round base; wide, cylindrical neck, splaying rim, a handle from rim to shoulder, and a small projection opposite the handle. Height 10.0.
 17. Red Slip globular jug with round base; narrow, cylindrical neck, splaying rim, and a high handle from rim to shoulder. Handle missing. Height 10.8.
 18. Plain White Wheel-made oval jug with base-ring, concave neck, and handle from neck to shoulder. Rim and piece of handle missing. Height 19.7.
 19. Black Slip Wheel-made bobbin-shaped jug with narrow base-ring and neck. Neck and handle missing. Height 10.9.
 20. Base-ring II jug as No. 2. Handle missing. Height 10.1.
 21. White Painted Wheel-made oval jug with flat base, tapering neck; splaying, profiled rim, handle from rim to shoulder, and a tubular spout opposite the handle. Encircling lines around rim and body. Vertical lines from neck to belly. Height 17.5.
 22. White Painted Wheel-made jug as No. 10, but with base-ring, and a ridge below neck. Height 13.3.
 23. Red Slip Wheel-made shallow bowl with base-ring, curved outline, and widening rim. Not complete. Diam. 19.5.
 24. Red Slip Wheel-made oval jug with flattened base, tapering neck, splaying rim, handle from rim to shoulder, and a ridge below neck. Rim chipped. Height 25.9.
 25. Red Polished IV globular bottle with round base; tall, tapering neck, splaying rim, and two small, vertical handles on shoulder. Rim chipped. Height 8.6.
 26. White Painted V globular jug with flat base. Neck and handle missing. Decoration obliterated. Height 12.3.
 27. Red Slip globular jug with tapering neck, beaked mouth, and handle from rim to shoulder. Handle missing; rim chipped. Height 11.4.
 28. Black Slip II globular jug with round base, narrow neck, beaked mouth, and handle from neck to shoulder. Projections on neck and shoulder, and a score on handle. Top of rim missing. Height 23.0.
 29. Black Slip II pear-shaped jug with round base; wide, concave neck, an impressed line below neck, and a knobbed handle from rim to shoulder; a projection opposite the handle. Height 26.7.
 30. Red Slip pear-shaped jug with round base; cylindrical, slightly convex neck, and an elevated handle from rim to shoulder. Pieces of rim missing. Height 12.3.
 31. Fragments of a Plain White Wheel-made jug with concave, narrow neck, splaying rim, a ridge below neck, and handle from neck to shoulder.
 32. Red Slip squat, globular amphora with round base, concave neck, splaying rim, two angular handles from neck to shoulder, and bands of incised, wavy lines around neck and shoulder. Height 19.9.
 33. Bronze scraper with two edges, rounded corners, and long, flat tang. Length 10.7.
 34. Two bronze bracelets with overlapping ends. Diam. 5.7. One smaller ring of the same shape. Diam. 3.8. Fragments of a boat-shaped earring of bronze. Diam. 1.7.
 35. Black Slip II globular jug with round base; cylindrical, convex neck, beaked mouth, and handle from neck to shoulder. Incised bands of wavy lines around neck and shoulder, and from neck to base. Height 11.9.
 36. Black Slip II pear-shaped jug with round base, cylindrical neck, beaked mouth, and handle from rim to shoulder. A small projection opposite the handle. Pieces of rim missing; paint worn. Height 14.4.
 37. Black Slip II oval jug with round base, cylindrical neck, plain rim, and handle from rim to shoulder. Piece of rim and handle missing. Paint worn. Height 12.9.
 38. Red Slip pear-shaped jug with round base, cylindrical neck, slightly pinched mouth, and an angular handle from rim to shoulder. Height 14.3.
 39. Black Slip II pear-shaped jug with round base, slightly tapering neck, splaying rim, and a high handle from rim to shoulder. Height 11.0.
 40. Black Slip III lentoid bottle with base-ring; narrow neck, funnel-rim, and a small handle from neck to body. Straight and zigzag lines in thin relief around neck, and from neck to base. Paint obliterated. Height 12.2.
 41. Black Slip II shallow bowl with round base, and a large string-hole handle below rim. Diam. 19.4.
 42. Red Polished IV globular jug with round base; narrow, cylindrical neck, wide rim, slightly pinched mouth, projection opposite the handle, and handle from rim to shoulder. Handle partly missing. Height 18.7.
 43. Black Slip II globular jug with round base, cylindrical neck, splaying rim, oblique mouth, and an angular, high handle from rim to shoulder. Height 15.5.
 44. Fragments of a bronze tweezer.

45. Spherical mace-head of stone, pierced by a tapering hole through centre. Diam. 6.6.
46. Black Slip II squat jug with flattened base; wide neck; string-hole on shoulder, and a high, knobbed handle from rim to shoulder. Pinched relief-lines around rim and neck, and a score on handle. Height 10.6.
47. Red Polished IV globular jug with round base, wide neck, plain rim, and handle from rim to shoulder; a knob at top of handle, and a string-hole projection opposite the handle. Height 15.5
48. Black Slip II shallow bowl as No. 41. Diam. 22.4
49. Globular cooking-pot of Coarse Ware, as No. 16. Height 11.1
50. Black Slip II squat jug with round base, wide, tapering neck, flat rim, and a high, knobbed handle from rim to shoulder. Vertical and wavy lines in thin relief around rim, neck, and shoulder, and a knobbed string-hole projection opposite the handle. A string-hole through top of handle. Height 16.0.
51. Black Slip II oval jug with round base, narrow neck, splaying rim, and a string-hole handle from neck to shoulder. Height 10.9.
52. Red Slip shallow bowl with round base, and a horizontal handle on rim. Handle missing. Paint worn. Diam. 8.6
53. Red Slip shallow bowl with rounded base, inwards-turned rim, and a wish-bone handle below rim. Diam. 9.0.
54. Red Polished IV shallow bowl with round base, and a large string-hole handle at the rim. Diam. 19.7.
55. White Painted V globular jug with round base; narrow, cylindrical neck, beaked mouth, and handle from neck to shoulder. A network pattern of oblique and vertical bands of parallel lines covering neck and body. Height 13.1.
56. Globular cooking-pot of Coarse Ware with round base; not complete. Height 11.7.
57. Black Slip II squat jug with round base; wide, cylindrical neck, flat rim, and a knobbed, angular, high handle from rim to shoulder. String-hole projections below and opposite the handle; impressed circles on rim and top of handle; incised bands of vertical and zigzag lines around neck and body; a score on handle. Height 23.3.
58. Black Slip II pear-shaped jug with round base, cylindrical neck, beaked mouth, and handle from neck to shoulder. Paint obliterated. Height 16.6.
59. Black Slip II pear-shaped jug with round base; narrow, cylindrical neck, funnel-rim, and a knobbed handle from rim to shoulder. Incised bands of zigzag lines around neck and shoulder, two vertical, incised lines on handle. Height 20.2.
60. Black Slip II jug as No. 46. An incised, wavy line around neck and a horizontal line around shoulder; a vertical, wavy line at root of handle; impressed, circular dots on rim. Height 12.3.
61. Globular cooking-pot of Coarse Ware with wide, cylindrical neck, round base, and handle from rim to shoulder. Height 16.5.
62. Black Slip II globular jug with round base, cylindrical neck, splaying rim, and a knobbed handle from neck to shoulder. Incised, horizontal lines around neck and shoulder, a framed, vertical, wavy line as front ornament, and vertical lines from neck to belly near the handle. Height 18.0
63. White Painted V miniature jug with round base, concave neck, and a string-hole handle from neck to shoulder. Encircling lines around rim, neck, and belly, hatched triangles on shoulder, and bands of vertical lines from belly to base. Decoration almost obliterated. Height 6.7.
64. Black Slip II pear-shaped jug with round base, wide, tapering neck, splaying rim, pinched mouth, a high handle from rim to shoulder, and a small projection opposite the handle. Paint worn. Height 18.1
65. Black Slip II shallow bowl with round base, and a horizontal, high, profiled, and knobbed handle at rim. Reddish slip inside. Diam. 10.0.
66. Black Slip II globular jug with round base; tall, tapering neck; widening rim, oblique, pinched mouth, and a high, knobbed handle from rim to shoulder; a string-hole projection opposite the handle. Paint partly worn. Height 37.3.
67. Red Slip pear-shaped jug with round base, tapering neck, beaked mouth, and handle from neck to shoulder. Incised bands of vertical, wavy lines from neck to belly; encircling lines around neck, and two vertical lines from spout to shoulder. Height 21.5.
68. Red Slip sack-shaped bottle with narrow, cylindrical neck, funnel-rim, and two string-hole handles from neck to shoulder. Rim chipped. Height 9.8.
69. White Painted V globular jug with round base; short, wide, cylindrical neck; plain rim, and a knobbed, high handle from rim to shoulder; a flat projection on shoulder opposite the handle. Encircling bands of parallel lines around rim, neck, shoulder, and belly; hatched triangles on shoulder; a horizontal zigzag band around belly; bands of zigzags and straight lines from belly to base; framed, wavy lines from handle to base, and as front ornament; zigzag bands on handle; horizontal, wavy lines and vertical, straight lines inside the rim, and transverse lines on the projection. Paint worn. Height 19.5.
70. White Painted III pear-shaped jug with round base; narrow, cylindrical neck, splaying rim, and handle from rim to shoulder; a small projection opposite the handle. Encircling lines around rim, neck, and base; broad lattice-bands and framed zigzag lines from neck to base; a vertical line on handle; a cross of wavy lines on base, encircled by two concentric circles of wavy lines. Paint worn. Height 16.6.
71. Black Slip II squat amphora with round base; wide, cylindrical neck; flat rim, and two knobbed handles from neck to shoulder. Incised, straight and wavy lines around rim, neck, and shoulder. Height 19.8.
72. Black Slip II shallow bowl with round base and a high, horizontal handle on rim. Handle missing. No slip inside. Diam. 10.6.

73. Black Slip II squat jug with wide, cylindrical neck; flat rim, and handle from rim to shoulder. A string-hole projection opposite the handle. Incised, vertical and zigzag lines around rim, neck, and shoulder. Handle missing, chipped. Height 17.0.
74. Black Slip II pear-shaped jug with round base, backwards-curved, tapering neck; splaying rim, and a high handle from rim to shoulder. Encircling zigzag bands around neck and shoulder; a score on handle; a dotted line below neck, and two vertical lines as front ornament. Height 15.5.
75. Red Polished IV globular amphora with round base, cylindrical neck, slightly splaying rim, and two handles from neck to shoulders. Incised zigzag lines around neck, and scores on handles. Rim chipped. Height 28.0
76. Red Slip pear-shaped jug with round base, cylindrical neck, slightly pinched mouth, and a high handle from rim to shoulder. Paint worn. Height 9.3.
77. Black Slip II globular jug with round base; short, convex neck, funnel-rim, and a high, knobbed handle from rim to shoulder. Incised zigzag bands around neck, shoulder, and top of handle. Rim chipped. Height 18.4.
78. Fragment of a bronze leaf. Length 5.6.
79. Black Slip II squat, conical jug with flat base, wide neck; a high, knobbed handle from rim to body, and two small projections on neck opposite the handle. Impressed, circular dots, framed by ridges around rim, neck and body, and as front ornament; a score on handle. Height 13.3.
80. Black Slip II shallow bowl as No. 48. Diam. 26.2.
81. White Painted IV shallow bowl with inwards-turned sides, round base, slightly splaying rim, and a horizontal handle below rim. Encircling lines around rim and body; a wavy line inside the rim; parallel zigzag lines around body, and crossed bands on base; transverse lines on handle. Diam. 7.0.
82. Black Slip II globular bottle with round base; narrow, cylindrical neck, and two small handles from neck to shoulder. One handle missing; paint worn. Height 8.8.
83. Red Polished IV shallow bowl, with round base, slightly inwards-turned rim, and a horizontal handle below rim. Handle missing. Diam. 9.5.
84. Red Slip pear-shaped jug with round base; short, cylindrical neck; slightly pinched mouth, and handle from rim to shoulder. Paint worn. Height 8.8.
85. Black Slip II jug as No. 57. Projection not complete. Height 18.3.
86. Black Slip II pear-shaped jug with round base; convex, tapering neck, stilted rim, and handle from rim to shoulder. Not complete. Height about 16.0.
87. Red Slip shallow bowl with round base, and a projecting string-hole handle at rim. Diam. 22.6
88. Red Polished III globular jug with round base; convex, tapering neck, slightly splaying rim, and handle from neck to shoulder. Height 20.0.
89. Red Slip globular jug with round base, tapering neck, oblique, pinched mouth, a knobbed handle from rim to shoulder, and a small projection on shoulder opposite the handle. A band of parallel zigzag lines around neck; a wavy line from front of mouth to shoulder, and parallel zigzags on handle. Height 20.2.
90. Black Slip II amphora as No. 71. Bands of horizontal and wavy lines around neck and shoulder; paint worn. Piece of neck missing. Height 20.7.
91. Bronze ring with overlapping ends. Diam. 3.5
92. Black Slip II pear-shaped miniature jug, with round base; narrow, cylindrical neck; slightly pinched mouth, and handle from neck to shoulder. Base missing. Height 7.7.
93. Red Polished IV shallow bowl, with round base, a semi-circular spout at rim, and a string-hole handle opposite the spout below rim. Diam. 15.3.
94. Red Slip squat jug with round base; wide, cylindrical neck, slightly splaying rim, a knobbed handle from rim to shoulder, and two small projections opposite the handle. A vertical row of impressed dots, framed by two ridges as front ornament, and a score on projection of handle. Rim chipped. Height 16.6
95. Red Slip globular jug with round base, cylindrical neck, splaying rim, oblique mouth, a handle from rim to shoulder, and a small projection on shoulder opposite the handle. Parallel, wavy lines on neck, a score on handle. Height 11.3.
96. Red Polished IV shallow bowl with round base, and a string-hole handle at rim. Diam. 21.6.
97. Black Slip II bowl as No. 87. Diam. 26.9.
98. White Painted V deep bowl with round base; slightly splaying rim, and holes at rim. Encircling bands of parallel lines around rim and body, crossed bands at base, and a band of chevrons below rim, a framed, wavy line inside the rim. Rim chipped. Diam. 7.2.
99. White Painted IV bowl as No. 14. Bands of parallel lines around rim and body, crossed bands at base, and parallel zigzags below rim. Diam. 11.0.
100. Black Slip II globular jug with round base, cylindrical neck; splaying rim, oblique mouth, high handle from rim to shoulder, and a small projection on neck opposite the handle. Incised bands of parallel lines around neck and shoulder, and from neck to belly. Paint worn; rim chipped. Height 20.7.
101. Red Slip globular jug with round base; cylindrical, convex neck, oblique, pinched mouth, and a high handle from rim to shoulder. Piece of handle missing. Height 20.7
102. Two circular bronze rings. Diam. 3.9; 2.8.
103. Fragments of a Red Polished III jug with round base.
104. Bronze bracelet. Broken. Diam. 6.2.
105. Red Slip squat jug with round base; narrow, concave neck; plain rim, and a small handle from neck to shoulder. Height 7.8
106. Black Slip II pear-shaped jug, with round base, handle from neck to shoulder, and a small projection on shoulder opposite the handle. A band of parallel, wavy

- lines around neck and shoulder; vertical lines on handle and as front ornament. Neck partly missing Height 13.1.
107. Black Slip II globular jug with round base; wide, cylindrical neck, and string-hole projections on and opposite the handle. Bands of impressed dots and ridges around neck and body, and framed bands of the same pattern below handle and as front ornament. Not complete. Height 28.5.
108. Black Slip II pear-shaped jug with round base; concave, tapering neck; widening rim; a handle from neck to shoulder, and a projection opposite the handle. Zigzag lines around neck, and a score on handle. Height 24.4.
109. Black Slip II pear-shaped jug with round base, cylindrical neck, slightly splaying rim; handle from neck to shoulder, and two projections opposite the handle. Incised zigzag lines around neck, and a score on handle. Pieces of rim and neck missing. Height 27.5.
110. Black Slip biconical spindle-whirl with a zigzag incision. Diam. 3.6.
111. Red Slip shallow bowl with round base, and a horizontal handle below rim. Diam. 11.7.
112. Black Slip II globular jug with round base; tapering neck; splaying rim, handle from rim to shoulder, and a small projection on shoulder opposite the handle. Height 20.0.
113. Red Slip pear-shaped jug with round base; short, convex neck; slightly splaying rim, and a high handle from rim to shoulder. Handle missing. Height 12.4.
114. Red Slip shallow bowl with round base, and a horizontal handle at rim. Handle missing; rim chipped. Diam. 10.5.
115. Black Slip II jug as No. 50. Bands of wavy and straight lines around rim, neck and shoulder; short, vertical lines below neck; a score on handle, and framed, vertical, wavy lines below handles, and as front ornament. Height 14.3.
116. Fragments of a bronze bracelet.
117. White Painted III pear-shaped jug with round base, cylindrical neck, beaked mouth, and an angular handle from neck to shoulder. Encircling lines around rim and neck; broad lattice-bands alternating with vertical, wavy lines from neck to base; crossed bands at base, and transverse lines on handle. Rim and neck partly missing. Height 13.0.
118. Oval mace-head of stone pierced by a tapering hole through centre. Diam. 6.3.
119. Black Slip spindle-whirl as No. 110. Diam. 3.5.
120. Black Slip spindle-whirl as No. 110. Diam. 3.4.
121. Circular bronze bracelet. Broken. Diam. 5.4.
122. Small bronze tweezer with a loop-shaped top. Length 6.3.
123. Fragment of a whetstone, pierced by a hole through top. Length 4.1.
124. Red Slip globular jug with round base, cylindrical neck, splaying rim, oblique mouth, and a high handle from rim to shoulder. Paint obliterated. Height 10.8.
125. Red Slip oval jug with round base, wide, concave neck, and handle from rim to shoulder. Paint badly worn. Height 8.7.
126. Fragments of a circular bronze bracelet.
127. Thick, short bronze pin, with "mushroom-head", and an eyelet at middle of pin. Ridges on both sides of the eyelet. Length 8.6.
128. Bronze pin as No. 127. Length 13.2.
129. Black Slip II bowl as No. 87.
130. White Painted IV animal-shaped vase with four legs; a horned idol with indented sides at one end; a beaked spout at opposite end, and an upright handle at back. Network patterns on back, and parallel, oblique lines on lower part of body, encircling lines around legs and spout, and transverse lines on the idol.
131. Front piece of an axe-head of bronze, with curved edge, and straight, parallel sides. Length 4.8.
132. Bronze dagger with two edges, pointed end, midrib, and a solid, hooked tang. Length 28.0.
133. Bronze spiral. Diam. 0.8.
134. Black Slip II globular jug with round base; wide, concave neck; a high, knobbed handle from rim to shoulder, and a hooked projection opposite the handle. A zigzag line and impressed dots on handle. Rim chipped; paint worn. Height 17.3.
135. Mace-head as No. 118. Diam. 7.4.
136. White Painted III lentoid bottle with flat base; narrow, cylindrical neck, splaying rim, and a small handle from neck to body. Encircling lines around rim and neck; broad, vertical lines and framed bands of filled lozenges on body, and straight and wavy lines on base. Height 16.4.
137. Black Slip II bowl as No. 41. Diam. 27.7.
138. Spindle-whirl as No. 110. Diam. 2.8.
139. Globular cooking-pot of Coarse Ware with short, concave neck; splaying rim, and two handles from rim to body; scores on handles. Height 12.5.
140. Black Slip spindle-whirl as No. 110. Diam. 3.3.
141. Black Slip almost spherical spindle-whirl as No. 110. Diam. 3.5.
142. Black Slip spindle-whirl as No. 110. Diam. 3.3.
143. Red Polished IV pear-shaped jug with round base, cylindrical neck, slightly splaying rim, handle from neck to shoulder, and a projection on shoulder opposite the handle. Rim missing. Height 37.7.
144. White Painted III globular jug with flattened base; wide, concave neck; flat, splaying rim, a knobbed handle from rim to shoulder, and a string-hole handle on opposite side of neck. Bands of broad, vertical lines and framed, filled triangles around neck and body; a band of vertical and wavy lines from rim to neck; a framed band of lattice-lozenges below handle, and as front ornament; crossed, straight and wavy lines at base; parallel, oblique lines on the rim; a wavy line inside the rim and on handle. Projection of handle missing. Height 21.4.
145. Oval cooking-pot of Coarse Ware with round base, slightly concave neck, and handle from rim to shoulder. Height 13.4.

- 146. Black Slip spindle-whirl as No. 110. Diam. 3.5.
- 147. Black Slip II globular jug with round base; cylindrical, wide neck; flat rim, and handle from rim to shoulder. Two small projections on neck opposite the handle. Handle missing. Height 16.5.
- 148. Black Slip II globular jug with round base; tall, narrow neck; funnel-rim, and a small string-hole handle on shoulder. Paint worn. Height 8.9.
- 149. Black Slip II globular cup with round base; wide, concave neck, and handle from rim to shoulder. Height 7.7.
- 150. White Painted III jug as No. 144. Framed bands of filled lozenges around neck; bands of broad, vertical lines around shoulder and base; a frieze of latticed zigzag bands around belly; framed, wavy line from rim to shoulder; a lattice-lozenge below handle; crossed lines at base, and wavy lines on handle. Paint worn. Height 20.5.
- 151. Red Polished IV pear-shaped jug with round base; short, concave neck, splaying rim, and a vertical handle on shoulder. Height 14.2.
- 152. Black Slip II globular jug with round base; conical neck; splaying rim; pinched mouth, and handle from rim to shoulder. Paint worn. Height 18.3.
- 153. White Painted IV bowl as No. 81. Diam. 9.9.
- 154. Black Slip II bowl as No. 54. Diam. 21.7.
- 155. Red Polished IV globular jug with round base, cylindrical neck, beaked mouth, and handle from neck to shoulder. Pieces of rim missing. Height 22.5.
- 156. Plain, broken bronze pin. Length 9.6.
- 157. Leaf-shaped bronze knife with two edges, rounded end, and a flat tang with one rivet-hole. Traces of the wooden handle left. Length 7.4.
- 158. Bronze scraper with two edges, concave sides, straight ends, and flat, narrow tang. Length 11.6.
- 159. Leaf-shaped bronze knife with rounded ends, two edges, and flat, narrow tang. Length 8.4.
- 160. Two circular bronze rings with overlapping ends. Diam. 2.3.
- 161. Plain bronze pin; not complete. Length 5.4.
- 162. Bronze pin with spiral-head. Length 4.7.
- 163. Fragments of two bronze rings. Diam. c. 1.9.
- 164. Two bronze spirals. Diam. 1.3.

The Object Register in summed up in the following table:

Pottery														Bronze										Stone		Terra-cotta									
Hand-made							Wheel-made																												
R. P. III	R. P. IV	R. Sl.	Wh. P. III	Wh. P. IV	Wh. P. V	Bl. Sl. II	Bl. Sl. III	Base-ring II	Wh. Shaved	Pl. Wh.	Coarse W.	Pl. Wh.	R. Sl.	Bl. Sl.	Lev. Hell.	Submyc.	Wh. P.	Coarse W.	Dagger	Knives	Scrapers	Twizzers	Axe	Pins	Bracelets	Rings	Earrings	Spirals	Leaf	Mace-heads	Whetstone	Spindle-whirls			
88	25	17	70	14	26	8	28	40	2	6	13	16	1	23	19	11	9	10	7	132	157	33	44	131	127	34	34	34	133	78	45	123	110	119	
103	42	27	117	81	55	29	35		4			49	3	24						159	158	122		128	34	91		164		118		120	138		
	47	30	130	99	63	36	37		5			56	12											156	34	102		164		135		140	141		
	54	32	136	130	69	39	41		20			61	15											161	104	102						142	146		
	75	38	144	153	98	43	46					139	18											162	116	160									
	83	52	150			48	50					145	31												116	160									
	93	53				51	57																		121	163									
	96	67				58	59																		126	163									
	143	68				60	62																												
	151	76				64	65																												
	155	84				66	71																												
		87				72	73																												
		89				74	77																												
		94				79	80																												
		95				82	85																												
		101				86	90																												
		105				92	97																												
		111				100	106																												
		113				107	108																												
		114				109	112																												
		124				115	129																												
		125				134	137																												
						147	148																												
						149	152																												
						154																													
-2	-11	-22	-6	-5	-5	-49		-1	-4	-1	-1	-6	-6	-2	-1	-1	-1	-3	-1	-1	-2	-2	-2	-1	-5	-8	-8	-1	-3	-1	-3	-1		-8	

CHRONOLOGY

Both tombs contain two main groups of burials, separated from each other by considerable times. In Tomb 701 the earlier burials are represented by the Red Polished IV and the Black Slip II—III Wares. This layer is thereby dated to the end of Middle Cypriote II or the first stage of Middle Cypriote III. The rest of the pottery belongs to Late Cypriote III. It ought to be especially pointed out that the small Base-ring jug No. 26 is of a late type.

A corresponding division can be made in the other tomb. There the earlier stage is represented by the Red Polished III—IV Wares; the Red and the Black Slip Wares; the White Painted III—V Wares; the Plain White Hand-made Ware, and the Coarse Hand-made Ware. This pottery covers a period from about the end of Middle Cypriote II to the middle of Middle Cypriote III. To these epochs belong also all the finds of bronze, stone, and terracotta.

The rest of the contents of the tomb must be assigned to a fairly late stage of Late Cypriote III. Here, as in the first tomb, it may be observed that the small Base-ring pots Nos. 2, 4, 5, and 20 all are of the same late type.

E. S.

The necropolis at Kastros

INTRODUCTION

The locality of Kastros is situated below the plateau of Anastasia which limits the site to the South, and rises with an almost vertical rock wall, about 25 m. high, above the present level of the locality. To the North it is limited by a road running through the village in an east to west direction north of the main road; to the East by the valley Kremnos tou Kamilou, and to the West by the valley Kremnos tis Anastasias.

The bed-rock consists of the local limestone, and slopes to the North. The sloping rock is covered by a layer of cultivation earth kept in position by terrace walls. The soil is planted with olive trees (Fig. 65) and is covered with wheat, barley, potatoes etc. which grow in the fields among the trees.

In the Iron Age, when the rock slope was nearly bare, this site was occupied by a necropolis. The tombs were cut in the rock, as is usually in Cyprus. We excavated a part of the necropolis in 1927—1928. Excavations started in November 1927 when we had finished our work at Vrysi tou Barba (cf. p. 34) and continued until the middle of December. After a cessation during the winter-season, work was resumed in 1928, and went on from the beginning of March until the end of April. The site has never before been explored archaeologically but some of the tombs had been plundered in Byzantine times, as was shown by the condition of the finds. The tombs excavated are numbered 401—429.



Fig. 65. Lapithos. The necropolis at Kastros with Anastasia in the background.

TOMB 401 (Figs. 66; 67; 68: 1—4; 69: 1)

	SIZE			
	Length	Width	Depth	Height
Dromos	3.07	0.70	1.22	---
Stomion	0.27	0.66	—	0.90
Chamber	1.83	1.86	--	0.94

SHAPE

The dromos is a rather short and narrow passage, rectangular in plan; at the back, the walls taper upwards, the floor descending by a gradual slope to the door. The stomion is rectangular in plan and has a nearly flat roof and fills nearly the whole width of the dromos. It was closed by a door-packing forming a heavy mass of unworked middle-sized stones. The stomion opens on to the chamber to the right of its longitudinal axis, and its floor slopes down to that of the chamber by an oblique step. The chamber is nearly square in plan, with the side walls narrowing slightly towards the back, and rounded right front

corners. At the back of the chamber there is a round shaft, 0.22 m. deep, cut in the rock floor. The floor of the chamber is approximately horizontal. The roof is somewhat defaced by the weathering of the rock, but has been nearly horizontal too, sloping slightly towards the back wall.

STRATIFICATION

The filling of the dromos consisted of layers of homogeneous *chavara*, the lowermost mixed with plenty of potsherds towards the bottom. The layers in the chamber were composed of

- 1) Filling layers up to the roof of the chamber consisting of infiltrated earth, dromos-filling and weathered rock stuff.
- 2) A burial and culture stratum below this layer (second burial).
- 3) A burial and culture stratum at the bottom (first burial).

At the time of the second burial period some of the pots of the first burial were removed in order to make place for the new corpses and were piled up along the sides of the chamber on the top of the other pots there. Some of them have also come into floating by the infiltrated water and therefore the separation of finds and their attribution to the two burial periods is not certain in every case. The following numbers were found on the floor or slightly above it in the burial earth of Layer 3, and belong therefore certainly to the first burial period: Nos. 3—10, 13, 15, 17, 18, 24, 27, 32, 37, 50, 52—113 (for the levels see Obj. Reg.). The following numbers were found at the level of the second burial period and belong to that period: Nos. 11, 12, 30, 31, 33—36, 38—49, 51 (for the levels see Obj. Reg.). Of the other finds Nos. 1, 2, 14 were found floated up in the filling layers just below the roof and may therefore belong to any of the burial periods, but probably to the second period. Nos. 16, 19—23, 25, 26, 28, 29 were found piled up on the top of other pots and seem therefore to belong to the first burial period.

BURIALS

Remains of one body belonging to the first burial period were found in the shaft cut into the rock floor. This shaft contained a well preserved skull and some bones of the extremities (Skeleton I). From the position of these bones it can be concluded that they have been placed there when the body already was a skeleton. This was done at the time of the second burial period in order to make place for the new body then buried and at the same time some of the tomb gifts belonging to the body of the first burial period were piled up along the sides of the chamber, as stated above.

The remains of one body belonging to the second burial period were found in the middle of the chamber thus cleared away. The remains of the skeleton were rather scanty: the skull, the spinal column, and the upper extremities were missing, and only the femora were preserved (Skeleton II). From the position of these and the arrangement of the tomb-gifts on both sides of the empty space in the middle of the chamber, it seems clear that the body had been placed in a dorsal, outstretched position with the head towards the door.

FINDS (GROUPS: PL. XLI; TYPES: L. OF PL. II)

1. Black Slip II ovoid jug with base-ring. Fluted body and five parallel, grooved lines around shoulder. Neck and handle missing. Height 20.3. — 47.
2. White Painted II oval jug with pinched mouth; base-ring; handle from rim to shoulder. Encircling lines around neck, body, and base; lattice triangles on shoulder; a vertical wavy line on handle. Height 20.0. + 53.
3. Black Slip II ovoid jug with base-ring; concave neck; pinched mouth; handle from rim to shoulder. Three grooved lines around shoulder. Height 10.3. — 30.
4. Black Slip Painted plate with flat bottom and two horizontal, knobbed handles. Three lattice triangles meeting in a dot on base; encircling lines inside. Diam. 13.6. Floor.
5. White Painted I plate with flat base and two knobbed, horizontal handles. Decoration effaced. Diam. 23.0. — 26.
6. White Painted II ring-shaped vase with a basket-handle; bull's and goat's protomes, pomegranates, and miniature amphoriskoi standing on the ring. A frieze of vertical, framed latticed bands; crossed lines; framed band of hatched, contiguous triangles, framed bands of lattice lozenges interrupted by horizontal bands of framed, latticed rectangles and filled triangles with swastikas as filling-ornaments. The miniature pots are decorated with encircling bands; ladder-pattern on handles; painted details on protomes. Diam. 23.0. Floor.
7. Black Slip I—II jug, similar to No. 3. Height 15.0. Floor.
8. Black Slip II jug, shape as No. 3. Four or five parallel, grooved lines around shoulder. Height 12.0. — 29.
9. Black Slip II jug, similar to No. 3, but with wider, nearly cylindrical neck. Three parallel, grooved lines around shoulder. Height 13.8. — 27.
10. Black Slip II jug with base-ring, similar to No. 3, but with depressed ovoid body. Vertical, irregular, grooved lines on body. Height 10.8. — 25.
11. White Painted III amphoriskos with short stem; wide, concave neck, tapering upwards; handles from rim to shoulder. Decoration effaced. Height 13.8. — 19.
12. Red Slip Painted small, squat jug with flat base; funnel-shaped mouth; handle from neck to shoulder. Encircling lines around mouth, neck, and belly; swastikas on shoulder. Foreign ware. Height 7.0. — 19.
13. White Painted II oval amphora with base-ring; concave neck; flaring rim; horizontal handles on shoulder. Neck with broad, black bands and encircling lines between; encircling lines around shoulder, body, and base; lattice triangles on shoulder and transverse lines on rim. Height 27.3. — 25.
14. Black Slip II jug, shape as No. 3. Four or five grooved lines around shoulder. Height 22.7. + 30.
15. Black Slip Painted II plate with flat base and two horizontal handles. Four lattice triangles meeting in a dot on base; concentric circles inside. Diam. 17.8. — 29.
16. White Painted I plate with flat base and two horizontal handles. Concentric circles; encircling lines around rim; bottom decoration effaced. Diam. 24.2. — 13.
17. Black Slip II jug, shape as No. 1. Three grooved lines around shoulder. Neck missing. Height 13.6. — 27.
18. Black Slip II jug, shape as No. 10. Three grooved lines around shoulder. Height 12.6. — 30.
19. Black Slip II jug, shape as No. 3. One roughly made grooved line on shoulder. Height 11.8. — 17.
20. Black Slip II jug, shape as No. 10. Four grooved lines around shoulder. Height 12.8. — 13.
21. Red Slip Painted shallow bowl with short stem; profiled, raised rim; two horizontal handles. Encircling lines around rim, body, and base. Probably foreign ware. Diam. 23.0. — 13.
22. White Painted II oval jug with low foot; pinched mouth; handle from rim to shoulder. Encircling lines around neck, body, and base; three vertical bands of zigzag lines and dots bordered by parallel lines on shoulder; vertical wavy line on handle. Height 21.7. — 11.
23. Black Slip II jug, shape as No. 3, and decoration as No. 20. Height 22.0. — 1.
24. Red Slip Painted plate with base-ring and two vertical, profiled handles at rim. Encircling lines around rim and sides; concentric circles around base. Decoration nearly obliterated. Probably foreign ware. Mended in ancient times. Diam. 22.5. Floor.
25. White Painted I—II oval jug with base-ring; short, cylindrical neck; annular rim; handle from neck to shoulder. Encircling lines around rim, neck, body, and base, wavy line around neck; transverse lines on handle. Height 18.0. — 15.
26. Black Slip II oval jug with depressed ovoid body; rather wide neck, widening upwards; pinched mouth; handle from rim to shoulder. Fluted body and three grooved lines around shoulder. Height 14.0. — 21.
27. Black Slip II jug, shape as No. 3, and decoration as No. 26. Neck and handle missing. Height 9.4. — 29.
28. White Painted III open bowl with stemmed foot; nearly vertical sides; two horizontal handles. Encircling lines around rim, body, and base. Diam. 14.5. — 8.
29. Black Slip II jug, shape as No. 3, but without decoration of grooved lines. Height 25.0. — 23.
30. Black Slip II jug, shape as No. 10. Three to four grooved lines around shoulder. Height 14.3. — 21.
31. Black Slip II jug, shape as No. 3. Three grooved lines around shoulder. Height 9.6. — 22.
32. Black Slip II jug, shape as No. 3, and decoration as No. 31. Height 12.3. Floor.

33. Black Slip II jug, shape as No. 9. No decoration of grooved lines around shoulder. Height 10.9. — 18.
34. Black Slip II jug, shape as No. 3. Four grooved lines around shoulder. Neck missing. Height 11.8. — 21.
35. White Painted III oval amphora, with base-ring; slightly concave, narrow neck; horizontal handles on shoulder. Encircling lines around neck, shoulders, body, and base. Height 12.6. — 21.
36. White Painted II amphora with pear-shaped body; short stem; slightly concave neck; thick rim; handles from rim to shoulder. Encircling lines around rim, neck, and shoulder; groups of transverse lines on rim; vertical wavy lines on handles; on neck a metope decoration of a lozenge filled with lattice chequers and framed by vertical, parallel lines. One handle missing. Height 43.2. — 21.
37. White Painted II small amphora, shape as No. 36. Encircling lines around neck, body, and base; groups of transverse lines around rim; ladder-pattern on handles. Height 12.0. — 28.
38. Black-on-Red I (III) deep bowl, shape as No. 28, but with base-ring. Encircling lines around rim, body, and base. Diam. 11.6. — 23.
39. Bichrome II small barrel-shaped jug with widening neck and handle from neck to shoulder. Encircling lines around rim and neck; concentric circles around body. Height 7.6. — 21.
40. Black Slip II oval jug, shape as No. 10, but with wider neck. Three grooved lines around shoulder. Height 17.0. — 13.
41. Black Slip II oval jug, shape as No. 3. Four grooved lines around shoulder. Height 23.9. — 17.
42. Grey Polished hemispherical bowl with base-ring and two pierced, horizontal handles at rim. Diam. 9.0. — 19.
43. White Painted II oval amphora, shape as No. 13. Broad black bands and encircling lines between on neck; encircling lines on shoulder, and transverse lines around rim. Height 32.5. — 21.
44. Black Slip II oval jug, shape as No. 3. Three grooved lines around shoulder. Height 12.7. — 15.
45. Black Slip II oval jug, shape as No. 3. Four grooved lines around shoulder. Height 22.3. — 17.
46. Black Slip II oval jug, similar to No. 10, and decoration as No. 45. Height 14.2. — 10.
47. Plain White I globular jug with base-ring; ridge around base of neck; concave neck; annular rim; high handle from neck to shoulder. Height 24.0. — 14.
48. Black Slip II oval jug, shape as No. 3, and decoration as No. 44. Neck missing. Height 15.4. — 18.
49. White Painted II oval jug with low foot; cylindrical neck; pinched mouth; handle from rim to shoulder. Encircling lines around neck and body; lattice triangles on shoulder; ladder-pattern on handle; lower part of body covered with black paint. Height 14.8. — 20.
50. Black Slip I oval jug with base-ring, short, concave neck; pinched mouth; handle from rim to shoulder. Body decorated with carefully grooved, vertical lines and three grooved lines around shoulder. Height 21.0. — 25.
51. Black Slip II oval jug, shape as No. 10, and decoration as No. 44. Height 15.3. — 21.
52. Black Slip II oval jug, shape as No. 9, and decoration as No. 44. Height 13.9. — 27.
53. White Painted I spherical jug with narrow, short neck; collar-shaped mouth; handle from neck to shoulder. Encircling lines around neck; four groups of concentric circles around body; ladder-pattern on handle. Height 10.0. Floor.
54. Black Slip II oval jug, shape as No. 3, and decoration as No. 44. Height 10.6. Floor.
55. White Painted I shallow bowl with flat base and two horizontal handles. Encircling lines around rim and bottom; a spiral inside and a maltese cross on base; two inverted lattice triangles on body. Diam. 9.9. Floor.
56. White Painted I plate with flat base and two horizontal handles. Concentric circles inside; bottom decoration effaced. Diam. 7.7. In No. 57.
57. Bichrome I—II plate with flat base and two horizontal handles. Encircling lines; concentric circles inside and four lattice triangles meeting in concentric circles on base. Handles missing. Diam. 21.9. Floor.
58. Seven flat, circular beads of white glass-paste. Traces of blue glaze still visible. One bead broken. Diam. c. 0.75. Floor.
59. Bronze fibula with beaded, angular bow. Pin and catch missing. Length 3.95. Floor.
60. Plain, circular, somewhat concave bronze disc with a hole pierced in the centre. Edge chipped. Diam. 3.5. Floor.
61. Black Slip II oval amphoriskos with low foot; narrow, splaying neck; handles from neck to shoulder. Fluted body and three grooved lines around shoulder. One handle and part of neck missing. Height 9.8. Floor.
62. Black Slip II amphoriskos, shape and decoration as No. 61. Height 11.1. Floor.
63. Black Slip I—II oval jug with base-ring; slightly concave neck; pinched mouth; handle from rim to shoulder. Fluted body and three grooved lines around shoulder. Height 15.3. Floor.
64. Black Slip I oval jug, similar to No. 50. Two grooved lines around shoulder. Height 15.3. Floor.
65. Black Slip I—II oval jug, shape and decoration as No. 63. Height 16.7. Floor.
66. Plain White II oval jug, with flat base; narrow, cylindrical neck; annular rim; handle from neck to shoulder. Height 15.5. Floor.
67. Black Slip I—II oval jug, shape and decoration as No. 63. Height 11.5. Floor.
68. Black Slip II depressed oval jug. Decoration as No. 63. Neck missing. Height 14.1. Floor.
69. Black Slip II amphoriskos, as No. 61. Height 10.7. Floor.

70. Black-on-Red I (III) oval jug with base-ring; pinched mouth; handle from rim to shoulder. Encircling lines around rim, neck, body, and base; zigzag band on handle. Height 19.3. Floor.
71. Black Slip II jug, as No. 26. Height 14.7. Floor.
72. Black Slip II jug, shape as No. 26. Four grooved lines around shoulder. Height 14.9. Floor.
73. Black Slip II jug, as No. 26. Height 13.7. Floor.
74. Black-on-Red I (III) jug, as No. 70. Height 19.6. Floor.
75. Black Slip II oval jug, as No. 3, and decoration as No. 72. Height 21.5. Floor.
76. Black Slip I—II oval jug, shape as No. 63, and decoration as No. 72. Neck missing. Height 14.1. Floor.
77. Black Slip Painted plate with small base-ring and two horizontal, knobbed handles. Fluted body. A star of six lattice triangles and concentric circles on base; concentric circles inside. Diam. 17.1. Floor.
78. White Painted II plate with flat base and two horizontal handles. Concentric circles with a central dot inside; encircling lines and four lattice triangles meeting in large, central dot on base. Diam. 14.6. Floor.
79. White Painted II plate, as No. 78. Diam. 15.7. Floor.
80. Black Slip II amphoriskos, as No. 61, but with depressed oval body. Height 11.0. Floor.
81. Black Slip II oval jug, as No. 63, and decoration as No. 72. Height 22.0. Floor.
82. Black Slip I—II oval jug, shape as No. 63, and decoration as No. 72. Upper part of neck missing. Height 22.5. Floor.
83. White Painted II oval hydria with base-ring; neck tapering upwards; two handles on shoulder and a third handle from rim to shoulder. Encircling lines around neck, shoulder, body, and base; a "collar" of transverse lines around neck; vertical zigzag line on handle; two sweeping strokes below it. Mouth missing. Height 31.4. Floor.
84. White Painted II plate, as No. 78. Diam. 25.0. Put together of fragments from first burial layer.
85. White Painted II plate, as No. 78, but without handles. Diam. 16.0. As No. 84.
86. White Painted II plate, shape as No. 85. Concentric circles; encircling lines around the rim and four lattice triangles meeting in a dot on base. Diam. 15.5. As No. 84.
87. White Painted I plate with flat base and two knobbed, horizontal handles. Concentric circles inside; encircling lines around rim and four lattice triangles radiating from an inscribed wheel on base. Diam. 16.4. As No. 84.
88. White Painted I plate, as No. 78. Concentric circles inside; encircling lines around rim; a band of lattice lozenges bordered by parallel lines and flanked by three lattice triangles on base. Diam. 29.2. As No. 84.
89. White Painted I plate, as No. 78, and decoration as No. 88; bottom decoration effaced. Diam. 18.0. As No. 84.
90. White Painted I plate, shape as No. 78. Concentric circles inside; encircling lines around rim and four lattice triangles meeting on base. Centre of base missing. Diam. 16.4. As No. 84.
91. Bichrome I plate with base-ring and two horizontal handles. Encircling lines around rim; concentric circles on base and around it. Diam. 16.9. As No. 84.
92. White Painted I—II open bowl with short stem; nearly vertical sides; two horizontal handles. Encircling lines round rim, body, and base. Diam. 14.2. As No. 84.
93. White Painted I—II bowl, as No. 92. Diam. 11.3. As No. 84.
94. White Painted II bowl, similar to No. 92, but of rather angular outline, and with wide, stemmed foot. Encircling lines; metopes of lattice rectangles bordered by parallel lines round body. Diam. 15.4. As No. 84.
95. White Painted III deep bowl with base-ring; angular outline; straight, splaying sides; two horizontal handles. Encircling lines round rim, body, and base. Diam. 12.0. As No. 84.
96. White Painted III bowl, as No. 95. Diam. 12.0. As No. 84.
97. White Painted III bowl, as No. 95. Diam. 12.0. As No. 84.
98. White Painted II open large bowl with stemmed, wide foot; angular outline; two horizontal handles. Encircling lines round rim, body, base, and handles; a metope decoration of lattice rectangles bordered by parallel lines around body. Diam. 26.2. As No. 84.
99. White Painted I shallow bowl with flat base and two horizontal handles. Encircling lines round rim and base; a spiral inside; a maltese cross on base. Diam. 10.5. As No. 84.
100. White Painted I pear-shaped jug with base-ring and tubular spout on shoulder. Encircling lines around neck and body; the lower part covered with black paint. Upper part missing. Height 9.8. As No. 84.
101. White Painted I—II open large bowl with stemmed foot; curved outline; two horizontal handles. Encircling lines and bands and metope decoration of framed squares filled with lattice chequers and flanked by bands of vertical lines and lattice lozenges around body. Diam. 24.7. As No. 84.
102. White Painted II ovoid amphora with base-ring; concave neck; flaring rim; two horizontal handles on shoulders. On neck broad, black bands and encircling lines between; encircling lines on shoulders, body, and base; lattice triangles on shoulder, transverse lines around rim. Height 32.5. As No. 84.
103. White Painted II ovoid amphora, as No. 102. Height 32.5. As No. 84.
104. White Painted I—II large, oval amphora with base-ring; short, concave neck; swollen rim; horizontal handles on shoulders. Decoration as No. 102, but with pairs of lattice triangles around shoulder. Height 58.9. As No. 84.

105. White Painted I ring-shaped vase with basket-handle; bull's protome, birds, and miniature amphoriskoi standing on the ring. A frieze of lattice lozenges around ring and a zigzag band on handle. The miniature pots are decorated with encircling lines and bands, latticed bands, bands of zigzag lines, and lattice triangles. Diam. 24.2. As No. 84.
106. White Painted II tripod. Encircling lines and strokes around the edges of legs. Height 18.9. As No. 84.
107. Black Slip II ovoid jug, shape as No. 10, and decoration as No. 45. Height 12.0. As No. 84.
108. Black Slip II amphoriskos with wide, short, stemmed foot; depressed pyriform body; concave neck; handles from rim to shoulder. A decoration of irregular, grooved lines on body. Height 19.6. As No. 84.
109. Black Slip Bichrome plate with base-ring and two knobbed, horizontal handles. Concentric circles inside; filled triangles and bichrome, concentric circles on base. Diam. 28.0. As No. 84.
110. White Painted I plate with flat base and two horizontal handles. Concentric circles around rim; four lattice triangles meeting in concentric circles. on base; encircling lines and bands around base. Diam. 22.5. As No. 84.
111. Coarse ovoid jug with base-ring; wide mouth; handle from rim to shoulder. Height 14.0. As No. 84.
112. Coarse ovoid amphora with base-ring; wide mouth; handles from rim to shoulder. Height 31.2. As No. 84.
113. White Painted I—II open bowl with low foot; softly curved outline; handle from rim to body. Encircling lines and bands. Diam. 14.5. As No. 84.

Summing up the classification given in the Object Register and the stratigraphical data, we obtain the following diagram:

		P o t t e r y															Bronze		Glass Paste						
		Wh. P. I	Wh. P. I-II	Wh. P. II	Wh. P. III	Bichr. I	Bichr. I-II	Bichr. II	Bl. Sl. P. I-II	Bl. Sl. Bichr.	Bl. Sl. I	Bl. Sl. I-II	Bl. Sl. II	Bl-on-R. I (III)	Grey Pol.	Pl. Wh. II	Coarse Ware	R. Sl. P. (Foreign Ware)	Fibula	Disc	Read				
1st burial period	5. 53	92	6, 13	95	91	57	4	109	50	7	3.	8	70	66	111	24	59	60	58						
	55. 56	93	37. 78	96			15		64	63	9.	10	74		112										
	87. 88	101	79. 83	97			77			65	17.	18													
	89. 90	104	84. 85							67	27.	32													
	99. 100	113	86. 94							76	52.	54													
	105, 110		98, 102							82	61.	62													
			103. 106								68.	69													
											71.	72													
											73.	75													
											80.	81													
										107.	108														
										-12	-5	-14	-3	-1	-1	-3	-1	-2	-6	-22	-2	-1	-1	-1	-1
2nd burial period			36. 43. 49	11		39							30. 31	38	42	47		12							
				35									33. 34												
													40. 41												
													44. 45												
													46. 48												
												51													
			-3	-2		-1							-11	-1	-1	-1		-1							
Uncertain burial period	16	25	2. 22	28									1. 14				21								
													19. 20												
													23. 26												
													29												
												-7													

CHRONOLOGY

As shown by the diagram the first burial period is represented by pottery of Types I and II, mixed with stray specimens of Type III: White Painted I—III, Bichrome I—II, Black Slip Painted I—II, Bichrome Black Slip, Black Slip I—II, Black-on-Red I (III),



Fig. 66. Lapithos. Tomb 401, dromos.

Fig. 67. Lapithos. Tomb 401. Interior view of a part of finds *in situ*.

and Plain White I. The specimens of Type II are in majority; those of Type I are generally late in style and most of them are plates which, as a rule, are more constant in type than more complicate shapes. The foreign Red Slip Painted pottery is noteworthy. This mixture of Types I—III indicates that the burial period comprises a considerable time. The specimens of Type III show that it lasted until the beginning of Cypro-Geometric III, but the amount of pottery of Type I assigns the beginning of the period to the end of Cypro-Geometric II.

The second burial period is represented by pottery of Type II mixed with a few specimens of Type III: White Painted II—III, Black Slip II, Black-on-Red I (III), Grey Polished, and a single specimen of Plain White I Ware, from which it can be assigned to the early part of Cypro-Geometric III.

TOMB 402 (Figs. 68: 5—7; 69: 2)

	Length	Width	Depth	Height
Dromos	2.75	0.75	1.98	--
Stomion	—	0.75	—	0.98
Chamber	1.95	1.63	—	1.12

SHAPE

The dromos is a short, narrow passage, widening towards the back end, with walls tapering upwards especially at the back end, the floor sloping steeply to the door. The door has a vaulted roof and occupies the whole width of the dromos. It was closed by a door-packing, the same as that of Tomb 401. The door opens on to the chamber somewhat to the right of its longitudinal axis, and the floor of the dromos descends to that of the cham-

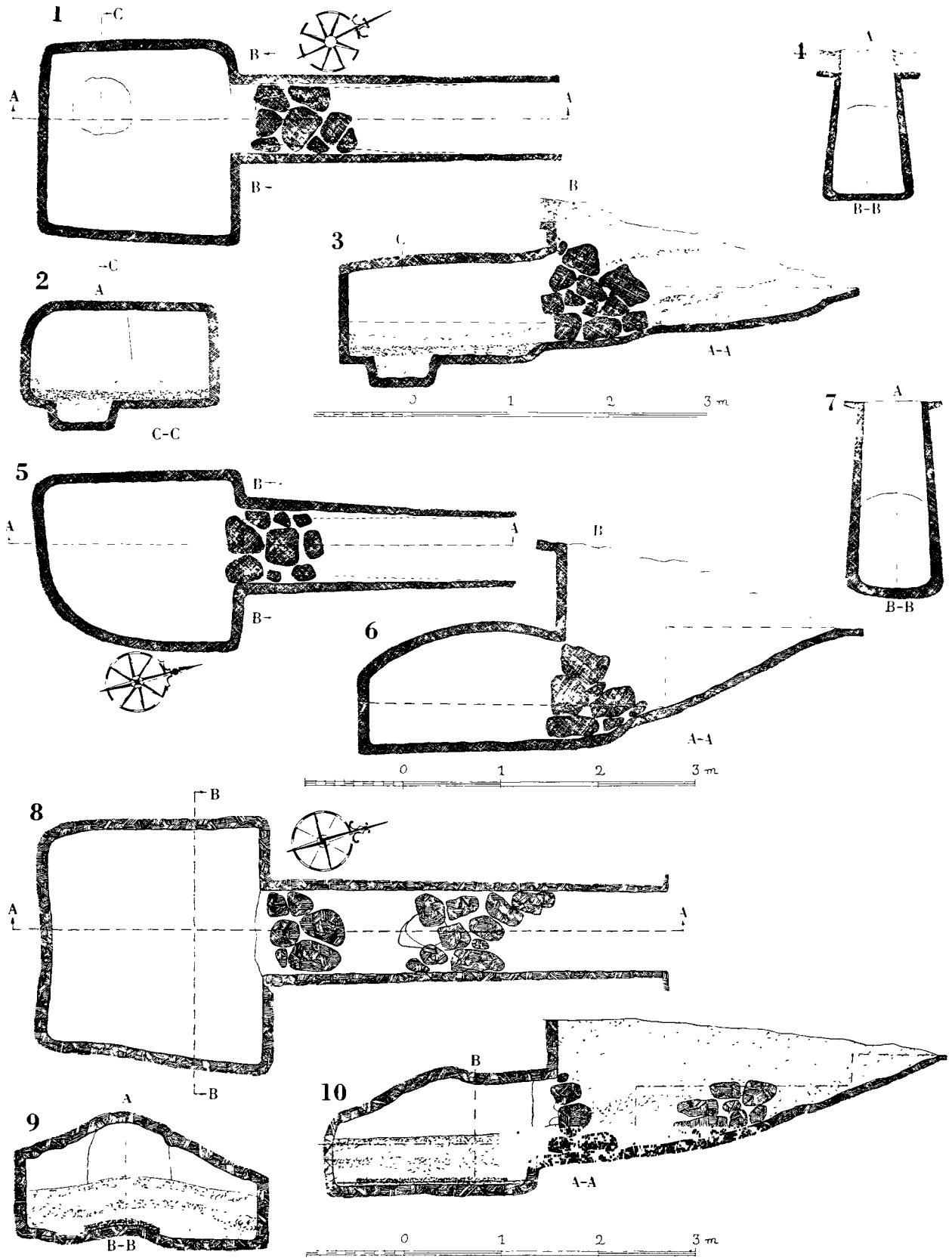

Fig. 68. Lapithos. Tomb 401, Plan (1); Sections C-C, A-A, B-B (2-4). Tomb 402, Plan (5); Sections A-A, B-B (6, 7). Tomb 403, Plan (8); Sections B-B, A-A (9, 10).

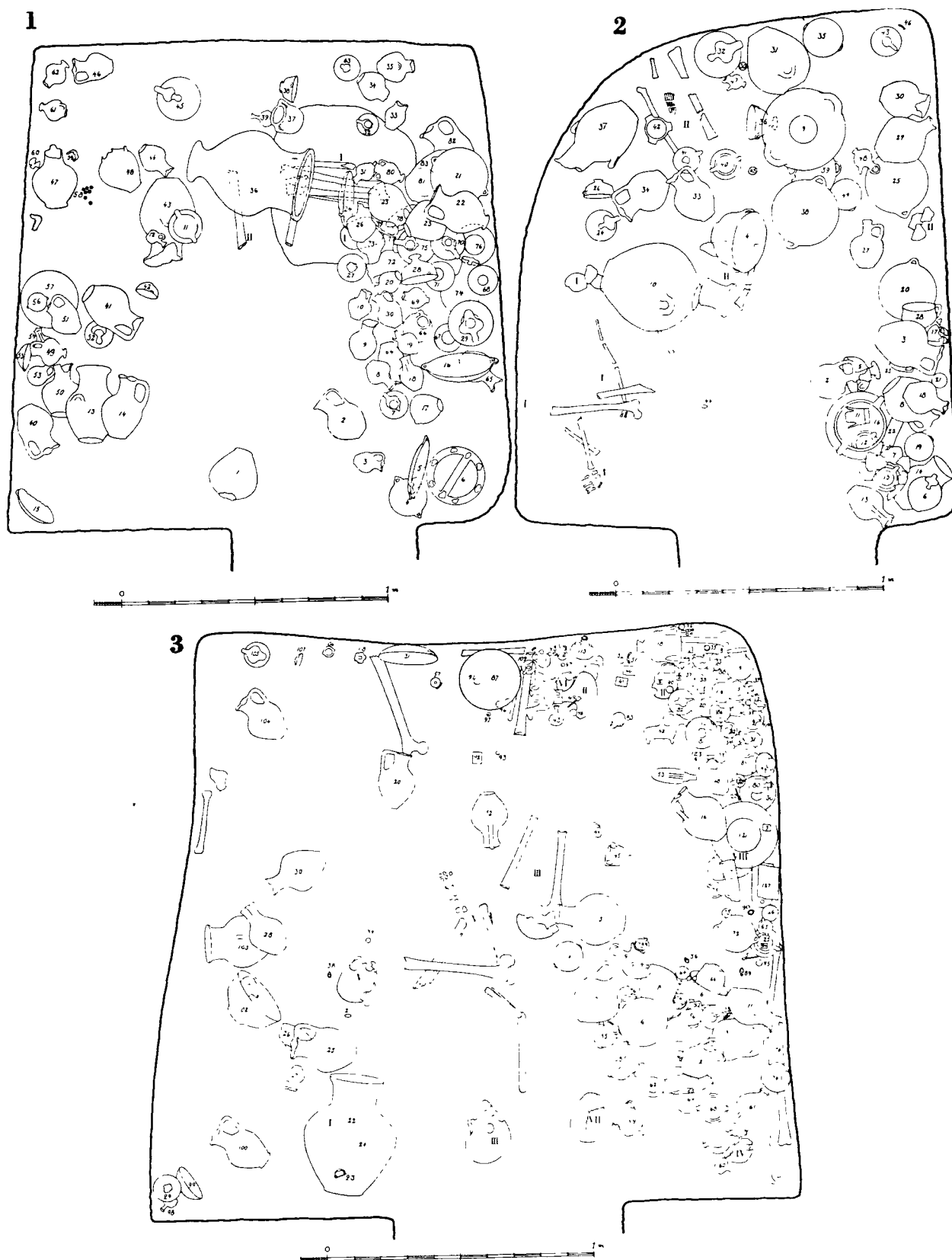

Fig. 69. Lapithos. Tomb 401, Finds *in situ* (1). Tomb 402, Finds *in situ* (2).
Tomb 403, Finds *in situ* (3).

ber by a gradual slope. The chamber is of similar plan to that of Tomb 401, but the south-eastern rock wall is rounded. The floor of the chamber slopes slightly towards the back wall and the roof, which has partly fallen in, is curved.

STRATIFICATION

The filling of the dromos consisted of undisturbed layers of homogeneous *chavara*. The layers in the chamber were composed of a burial and culture stratum at the bottom and a covering layer of rock debris from the destroyed part of the roof.

All the objects belong to one burial period and were found on the floor.

BURIALS

Remains of two skeletons were found, one along the left wall of the chamber (Skeleton I), and the other near the back of the chamber (Skeleton II). Of the first skeleton, part of the skull, and the upper and lower extremities were preserved in such a position, that it could be concluded that the body had been placed on its right side in a slightly contracted position. Of the second skeleton, parts of the skull and the upper and lower extremities were preserved as well, but were not found *in situ*: fragments of the skull were found near the right long wall and scattered portions of the extremities in disorder, in the middle of the back part of the chamber. Probably the body was removed at the time of the burial of the body No. 1; which, consequently, represents the last burial of the tomb. In connection with the second skeleton a spindle-whirl of stone (No. 50) was found, indicating that the body was female.

The tomb-gifts, in pots, were placed along the right side wall and near the back of the chamber.

FINDS (GROUPS: PL. XLII, I, 2; TYPES: L. OF PL. II)

- | | |
|---|--|
| <p>1. Fragment of straight, thin bronze pin. Length 1.5. Floor.</p> <p>2. White Painted II spherical jug with conical, splaying mouth; two handles from neck to shoulder. A maltese cross inscribed in concentric circles, from which radiate framed zigzag bands and fringed lines to a periphery of concentric circles on both sides of body; encircling lines on mouth; ladder-pattern on handle. Height 21.2. Floor.</p> <p>3. Black-on-Red I (III) oval jug with base-ring; slightly concave neck; very pinched mouth; handle from rim to shoulder. A decoration of vertical, grooved lines on body; horizontal, grooved lines round shoulder; encircling lines round rim, neck, shoulder, belly, and base; a bird's eye at mouth and a zigzag line along handle. Height 23.9. Floor.</p> <p>4. Red Slip I (III) deep, open bowl with base-ring; angular outline; two horizontal, upright handles. Four to five grooved lines around rim. Diam. 23.0. Floor.</p> <p>5. White Painted III bowl with short, stemmed foot, angular outline; nearly vertical sides; two horizontal</p> | <p>handles. Encircling bands around rim, body, and base. Diam. 15.0. Floor.</p> <p>6. Black Slip I jug with low foot; globular body; concave neck; pinched mouth; handle from rim to shoulder. A decoration of grooved lines on body. Height 19.2. Floor.</p> <p>7. White Painted I plate with flat base and two horizontal handles. Encircling lines and concentric circles inside; four lattice triangles meeting in a circle on base. Diam. 23.2. Floor.</p> <p>8. White Painted II depressed oval jug with base-ring; concave neck; pinched mouth; handle from rim to shoulder. Encircling lines and bands round rim, neck, shoulder, belly, and base; vertical zigzag band on handle. Height 22.0. Floor.</p> <p>9. Bichrome II ovoid amphora with base-ring; concave neck; swollen rim; horizontal handles on shoulder. Neck covered with black paint; encircling lines and bands round shoulder and belly; vertical lines and lattice triangles on shoulder. Height 44.0. Floor.</p> <p>10. Bichrome III ovoid amphora with base-ring; slightly</p> |
|---|--|

- concave neck, tapering upwards; swollen, splaying rim; horizontal handles on shoulder. Encircling bichrome bands and lines around shoulder, belly, and base; on shoulder a framed lattice triangle with a filled lozenge on top; neck decorated with encircling lines and bands. Height 45.2. Floor.
11. White Painted II tripod with concave neck and annular rim. Encircling lines around rim, body, and legs; grooved lines round body and vertical bands of lattice lozenges framed by parallel lines on legs. Height 8.4. Floor.
 12. Black Slip I amphoriskos with short foot; hemispherical body; concave, wide neck; flat rim; handles from rim to shoulder. Fluted body and three horizontal, grooved lines around shoulder. Height 12.4. Floor.
 13. Black Slip II depressed ovoid jug with base-ring; rather cylindrical neck, slightly widening upwards; pinched mouth; handle from rim to body. Fluted body; three horizontal, grooved lines on shoulder. Height 18.2. Floor.
 14. Coarse oval jug with flat base; wide, cylindrical neck; handle from rim to shoulder. Height 22.6. Floor.
 15. Black Slip II amphoriskos, similar to No. 12, but with depressed ovoid body and cylindrical neck. One handle missing. Height 13.0. Floor.
 16. Coarse biconical crater with round base; no neck; raised, profiled rim; handles from rim to shoulder. Height 16.5. Floor.
 17. White Painted II jug. Fragmentary. Decoration nearly effaced. Floor.
 18. Black Slip I jug with base-ring; globular body; concave neck; pinched mouth; handle from rim to shoulder. Fluted body; three horizontal, grooved lines on shoulder. Height 16.7. Floor.
 19. White Painted II open bowl with short, stemmed foot; angular outline; two horizontal handles. Encircling bands; a metope decoration of lattice rectangles and triangles framed by parallel lines around body. Height 7.3. Floor.
 20. White Painted I plate, as No. 7. Diam. 22.0. Floor.
 21. Plain White III spherical pot with cylindrical, short neck; punctured and incised decoration of vertical lines. Diam. 5.0. Floor.
 22. White Painted II animal-shaped vase with four legs and basket-handle on back; bands of lattice lozenges framed by parallel lines on body; a "dog-tooth" ornament in front. Length 15.0. Floor.
 23. Plain White I bobbin-shaped vase with pinched mouth and handle from rim to shoulder. Height 9.2. Floor.
 24. Black Slip I jug, shape as No. 18. No horizontal, grooved lines on shoulder. Height 15.4. Floor.
 25. Bichrome II plate with flat base and two horizontal handles. Concentric circles inside, encircling lines and bands around base; lattice triangles and radiating lines meeting in concentric circles on base. Diam. 23.9. Floor.
 26. White Painted III open bowl with base-ring; angular outline; nearly straight, splaying sides; two horizontal handles. Encircling lines. Diam. 12.0. Floor.
 27. Plain White III oval jug with flat base; narrow, cylindrical neck; annular rim; handle from neck to shoulder. Height 17.0. Floor.
 28. White Painted I open bowl with low foot; softly curved outline; handle from rim to shoulder. Encircling lines. Height 8.7. Floor.
 29. Plain White II biconical jug with base-ring; short, upwards tapering neck; a ridge round base of neck; annular rim; handle from neck to shoulder. Height 23.0. Floor.
 30. White Painted II ovoid jug with base-ring; cylindrical neck; a basket-handle and spout. Neck decorated with black band and encircling lines; encircling lines and bands round belly and base; three lattice triangles on shoulder. Spout and neck damaged; handle missing. Height 17.5. Floor.
 31. White Painted II ovoid amphora with two horizontal, handles on shoulder. Encircling bands around shoulder, belly, and base; lattice triangles and vertical lines symmetrically grouped around shoulder. Neck missing. Height 24.5. Floor.
 32. Black Slip II jug, shape as No. 13. Four grooved lines around shoulder. Height 24.0. Floor.
 33. White Painted II oval jug with base-ring; cylindrical neck; pinched mouth; handle from rim to shoulder. Encircling lines and bands around neck and belly; arc-shaped lines forming a star ornament around shoulder; ladder-pattern on handle. Height 22.0. Floor.
 34. Black Slip II jug, as No. 13. Height 20.0. Floor.
 35. White Painted III bowl, as No. 5. Diam. 15.0. Floor.
 36. Black-on-Red I (III) bowl, shape similar to No. 5, but with a ridge below rim. Encircling lines around rim, body, and base. Diam. 13.5. Floor.
 37. White Painted II oval amphora with slightly concave neck; splaying rim, two horizontal handles on shoulder. Encircling lines and bands round shoulder, belly, and base; neck decorated with broad black bands and encircling lines between; on shoulder framed lattice triangles with a filled lozenge on top. Height 33.0. Floor.
 38. White Painted I plate, as No. 7. Diam. 25.0. Floor.
 39. White Painted I—II plate, similar to No. 7, but with large encircled dot on base. Diam. 24.0. Floor.
 40. Black Slip II amphoriskos, as No. 15. Height 14.0. Floor.
 41. White Painted II jug with low foot, slightly concave neck; spout and basket-handle. Encircling lines and bands round rim, neck, shoulder, belly, and base. Handle missing. Height 16.0. Floor.
 42. White Painted II tripod with concave neck and annular rim. Encircling lines round rim, body, and legs. Height 11.0. Floor.
 43. Plain White II globular jug with low foot; neck tapering upwards; annular rim; handle from neck to shoulder. Height 17.0. Floor.
 44. Roughly biconical spindle-whirl of black steatite. Length 2.3. Floor.

45. Thin disc of bronze, with a hole pierced in the centre
Diam. 3.5. Floor.
46. Fragments of beaded bow of bronze fibula. Length
3.0. Floor.
47. White Painted I jug with low foot; globular body; con-
cave neck, spout on shoulder; basket-handle. Decora-
tion as No. 41. Height 9.5. Floor.
48. White Painted I jug, shape as No. 47, decoration as
No. 33. Height 10.0. Floor.
49. White Painted II open bowl, shape as No. 19. Encirc-
ling bands; metope decoration of crosses and latticed
bands around body. Diam. 12.0. Floor.
50. Conical spindle-whirl of black steatite with a central
hole. Diam 3.0. Floor.

Summing up the classification given in the Object Register, we obtain the following diagram:

P o t t e r y														B r o n z e			Stone
Wh. P. I	Wh. P. I-II	Wh. P. II	Wh. P. III	Bichr. II	Bichr. III	Bl.-on-R. I (III)	Bl. Sl. I	Bl. Sl. II	R. Sl. I (III)	Pl. Wh. I	Pl. Wh. II	Pl. Wh. III	Coarse W.	Pin	Fibula	Disc	Spindle-whirl
7	39	2. 8	5	9	10	3	6	13	4	23	29	21	14	1	46	45	44
26		11. 17	26	25		36	12	15			43	27	16				50
28		19. 22	35				18	32									
38		30. 31					24	34									
47		33. 37						40									
48		41. 42															
		49															
-6	-1	-13	-3	-2	-1	-2	-4	-5	-1	-1	-2	-2	-2	-1	-1	-1	-2

CHRONOLOGY

We see thus that the pottery comprises a few survivals of Type I of which the painted specimens for the most part are plates (cf. above p. 179): White Painted I, Black Slip I, and Plain White I; the majority is of Type II and some early specimens of Type III: White Painted II—III, Bichrome II—III, Black-on Red I (III), Black Slip II, Red Slip I (III), Plain White II—III, which assign the tomb to the beginning of Cypro-Geometric III.

TOMB 403 (Figs. 68: 8—10; 69: 3; 70)

SIZE

	Length	Width	Depth	Height
Dromos	3.88	0.86	1.36	—
Stomion	0.26	0.86	—	0.80
Chamber	2.18	2.42	—	1.04

SHAPE

The dromos is a narrow, rather short passage, approximately rectangular in plan with walls narrowing upwards slightly; the floor descends by a gradual slope to the door. The stomion has a vaulted roof and occupies the whole width of the dromos. It was closed by

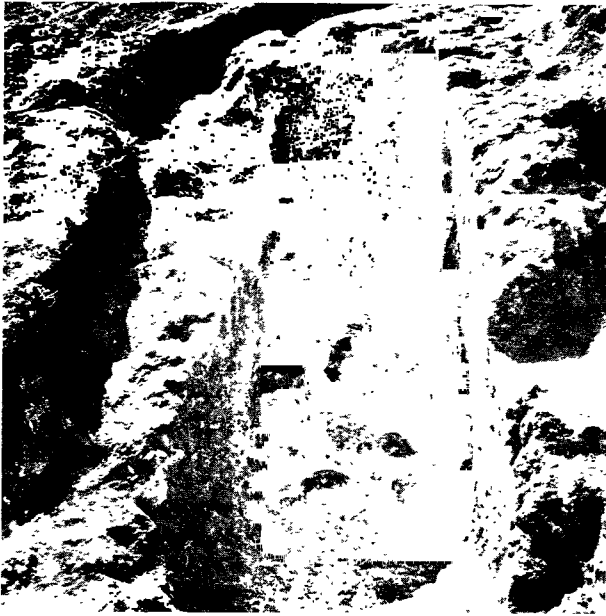

Fig. 70. Lapithos. Tomb 403, dromos.



Fig. 71. Lapithos. Tombs 404-405.

the usual packing of rough stones. The door opens on to the chamber slightly to the right of its longitudinal axis, and the floor of the stomion descends to that of the chamber by a vertical step. The chamber is roughly trapezoid in shape, with the side walls narrowing slightly towards the back wall, and rounded corners. Its floor and roof slope towards the back and the left side wall; a part of the middle of the roof has fallen in.

STRATIFICATION

The dromos was filled with three layers of *chavara* mixed with potsherds increasing in number towards the bottom. In the middle of the dromos there was an accumulation of rough stones similar to those closing the door. This mass of stones rested on the rock floor of the dromos and reached the original line of the surface. The layers in the chamber were composed of three successive burial layers, of which the lowermost rested on the rock floor, and each with a covering layer of infiltrated mud. Though the position of the skeletons and the tomb-gifts have, to some extent, been disturbed by the successive burials and the action of water it is still possible to assign the remains of the bodies and the tomb-gifts to their different burial layers. Remains of eight skeletons in all were observed. Skeletons Nos. V, VI, and VII belong to the first burial period together with the finds Nos. 36, 38, 39, 44, 45, 47—52, 55, 57, 60, 68, 71—73, 78—79, 91, 96—108, 121—124, 127—140, and most of the Nos. 141 to 153, which were put together from fragments of pottery found in the filling of the dromos and thrown out there at the later burials. Skeletons Nos. I, III, and VIII together with the finds Nos. 58, 59, 61—67, 69, 70, 74, 75, 77, 83, 85—88, 109—120, 125, 126, belong to the second burial period. Skeletons Nos. II and IV, together with the remainder of the finds, belong to the third burial period. The finds of the first

burial period were found on the floor or in the culture earth of this period up to — 30. The finds of the second burial period were found at a level varying between — 28 and — 18, and the finds of the third burial period at a level varying between — 15 and — 6 (for the levels see Obj. Reg.).

BURIALS

Of Skeleton No. V parts of the lower extremities and the skull were preserved. The body had been placed in the middle of the chamber apparently in an outstretched or slightly squeezed position with the head towards the door. It did not rest on the floor as the other bodies of this burial period, but on an artificially constructed bed of hard clay mixed with carbonized matter. It had had gold earrings in the ears, of which one (No 38) was found not far from the skull, but the other one (No. 36) far away in the western part of the chamber, evidently swept away at the later burials. Spindle-whirls (Nos. 21 and 39) were also found in connection with this skeleton, indicating that the corpse had been that of a female. Of Skeleton No. VI fragments of the skull and a few bones were found along the back wall of the chamber. Nothing certain can be said as to its position. The body was that of a female, which is proved by the jewelry associated with it: A circular gold plaque (No. 57), which once was worn as a pendant on a string around the neck, as shown by archaic statues. Scanty remains of Skeleton No. VII were found along the right side wall of the chamber. They were not found in their original position, and apparently had been removed at the time of the later burials. Of the skeletal remains of the second burial period, Skeleton No. I was found packed into the amphora No. 22, the level of which was + 30 cm. above the floor-level, i. e. that of the third burial stratum, and so it can be concluded that the corpse had belonged to the second burial period and had been removed and packed into the amphora in order to make room for the new bodies then buried. Skeleton No. III was found in the middle of the tomb, above Skeleton No. V. The skull, and parts of the upper and lower extremities were preserved, and lay approximately in their original position (the left femur has been somewhat removed) indicating that the body had been placed in a dorsal, outstretched position with the head near the door. The skull of Skeleton No. VIII was found by the right side wall of the chamber, just below the feet of Skeleton No. IV, but of the bones only a few insignificant fragments were preserved. Of the skeletal remains of the third burial period, Skeleton No. II was found along the back wall of the chamber with the head by the right side wall. The body had probably been placed in an outstretched dorsal position, but the bones were not all found *in situ* (e. g. a femur was found close to the head). The body was that of a female and it had been richly adorned with gold ornaments: five gold plaques with figural representations (Nos. 1, 3, 40, 41, 92) and circular mountings (Nos. 4, 33, 46, 93) with pierced holes for fastening them, probably decorated a head-gear of the same type of cap as shown by archaic sculptures and the figures on the Idalion bronze bowl (cf. Ohnefalsch-Richter, *Kypros, die Bibel und Homer*, Pl. CXXX: 1). Earrings of gold completed the list of jewelry. The dress had been fastened by a bronze fibula, and a bronze pin with a head of rock-crystal. The remains of Skeleton

No. IV were found along the right side wall. The skull, parts of the upper extremities and the femora were preserved, but were not in their original position. This body, too, was that of a female, adorned with earrings Nos. 32 and 89, and a gold plaque and the mountings Nos. 37, 94 and 95 had once decorated a head-gear of the same kind as that of Skeleton No. II. A bone pin with a head in the shape of a pomegranate (No. 5) was used for fastening the dress.

FINDS (GROUPS: PLS. XLII, 3, 4, XLIII, XLIV, I; TYPES: L. OF PL. II)

1. Rectangular gold plaque with rolled-up or folded edges for bronze pins to fit into; pierced hole in each corner. The plaque is decorated with a female head in pressed and enchased work. The head is frontal and symmetrical, with a Syrian hair-dress; almond-shaped eyes; large nose; small, straight mouth; marked eyebrows, eyelids, and lips. The face is almost triangular in shape. A large pendant of a necklace is visible on neck. The representation is slightly damaged; right bottom corner restored. Some bronze fragments are still preserved along right long side. Length 4.3. — 10.
2. Two square gold plaques ornamented with a rosette in enchased work. Repaired. Length 2.5. — 8.
3. Gold plaque, as No. 1. Restored at left bottom corner. Length 4.0. — 8.
4. Circular, convex mounting of thin gold, with two holes pierced near edge. Chipped. Diam. 2.4. — 6.
5. Straight pin of ivory with a head in shape of pomegranate; groups of grooved lines round pin. Not complete. Length 5.9. — 7.
6. Red Slip I (III) wide bowl with base-ring; angular outline; nearly vertical sides; two horizontal handles. Encircling grooved lines round rim. Diam. 18.3. — 10.
7. Black Slip II oval jug with base-ring; pinched mouth; handle from rim to shoulder. Grooved lines round shoulder. Height 24.5. — 8.
8. Black-on-Red I (III) depressed ovoid jug with base-ring; narrow, slightly concave neck; pinched mouth with rim bent inwards; handle from rim to shoulder. Encircling lines round neck and shoulder; eye-ornament below rim; framed zigzag line on handle. Height 21.5. — 10.
9. White Painted III oval jug with raised base; slightly concave neck; spout on shoulder; basket-handle. Encircling bands on shoulder and neck; zigzag line on spout; ladder-pattern on handle. Height 16.8. — 13.
10. Black-on-Red I (III) depressed spherical jug with flat base; narrow neck with handle-ridge; funnel-shaped mouth; handle from neck to shoulder. Encircling lines round neck and rim; bands of encircling lines round body; swastika composed of groups of small, concentric circles in front; two groups of small, concentric circles on sides; ladder-pattern on handle. Height 13.1. — 15.
11. Black Slip II oval jug with base-ring; neck widening upwards; pinched rim; handle from rim to shoulder. Fluted body; grooved lines round shoulder. Height 22.0. — 10.
12. White Painted III jug with base-ring; depressed ovoid body; cylindrical neck; pinched rim; handle from rim to shoulder. Encircling lines round neck and shoulder; eye-ornament below rim; ladder-pattern on handle. Height 17.0. — 12.
13. White Painted II bowl with base-ring, depressed sides; semicircular spout; horizontal, knobbed handle at rim. Encircling lines outside and inside; ladder-pattern on spout. Length 28.5. — 10.
14. White Painted III bowl with base-ring, angular outline; nearly straight sides; two horizontal handles. Encircling lines round body. Diam. 11.2. — 10.
15. Plain White II jug with base-ring; ovoid body; neck tapering upwards; annular rim; handle from neck to shoulder. Height 26.0. — 10.
16. Black-on-Red I (III) ovoid jug with base-ring, cylindrical neck; pinched rim; handle from rim to shoulder. Fluted body; grooved lines round shoulder; encircling black lines round body and neck; framed zigzag line on handle. Height 22.5. — 10.
17. Plain White III horn-shaped vase with flat base, flaring rim; a vertical handle at the middle of body. Height 25.5. — 10.
18. Black Slip II depressed ovoid amphoriskos on low foot; wide, cylindrical neck; flat rim, handles from rim to shoulder. Fluted body; grooved lines round shoulder. Height 16.6. — 10.
19. Black Slip II amphoriskos, similar to No. 18, but with depressed globular body and slightly concave neck. Height 11.6. — 10.
20. Black Slip II jug, as No. 11. Height 22.0. — 10.
21. Biconical spindle-whirl of black steatite, with a hole pierced lengthwise. Length 2.1. — 8.
22. White Painted III ovoid amphora with base-ring; wide, slightly concave neck; swollen, sloping rim; horizontal handles on shoulder. Encircling bands and lines round neck, body, and base; on shoulder four lattice triangles with a filled top lozenge. Height 43.6. — 10.
23. Bronze fibula with thick, angular, beaded bow; single-coiled spiral; straight pin; small, flat catch. Length 4.3. Inside No. 22.
24. White Painted III bowl with base-ring; angular outline, straight sides; two horizontal handles. Encircling lines round body. Diam. 11.5. Inside No. 22.
25. Black Slip II oval jug, as No. 11. Height 21.0. — 10.
26. White Painted III bowl, as No. 14. Diam. 12.7. — 10.

27. Plain White III oval jug with wide, cylindrical neck; plain rim; handle from rim to shoulder. Height 8.7. — 10.
28. Black Slip I jug, with base-ring; depressed ovoid body; concave neck, widening upwards; pinched mouth; handle from rim to shoulder. Fluted body and three horizontal, grooved lines round shoulder. Height 20.0. — 10.
29. White Painted II jug with low foot; globular body. Neck and handle missing. Decoration obliterated. Height 10.5. — 9.
30. Black Slip II jug, as No. 11. Height 22.3. — 12.
31. White Painted II plate with raised base and two horizontal handles. A double band of lattice lozenges on base. Decoration much faded. Diam. 22.0. — 8.
- 32 and 89. A pair of boat-shaped, oblong earrings of gold with overlapping ends, and a cluster of five gold balls added below. Diam. 3.0. — 10.
33. Two gold mountings, as No. 4. Diam. 2.4. — 10.
34. Plain, circular finger-ring of gold. Diam. 2.2. — 10.
35. Circular earring of gold with overlapping ends, slightly swollen below. Diam. 2.7. — 10.
- 36 and 38. A pair of gold earrings, as No. 32 and 89, but with smaller gold balls. Diam. 2.35. Floor.
37. Two gold mountings, as No. 4. Diam. 2.4. — 10.
38. See No. 36. Floor.
39. Circular spindle-whirl of grey steatite, with one flat side; the other side convex, with a hole pierced lengthwise. Diam. 1.9. Floor.
40. Rectangular gold plaque; short sides with rolled-up edges; pierced holes in top corners. Embossed representation of a naked, female figure with hands in pose of adoration; type similar to that of No. 1. Length 4.7. — 12.
41. Gold plaque as No. 1. Well preserved. Left bottom corner restored. Length 4.3. — 15.
42. White Painted III goat-shaped vase with cylindrical body; short, straight legs; cylindrical neck; triangular head; small ears, and a twin-handle from head to middle of back, suggesting horns. Encircling line round neck; vertical strokes on legs; groups of vertical parallel lines on body. Length 16.9. — 15.
43. Bichrome III barrel-shaped jug with narrow neck; handle-ridge; funnel-shaped mouth; handle from neck to shoulder. Encircling lines round neck; encircling bands and groups of concentric circles on body; mouth covered with paint; ladder-pattern on handle. Height 7.7. — 11.
44. White Painted II spherical jug with flat, raised base; narrow, funnel-shaped mouth; handle from neck to shoulder. Encircling lines round rim, neck, and body; maltese cross on base; ladder-pattern on handle. Height 5.9. Floor.
45. Red Slip I (III) squat amphoriskos with short stem; wide, concave neck; annular rim; handles from rim to shoulder. Height 8.1. Floor.
46. Gold mounting, as No. 4. Diam. 2.6. — 15.
47. Flat, circular finger-ring of bronze with overlapping ends. Diam. 1.7. — 36.
48. a) Conical seal of blue faience, with a hole pierced at the top; an incised, encircling line round base. Carved representation of standing figure to the right, and an animal in perpendicular position in front of him. Height 1.1.
b) Biconical stone bead with a hole pierced lengthwise. Length 1.4. Floor.
49. Straight pin of bronze with a large, cylindrical head of rock-crystal; the head with rounded base, flat top, and a deep grooved line round top. Length 5.7. Floor.
50. Gold mounting, as No. 4. Diam. 2.4. Floor.
51. Fragment of a bow of a bronze fibula; beaded, with angular fore-end. Length 4.0. Floor.
52. Black Slip II jug, as No. 11. Height 22.0. Floor.
53. White Painted III goat-shaped vase, as No. 42. Length 16.9. — 10.
54. Grey Polished squat jug with low foot; slightly concave neck; pinched mouth; handle from rim to shoulder. Height 6.9. — 10.
55. Black Slip Painted II amphoriskos with low foot; biconical body; wide, concave neck; flat rim; handles from rim to shoulder. Body fluted and covered with black paint; grooved lines round shoulder; encircling black line round neck; transverse lines on rim; ladder-pattern on handles. Height 9.1. Floor.
56. White Painted II amphoriskos with low foot, squat body; slightly concave neck; flat rim; handles from rim to shoulder. Encircling lines round foot, shoulder, and neck; transverse lines on rim; ladder-pattern on handle. Height 9.7. — 10.
57. Circular golden pendant with a central cone, encircled with framed, twisted string; a similar string around edge; a fluted tube attached as a tangent to the disc, by which pendant was threaded on a necklace. Diam. 3.75. — 34.
58. Black-on-Red I (III) bowl with short, stemmed foot; angular outline; nearly straight sides; an encircling ridge below rim; two horizontal handles. Encircling lines outside and inside; one side decorated with a lattice triangle, the other side with two framed lattice lozenges, flanked by four swastikas. Diam. 15.6. — 25.
59. White Painted II amphoriskos, as No. 56. Height 11.8. — 24.
60. Black-on-Red I (III) barrel-shaped jug with narrow neck; handle-ridge; funnel-shaped mouth; handle from neck to shoulder. Encircling lines round body; winged lattice lozenges in front and below handle; encircling lines round neck; ladder-pattern on handle. Height 8.5. Floor.
61. Black Slip II amphoriskos, as No. 18. Rim and handles missing. Height 16.0. — 20.
62. Black Slip II amphoriskos, as No. 18. Height 16.0. — 25.
63. White Painted III goat-shaped vase, as No. 42, but with lattice squares. Length 17.1. In No. 69.

64. Bichrome Red I (III) squat jug with rounded base; narrow, short neck; flaring mouth; handle from neck to shoulder. A spiral encircled by a red band and four black lines on base; encircling lines round shoulder; wavy line round neck; a spiral inside the rim; ladder-pattern on handle. Height 6.8. — 20.
65. Grey Polished amphoriskos with low foot; squat body; slightly concave, wide neck; flat rim; handles from rim to shoulder. Height 7.9. — 25.
66. White Painted I ovoid jug with low foot; narrow, short neck; handle from rim to shoulder. Around body a metope decoration of vertical, latticed bands, framed by parallel lines and encircled by concentric lines; foot covered with black paint. Neck and handle missing. Height 18.0. In No. 67.
67. Red Slip I (III) bowl with short, stemmed foot; angular outline, nearly straight sides; two horizontal handles. Three encircling grooved lines below rim. Diam. 16.5. — 25.
68. Black Slip II amphoriskos, as No. 18. Height 15.6. — 34.
69. Red Slip I (III) deep, open bowl with base-ring; two horizontal handles below rim. Six encircling grooved lines below rim. Diam. 19.2. — 26.
70. White Painted II oval jug with base-ring. Upper part missing. Decorated with encircling lines. Height 12.5. — 21.
71. White Painted I ovoid amphoriskos with low foot; short neck tapering upwards; flat rim; handles from rim to shoulder. Encircling bands round foot and base of neck; ladder-pattern on rim and handles. Height 12.9. — 34.
72. White Painted I plate with base-ring, and two horizontal handles below rim. Four lattice triangles meeting in a dot on base; encircling lines and bands around base; encircling lines and bands inside. Diam. 14.5. — 32.
73. White Painted I miniature amphoriskos belonging to a ring-shaped vase. The base was attached to the ring. The body is almost globular with concave neck; splaying rim; two horizontal handles on shoulder. Encircling bands on body and neck; transverse lines on rim. Height 5.4. — 32.
74. White Painted II oval amphora with pointed base; neck slightly tapering upwards; plain rim; two vertical handles on body. Encircling lines round shoulder and body; on neck broad bands and encircling lines. Part of neck missing. Height 16.7. — 22.
75. Grey Polished depressed amphoriskos with low foot; cylindrical, wide neck; stilted rim and two vertical handles from rim to shoulder. Height 5.7. — 20.
76. White Painted II miniature jug with depressed globular body, low foot; long, concave neck; splaying rim; handle from neck to shoulder. Encircling lines round body and neck; three framed lattice triangles on shoulder; wavy lines round neck; ladder-pattern on handle. Foot missing. Height 7.6. — 14.
77. White Painted II oval jug with base-ring. Upper part of body missing. Decoration obliterated. Height 15.4. — 26.
78. Grey Polished amphoriskos, as No. 65. Height 6.0. Floor.
79. Grey Polished amphoriskos, as No. 65. Height 6.0. Floor.
80. Bichrome III pilgrim-bottle with narrow neck; handle-ridge; flaring rim; two handles from neck to shoulder. Encircling black and red lines round neck; concentric circles on body; ladder-pattern on handles. Height 9.0. — 9.
81. Black Slip II jug, as No. 11. Upper part missing. Height 11.9. — 15.
82. Bichrome II oval jug with base-ring; short neck; pinched mouth; handle from rim to shoulder. Black and red encircling bands. Height 13.1. — 10.
83. White Painted II miniature jug with squat body; low foot; semicircular spout on shoulder; handle from rim to shoulder. Encircling lines round neck and shoulder. Height 7.0. — 25.
84. Bichrome III lentoid bottle with narrow neck; flaring rim; two handles from neck to shoulder. Concentric circles on body; encircling lines round mouth; ladder-pattern on handles. Height 13.5. — 10.
85. Plain White II globular jug with low foot; neck tapering slightly upwards; plain rim; handle from neck to shoulder. Height 14.6. — 25.
86. Black Slip II jug, as No. 11. Height 11.2. — 25.
87. White Painted I plate with flat base, and two horizontal handles below rim. Four framed lattice triangles meeting in a group of concentric circles, encircled by concentric lines and bands; encircling lines inside. Diam. 23.0. — 25.
88. Bichrome II ovoid jug, as No. 82. Height 14.5. In No. 120.
89. See No. 32. — 10.
90. Fragment of a finger-ring of bronze with flat section. — 12.
91. Gold mounting, as No. 4. Diam. 2.4. — 30.
92. Gold plaque, as No. 40. Length 4.7. — 10.
93. Gold mounting, as No. 4. Diam. 2.4. — 10.
94. Gold plaque, as No. 2. Length 2.5. — 10.
95. Gold mounting, as No. 4. Diam. 2.4. — 10.
96. Bronze fragments of several finger-rings with flat sections. — 32.
97. Biconical spindle-whirl of stone with a hole pierced lengthwise. Length 2.3. — 31.
98. Bichrome III barrel-shaped jug with narrow neck; flaring rim; handle from neck to shoulder. Encircling black and red lines round neck; concentric circles on body. Handle missing. Height 8.0. Floor.
99. Shallow, conical bronze bowl with round base; annular rim, central boss inside the bottom. Diam. 14.9. Floor.
100. Black Slip II jug, as No. 25. Height 22.8. Floor.
101. Black-on-Red I (III) barrel-shaped jug with narrow

- neck; handle from neck to shoulder. Groups of concentric circles on body. Mouth missing. Height 8.5. In No. 102
102. Black-on-Red I (III) deep bowl with base-ring, angular outline; two horizontal handles below rim. Encircling grooved lines round rim; encircling black line inside rim. Diam. 24.2. Floor.
103. White Painted III amphora with base-ring; wide, slightly concave neck, splaying rim; two vertical, small handles on shoulder. Encircling lines round shoulder, body, and base; three vertical, parallel lines on shoulder, broad bands and encircling lines round neck. Height 26.0. Floor.
104. Black Slip II jug, as No. 11. Height 21.0. Floor.
105. Coarse oval jug with flat base; short, wide neck; pinched mouth; handle from rim to shoulder. Height 9.5. Floor.
106. White Painted I amphoriskos, probably belonging to the same ring-shaped vase as No. 73; slightly pear-shaped body, handles from rim to shoulder. Encircling lines on body and neck; transverse lines on rim and handle. Height 5.4. Floor.
107. White Painted I shallow bowl with base-ring; flat rim; two horizontal handles below rim. Concentric circles on base; framed lattice triangles on body; spiral inside the bottom. Diam. 6.2. Floor.
108. White Painted I vase with low foot; body in shape of a pomegranate; probably belonging to the same ring-shaped vase as No. 73. Encircling lines round body. Height 6.3. Floor.
109. Grey Polished globular jug with low foot; narrow, concave neck; pinched mouth; handle from rim to shoulder. Height 8.1. — 27.
110. White Painted II bird-shaped vase with three short legs; narrow bird's neck; head with tubular hole and projecting eyes; straight, flat tail; two horizontal wings attached to body. At the bird's back is the narrow, concave neck of vase with splaying rim; two handles from neck to bird's back. A vertical band of hatched triangles on both sides of bird's neck; black painted eyes; a horizontal band of filled triangles on both sides of body above wings; contiguous bands of ladder-pattern in front; transverse lines on tail and wings; ladder-pattern on handles; lower part of legs covered with black paint. Length 18.5. — 28.
111. Bichrome III pilgrim-bottle with narrow neck, widening upwards; two handles from neck to shoulder. Decoration as No. 80. Height 8.8. — 26.
112. White Painted II jug, as No. 44. Height 6.0. — 28.
113. Bichrome II pilgrim-bottle, as No. 80. Height 13.5. — 28.
114. Grey Polished jug, as No. 109. Height 7.8. — 20.
115. Plain White II box with angular shoulder; raised rim; two horizontal handles on body. Height 7.4. In No. 120.
116. Bichrome III barrel-shaped jug with narrow neck, widening upwards; splaying rim; handle from neck to shoulder. Concentric black and red circles on body; concentric lines round mouth; framed zigzag line on handle. Height 12.5. In No. 120.
117. Grey Polished jug, as No. 109. Height 8.1. — 26.
118. Black-on-Red I (III) squat jug with flat base, narrow neck with handle-ridge; funnel-shaped mouth; handle from neck to shoulder. Encircling lines on body and neck; concentric lines round mouth, four swastikas on shoulder; ladder-pattern on handle. Height 7.0. — 24.
119. White Painted II jug, as No. 44. Height 6.0. — 20.
120. White Painted I plate with flat, raised base; and two horizontal handles below rim. Four lattice triangles meeting in a small central circle on base; encircling bands around base and inside bottom. Diam. 24.6. — 22.
121. White Painted II oval amphora, similar to No. 74; but with concave neck. Neck covered with broad bands and encircling lines between; encircling lines round shoulder and body. Height 33.0. Floor.
- 122 a) Plain, straight pin of ivory. Not complete.
b) Two small gold beads. Length 4.8. Floor.
123. Fragments of several plain finger-rings of bronze. Floor.
124. White Painted II cylindrical flask with two upright standing, horizontal handles on shoulder. Encircling lines and bands round upper part of body; vertical bands of contiguous lattice lozenges framed by parallel lines. Neck missing. Height 16.0. Floor.
125. Black Slip I amphoriskos with low foot; concave neck; flat rim; two handles from rim to shoulder. Fluted body; horizontal, grooved lines round shoulder. Height 13.8. — 25.
126. Plain, circular disc of ivory with a hole pierced in the centre. Broken. Diam. 6.1. — 18.
127. Incense-burner of terracotta, ladle-shaped, with tall, flat handle pierced with a hole at the upper, rounded end. The handle is decorated with horizontal bands of zigzag lines, lattice lozenges, and lattice bands; two concentric circles at base of handle. Height 29.8. Floor.
128. Bichrome II jug, as No. 82. Height 14.7. Floor.
129. White Painted II miniature jug, as No. 83. Height 7.3. Floor.
130. Black Slip II jug, as No. 11, but with depressed ovoid body. Neck and handle missing. Height 13.0. Floor.
131. Black Slip II jug, as No. 11. Height 9.5. Floor.
132. Bichrome II oval jug with base-ring; very short neck; pinched mouth; handle from rim to shoulder. Encircling lines and bands; lattice triangles on shoulder; an eye-ornament below rim. Height 8.5. Floor.
133. Bichrome III jug, as No. 98. Height 8.0. Floor.
134. Black-on-Red I (III) jug, as No. 60. Height 8.2. Floor.
135. Bichrome I barrel-shaped jug with narrow, concave neck; collar-shaped mouth; handle from neck to shoulder. Encircling black and red lines round mouth; concentric black and red circles on body; and ladder-pattern on handle. Height 13.7. Floor.

Bronze				Gold					Terra-cotta	Faience	Stone		Ivory		
Pin	Fibula	Finger-ring	Bowl	Earring	Finger-ring	Bead	Pendant	Mounting	Plaque	Incense-burner	Seal	Spindle-whirl	Bead	Pin	Button
49	51	47 96 123	99	36 38		b) 122	57	50 91		127	a) 48	39 97 140	b) 48	a) 122	
-1	-1	-3	-1	-2		-1	-1	-2		-1	-1	-3	-1	-1	
															126 -1
	23	90		32 35 89	34			4 33 37 93	33 46 41 92	1 2 3 94		21		5	
	-1	-1		-3	-1			-6		-7		-1		-1	

CHRONOLOGY

As shown by the diagram the first burial period is represented by pottery of Types I—III: White Painted I—III, Bichrome I—III, Black-on-Red I (III), Black Slip II, Red Slip I (III), and Grey Polished Ware. The specimens of Type II are in majority, and those of Type I are generally late in style. This combination of pottery types assigns the first burial period to the beginning of Cypro-Geometric III.

The second burial period is also represented by pottery of Types I—III: White Painted I—III, Bichrome II—III, Black-on-Red I (III), Black Slip I—II, Red Slip I (III), Grey Polished, and Plain White II. The specimens of Type II are majority and those of Type I are few. Thus, the second burial period can be assigned to a somewhat later stage of the first part of Cypro-Geometric III.

The third burial period is represented by pottery of Types II—III: White Painted II—III, Bichrome II—III, Black-on-Red I (III), Black Slip II, Red Slip I (III), Grey Polished, and Plain White II—III. Besides, a single specimen of Black Slip I Ware was found. This combination of pottery types assigns the third burial period to about the middle of Cypro-Geometric III.

TOMBS 404—405 (Figs. 71; 72: 1—4)

		SIZE			
		Length	Width	Depth	Height
Tomb 404.	Dromos	1.75	1.32	1.40	—
	Chamber	1.66	0.86	—	0.63
	Niche	c. 1.30	0.50	—	0.42
Tomb 405	1.95	1.00	0.75	—

SHAPE

Tomb 404 is of a different type from most of the others on this site. The dromos is a roughly quadrangular, vertical shaft with rounded corners. In the north wall a niche was cut in the rock, 0.50 m. above the floor of the dromos. The west, and a part of the north rock wall of this niche had been broken through by the cutting of the dromos of Tomb 405 and the tomb-cutter, seeing that if he cut further he would arrive at the tomb itself, stopped work and used the shaft already cut as a tomb, covering it with stone slabs.

The chamber of Tomb 404 is smaller than the dromos shaft and is more of a niche than a tomb-chamber, the whole of its front side opening on to the dromos: this front was closed by a packing of rough stones. The floor and the roof of the chamber are approximately horizontal, and the floor of the dromos descends to that of the chamber by an oblique step.

STRATIFICATION

The dromos of Tomb 404 was filled with homogeneous layers of *chavara*. In the chamber there was a burial and culture stratum at the bottom covered by a thin top layer of rock dust from the weathered rock. In Tomb 405 there was a burial layer at the bottom and an upper filling of *chavara* and crumbled rock. All the objects were found on the floor, except Nos. 4 and 5, which were placed on the top of No. 6 in the second burial (cf. below).

BURIALS

In Tomb 404 two burials had taken place. The skeleton of the first body was found packed into amphora No. 6 in order to make room for the second body. Skeletal remains of this were found along the front side of the chamber with the head near the right wall. Tomb-gifts, in pots, were placed all around the skeleton.

In Tomb 405 one body had been buried, the skeletal remains of which were found in the longitudinal axis of the chamber with the head near the left wall. Of the bones the skull, the spinal column and parts of the upper and lower extremities were preserved in such a manner, that it could be concluded that the body had been placed on its left side with slightly bent and crossed legs. Tomb-gifts, in one pot, had been offered to the deceased.

FINDS (GROUP: PL. XLIV, 2; TYPES: L. OF PL. II)

- | | |
|--|---|
| <p style="text-align: center;">T o m b 404</p> <ol style="list-style-type: none"> 1. Coarse shallow, open bowl with round base and two handles from rim to body. Diam. 16.6. Floor. 2. White Painted II oval amphora with base-ring and two horizontal handles. Encircling bands round shoulder, belly, and base; metope decoration of lattice triangles and parallel vertical lines on shoulder; encircling lines and bands on neck. Upper part of neck missing. Height 31.5. Floor. 3. Plain White III ovoid, rather biconical jug with flat base; narrow, cylindrical neck; annular rim; handle from neck to shoulder. Height 14.5. Floor. | <ol style="list-style-type: none"> 4. Black Slip II oval jug with base-ring; slightly concave neck, splaying upwards; pinched mouth; handle from rim to shoulder. Fluted body and three to four grooved lines on shoulder. Height 14.8. On No. 6. 5. Coarse oval jug with raised, flat base; wide, cylindrical neck; handle from rim to shoulder. Height 17.5. On No. 6. 6. White Painted III depressed biconical crater with base-ring; swollen rim; two vertical handles on shoulder. Encircling lines and bands round rim, belly, and base, on shoulder framed lattice triangles with filled lozenges on top. Height 22.0. Floor. |
|--|---|

- 7. Coarse oval amphora with raised, flat base; wide, cylindrical neck; handles from rim to shoulder. Height 25.3. Floor.
- 8. Black Slip II oval jug, shape as No. 4. Three horizontal, grooved lines around shoulder. Height 36.2. Floor.
- 9. White Painted II deep plate with flat, raised base and two knobbed, horizontal handles. Encircling lines and bands around base; concentric circles inside; a broad band of lattice lozenges framed by parallel lines and flanked by lattice triangles on base. Diam. 28.6. Floor.
- 10. Bichrome II plate with flat, raised base, and two horizontal handles. Bichrome concentric circles and encircling lines. Diam. 31.4. Floor.
- 11. Black Slip II oval jug, shape as No. 4. Four horizontal, grooved lines round shoulder. Height 25.5. Floor.
- 12. Plain White II bowl with short, stemmed foot; angular outline; nearly vertical sides; three handles from rim to body. Diam. 15.7. Floor.
- 13. Coarse oval jug, as No. 5. Height 18.7. Floor.
- 14. Black Slip II oval jug, shape as No. 4. Five horizontal, grooved lines round the shoulder. Height 24.2. Floor.
- 15. Bichrome III deep bowl with base-ring; angular outline; straight, vertical sides; upright, horizontal handles. Bichrome encircling lines around rim, body, and base; four horizontal, grooved lines round rim. Diam. 20.4. Floor.
- 16. White Painted II open bowl with short, stemmed foot; rather curved outline; two horizontal handles. Encircling band. Diam. 17.6. Floor.
- 17. Biconical spindle-whirl of steatite. Length 3.0. Floor.

T o m b 4 0 5

- 1. Plain White III jug with base-ring; globular body; neck with handle-ridge; handle from neck to shoulder. Upper part of neck missing. Height 17.5. Floor.

Summing up the classification given in the Object Register, we obtain the following diagram:

	P o t t e r y									Stone
	Wh. P. II	Wh. P. III	Bichr. II	Bichr. III	Bl. Sl. II	Pl. Wh. II	Pl. Wh. III	Coarse W.	Spindle-whirl	
Tomb 404	2. 9. 16 -3	6 -1	10 -1	15 -1	4. 8. 11. 14 -4	12 -1	3 -1	1. 5. 7. 13 -4	17 -1	
Tomb 405							1 -1			

C H R O N O L O G Y

The pottery of Tomb 404 consists of a majority of Type II and a few specimens of Type III: White Painted II—III, Bichrome II—III, Black Slip II, and Plain White II—III; the tomb dates, therefore, from the early part of Cypro-Geometric III. Tomb 405 must be later than Tomb 404 (cf. p. 193) but the single pot of Plain White III ware found in the tomb assigns it to the same period, i. e. Cypro-Geometric III.

T O M B 4 0 6 (Figs. 72: 5—9; 73)

	S I Z E			
	Length	Width	Depth	Height
Dromos	4.75	0.74	1.95	—
Stomion	0.17	0.70	—	1.20
Chamber	2.70	2.18	—	1.04

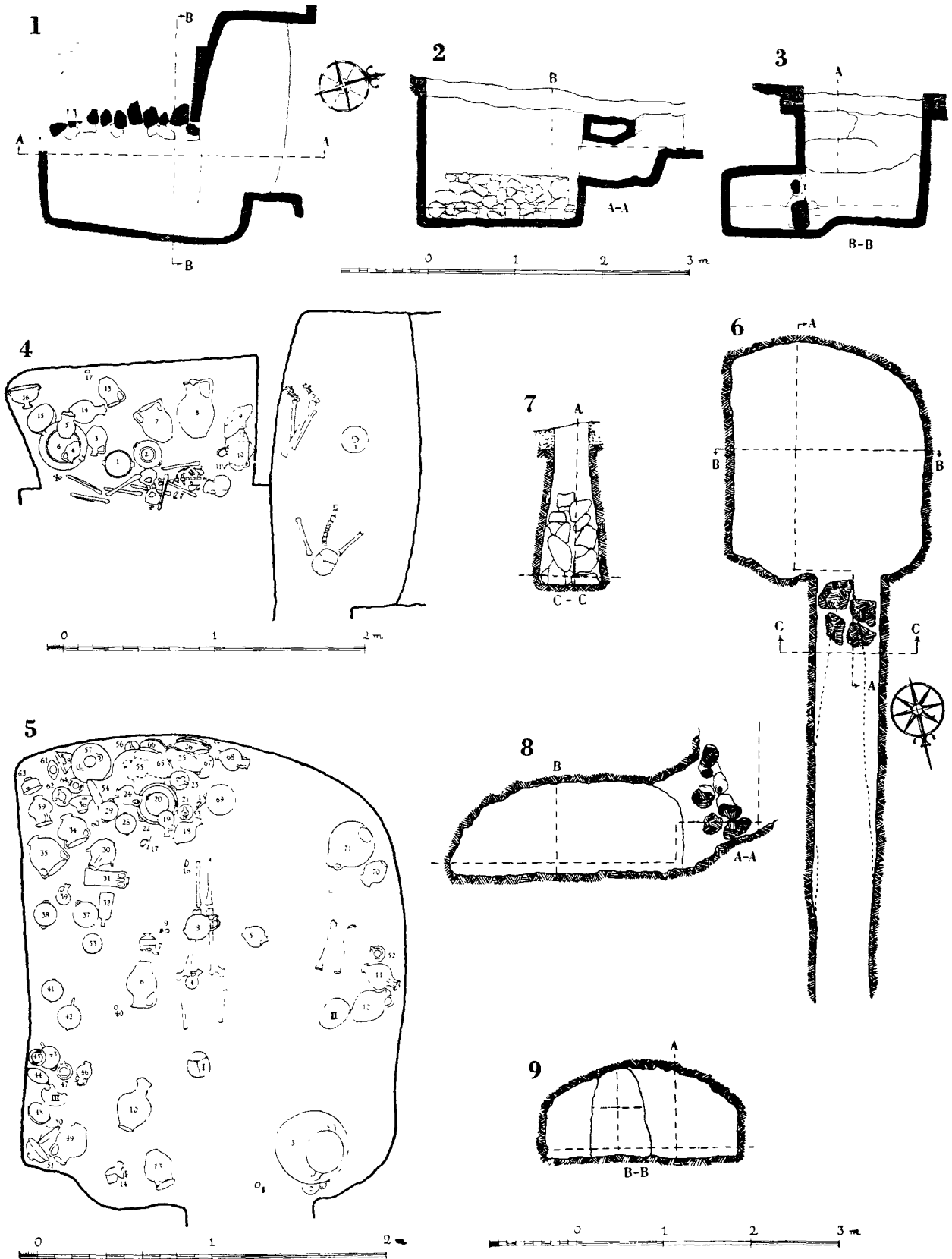

Fig. 72. Lapithos. Tombs 404—405, Plan (1); Sections A-A and B-B (2—3); Finds *in situ* (4). Tomb 406, Finds *in situ* (5); Plan (6); Sections C-C, A-A, B-B (7—9).



Fig. 73. Lapithos. Tomb 406, dromos.



Fig. 74. Lapithos. Tomb 409, dromos.

SHAPE

The dromos is a long and narrow passage. In plan, it widens towards the door, but narrows upwards with slightly curved side walls, so that they nearly converge above the door, and that the dromos in the upper plane has the shape of a wedge. The floor of the dromos slopes, by wide and worn steps, down to the door. The doorway fills the whole width of the dromos: it has a curved roof and was closed by a packing of rough stones. It opens on to the chamber, to the right of its longitudinal axis and the floor of the dromos descends to that of the chamber by a gentle slope. The chamber is irregular in plan with a straight left wall, curved back, and right side walls, and a concave front wall. The floor slopes towards the back wall and the roof is vaulted.

STRATIFICATION

The dromos was filled with layers of homogeneous *chavara*, at the bottom mixed with potsherds. In the chamber, there was a burial and culture stratum on the floor. Above this there was a filling, up to the roof, consisting of layers of infiltrated earth and *chavara* from the dromos brought in by the winter rains, mixed with some rock from the weathered roof and walls of the chamber. There was only one burial stratum and all the objects were originally placed on the floor or in the culture layer, but some had floated about in

the infiltrated water and were found moved from their original position at different levels in the silted filling.

BURIALS

Remains of three bodies were found in the chamber. Of the skeletons only one (Skeleton I) was preserved *in situ*, with the skull, the upper and lower extremities and the pelvis in such a position that it is evident that the body had been placed along the longitudinal axis of the chamber, in an outstretched, dorsal position with the head towards the door. Of Skeleton No. II, the skull and the femora were found along the right wall, and of Skeleton No. III only the skull was found near the left wall of the chamber in the left front corner. The other bones of these skeletons were found scattered about, in the silted filling layer. Body No. I had been adorned with a gold nose-ring (No. 1, cf. p. 265) and was provided with spindle-whirls of stone (No. 9), indicating that it was female. Body No. III had a finger-ring of bronze (No. 14). The dresses of the deceased were fastened by pins and fibulae of bronze (Nos. 15 a, b, 16, 17 a, b, 102, 103). Tomb-gifts had been offered in many vases of terracotta, and also a bronze bowl (No. 33).

FINDS (GROUPS: PLS. XLV, I, XLVI, I; TYPES: L. OF PL. II)

1. Circular gold nose-ring (?), slightly swollen below. Diam. 2.6. Floor.
2. Bichrome I spherical jug with narrow, slightly concave neck; collar-shaped mouth; handle from neck to shoulder. Concentric lines and bands on body, and a chain of lattice lozenges as front decoration. Height 16.0. — 33.
3. White Painted I large amphora with base-ring; two handles from neck to shoulder; concave neck; splaying, swollen rim. Encircling lines and bands around body, neck, and rim; a wavy line on the handles, framed by two horizontal lines; groups of seven or eight short lines pendant from base of neck. Height 57.0. Floor.
4. White Painted I spherical jug with round base; narrow neck; collar-shaped mouth; a handle from neck to shoulder. Four circle-spirals on body; encircling lines round mouth. Height 12.4. — 2.
5. White Painted I jug with base-ring; pinched mouth; handle from rim to shoulder. The body is covered with black paint; encircling lines and lattice triangles on shoulder. Neck missing. Height 16.3. — 8.
6. White Painted I ovoid jug, as No. 10. Encircling lines and bands round body; latticed, framed band on shoulder; wavy lines around neck; framed, wavy line along handle. Height 26.0. Floor.
7. White Painted I askos with flat, cylindrical body; low foot; an animal's head; basket-handle; cylindrical spout on the convex top. Encircling lines; band of lattice lozenges around body and on top. Height 13.7. Floor.
8. Black Slip I globular jug with base-ring; slightly tapering, concave neck; handle from neck to shoulder. Ridge around neck. Fluted body. Pieces of neck and rim missing. Height 17.5. — 2.
- 9 a) Conical spindle-whirl of terracotta with flat base and top, and a hole pierced in the middle. Diam. 2.7.
- b) Biconical small spindle-whirl of steatite, with a hole pierced in the middle, and decorated with incised lines and encircled dots. Length 2.0. Floor.
10. White Painted I jug with base-ring; pinched mouth; handle from rim to shoulder. Encircling lines and bands on body; wavy lines around neck and along handle; groups of pendant lines on shoulder. Height 30.5. — 26.
11. White Painted I jug, as No. 10. Encircling lines and bands on body; wavy lines on handle and around neck. Height 22.7. — 2.
12. Bichrome I slim, oval jug with base-ring; short, concave neck; pinched mouth; handle from rim to shoulder. Encircling lines and bands; framed lattice triangles on shoulder; ladder-pattern on handle. Height 25.5. — 7.
13. Coarse oval jug with flat base; short, wide, cylindrical neck; slightly splaying rim; handle from rim to shoulder. Height 19.0. — 7.
14. Fragment of a Plain White I spherical jug. Height c. 18.0. Floor.
- 15 a) Bronze fibula with arc-shaped, beaded bow; single-coiled spring and straight pin. Pieces of pin missing. Length 4.5.
- b) Straight, thin bronze pin with pointed end, and a head in shape of a pomegranate. Length 7.0. Floor.
16. Bronze fibula with angular, beaded bow; flat catch; straight pin; single-coiled spring. Length 4.3. Floor.
- 17 a) Bronze fibula, as No. 15 a. Pin missing. Length 5.0.
- b) Bronze pin, as No. 15 b. Length 7.6. Floor.

18. Black Slip I oval jug with base-ring; depressed shoulder; concave neck; pinched mouth; handle from rim to shoulder. Fluted body. Height 18.0. Floor.
19. White Painted I barrel shaped jug with narrow, concave neck; concave, collar-shaped mouth with splaying rim; handle from neck to shoulder. A spiral around mouth; four encircled, maltese crosses on body; ladder-pattern on handle. Height 15.3. Floor.
20. Bichrome I funnel-shaped bowl with splaying sides and two horizontal handles. Lattice triangles below rim and encircling lines around body. Diam. 13.4. In No. 21.
21. White Painted I plate with flat base and two horizontal handles. Four lattice triangles meeting in a latticed square on base, encircling lines and bands around base and inside. Diam. 20.6. In No. 22.
22. White Painted I plate, as No. 21. Bands of lattice lozenges flanked by two lattice triangles on base; concentric lines and bands inside. Diam. 23.0. Floor.
23. White Painted I jug with low foot; oval body; concave neck; pinched mouth; handle from rim to shoulder. Lower part of body covered with black paint; encircling lines and lattice triangles on shoulder. Height 15.4. Floor.
24. White Painted I depressed globular jug with low foot; concave neck; splaying rim; handle from rim to shoulder; on shoulder semicircular spout covered with a strainer. Encircling lines and bands around rim, body, and foot; vertical bands of filled lozenges framed by parallel lines on shoulder; ladder-pattern on handle. Height 15.3. On Nos. 21, 22, 54.
25. White Painted I plate, shape as No. 21, and decoration as No. 22. Diam. 22.7. Floor.
26. White Painted I plate, shape as No. 21, and decoration as No. 22. Diam. 20.0. Floor.
27. White Painted I plate, shape as No. 21. Four latticed, framed triangles meeting in a central ornament of hatched, framed hour-glass pattern on base; encircling lines and bands around base; groups of concentric circles inside. Diam. 20.5. Floor.
28. White Painted I bowl with low stem; softly rounded outline, two horizontal handles below the rim. Encircling bands below handles and around foot; a lozenge-ornament consisting of lattice lozenges forming a secondary cross and flanked by latticed, framed, vertical bands between handles. Diam. 12.0. Floor.
29. White Painted I flat bowl with base-ring and two horizontal handles below rim. Concentric lines on body and encircled wheel on base; concentric circles inside. Diam. 11.5. Floor.
30. White Painted I ovoid hydria with base-ring; slightly concave neck; one handle from rim to shoulder and two horizontal handles on shoulder. Encircling lines and bands around base, body, shoulder, and neck; ladder-pattern on handles. Upper part of neck repaired. Height 18.5. Floor.
31. White Painted I cylindrical flask with flat base; short, narrow, concave neck; flaring rim; three triple-handles from neck to shoulder. Groups of pendant lines on shoulder, body of flask divided by encircling lines in horizontal zones; upper zone decorated in front with a comb-ornament, flanked by vertical, framed zigzag lines; middle zone with horizontal, double zigzag lines; lower zone with vertical bands of framed, dotted lozenges; base zone in front with four filled triangles; groups of transverse lines on handles. Height 24.8. Floor.
32. White Painted I cylindrical flask with two horizontal string-hole handles. Encircling lines and bands around body; string-holes flanked by groups of vertical lines. Height 19.4. Floor.
33. Fragments of a hemispherical bronze bowl with round base. Diam. c. 11.5. Floor.
34. White Painted I depressed pear-shaped amphora with low foot; wide, short, slightly tapering neck; handles from rim to shoulder. Lower part of body covered with black paint; encircling lines on shoulder; band around base of neck; a wavy line along handle. Height 15.2. Floor.
35. Coarse oval amphora with flat, raised base; short, concave neck; flaring rim; handles from rim to shoulder. Height 21.0. Floor.
36. White Painted I deep, funnel-shaped bowl with flat base; splaying sides, two horizontal handles. Encircling lines and bands round rim and base; a maltese cross on base. Diam. 13.0. Floor.
37. White Painted I plate with one horizontal handle and a shaft opposite the handle. Filled triangles arranged in two concentric circles around base; group of concentric circles inside. Diam. 14.4. Floor.
38. White Painted I shallow, open bowl with base-ring and two horizontal handles. Concentric lines on body and an encircled wheel on base. Diam. 13.3. Floor.
39. White Painted I barrel-shaped jug with narrow neck; collar-shaped mouth; handle from neck to shoulder. Four groups of concentric circles around body; encircling lines around mouth and neck; ladder-pattern on handle. Height 11.8. Floor.
40. Circular finger-ring of bronze with overlapping ends. Diam. 2.0. Floor.
41. White Painted I bowl with low foot; softly rounded outline; two horizontal handles. Encircling bands around rim, below handles, and on foot; a lozenge-ornament consisting of lattice lozenges forming a secondary cross and flanked by framed bands of filled hour-glass ornaments between the handles; an encircled wheel inside the bottom. Diam. 11.9. Floor.
42. White Painted I plate with one horizontal handle and a shaft opposite the handle. An encircled maltese cross on base. Diam. 13.4. Floor.
43. Coarse plate with base-ring, one knobbed, horizontal handle and a shaft opposite the handle. Diam. 12.6. Floor.
44. White Painted I shallow, conical bowl with low foot;

- two horizontal handles at rim. Encircling lines outside and inside. Diam. 13.5. Floor.
45. White Painted I depressed globular, small amphora with low foot; short, concave neck; horizontal handles on shoulder. Encircling lines and bands around body. Height 11.1. Floor.
46. White Painted I amphora, as No. 45, but with two vertical handles from neck to shoulder. Pendant lines on shoulder. Height 13.2. Floor.
47. Coarse small jug with flat, raised base; short, concave neck; wide mouth; handle from rim to shoulder. Height 8.6. Floor.
48. Plain White I shallow bowl with flat, raised base; two horizontal handles. Two incised lines around rim. Diam. 13.4. Floor.
49. Plain White I oval jug with base-ring; short neck, slightly tapering upwards; annular rim; handle from neck to shoulder. Ridge around base of neck. Height 22.3. Floor.
50. White Painted I funnel-shaped bowl with flat base; splaying sides; two horizontal handles. Encircling band around rim: lattice triangles meeting in an encircled cross on base; encircling lines inside. Diam. 16.0. Floor.
51. White Painted I bowl with conical body; low foot; profiled rim; two horizontal handles. Encircling lines; metope decoration of groups of vertical lines between handles; encircling lines inside; ladder-pattern on handles. Decoration nearly effaced. Diam. 16.4. Floor.
52. Coarse small jug, as No. 47. Height 10.4. Floor.
53. White Painted I jug, as No. 23, but with globular body. Height 14.7. Floor.
54. White Painted I large amphora with base-ring; concave neck; much splaying, flat rim; horizontal handles on shoulder. Encircling lines, bands, and wavy lines around body; vertical zigzag bands framed by parallel lines on shoulder; encircling broad bands around neck with concentric lines between. Height 43.0. Floor.
55. White Painted I small, depressed globular amphora with low foot; rather wide, concave neck, tapering upwards; handles from rim to shoulder. Encircling lines and bands; friezes of parallel, oblique lines around neck and shoulder. Height 13.9. In No. 54.
56. Black Slip I small, depressed oval jug with a handle from rim to shoulder. Fluted body. Neck and handle missing. Height 12.0. Floor.
57. White Painted I deep, funnel-shaped bowl with flat base; splaying sides; two horizontal handles. Encircling lines and bands round rim and base; bands of dotted, crossed, and latticed lozenges from base to rim; a framed rosette on base. Diam. 23.8. Floor.
58. White Painted I deep, funnel-shaped bowl with low foot and two horizontal handles. Encircling lines and bands round rim and base; frieze of triangles between; transverse lines on rim. Diam. 14.5. Floor.
59. White Painted I small, depressed amphora with low foot; wide, slightly concave neck; flat rim; handles from rim to shoulder. Encircling lines and bands; lattice triangles on shoulder; metope decoration of vertical, hatched bands framed by parallel lines on neck. Height 15.0. Floor.
60. Fragment of a White Painted I jug with pinched mouth. Floor.
61. Bichrome I lentoid flask (pilgrim-bottle) with narrow neck; flaring rim; handle from neck to shoulder. Concentric lines and bands on both sides of body. Height 15.8. Floor.
62. White Painted I globular, depressed stirrup-vase with short stem. Encircling lines and lattice triangles on shoulder. Height 13.3. Floor.
63. White Painted I bowl, shape as No. 28. Exterior decoration as No. 28, an encircled cross inside the bottom. Diam. 12.5. Floor.
64. White Painted I slightly depressed oval amphoriskos with low foot; concave neck with splaying rim; horizontal handles on shoulder. Encircling lines and bands around foot, body, neck, and handles. Height 12.7. Floor.
65. White Painted I plate with wide base-ring and two knobbed, horizontal handles. Four lattice bands meeting in an encircled maltese cross on base. encircling lines and bands around base-ring. Diam. 24.7. Floor.
66. White Painted I plate with flat base and two horizontal handles. Four lattice triangles meeting in a hatched, maltese cross on base; encircling lines and bands around base; a dot encircled by concentric lines and bands inside. Diam. 20.0. Floor.
67. Coarse oval jug with raised, flat base; short wide, slightly concave neck; handle from rim to shoulder. Height 13.7. Floor.
68. Black Slip I globular amphora with low foot; concave, narrow neck with flaring rim; handles from neck to shoulder. Fluted body and three horizontal grooves around shoulder. Height 18.5. Floor.
69. White Painted I bowl with short, stemmed foot; softly rounded outline; two horizontal handles. Encircling lines and metope decoration of bands of lattice lozenges framed by parallel lines between the handles. Diam. 17.0. Floor.
70. Coarse oval jug, as No. 67, but with flat base. Height 16.0. Floor.
71. Plain White I jug, as No. 49, but without ridge around base of neck. Height 26.9. Floor.
72. White Painted I plate, as No. 21. Encircling lines and bands; four lattice triangles meeting in a group of concentric circles on base; encircling lines and bands inside. Diam. 21.6. Put together of fragments from chamber and dromos.
73. White Painted I plate, as No. 21. On base a framed band of lattice lozenges flanked by two framed lattice triangles and encircled by concentric lines and bands; an encircled dot inside. Diam. 24.0. As No. 72.
74. White Painted I plate, as No. 21. On base a hatched,

- maltese cross encircled by lines and bands; spiral inside the bottom. Diam. 21.8. As No. 72.
75. White Painted I plate, as No. 21. On base four lattice triangles, encircled by lines and bands and meeting in an encircled dot; a spiral, encircling lines and bands inside. Diam. 27.8. As No. 72.
76. Bichrome I plate with flat base, and two horizontal, knobbed handles at rim. On base four latticed, framed triangles encircled by lines and bands and meeting in concentric lines and bands. Diam. 29.2. As No. 72.
77. White Painted I plate, as No. 21, but with a wheel-ornament inscribed in encircling lines and bands inside the bottom. Diam. 25.0. As No. 72.
78. White Painted I plate, as No. 21. Two lattice lozenges flanked by lattice triangles on base. Diam. 20.0. As No. 72.
79. Black Slip Bichrome I plate with raised, flat base, fluted sides, and two knobbed, horizontal handles at rim. On base lattice triangles; bands of double zigzag lines; bands of filled lozenges framed by parallel lines and meeting in bichrome, concentric circles; encircling line around rim, and bichrome, concentric circles inside the bottom. Diam. 18.0. As No. 72.
80. Black Slip Bichrome I plate, as No. 79. Lattice triangles meeting in concentric bichrome circles on base; encircling lines inside. Much restored. Diam. 20.9. As No. 72.
81. White Painted I barrel-shaped jug with narrow, concave neck; collar-shaped, concave mouth; handle from neck to shoulder. Concentric circles on body; ladder-pattern on handle; vertical lines on mouth. Height 28.3. As No. 72.
82. Bichrome I barrel-shaped jug with short, concave, narrow neck; ridge around base of neck; twin-handle from neck to shoulder. A maltese cross encircled by concentric lines and bands on both sides of body. Mouth missing; decoration faded. Height 18.9. As No. 72.
83. White Painted I barrel-shaped jug with narrow neck; splaying rim; handle from neck to shoulder. Five groups of spirals on body. Height 9.3. As No. 72.
84. Bichrome I barrel-shaped jug with narrow, concave neck; collar-shaped mouth; handle from neck to shoulder. Concentric lines and bands on body. Height 30.3. As No. 72.
85. White Painted I shallow bowl with base-ring; two horizontal handles. Encircling lines and bands near rim and around base; six vertical, framed zigzag lines between these; a star ornament on base; around handles *tinged* bands; ladder-pattern on handles. Diam. 17.0. As No. 72.
86. White Painted I deep, funnel-shaped bowl with flat base and two horizontal handles. Encircling lines and bands round rim and base; vertical zigzag bands framed by parallel lines between these: concentric circles on base; broad black bands between concentric circles inside the bottom. Diam. 14.8. As No. 72.
87. Fragment of a White Painted I hemispherical bowl with round base; one horizontal handle preserved. Bands of ladder-pattern meeting in centre of base; concentric lines inside. Diam. c. 12.5. As No. 72.
88. White Painted I bowl, as No. 41. Encircling lines inside. Diam. 16.4. As No. 72.
89. White Painted I bowl with short stem; softly rounded outline, handle from rim to shoulder. Encircling lines outside and inside. Diam. 14.0. As No. 72.
90. White Painted I oval jug with base-ring, concave neck; pinched mouth; ridge around base of neck, handle from rim to shoulder. Encircling lines and bands on body; lattice triangles on shoulder. Height 17.5. As No. 72.
91. White Painted I tripod with concave neck and annular rim. A frieze of crosses, framed by parallel lines, around neck; on one leg two oblique chains of framed lattice lozenges and, in the triangular interspace between these, two zigzag lines enclosing a lattice triangle; on second leg a framed lozenge filled with lattice chequers; the third leg is covered with chequered lattice lozenges; transverse lines on rim. Height 14.7. As No. 72.
92. Black Slip I oval jug with base-ring; handle from neck to shoulder. Fluted body and three horizontal grooves around shoulder. Neck and handle missing. Height 14.1. As No. 72.
93. White Painted I large, ovoid amphora with base-ring; narrow, concave neck; flaring, flat rim; horizontal handles on shoulder. Encircling lines and bands on body and neck; wavy lines between handles; vertical lattice bands and band of hatched, contiguous triangles on shoulder. Height 35.5. As No. 72.
94. White Painted I large amphora, as No. 54, but with vertical, framed, latticed bands on shoulder. Height 46.1. As No. 72.
95. White Painted I large amphora, shape as No. 54. Encircling lines, bands, and wavy lines around body; two friezes of lattice lozenges and triangles on shoulder; neck covered with encircling, broad bands between concentric lines; transverse lines on rim; encircling lines inside neck. Height 44.4. As No. 72.
96. White Painted I large amphora, as No. 95. Height 55.5. As No. 72.
97. White Painted I large oval amphora with short, concave neck; swollen rim and two horizontal handles on shoulder. Encircling lines and bands; two pairs of lattice triangles on shoulder. Fragmentary. Height 44.0. As No. 72.
98. White Painted I large amphora, as No. 3, but without lines pendant from base of neck. Height 57.3. As No. 72.
99. White Painted I bowl, shape as No. 28. Below rim metope frieze of latticed, framed bands and tree-ornaments. Diam. 27.0. As No. 72.
100. Black Slip Painted I amphora with base-ring; concave neck; sloping rim; handles from neck to shoulder. Fluted body from shoulder to base; painted vertical, latticed bands on shoulder. Height 37.5. As No. 72.
101. Bronze pin, as No. 15 b. Length 13.5. In the dromos.
102. Fibula of bronze, as No. 16, but with two beads on bow. Length 5.3. In the dromos.

Summing up the classification given in the Object Register, we obtain the following diagram:

P o t t e r y										B r o n z e				Gold	Stone
Wh. P. I.	Bichr. I.	Bl. Sl. P. I.	Bl. Sl. Bichr. I.	Bl. Sl. I.	Pl. Wh. I.	Coarse W.	Pin	Fibula	Ring	Bowl	Nose-ring	Spindle-whirl			
3. 4. 5. 6. 7. 10. 11. 19	2. 12	100	79	8. 18	14. 48	13. 35	15 b	15 a	40	33	1	9			
21 22. 23. 24. 25. 26. 27. 28	20. 61.		80	56. 68	49. 71	43. 47	17 b	16							
29. 30. 31. 32. 34. 36. 37. 38	76. 82			92		52. 67	101	17 a							
39. 41. 42. 44. 45. 46. 50. 51	84					70		102							
53. 54. 55. 57. 58. 59. 60. 62															
63. 64. 65. 66. 69. 72. 73. 74															
75. 77. 78. 81. 83. 85. 86. 87															
88. 89. 90. 91. 93. 94. 95. 96															
97. 98. 99															
-67	-7	-1	-2	-5	-4	-7	-3	-4	-1	-1	-1	-1			

CHRONOLOGY

The pottery consists entirely of early specimens of Type I among which is one survival of a Mycenaean stirrup-vase: White Painted I, Bichrome I, Black Slip I, Black Slip Painted I, and Plain White I. The homogeneous pottery shows that a long time cannot have elapsed between the burials, which are dated by the pottery to the early part of Cypro-Geometric I.

TOMB 407 (Fig. 75: 1-4)

SIZE

	Length	Width	Depth	Height
Dromos	8.30	0.98	1.90	—
Stomion	0.20	0.98	—	c. 1.00 (fallen in)
Chamber	1.90	1.70	—	c. 1.00 (fallen in)

SHAPE

The dromos is a very long and narrow passage, nearly rectangular in plan with straight walls, narrowing slightly upwards above the door; the floor descends by a gentle slope to the door. The doorway fills up the whole width of the dromos, it has slightly curved roof and was closed by a packing of rough stones, the upper part of which had been removed. The door opens near the right end of the front wall of the chamber, and the floor of the dromos descends down to that of the chamber by a step. The chamber is nearly rectangular in plan with a slightly curved back wall. The right side wall, which separated this chamber from that of Tomb 412, has entirely collapsed. The floor of the chamber is approximately horizontal; the roof has partly fallen in and slopes towards the back wall.

At 2.75 m. from the entrance of the dromos there is a cutting in its left side wall at right angles to it; a set of stones lines this cutting.

STRATIFICATION

From the entrance of the dromos to the set of stones, the dromos-filling of *chavara* was mixed with a packing of rubble. Inside this set of stones there were remains of a burial (see below) covered with a filling of *chavara*. From there, the filling of the dromos consisted of layers of *chavara*, which were intact until just above the door, where a shaft had been dug by tomb-robbers who removed the upper part of the stone-packing, now missing, and refilled the shaft with mixed debris. In the chamber there was a disturbed layer of culture earth and debris at the bottom, worked through by the tomb-robbers, and a covering layer of infiltrated earth and *chavara*. Only three pots had been left by the robbers.

BURIALS

In the chamber itself the burial remains had been almost destroyed by the tomb-robbers, and only scattered bones were found in the filling.

In the dromos, on the other hand, intact remains of a burial were found inside the set of stones. Of the skeleton, the skull only was preserved. From the position of this skull — found to the left of the dromos edge — it is evident that the corpse was placed across the dromos along the set of stones; of the details of the position nothing for certain can be said. Tomb-gifts, in two pots, had been offered to the deceased.

FINDS (PL. XLV, 2)

1. Black-on-Red I (III) oval jug with base-ring; cylindrical neck; pinched mouth; twin-handle from rim to shoulder. Groups of concentric, intersecting circles on body. Height 20.8. Floor.
2. White Painted II oval jug with base-ring. Encircling lines round the body. Neck and handle missing. Height c. 20.0. Floor.
3. White Painted I plate with flat base and two horizontal handles. Much damaged. Diam. 22.0. Floor.
4. Coarse biconical, depressed jug with base-ring; wide, pinched mouth; handle from rim to shoulder. Height 11.3. Floor.
5. White Painted I plate, as No. 3. Encircling lines and concentric circles inside the bottom; four lattice triangles meeting in a dot on base. Diam. 21.2. Floor.

Summing up the classification given in the Object Register, we obtain the following diagram:

	P o t t e r y			
	Wh P I	Wh P. II	Bl-on-R I (III)	Coarse W.
Chamber	3, 5 -2			4 -1
Dromos		2 -1	1 -1	

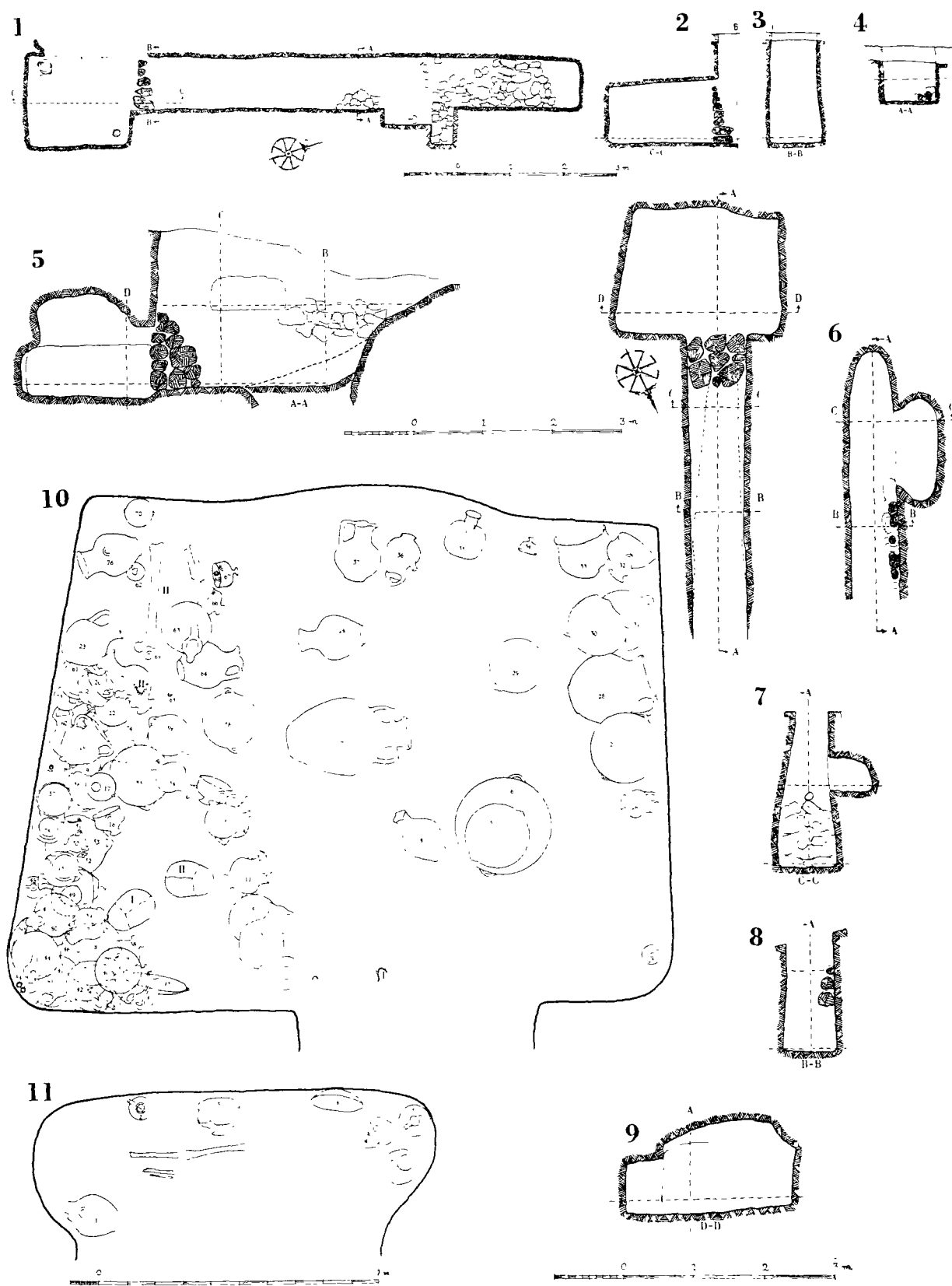

Fig. 75. Lapithos. Tomb 407, Plan (1); Sections C-C, B-B, A-A (2—4). Tomb 408, Plan (6); Sections A-A, C-C, B-B, D-D (5, 7—9); Finds in chamber (10); Finds in niche (11).

CHRONOLOGY

The classification of the pottery and the potsherds found in the disturbed layers of the tomb indicate that the burial in the chamber dates from Cypro-Geometric I: the few preserved pots are of White Painted I Ware and the potsherds consisted of White Painted I, Black Slip I, and Plain White I, so far as the shapes could be recognized.

The burial in the dromos, on the other hand, dates from the beginning of Cypro-Geometric III, as proved by the two pots of White Painted II and Black-on-Red I (III) deposited there. Consequently it is a post-burial, which took place a long time since the tomb was used.

TOMB 408 (Fig. 75: 5—11)

	SIZE			
	Length	Width	Depth	Height
Dromos	4.25	0.84	2.25	—
Stomion	—	0.84	—	0.90
Chamber	1.95	2.35	—	0.80

SHAPE

The dromos is a narrow passage of medium size; approximately rectangular in plan with walls closing in towards the door. The middle part of the floor has collapsed into a cavity in the rock, but the original level is clearly marked on the side walls, indicating that the floor originally sloped rather steeply down towards the door. An oval niche is cut in the right side wall 1.05 m. above the floor of the dromos, and the whole front side opens on to the dromos. The floor is horizontal and its roof curved. It was not found closed, but a set of stones lined the right wall of the dromos to the North of the niche and on a level with it.

The doorway fills up the whole width of the dromos. It has straight sides and a nearly flat roof, and was closed by a packing of rough stones. It opens on to the chamber to the right of its longitudinal axis and the floor of the dromos descends to that of the chamber by a gentle slope. The chamber is trapezoid in shape, with the side walls closing in towards the back, and rounded front corners. The floor slopes slightly towards the door and right side wall. The roof originally sloped towards the back wall but a great part of it has fallen in, leaving an irregular cavity in the centre.

STRATIFICATION

The filling of the dromos consisted of intact layers of *chavara*. In the chamber was a burial and culture stratum on the floor: above this, were different layers of rock material from the collapsed roof, and earth and *chavara* brought in from the dromos by rain-water. These intrusive layers filled the chamber to the roof, and many of the pots had been

moved up and down in them by the water and were, therefore, not *in situ*. Some were found piled up along the left long side and others were found at different levels in the upper, silted layers. Naturally, these different levels are of no conclusive, chronological value: all the finds in the chamber belong to one burial period.

In the niche there was a single burial stratum on the floor, covered by a layer of weathered rock. All the finds were found on the floor.

BURIALS

There were the remains of two bodies buried in the chamber. One body had been placed in the longitudinal axis of the chamber, probably in an outstretched, dorsal position with the head towards the door, but of the skull, only the lower jaw was found approximately *in situ*, while the whole of the remainder had been removed to the left front corner. The second skeleton was found along the left side wall. The skull, one femur, and parts of a fibula and tibiae were preserved, but not *in situ*. The first body had been adorned with a finger-ring of gold (No. 1), and the second with finger-rings of bronze (Nos. 68, 77, 84) and with earrings of gilded bronze (No. 65); the dress of this body was fastened with a fibula of bronze (No. 51).

In the niche remains of a single skeleton were found with the skull, the right femur, the right tibia, a part of the left tibia and fibula preserved. From the position of the bones it can be inferred that the legs were not bent. As the length of the niche is too small to allow an outstretched position of the body it seems likely that it had been placed half sitting with the back leaning against the right side wall.

FINDS (GROUPS: PL. XLVI, 2—4; TYPES: L. OF PL. II)

C h a m b e r

1. Finger-ring of thin gold with a ridge around the circlet. Diam. 2.0. Floor.
2. Black Slip I conical jug with low foot, concave neck; sloping, pinched mouth; handle from rim to shoulder. Fluted body; ridge around base of neck. Height 16.3. Floor.
3. White Painted II oval jug with base-ring; slightly concave neck; pinched mouth; handle from rim to shoulder. Encircling lines and bands round rim, neck, shoulder, belly, and base; groups of pendant, short lines from base of neck; a zigzag line along handle. Height 22.9. — 1.
4. Black Slip II oval jug with base-ring; concave neck, widening upwards; pinched mouth; handle from rim to shoulder. Fluted body and four grooved lines round shoulder. Height 21.0. — 6.
5. Bichrome II plate with flat base and two knobbed, horizontal handles. Concentric circles inside; encircling lines and bands around base; four lattice triangles meeting in concentric bichrome circles on base. Diam. 22.8. In No. 6.
6. White Painted I plate with flat base and two horizontal handles. Decoration of encircling lines and bands,

- four lattice triangles meeting in a circle on base. Diam. 34.5. — 10
7. White Painted I oval amphora with base-ring, narrow, concave neck; flaring, ridged rim; knobbed handles from neck to shoulder. Encircling lines and bands round rim, neck, shoulder, belly, and base; framed vertical zigzag lines and lattice triangles round shoulder; ladder-pattern on handle. Height 44.0. Floor.
8. White Painted I plate with flat base and two horizontal handles. Encircling lines and concentric circles inside; encircled, hatched maltese cross on base. Diam. 18.1. Floor
9. Nearly hemispherical bronze bowl with round base and profiled rim. Diam. 16.0. On Nos. 10, 38, 40, 42.
10. White Painted I amphoriskos with low foot, depressed pear-shaped body; wide, slightly concave neck; handles from rim to shoulder. Encircling band round base of neck. Height 12.3. \pm 0.
11. White Painted I amphoriskos, as No. 10. Encircling lines and bands round rim, neck, and belly; foot covered with black paint, transverse lines on rim; ladder-pattern on handles. Height 14.9. — 10.
12. White Painted II spherical jug with round base; con-

- cave neck with handle-ridge; funnel-lip; handle from neck to shoulder. Encircling lines and bands round rim and neck; wheel-ornament inscribed in concentric circles on both sides of body; one encircled spiral below and another opposite the handle; ladder-pattern on handle. Height 18.0. — 8.
13. White Painted I bowl with low foot; softly curved outline; two horizontal handles near rim. Encircling bands round rim, body, and base. Diam. 12.5. — 8.
14. Plain White I depressed ovoid jug with low foot; slightly concave neck; annular rim; handle from neck to shoulder. Height 14.3. — 10.
15. White Painted II amphoriskos, shape as No. 10, but with cylindrical neck; decoration as No. 11, but rim covered with black paint. Height 14.5. + 9.
16. White Painted I bowl, as No. 13. Diam. 10.1. + 7.
17. White Painted I bowl, as No. 13. Handles missing. Diam. 10.0. — 4.
18. White Painted I amphoriskos, as No. 10. Encircling lines and bands round rim, neck, belly, and base; parallel zigzag lines on shoulder; groups of transverse lines on rim and wavy lines along handles. Height 15.3. — 2.
19. White Painted I lentoid jug with narrow, concave neck; flaring rim; handle from neck to shoulder. Encircling lines round neck; bands and lines of concentric circles on both sides of body. Height 13.0. On Nos. 56 and 74.
20. Coarse oval jug with base-ring; short concave, wide neck; pinched mouth; handle from rim to shoulder. Height 13.0. In No. 21.
21. White Painted I bowl with low foot; softly curved outline; handle from rim to body. Encircling lines and bands round rim and base; two wavy lines round body. Diam. 12.4. — 2.
22. Black Slip I jug with low, wide foot; oval body; slightly concave neck; pinched mouth; handle from rim to shoulder. Fluted body. Height 18.1. — 6.
23. White Painted II jug, as No. 3. Height 22.0. — 4.
24. Black Slip II oval jug, as No. 4, but with slimmer body. Three horizontal grooved lines on shoulder. Height 22.0. Floor.
25. White Painted II jug with flat base; dome-shaped body; narrow, concave neck; handle from neck to shoulder. Decoration of encircling lines. Much worn. Mouth missing. Height 6.9. Floor.
26. Plain White I jug, as No. 14. Height 14.4. Floor.
27. White Painted I bowl, as No. 13. Diam. 25.5. Floor.
28. Coarse oval jug with base-ring; short, wide, cylindrical neck; handle from rim to shoulder. Height 28.8. Floor.
29. White Painted I plate, shape as No. 8, but with wide base. Encircling lines and bands, five lattice triangles meeting in an encircled cross on base. No decoration inside. Diam. 20.3. Floor.
30. White Painted I plate, shape as No. 8. Encircling lines and a spiral inside; framed lattice chequers forming a secondary cross with a central, latticed square on base; broad band and lines around base. Diam. 22.0. Floor.
31. White Painted I plate, as No. 30. Diam. 21.5. Floor.
32. White Painted I bowl, as No. 13. Diam. 18.0. Floor.
33. White Painted I bowl, shape as No. 13. Encircling bands round rim, body, and base; metope decoration of framed, vertical latticed bands around body. Diam. 20.9. Floor.
34. White Painted I bowl, as No. 13. Diam. 6.9. Floor.
35. Bichrome II spherical jug, shape and decoration similar to No. 12, but with an inscribed maltese cross on both sides of body. Height 18.6. Floor.
36. White Painted I depressed jug with low, wide foot; concave neck; splaying rim; tubular spout; basket-handle. Encircling lines and bands round rim, neck, spout, and belly; lower part of the body covered with black paint, framed lattice triangles on shoulder; ladder-pattern on handle. Height 19.2. Floor.
37. White Painted II oval jug, as No. 3. Height 20.3. Floor.
38. White Painted I amphoriskos, shape as No. 10, and decoration as No. 11, but without encircling lines round belly. Height 13.0. Floor.
39. Plain White II jug, as No. 14. Height 15.9. Floor.
40. White Painted I bowl, as No. 13. Height 7.7. In No. 46.
41. Bichrome II spherical jug, as No. 35. Height 19.4. On Nos. 46, 81.
42. White Painted I oval jug with base-ring; concave neck; pinched mouth; handle from rim to shoulder. Encircling lines round rim, neck, and shoulder; lower part of the body covered with black paint; three framed lattice triangles on shoulder, and a zigzag line along handle. Height 24.6. On Nos. 40, 41, 46, 82.
43. Plain White I amphoriskos, shape as No. 10. Height 14.1. Floor.
44. White Painted I jug, as No. 42, but with ladder-pattern on handle. Height 17.3. Floor.
45. White Painted I plate, shape as No. 8. Encircling lines and a spiral inside; base covered with four lattice triangles divided by crossed lines; broad band and lines around base. Diam. 22.0. Floor.
46. White Painted I plate, shape as No. 8. Encircling lines and a spiral inside; rosette-ornament of filled bands radiating from a central dot on base; broad bands and lines around base. Diam. 22.0. Floor.
47. White Painted II jug, as No. 3, but with three wavy lines round neck. Height 25.6. Floor.
48. White Painted II jug, shape as No. 12. Encircling lines round rim and neck; four groups of concentric circles on body; ladder-pattern on handle. Height 13.0. Floor.
49. Roughly circular limestone cover of a jar with a projection to fit into the neck. Diam. 18.0. Floor.
50. Black Slip I amphoriskos with low foot; depressed body; wide, slightly concave neck; handles from rim to shoulder. Fluted body. Height 7.2. In No. 53.
51. Bronze fibulae.
 a) Arc-shaped fibula, slightly beaded. Pin missing. Length 4.6
 b) Fibula with angular bow, flattened fore-end, and single-coiled spring. Pin and lower part of bow missing. Length c. 5.7.

- c) Fibula, shape as b, but with double-coiled spring. Pin broken. Length 4.5.
- d) Fibula with thin, angular bow and a large, flat catch. Pin and spring broken. Length 6.2. In No. 53.
52. Astragalus. Length 2.85. In No. 53.
53. White Painted I plate, shape as No. 30, but on base framed lattice chequers forming a secondary cross with a filled square in centre. Diam. 22.0. Floor.
54. Black Slip I globular amphoriskos with low foot; narrow, concave neck; splaying rim; two knobbed handles from neck to shoulder. Fluted body. Height 15.7. Floor.
55. White Painted I plate, as No. 30. Diam. 22.0. Floor.
56. White Painted II plate with wide base-ring and two horizontal handles. Concentric circles inside; on base a rich decoration of latticed and chequered triangles on each side of a framed band of dotted lozenges; groups of transverse strokes on base-ring; encircling band around base. Diam. 15.9. Floor.
57. White Painted I bowl, as No. 13. Height 9.5. Floor.
58. White Painted I plate, shape as No. 8. Encircling lines and concentric circles inside; four framed lattice triangles meeting in a lattice square on base; encircling lines and bands around base. Diam. 19.9. Floor.
59. White Painted I plate with raised base, one horizontal handle and shaft opposite the handle. Encircling lines and a spiral inside; an encircled, hatched maltese cross on base. Diam. 15.0. Floor.
60. White Painted II jug, similar to No. 36, but with slimmer body and narrow neck. Height 19.8. Floor.
61. White Painted I amphoriskos, shape as No. 10. Encircling lines round rim, neck, and base; transverse lines on rim; ladder-pattern on handles. Height 18.0. Floor.
62. White Painted II depressed spherical jug with short, narrow, concave neck; collar-shaped mouth; handle from neck to shoulder. Encircling lines and bands round rim, neck, and belly; framed lattice triangles on shoulder; a filled maltese cross on base; ladder-pattern on handle. Height 7.5. Floor.
63. White Painted I jug, as No. 42, but with low foot and groups of pendant lines from base of neck. Height 23.7. Floor.
64. White Painted II jug, as No. 3. Height 21.3. Floor.
65. Circular earring of gilded bronze. Diam. 1.8. Floor.
66. White Painted I bowl, as No. 13. Height 7.0. Floor.
67. White Painted I bowl, as No. 13. Height 7.0. Floor.
68. Several bronze fragments of small, circular finger-rings. In No. 67.
69. Plain White I depressed miniature jug with round base; narrow, concave neck; splaying rim; handle from neck to shoulder. Height 5.3. Floor.
70. White Painted I bowl, as No. 13. Height 7.2. Floor.
71. White Painted I jug, similar to No. 63, but with ovoid, depressed body. Height 23.9. Floor.
72. White Painted I amphoriskos, shape as No. 10. Encircling lines round rim, neck, and belly; transverse lines on rim; ladder-pattern on handle; a frieze of lattice lozenges on neck; zigzag bands round shoulder. Height 10.7. Floor.
73. White Painted II spherical jug with narrow, concave neck; funnel-mouth; two handles from neck to shoulder. A filled maltese cross inscribed in concentric circles on both sides of body; ladder-pattern on handles. Height 13.2. Floor.
74. White Painted I amphora, shape as No. 10. Encircling lines round rim and neck; body near foot covered with black paint, groups of transverse lines on rim; metope decoration of a framed lozenge-ornament filled with lattice chequers forming a secondary cross with a filled, central square and flanked by two vertical lattice bands. Height 24.6. Floor.
75. Coarse oval jug, similar to No. 28, but with concave neck. Height 10.4. Floor.
76. White Painted I oval amphora with base-ring; concave neck; splaying rim; two horizontal handles on shoulder. Broad bands with encircling lines between around neck; encircling bands around shoulder, belly, and base; metope decoration of latticed hour-glass ornament framed by parallel lines on shoulder. Height 43.6. Floor.
77. Plain, circular finger-ring of bronze with flat section. Diam. 1.6. Floor.
78. White Painted I bowl with conical foot; softly curved outline; rim raised into a short, wide, cylindrical neck; two horizontal handles on body; a miniature bowl perched on one handle. Encircling lines round rim, body, and base; two wavy lines round body; metope decoration of filled hour-glass ornaments framed by vertical lines around rim. Height 13.7. Floor.
79. White Painted II jug, as No. 3. Height 19.8. Floor.
80. Bichrome II depressed oval jug with low foot; concave neck; round mouth with swollen rim; handle from neck to shoulder. Encircling lines and bands round rim, neck, belly, and base; ladder-pattern on handle. Height 14.8. Floor.
81. Black Slip I oval amphora with base-ring; concave neck; two knobbed handles from neck to shoulder. Fluted body. Height 23.0. Floor.
82. White Painted I askos on three legs, with cylindrical spout; an animal's protome on shoulder; a basket-handle between spout and protome. Encircling lines and bands; groups of chevrons round belly; triangles filled with lattice chequers on shoulder; ladder-pattern on handle. Height 12.0. Floor.
83. White Painted I plate, shape as No. 8. Encircling lines; a filled maltese cross inscribed in concentric circles inside the bottom; framed, latticed chequers on base; bands of lattice lozenges framed by filled triangles and parallel lines on body. Diam. 14.3. Floor.
84. Two bronze finger-rings with overlapping ends, and flat section. Diam. 1.5; 1.6. Floor.

N i c h e

1. White Painted II amphora with base-ring; ovoid body; slightly concave neck; two horizontal handles on shoulder.

TOMB 409 (Figs. 74; 76: 1—4)

SIZE

	Length	Width	Depth	Height
Dromos	8.30	1.05	2.50	—
Stomion	—	1.05	—	c. 1.05
Chamber	2.70	3.40	—	c. 1.05

SHAPE

The dromos is a very long and narrow passage, nearly rectangular in plan with walls tapering upwards slightly; the floor descends gently at first but more steeply towards the door. The doorway occupies the whole width of the dromos. It has slightly curved sides and the roof, which is damaged, seems to have been curved. The door-packing, consisting of rough stones, was not intact, and only closed the upper part of the doorway; it was not founded on the rock floor but in the filling of the dromos. The door opens on to the chamber to the right of its longitudinal axis and the floor of the dromos in front of the door is on a level with that of the chamber. The chamber is trapezoid in plan, with straight front and right side, and oblique back and left side. The corners are rounded. The floor is horizontal and the roof has also been approximately horizontal, but a large part of it has fallen in.

STRATIFICATION

The filling of the dromos consisted of homogeneous layers of *chavara* in front of the door interrupted by a wedge-shaped layer of darker, disturbed earth. In this mixed layer, the door-packing was founded, closing only the upper part of the door (cf. above). This mixed layer and the disturbed door-packing indicated that the tomb had been visited by tomb-robbers, and this was verified by the circumstances of finds in the chamber itself. The layers in the chamber comprised disturbed layer of burial earth at the bottom, covered by a heavy layer of rock debris from the collapsed roof, and infiltrated layers of earth and silted clay brought in by the rains. These layers were intact, which proves that the robbery had taken place before the roof collapsed. The robbers had left some pots, bronzes and a little gold, showing that they had done their work rather carelessly.

BURIALS

As stated above no intact remains of burials were found. Among the tomb-gifts a bronze statuette of a goat (No. 3), a bronze crook for a shepherd's staff (No. 12) and different tools of bronze and iron should be noted.

FINDS (GROUPS: PL. XLVII, 1—4; TYPES: L. OF PL. II)

1. A pair of gold earrings of the boat-shaped type, but only slightly swollen below, and with overlapping ends. Diam. 3.0. Floor.
2. Plain, circular finger-ring of thin gold. Diam. 2.1. Floor.
3. Small statuette of bronze representing a goat with cy-

- lindrical body; short straight legs; short tail turned upwards, short, rounded nose; two backwards-curved horns. Length 4.2. Floor.
4. White Painted I open bowl with low foot; softly curved outline; two horizontal handles. Encircling bands round rim and body. Height 10.5. Floor.
5. Iron knife with slightly curved blade; one cutting edge; pointed end; a flat tang, pierced by two rivets. Traces of a wooden handle still visible. Length 17.3. Floor.
6. Fragment of tang of iron sword. Length 6.5. Floor.
7. Iron pike, narrowing towards the pointed end; of circular section. Middle part missing. Length of upper part 13.0. Length of lower part 15.9. Floor.
8. White Painted I miniature jug with squat body; round base; narrow, concave neck; splaying rim; handle from neck to shoulder. Encircling lines and an encircled, filled maltese cross on base; ladder-pattern on handle. Height 8.0. — 60.
9. Fragments of a shallow, rounded bronze bowl. Diam. 15.0. Floor.
10. Double-folded, rectangular mounting of bronze, with rounded profile; pierced at the edges by rivets. Probably used for strengthening the edge of a wooden bowl. Length 5.9. Floor.
11. White Painted I bowl, similar to No. 4, but shallower, and with one handle from rim. Encircling bands and two wavy lines round the body. Diam. 13.6. Floor.
12. Bronze socket of a shepherd's crook, with two rivet-holes near mouth of socket. Length 17.5. Floor.
- 13 a) Plain, flat, circular finger-ring of bronze. Diam. 1.9.
b) Fragment of a bronze fibula with arc-shaped, beaded bow. Pin, catch, and spring missing. Length 4.4. Floor.
14. A single-coiled finger-ring of bronze with overlapping ends. Diam. 1.9. Floor.
15. Bronze fibula with slightly angular fore-end, and single-coiled spring. Pin and catch missing. Length 5.7. Floor.
16. Iron fragment. Length 6.2. Floor.
- 17 a) Leaf-shaped iron knife with one cutting edge; pointed end; narrowing top. Traces of wood still visible on the top end of blade. Length 8.5.
b) Fragment of iron knife. Length 7.0. Floor.

Summing up the classification given in the Object Register we obtain the following diagram:

Pottery		I r o n			B r o n z e					G o l d					
Wh.	P. I	Pike	Knife	Fragment	Shepherd's crook	Fibula	Ring	Mounting	Bowl	Statuette	Earring	Finger-ring			
4.	8.	11	7	5.	17 a	6.	16	12	13 b	13 a	10	9	3	1	2
					17 b				15	14					
		-3	-1	-3	-2	-1	-1	-2	-1	-1	-1	-1	-1	-1	-1

CHRONOLOGY

The three pots found are of White Painted I Ware but among the potsherds on the floor were also specimens of Type II: White Painted II and Bichrome II Wares, indicating that the tomb dates from Cypro-Geometric II.

TOMB 410 (Fig. 76: 5—10)

	SIZE			
	Length	Width	Depth	Height
Dromos	8.20	1.03	2.64	—
Stomion	0.30	0.90	—	0.80—0.90
Chamber	2.50	2.00	—	c. 0.90
Niche	1.62	2.20	—	1.10

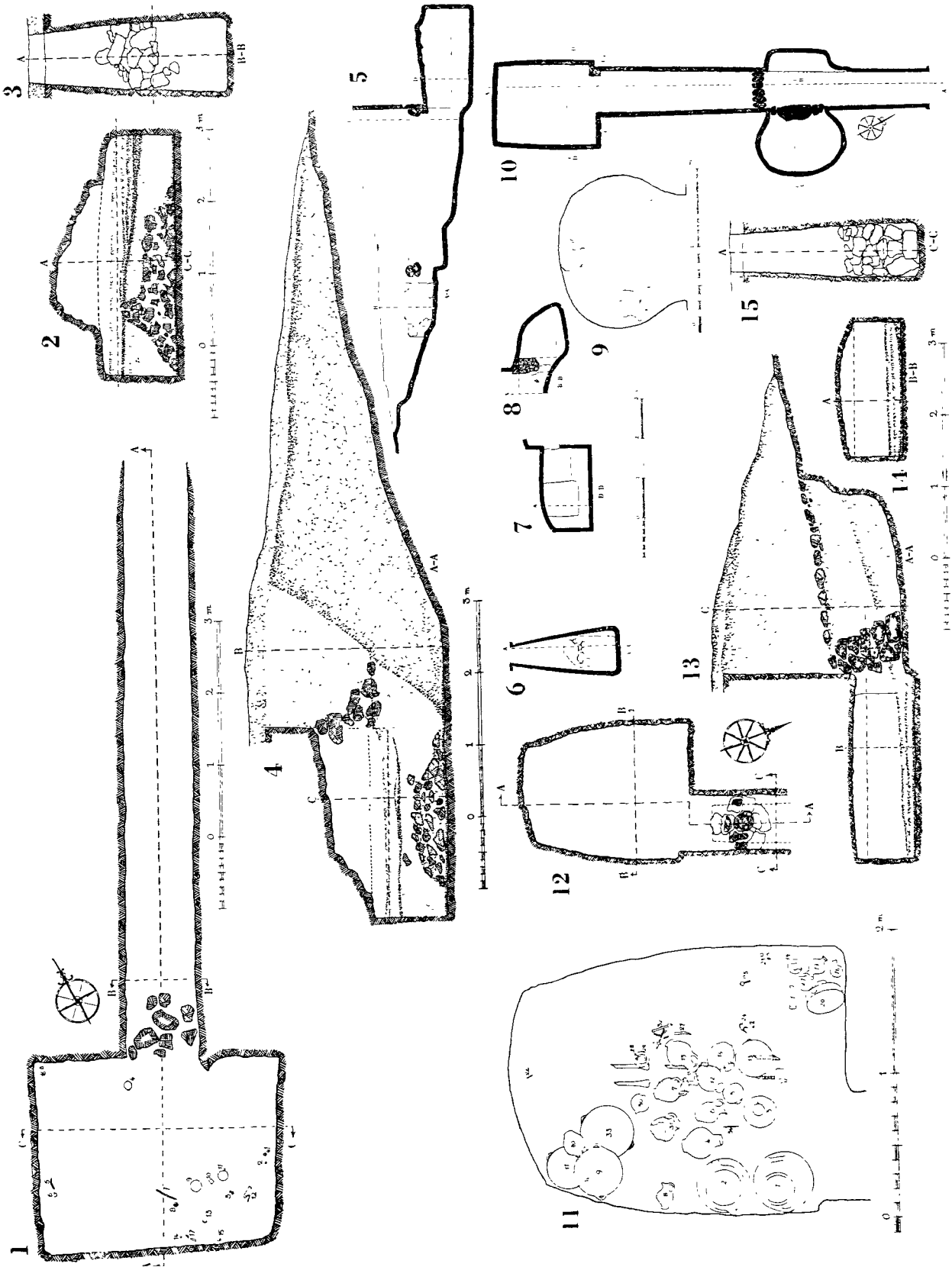

Fig. 76. Lapithos. Tomb 409, Plan (1); Sections C-C, B-B, A-A (2-4). Tomb 410, Plan (10); Sections A-A, C-C, D-D, B-B (5-8); Finds in niche (9). Tomb 411, Plan (12); Sections A-A, B-B, C-C (13-15); Finds *in situ* (11).

SHAPE

The dromos is a very long and narrow passage, with slightly curved side walls, tapering upwards near the back part of the dromos. The floor of the dromos descends by four wide and worn steps to a sloping area in front of the door. At a distance of 2.60 m. from the opening of the dromos a cave-shaped niche is cut in the left rock wall. It was closed by one large, roughly cut block of stone surrounded by rubble. The floor of the dromos descends to that of the niche by a rather steep slope. The floor of the niche rises towards the back wall and the roof is arched. Opposite the niche is a shallow cutting in the right rock wall perhaps made in order to facilitate the cutting of the niche in the narrow space of the dromos. On the right side of the opening of the niche, there was a wall of rubble built across the dromos, dividing the part with the niche from the rest of the dromos. The doorway has straight sides closing in slightly at the top and a slightly arched roof. The door-packing, consisting of rough stones, was not intact, and only closed the top of the door. The stomion is short, and rectangular in plan; it opens on to the chamber to the right of its longitudinal axis and the floor descends to the level of the chamber by a sloping step. The chamber is roughly rectangular in shape with slightly curved side walls. The floor is horizontal. The roof slopes towards the right wall and has partly fallen in. The upper part of the left wall separating this chamber from that of Tomb 415 has collapsed, so that the two chambers communicate.

STRATIFICATION

In the filling of the dromos, consisting of layers of *chavara*, a wedge-shaped shaft had been dug in front of the door and refilled again with mixed debris. This, and the removed door-packing, indicate that the tomb had been visited by tomb-robbers, which was confirmed by the circumstances of finds and the stratification in the chamber itself: a culture stratum and a layer of infiltrated earth from the dromos, with stones from the door-packing, were mixed together and thoroughly turned over by the tomb-robbers. Masses of potsherds were found in this filling and some Byzantine potsherds date the robbery.

BURIALS

The skeletal remains in the chamber had been destroyed by the tomb-robbers and were found scattered about in the filling. The niche was intact, but did not contain any remains of skeletons, only a deposit of six vases.

FINDS (GROUP: PL. XLVII, 5; TYPES: L. OF PL. II)

Niche

1. Bichrome III spherical jug with raised base; narrow neck with handle-ridge, funnel-shaped mouth; handle from neck to shoulder. Bichrome encircling lines and bands round rim and neck; concentric lines and bands on both sides of body, and three groups concentric circles opposite the handle. Height 11.2. Floor.
2. Black-on-Red I (III) deep, open bowl with base-ring; angular outline; straight, splaying sides; two horizontal handles. Encircling bands round rim, body, and base-ring; concentric circles inside. Height 11.0. Floor.
3. White Painted III oval amphora with base-ring; concave neck; swollen rim, two horizontal handles on belly. Encircling lines and bands round rim, base, shoulder, and

- belly; neck covered with broad bands and encircling lines; on shoulder groups of vertical lines and an ornament of a winged, filled lozenge inscribed in a triangle of parallel lines. Height 49.5. Floor.
4. Black-on-Red I (III) oval hydria with base-ring. Encircling lines and bands round neck, shoulder, and belly; framed zigzag line along the vertical handle; concentric circles inscribed in a triangle below this handle and three groups of concentric circles on shoulder. Upper part of neck missing. Height 43.0. Floor.
5. Black-on-Red I (III) oval jug with base-ring; short, concave neck; pinched mouth; twin-handle from rim to shoulder. Encircling lines round rim, neck, and base-ring; two wavy lines on neck; concentric, intersecting circles on body. Height 21.7. Floor.
6. Black-on-Red I (III) jug, as No. 5. Height 21.7. Floor.

Summing up the classification given in the Object Register, we obtain the following diagram:

P o t t e r y		
Wh. P. III	Bichr. III	Bl.-on-R. I (III)
3	1	2. 4. 5. 6
-1	-1	-4

CHRONOLOGY

The potsherds found in the disturbed layers of the chamber are entirely of Type I: White Painted I, Black Slip I, and Plain White I. Some potsherds are late in style, assigning the tomb to the later part of Cypro-Geometric I.

The pottery found in the niche, as shown by the diagram, is entirely of Type III: White Painted III, Bichrome III, Black-on-Red I (III). The types are late in style and the niche burial dates, therefore, from the end of Cypro-Geometric III.

TOMB 411 (Fig. 76: 11—15)

SIZE

	Length	Width	Depth	Height
Dromos	4.20	0.75	2.47	—
Stomion	0.30	0.75	—	0.82
Chamber	2.25	1.88	—	0.87

SHAPE

The dromos is short and narrow, nearly rectangular in plan with side walls narrowing slightly upwards. Its floor does not slope gradually, but descends abruptly forming a basin-shaped shaft in front of the door. The door fills the whole width of the dromos. It has straight sides and nearly flat roof, and was closed by a packing of rough stones. It opens on to the chamber near the left end of its front wall, and the floor of the dromos descends down to that of the stomion, which is on a level with that of the chamber, by a vertical step. The chamber is spade-shaped in plan with curved side and back walls. The floor is horizontal and the roof is arched, sloping towards the side walls.

STRATIFICATION

The filling of the dromos consisted of two layers of homogeneous *chaxara*, separated by a layer of rubble extending all over the dromos on a level with the uppermost stones of the door-packing and probably placed there in order to strengthen the filling. In the chamber there was a single burial and culture stratum on the floor, covered by an upper layer of weathered rock and infiltrated earth and *chaxara* brought in by the rains. All the objects were found on the floor.

BURIALS

A single body had been buried in the tomb of which preserved remains of parts of the skull, spinal column, upper right humerus, the femora and tibiae were found, in a dorsal, outstretched position along the longitudinal axis of the chamber with the head towards the front wall. The body was male. Its dress had been fastened by a fibula of bronze and pins of bronze, iron, and bone (Nos. 22, 23, 24, 25, 26). Beside the tomb-gifts in the usual stock of vases, there were also iron tools of different kinds (Nos. 27, 32 a—c), all indicating that the deceased was a man. The vases were placed along the left wall around the skeleton and in the right front corner of the chamber.

FINDS (GROUPS: PL. XLVIII, I, 2; TYPES: L. OF PL. II)

1. White Painted I oval amphora with base-ring; concave, short neck; swollen, splaying rim; horizontal handles on shoulder. Encircling lines and bands round rim, neck, shoulder, belly, and base; two wavy lines round belly; lattice triangles round shoulder. Height 49.5. Floor.
2. White Painted II pyriform amphora with short, stemmed foot; wide, slightly concave neck; splaying rim; handles from rim to shoulder. Encircling lines and bands round rim, neck, and shoulder; foot covered with black paint; framed zigzag lines along handles; metope decoration of framed bands of lattice lozenges on neck. Height 47.8. Floor.
3. White Painted II spherical jug with round base; narrow, concave neck with handle-ridge; funnel-shaped mouth; handle from neck to shoulder. Concentric circles on both sides of body; a band of latticed, winged lozenges below and opposite the handle. Height 30.1. Floor.
4. Plain White II ovoid jug with base-ring; short, slightly concave neck, annular rim; handle from neck to shoulder. Height 25.0. Floor.
5. White Painted I jug, as No. 3, but with collar-shaped mouth. Upper part of mouth missing. Height 17.6. Floor.
6. White Painted II oval jug with base-ring; short, slightly concave neck; pinched mouth; handle from rim to shoulder. Encircling lines and bands round rim, neck, shoulder, belly, and base; lattice triangles on shoulder. Decoration worn. Height 21.0. Floor.
7. Black Slip II oval amphora with depressed ovoid body; base-ring; concave neck; splaying rim; two handles from neck to shoulder. Fluted body and horizontal grooved lines around shoulder. Height 23.1. Floor.
8. Black Slip I depressed pyriform jug with low foot; concave neck; pinched mouth; handle from rim to shoulder. Fluted body. Height 17.9. Floor.
9. White Painted I plate with flat base and two horizontal handles. Encircling lines and concentric circles inside; six lattice triangles meeting in concentric circles on base, encircled by bands and lines. Diam. 34.0. Floor.
10. Black Slip II oval jug with base-ring; nearly cylindrical neck; pinched mouth; handle from rim to shoulder. Fluted body and horizontal, grooved lines around shoulder. Height 23.6. Floor.
11. White Painted II deep, open bowl with short, stemmed foot; angular outline; two horizontal handles. Encircling bands round rim and body; foot covered with black paint; metope decoration of crossed lines framed by parallel lines between rim and belly. Diam. 29.0. Floor.
12. Plain White II oval jug with raised, flat base; short, concave neck; handle from neck to shoulder. Part of neck missing. Height 24.4. Floor.
13. White Painted I deep bowl, similar to No. 11, but with low foot and sotter outline; vertical bands of lattice lozenges and triangles framed by parallel lines between rim and belly. Diam. 25.5. Floor.
14. Bichrome I spherical jug with short, narrow, concave neck; concave, collar-shaped mouth; handle from neck to shoulder. Bichrome encircling lines round rim and neck; concentric circles on both sides of body; a framed zigzag line along handle; bands of latticed, winged lozenges below and opposite the handle. Height 24.0. Floor.

15. White Painted I depressed oval jug with low foot; short, concave neck; pinched mouth; handle from rim to shoulder. Encircling lines round rim, shoulder, and belly; bands round base of neck and foot; wavy lines round neck; groups of short strokes pendant from neck; framed zigzag band along handle. Height 25.0. Floor.
16. White Painted I spherical jug with round base; short, narrow, concave neck; swollen lip; handle from neck to shoulder. Decoration effaced. Height 12.1. Floor.
17. Black Slip I jug, as No. 8, but with depressed oval body. Three horizontal, grooved lines round shoulder. Foot missing. Height 15.4. Floor.
18. Eichrome I oval jug, shape as No. 15. Encircling lines and bands round rim, neck, and belly; foot and lower part of body covered with black paint; three framed lattice triangles on shoulder; ladder-pattern on handle. Mouth chipped. Height 14.6. Floor.
19. Black Slip I—II globular jug, similar to No. 17, but with nearly cylindrical neck. Four horizontal, grooved lines around shoulder. Height 14.5. Floor.
20. White Painted I deep, open bowl, shape as No. 13. Encircling bands round rim and body; foot covered with black paint; metope decoration of framed latticed bands flanking an ornament of lattice chequers. Diam. 27.5. Floor.
21. Fragment of a hemispherical bronze bowl. Floor.
22. a) Bronze fibula, similar to No. 24. The angular fore-end, spring, and pin missing. Length 4.5.
b) Fragment of a bronze fibula. Length 2.8. Floor.
23. a) Flat, circular finger-ring of bronze with overlapping ends. Diam. 2.5.
b) Bronze fibula, shape as No. 24. Spring, catch, and pin missing. Length 4.5. Floor.
24. Bronze fibula with beaded bow; angular, flattened fore-end; single-coiled spring; broad catch; straight pin. Length 5.3. Floor.
25. Iron pin with ivory head in shape of a pomegranate. Pointed end of pin, and half of head missing. Length 6.9. Floor.
26. Fragment of straight pin of ivory with pointed end. Upper part missing. Length 4.1. Floor.
27. Iron knife with curved blade; one cutting edge, pointed end; a flat tang with two rivets. Traces of wood still visible on the tang. Length 12.1. Floor.
28. Coarse oval jug with flat base; short neck; pinched mouth; handle from rim to shoulder. Height 7.3. Floor.
29. White Painted II open bowl with base-ring; rather straight sides; plain rim; two horizontal handles. Encircling lines round rim, body, and base; concentric circles inside. Diam. 11.1. Floor.
30. White Painted I bowl, as No. 13, but with one vertical handle from rim to body. Encircling bands round rim, body, and base. Diam. 12.2. Floor.
31. Coarse oval jug with flat base; short, wide neck; handle from rim to shoulder. Damaged. Height 17.1. Floor.
32. a) Long narrow pike of iron with pointed end; circular in section. Point missing. Length 23.7.
b) Iron pike, as No. 32 a, but with a disc-guard fixed to the middle of the pike. Piece of disc and point missing. Length 24.8.
c) Iron pike, as No. 32 b. Broken below disc. Length 15.0. Floor.
33. White Painted II large plate, similar to No. 9, but decorated with encircling lines and concentric circles inside; three lattice triangles meeting in a wide, central ornament on base; encircling lines and bands round base. Diam. 37.0. Floor.
34. Straight, thin bronze pin, with pointed end. Upper part missing. Length 10.1. Floor.

Summing up the classification given in the Object Register, we obtain the following diagram:

Pottery								Iron				Bronze		Ivory	
Wh. P. I	Wh. P. II	Bichr. I	Bl. Sl. I	Bl. Sl. I-II	Bl. Sl. II	Pl. Wh. II	Coarse W.	Pike	Knife	Pin	Pin	Fibula	Finger-ring	Bowl	Pin
1. 5	2. 3	14, 18	8. 17	19	7. 10	4. 12	28. 31	32 a, b, c	27	25	34	22 a	23 a	21	26
9. 13	6. 11											22 b			
15. 16	29. 33											23 b			
20. 30												24			
-8	-6	-2	-2	-1	-2	-2	-2	-3	-1	-1	-1	-4	-1	-1	-1

CHRONOLOGY

The pottery found in the tomb consists of the following wares: White Painted I—II, Bichrome I, Black Slip I—II, and Plain White II. Types I and II are about equally represented with a slight preponderance of Type I assigning the tomb to the middle of Cypro-Geometric II.

TOMB 412 (Fig. 77: 1—5)

	SIZE			
	Length	Width	Depth	Height
Dromos	6.10	0.95	1.90	—
	(original dromos)			
Stomion	0.23	0.33	—	0.80
Chamber	2.28	1.78	—	c. 0.90

SHAPE

The dromos is a long, narrow passage with walls tapering upwards very slightly: the floor descending gradually towards the door. The beginning of the dromos is irregularly shaped: it runs first for about 2.40 m. in a north-western direction; there its west wall is hollowed out, and it makes a sharp turn running north-northwest for the rest of its course. This must be connected with the finding of three burials in the hollowed out part of the dromos (see below) and seems to be explained by the original entrance of the dromos having been at the point where it turns in north-northwesterly direction: this entrance was later hollowed out and widened for the burials and a new, short dromos made leading in to the buried bodies. The door has straight sides and flat roof and was closed by a packing of rough stones. The stomion is rather short and rectangular in plan. It opens on to the chamber to the left of its longitudinal axis and its floor descends to that of the chamber by a sloping step. The chamber is trapezoid in plan, with the side walls widening towards the back wall, and rounded corners. The floor is approximately horizontal. The roof slopes towards the back wall, but has collapsed. Its original level was indicated by a few preserved pieces near the walls. The left wall has entirely collapsed so that this chamber and Tomb 407 now communicate (cf. above p. 201).

STRATIFICATION

The filling of the dromos consisted of intact layers of homogeneous *chavara*.

In the chamber there was a burial and culture stratum on the bottom, covered by a thick, compact layer of rock material from the collapsed roof. All the objects were found on the floor.

BURIALS

In the chamber no skeletal remains were preserved. In the dromos, on the other hand, remains of three bodies were found. They had been buried in the hollowed out part at the

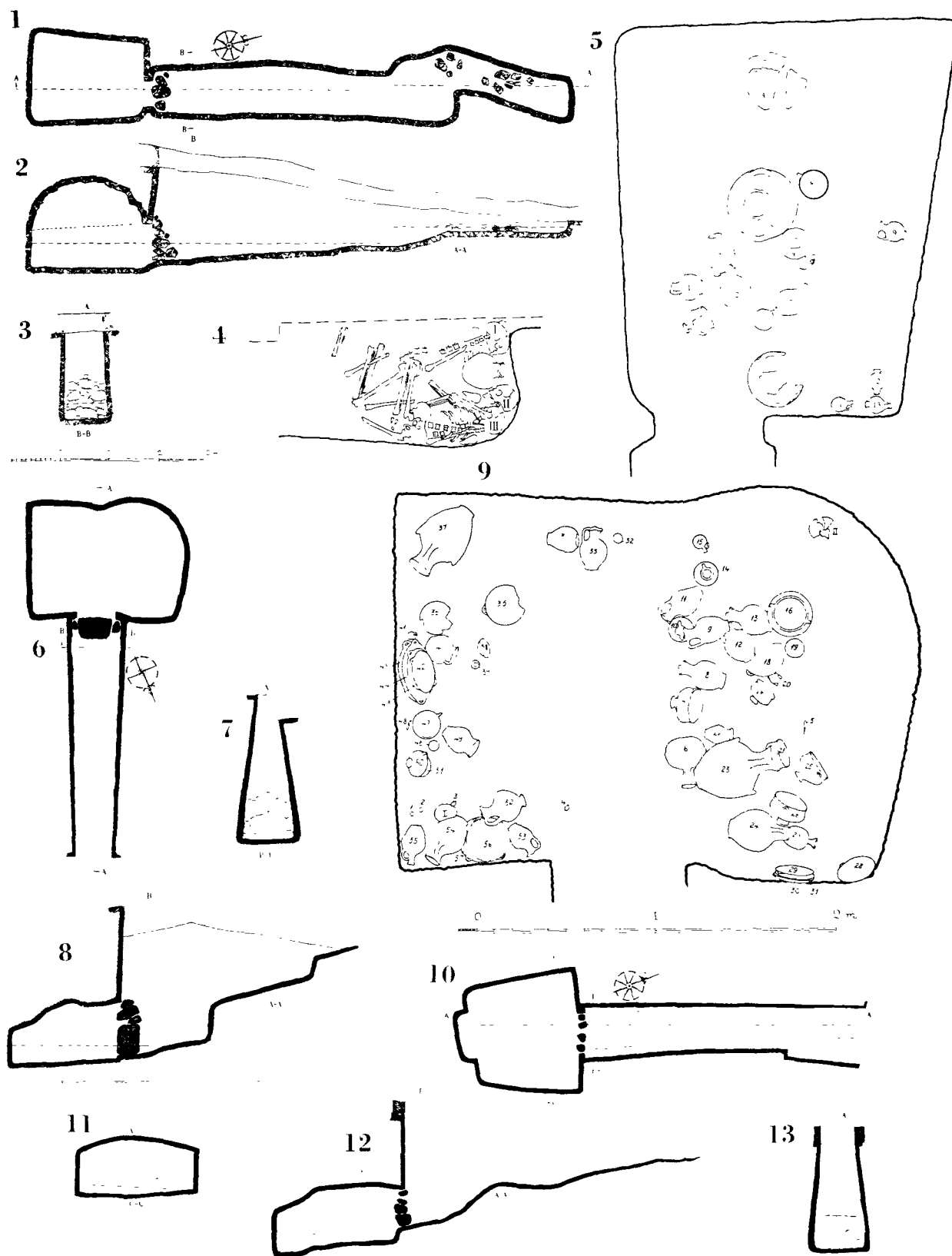

Fig. 77. Lapithos. Tomb 412, Plan (1); Sections A-A, B-B (2, 3); Skeletons in dromos (4); Finds *in situ* (5)
 Tomb 413, Plan (6); Sections B-B, A-A (7, 8); Finds *in situ* (9). Tomb 414, Plan (10);
 Sections C-C, A-A, B-B (11—13).

entrance of the original dromos and were well preserved. Skeleton No. I was placed on its left side in a contracted position with the head towards the North, resting on a stone. Skeleton No. II was placed opposite that of No. I on its right side in the same contracted position, and Skeleton No. III was found lying face downwards above that of No. II. Between the skulls of Skeletons Nos. I and II a single jug was placed. Probably it is a burial of slaves killed at the funeral of the deceased buried in the chamber.

FINDS (GROUP: PL. XLVIII, 3; TYPE: L. OF PL. II)

1. Black Slip I oval jug with base-ring; concave neck; pinched mouth; handle from neck to shoulder. Fluted body and three horizontal, grooved lines round shoulder. Part of neck and mouth missing. Height 16.5. Floor.
2. White Painted I oval jug with base-ring; concave neck; handle from rim to shoulder. Encircling bands and lines round rim, neck, belly, and base; groups of short lines pendant from base of neck; a framed wavy line along handle. Mouth missing. Height 26.5. Floor.
3. Coarse pyriform jug with flat base; wide, short, concave neck; handle from rim to shoulder. Height 19.6. Floor.
4. Black Slip I jug with low foot and rather pyriform body. Neck missing. Fluted body; no horizontal, grooved lines. Height 19.0. Floor.
5. White Painted I open bowl with low foot; softly curved outline; handle from rim to body. Encircling bands round rim, body, and base. Diam. 11.4. Floor.
6. White Painted I bowl, as No. 5, but with two horizontal handles. One handle and part of bowl missing. Diam. 14.6. Floor.
7. Plain White I double-conical jug with base-ring; concave neck; annular rim; handle from neck to shoulder. Height 21.8. Floor.
8. White Painted II open bowl with base-ring; angular outline; vertical sides; handle from rim to body. Decoration as No. 5. Diam. 16.8. Floor.
9. White Painted I oval jug with base-ring; very short neck; pinched mouth; handle from rim to shoulder. Encircling lines and bands round rim, neck, belly, and base; lattice triangles on shoulder. Height 14.6. Floor.
10. White Painted I spherical jug with narrow neck; collar-shaped mouth; handle from neck to shoulder. Encircling lines round rim and neck; encircled spirals on body; ladder-pattern on handle. Height 11.5. Floor.
11. White Painted I jug, as No. 10. Height 12.4. Floor.
12. Plain White I—II oval jug with low foot; concave neck; annular rim; handle from neck to shoulder. Height 13.8. Floor.
13. Plain White I—II jug, as No. 12. Height 14.4. Floor.
14. White Painted I oval amphora with base-ring; short, concave neck; splaying, swollen rim. Encircling lines and bands round neck, shoulder, belly, and base; lattice triangles on shoulder. Height 39.7. Floor.
15. White Painted I ovoid amphora with base-ring; concave neck; much splaying rim; two horizontal handles on shoulder. Encircling lines and bands round rim, neck, shoulder, belly, and base; three wavy lines round belly, a frieze of lattice lozenges on shoulder and lattice triangles below neck. Rim partly missing. Height 52.3. Floor.
16. White Painted I amphora, as No. 14. Height 43.6. Floor.

Summing up the classification given in the Object Register, we obtain the following diagram:

P o t t e r y						
Wh. P. I	Wh. P. II	Bl. Sl. I	Pl. Wh. I	Pl. Wh. I-II	Coarse W.	
2. 5. 6	8	1. 4	7	12. 13	3	
9. 10. 11						
14. 15. 16						
-9	-1	-2	-1	-2	-1	

CHRONOLOGY

The tomb contains twelve specimens of Type I: White Painted I, Black Slip I and Plain White I; two specimens of Plain White I—II, and one specimen of White Painted II, which imply a date at the end of Cypro-Geometric I.



Fig. 78. Lapithos. Tomb 413, dromos.



Fig. 79. Lapithos. Tomb 413. Interior view of chamber with finds being removed.

TOMB 413 (Figs. 77: 6—9; 78; 79)

	SIZE			
	Length	Width	Depth	Height
Dromos	4.50	0.97	2.90	
Stomion	0.16	0.75	—	1.00
Chamber	2.20	2.95	—	c. 0.95

SHAPE

The dromos is a medium-sized, narrow passage, widening towards the door near the bottom, and with slightly curved side walls, which narrow upwards, especially near the back part. It descends by three wide, sloping steps to the door. The door is roughly rectangular with rounded corners and was closed by a door-packing consisting of a large stone surrounded by rubble. The stomion is very short and rectangular in plan. It opens on to the chamber somewhat to the left of the longitudinal axis of the same. The floor of the dromos descends to that of the chamber by a vertical step. The chamber is irregular in shape, with the right wall and the right end of the back wall curved, and the other walls straight. The floor and the roofs slope towards the back wall; part of the roof has fallen in.

STRATIFICATION

The filling of the dromos consisted of intact layers of *chavara*. In the chamber there was a burial and culture stratum on the floor, covered by a layer of broken rock from the fallen in roof, in the middle of the chamber, but for the remainder, the burial stratum together with the tomb-gifts was free and uncovered.

BURIALS

Two bodies had been buried in the chamber. Of the skeleton of the first, the skull was found intact near the left wall of the chamber. Of the second body only fragments of the skull were preserved, near the right end of the back wall. In connection with the first skeleton spindle-whirls of stone were found indicating that the body was a female. The dress of the second body had been fastened by a bronze pin (No. 5). The tomb-gifts in pots of terracotta and two bronze bowls (Nos. 19, 38), were placed beside the two bodies in the left and right sides of the chamber.

FINDS (GROUPS: PL. XLIX, I—3; TYPES: L. OF PL. II)

1. Cylindrical button of bone with an incised line round the periphery, and with a hole pierced in the centre. Diam. 2.5. Floor.
2. Biconical spindle-whirl of light-blue steatite, with a hole pierced in the centre. Length 2.4. Floor.
3. Spindle-whirl of terracotta with flat base and top; concave sides; with a hole pierced in the centre. Diam. 2.4. Floor.
4. Spindle-whirl, shape as No. 2, of brownish-black steatite, with a hole pierced in the centre. Incised decoration of encircled dots. Length 2.0. Floor.
5. Straight, thin bronze pin with pointed end. Upper part missing; broken into two pieces. Length 8.7. Floor.
6. Bichrome II barrel-shaped jug with round base; narrow neck with handle-ridge; funnel-shaped mouth; handle from neck to shoulder. Encircling lines and bands round neck; transverse lines on rim; concentric circles on both sides of body; framed crossed lines below handle; a band of latticed, winged lozenges in front. Height 28.1. Floor.
7. White Painted I open bowl with low foot; softly curved outline; two horizontal handles. Encircling bands round rim, body, and base outside and inside. Diam. 19.7. Floor.
8. Black Slip I oval jug with base-ring; concave, rather wide neck; pinched mouth; handle from rim to shoulder. Fluted body, and three horizontal, grooved lines round shoulder. Height 23.2. Floor.
9. Black Slip I jug, as No. 8. Height 24.1. Floor.
10. Black Slip II jug, similar to No. 8, but with slimmer body, and three to four horizontal, grooved lines round shoulder. Height 22.6. Floor.
11. Black Slip I jug, as No. 8, but with depressed ovoid body, and narrower neck. Height 23.6. Floor.
12. Bichrome II oval jug with base-ring; slightly concave neck; pinched mouth; handle from rim to shoulder. Encircling lines and bands round rim, neck, shoulder, belly, and base; lattice triangles on shoulder; ladder-pattern on handle. Height 22.4. Floor.
13. Black Slip I jug, as No. 11. Height 22.4. Floor.
14. Coarse oval jug with raised, flat base; wide neck, widening upwards; handle from rim to shoulder. Height 14.8. Floor.
15. White Painted II barrel-shaped jug with round base; narrow neck with handle-ridge; funnel-shaped mouth; handle from neck to shoulder. Encircling lines and bands round neck and five groups of concentric circles on body. Height 10.5. Floor.
16. Coarse shallow, open bowl with round base; raised rim, and two handles from rim to body. Diam. 20.0. Floor.
17. White Painted I open bowl with low foot; softly curved outline; a vertical handle from rim to body. Encircling band inside and round foot; two sweeping lines round body. Diam. 14.8. Floor.
18. White Painted I—II plate with flat base, and two horizontal handles. Encircling lines, bands, and concentric circles inside; four framed lattice triangles meeting in concentric circles on base; encircling bands and lines round base. Diam. 23.4. Floor.
19. Hemispherical bronze bowl with round base. Diam. 10.4. Floor.
20. Red Slip amphoriskos with depressed pyriform body; short, stemmed foot; wide, cylindrical neck; flat rim, slightly down-turned; two handles from rim to shoulder. Probably foreign ware. Height 6.9. Floor.
21. White Painted I bowl, as No. 17. Diam. 16.1. Floor.
22. Coarse oval jug, as No. 14. Height 14.6. Floor.
23. White Painted I oval hydria with base-ring; concave neck; swollen splaying, rim. Encircling lines and bands round rim, neck, shoulder, belly, and base; groups of short pendant lines from base of neck, two hooked lines below; a framed zigzag line along handle. Height 45.2. Floor.
24. Plain White II ovoid jug with base-ring; neck tapering slightly upwards, annular rim; handle from neck to shoulder. Height 32.6. Floor.
25. White Painted I bowl, as No. 7. Diam. 18.0. Floor.
26. White Painted I bowl, as No. 7. Diam. 19.5. Floor.
27. White Painted I—II jug, shape as No. 15, but with shorter neck, and concave, collar-shaped mouth. Encircling lines and bands on body and ladder-pattern on handle. Height 19.5. Floor.
28. White Painted I plate, shape as No. 18. Encircled wheel inside; framed band of lattice lozenges flanked by lattice triangles on base; encircling lines and bands round base. Diam. 22.6. Floor.

- 29. White Painted I plate, as No. 28, but with concentric circles inside. Diam. 22.0. In No. 30.
- 30. White Painted I plate, shape as No. 18. Encircled wheel inside; four lattice triangles meeting in small concentric circles on base; encircling lines and bands round base. Diam. 22.6. In No. 31.
- 31. White Painted I—II plate, as No. 18, decoration as No. 30, but with an encircled wheel on base. Diam. 23.5. Floor.
- 32. White Painted I squat miniature jug with round base; short, narrow neck; splaying rim; handle from neck to shoulder. Encircling lines round rim, neck, and belly; a spiral on base; ladder-pattern on handle. Height 22.6. Floor.
- 33. Black Slip I oval jug, as No. 11. Height 22.6. Floor.
- 34. Black Slip II oval jug, as No. 10. Neck missing. Height 15.2. Floor.
- 35. White Painted I plate, shape as No. 18, but with raised, flat base. Encircling lines and a latticed square flanked by four lattice triangles on base. Decoration faded. Diam. 23.0. Floor.
- 36. White Painted I bowl, as No. 25. Diam. 17.2. Floor.
- 37. White Painted I hydria, as No. 23. Height 41.5. Floor.
- 38. Bronze bowl, as No. 19. Diam. 10.6. Floor.
- 39. White Painted I miniature jug, as No. 32, but with concentric circles on base. Height 4.6. Floor.
- 40. Coarse oval jug, as No. 14, but with shorter, wider neck, widening upwards. Height 16.5. Floor.
- 41. Coarse oval jug, as No. 14. Height 5.7. Floor.
- 42. White Painted I plate, as No. 30, but with an encircled spiral inside the bottom. Diam. 24.3. In No. 43.
- 43. White Painted I plate, as No. 30, but with four lattice triangles meeting in a circle on base. Decoration faded inside. Diam. 23.2. In No. 44.
- 44. White Painted I—II plate, as No. 18. Diam. 34.4. In No. 45.
- 45. White Painted I—II plate, as No. 18. Diam. 33.5. Floor.
- 46. White Painted I barrel-shaped jug, as No. 15. Neck and handle missing. Height 6.1. Floor.
- 47. White Painted I bowl, as No. 17. Diam. 14.4. Floor.
- 48. Thin, straight bronze pin with pointed end. Upper part missing. Length 5.2. Floor.
- 49. Coarse oval jug, as No. 40, but with slimmer body and taller neck. Height 19.0. Floor.
- 50. White Painted I bowl, as No. 17, but without sweeping lines. Diam. 14.5. Floor.
- 51. White Painted I bowl, as No. 17. Diam. 14.1. Floor.
- 52. White Painted I depressed pyriform jug with low foot; concave neck, tapering upwards; pinched mouth; handle from rim to shoulder. Encircling lines and bands round rim, neck, shoulder, belly, and base; two wavy lines on neck and a wavy line along handle. Height 25.8. Floor.
- 53. Black Slip I jug, as No. 8. Height 19.3. Floor.
- 54. Black Slip I oval amphora with base-ring; concave, narrow neck; splaying, ridged rim; two handles from neck to shoulder. Fluted body; three horizontal, grooved lines round shoulder. Height 25.8. Floor.
- 55. Plain White I oval, slm jug with flat base; narrow neck, tapering slightly upwards; annular rim; handle from rim to shoulder. Height 22.7. Floor.
- 56. White Painted I plate, as No. 42. Diam. 23.7. Floor.
- 57. White Painted I plate, as No. 35. Decoration nearly effaced. Diam. 25.2. Floor.

Summing up the classification given in the Object Register, we obtain the following diagram:

P o t t e r y													B r o n z e		Terra-cotta	Stone	Bone
Wh. P. I	Wh. P. I-II	Wh. P. II	Bichr. II	Bl. Sl. I	Bl. Sl. II	Pl. Wh. I	Pl. Wh. II	Coarse W.	R. Sl. (foreign.)	Pin	Bowl	Spindle-whirl	Spindle-whirl	Button			
7. 17 21. 23. 25. 26	18. 27	15	6. 12	8. 9	10 34	55	24	14. 16	20	5. 48	19. 38	3	2. 4	1			
28. 29. 30. 32. 35. 36	31. 44			11. 13				22. 40									
37. 39. 42. 43. 46. 47	45			33 53				41. 49									
50. 51. 52. 56. 57				54													
-23	-5	-1	-2	-7	-2	-1	-1	-6	-1	-2	-2	-1	-2	-1			

CHRONOLOGY

Nearly all the pottery is of Type I: White Painted I, Black Slip I, and Plain White I; some specimens are transitional between Types I and II (Nos. 18, 27, 31, 44, 45) and a few are early Type II: White Painted II, Bichrome II, Black Slip II, and Plain White II. This combination of types assigns the tomb to the early part of Cypro-Geometric II. The single specimen of foreign Red Slip Ware (No. 20) is noteworthy.

TOMB 414 (Fig. 77: 10—13)

	SIZE			
	Length	Width	Depth	Height
Dromos	5.70	1.00	2.20	—
Stomion	0.23	0.80	—	0.80
Chamber	2.43	2.38	—	1.10

SHAPE

The dromos is a rather long, narrow passage, widening at the bottom, towards the door. The side walls narrow upwards, especially near the back part of the dromos. Its floor slopes gradually to about 4 m. from the entrance. The doorway, roughly rectangular in shape, was closed by a packing of rough stones, which was rather loosely built up and not intact. The stomion is very short and rectangular in plan. It opens on to the chamber in its longitudinal axis. The floor of the dromos descends to that of the chamber by a vertical step. The chamber is trapezoid in plan with the side walls narrowing towards the back wall, and with rounded back corners. In the back wall opposite the entrance, there is a loaf-shaped, shallow niche cut in the rock on a level with the floor of the chamber. The floor and roof of the chamber slope towards the back and the right side walls, the latter forming a flat vault.

STRATIFICATION

The filling of the dromos consisted of intact layers of *chavara*, interrupted near the door by a shaft dug down and refilled again, which, together with the disturbed door-packing, indicated that the tomb had been robbed. This was confirmed by the circumstances of finds and the stratification, in the tomb-chamber itself. This was found half filled with a mixed layer of scattered burial remains, earth, and *chavara* brought in from the dromos-filling, and was entirely disturbed by the tomb-robbers, and contained nothing but a few broken pottery fragments.

BURIALS

As stated above only scattered and disturbed burial remains were found.

FINDS

All the potsherds found in the disturbed layers of the tomb are of Type I: White Painted I, Black Slip I, Black Slip Painted I, and Plain White I.

CHRONOLOGY

This combination of pottery types assigns the tomb to Cypro-Geometric I.

TOMB 415 (Fig. 80: 1-3)

SIZE

	Length	Width	Depth	Height
Dromos	4.10	1.08	2.25	—
Stomion	0.17	0.90	—	c. 0.90
Chamber	2.13	2.35	—	1.00

SHAPE

The dromos is of the medium-sized passage type, but wider than usual, the side walls closing in at the top. The floor descends by a step to the entrance of the dromos and then, slopes gradually down to the door. In the middle, there is a shallow cavity. The door has straight sides and an irregularly shaped roof and was closed by a packing of stones roughly built, and not intact. The stomion is very short, and approximately rectangular in plan; part of its roof has collapsed. It opens on to the chamber approximately in its longitudinal axis. The chamber is roughly trapezoid, with the side walls narrowing towards the oblique and slightly curved back wall, and rounded corners. The floor and the roof of the chamber are approximately horizontal. The upper part of the right side wall separating this chamber from that of Tomb 410 has collapsed, so that the two chambers communicate (cf. above p. 212).

STRATIFICATION

The filling of the dromos consisted of a hard-packed layer of white *chavara*, mixed with potsherds in the cavity and at the bottom in front of the door; and an upper layer of the usual *chavara*. Above the door this filling was interrupted by a wedge-shaped layer of clayey earth mixed with stones, forming a refilled shaft dug down to the door, and, together with the disturbed door-packing, indicating that the tomb had been visited by tomb-robbers. This was verified by the stratification and the circumstances of finds in the tomb-chamber itself. This did not contain anything but a few potsherds, and a fragment of an idol, scattered about in the loose filling of burial remains, and earth and *chavara* brought in from the dromos, by the rains.

BURIALS

As stated above the burial remains were destroyed by the tomb-robbers.

FINDS (PL. XLIX, 4)

- | | |
|--|--|
| 1. Terracotta figure of "snow-man" technique with an oval face; pointed beard; incised mouth; nose, eyes, and ears added in pellets of clay. Lower part of body, part of left arm, and right arm missing. Angular line painted below neck in front. Length 6.5. In the filling | Besides this figure, numerous potsherds of Types I—II were found in the disturbed layers of the chamber: White Painted I—II, Bichrome II, and Black Slip I—II. |
|--|--|

CHRONOLOGY

This combination of pottery types assigns the tomb to Cypro-Geometric II.

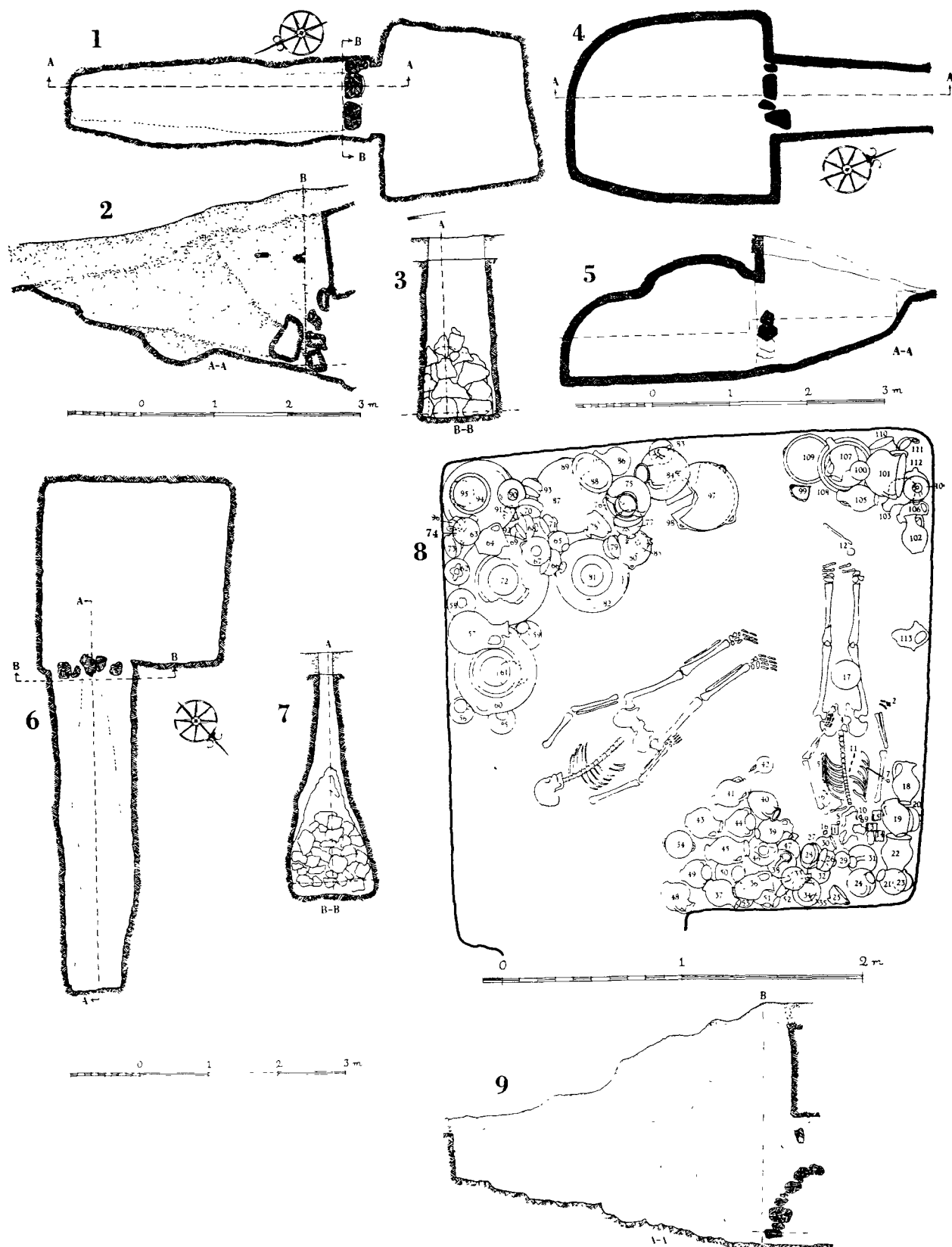

Fig. 80. Lapithos. Tomb 415, Plan (1); Sections A-A, B-B (2, 3). Tomb 416, Plan (4); Section A-A (5). Tomb 417, Plan (6); Sections B-B, A-A (7, 9); Finds *in situ* (8).

TOMB 416 (Fig. 80: 4—5)

	SIZE			
	Length	Width	Depth	Height
Dromos	2.00	0.90	1.43	—
	(fore-part missing)			
Stomion	0.12	0.90	—	1.07
Chamber	2.50	2.25	—	c. 1.10

SHAPE

The dromos is a short, narrow shaft, widening towards the door. The fore-part is cut through from below by the collapse of the roof of Tomb 417. It descends by a rather steep slope to the door. The door occupies the whole width of the dromos, and is trapezoidal in shape with rounded corners; it was closed by a packing of rough stones, loosely built and not intact. It opens on to the chamber slightly to the right of its longitudinal axis and the floor of the dromos slopes gradually down to that of the chamber. The chamber has the same shape as that of Tomb 406. The floor and roof slope towards the back wall. Part of the roof has collapsed.

STRATIFICATION

The filling of the dromos consisted of the usual *chavara*, above the door interrupted by a wedge-shaped layer of the same kind as in Tomb 415, indicating that the tomb had been visited by tomb-robbers. This was verified by the circumstances of the finds and the stratification in the tomb-chamber itself, where only fragments of pottery left by the tomb-robbers were found, scattered about in the loose filling brought in from the dromos and mixed up with broken rock from the collapsed part of the roof.

BURIALS

There were no burial remains left.

FINDS

The pottery fragments, mentioned above, consist of Types I—II: White Painted I—II, Bichrome II, Black Slip II, Grey Polished, and Plain White I—II. Types II are in majority.

CHRONOLOGY

This combination of pottery types assigns the tomb to the end of Cypro-Geometric II.



Fig. 81. Lapithos. Tomb 417, dromos.



Fig. 82. Lapithos. Tomb 420, dromos.

TOMB 417 (Figs. 80: 6—9; 81; 83; 84—86)

	SIZE			
	Length	Width	Depth	Height
Dromos	c. 4.60	1.15	3.23	—
Stomion	—	1.15	—	c. 1.20
Chamber	2.70	2.70	—	c. 1.20

SHAPE

The dromos is of the usual passage type but unusually deep and much widened at the bottom towards the door. The side walls narrow quickly upwards, especially near the back of the dromos above the door, where they almost converge so that the dromos in the upper plan has the shape of a wedge. At the entrance it is cut vertically, then slopes gradually towards the door. A part of the rock wall above the door has collapsed. The door occupies the whole width of the dromos; its upper part is destroyed, but seems to have been vaulted. It was closed by the usual packing of rough stones. It opens on to the chamber near the left end of its front wall. The floor of the dromos is on a level with that of the chamber. The chamber is nearly square in plan with rounded corners. The floor is approximately horizontal. The roof has entirely collapsed, so that its shape is uncertain.



Fig. 83. Lapithos. Tomb 417. Door-packing.



Fig. 84. Lapithos. Tomb 417. North corner of chamber with finds *in situ*.

STRATIFICATION

The dromos-filling consisted of intact, homogeneous *chavara*. In the chamber, there was a single burial and culture stratum on the floor and an upper covering filling of rock from the collapsed roof. The rock crumbled slowly at the beginning so that the lower part of the filling covering the finds consisted of pulverized rock, which had not damaged the finds. The objects were found on the floor, but some were piled on the top of others at the time of the later burial (see below), in order to make room for the new body then buried.

BURIALS

Two burials have taken place in the chamber. The skeletons of both the bodies were well preserved. The skeleton of the first corpse was found along the right wall in an outstretched, dorsal position, with the head towards the front wall. It was a female skeleton and the body had been richly adorned with gold ornaments and other personal effects. Between the femora was a bronze bowl (No. 17). Both hands had finger-rings of gold (Nos. 2, 3), both on the middle finger. This hand was also holding an ivory comb (No. 4). Earrings of gold (Nos. 8, 9, 10, 16) once adorned the ears, and round the skull were found four plaques of gold with embossed figure representations (Nos. 1, 13, 14, 15), used to ornament the head-gear like that of Skeleton No. VI in Tomb 403. One pin of bronze with an amber head (No. 7) was found on the right shoulder, and another, with a golden head (No. 5) in shape of a pomegranate, along the left side of the skeleton; both used to fasten the dress. The skeleton of the second body was found on the north-east and south-west



Fig. 85. Lapithos. Tomb 417. South corner of chamber with finds *in situ*.



Fig. 86. Lapithos. Tomb 417. Skeleton I.

diagonal of the chamber with the head towards the door. It was also placed in an outstretched, dorsal position and rested on a bed of compactly pressed lime-earth mixed with clay, about 0.07 m. thick. The body was male. Probably the iron pike (No. 12) belonged to this skeleton and the fibula of bronze (No. 29) may have been used to fasten its dress, though they were not found in direct connection with the skeleton, but moved to the right back corner of the chamber. The tomb-gifts, in pots, were mainly accumulated in the right front corner and the left back corner, and besides these, there was a smaller accumulation in the right back corner. At the time of the second burial some of the earlier vases were placed on the top of each other in order to make room for the new body.

At the door remains of a third skeleton were found. The skull was found outside the door in the dromos itself, and fragments of the bones were found below the stones of the door-packing. The body was therefore buried there when the door was closed, and probably represents a slave burial, the door-keeper of the deceased who was killed at the funeral in order to watch the door of the tomb, and serve them in the life to come, as he had done previously.

FINDS (GROUPS: PL. L, LI; TYPES: L. OF PL. II)

1. Rectangular gold plaque with short sides rolled-up and long sides folded, holes pierced in the corners for fastening the plaque to a head-gear of cloth. The plaque is decorated with an embossed representation of a female, naked figure standing on a rosette; short body, legs seen in profile; body frontal; arms lifted up in pose of adoration; large, triangular head; open mouth with pendant tongue, large ears; thick nose; elliptical eyes; nearly straight eyebrows, large, cylindrical head-gear, ornamented with horizontal ridges. Length 6.0. Floor.
2. Finger-ring of thin gold with furrowed lines. Diam. 2.0. On the middle finger of r. hand of Skeleton I.
3. Finger-ring of gold, as No. 2. Diam. 2.0. On the middle finger of l. hand of Skeleton I.
4. Ivory comb with double-sided teeth; ornamented with a band of guilloche framed by bands of parallel lines. Only one end of the comb preserved. Length 9.5. Floor.
5. Straight bronze pin with pointed end and hammered, square top; gold head in shape of a pomegranate. Length 15.6. Floor.
6. Straight pin of bone, decorated with incised lines round upper end. Pointed end missing. Broken. Length 7.8. Floor.
7. Straight bronze pin with pointed end and oval head of amber. Length 14.8. On the skeleton.
8. Circular gold earring with overlapping ends, slightly swollen below. Diam 3.2. Floor.
9. Gold earring, as No. 8. Diam. 3.1. Floor.
10. Boat-shaped gold earring with overlapping ends, and a cluster of small balls added below. Diam. 2.1. Floor.
11. Thin, straight bronze pin. Not complete. Length 6.6. Floor.
12. a) Straight iron pike, narrowing towards the point. Length 29.5.
b) Circular button of bone with one side flat, the other slightly convex; a hole pierced in the centre. The

- convex side is decorated with an incised rosette, encircled by incised lines. Diam. 3.3. Floor.
13. Gold plaque, as No. 1. Length 5.7. Floor.
 14. Gold plaque, as No. 1. Length 5.7. Floor.
 15. Gold plaque, as No. 1. Length 5.6. Floor.
 16. Gold earring, as No. 10. Diam. 2.2. Floor.
 17. Hemispherical bronze bowl with round bottom and flat rim. Diam. 16.5. Between the femora of Skeleton I.
 18. Plain White I oval jug with base-ring; concave neck; pinched mouth; handle from rim to shoulder. Height 22.0. Floor.
 19. Coarse ovoid jug with flat base; wide, slightly concave, short neck; handle from rim to shoulder. Height 19.5. Floor.
 20. White Painted I open bowl with low foot; softly curved outline; vertical handle from rim. Two sweeping lines round body. Diam. 13.6. Floor.
 21. Plain White I jug with base-ring; neck slightly tapering upwards; annular rim; handle from neck to shoulder. Height 22.0. Floor.
 22. White Painted I amphoriskos with low foot; short, wide, concave neck; horizontal handles on shoulder. Encircling bands and metope decoration of vertical, latticed bands on neck. Height 18.3. Floor.
 23. White Painted I open bowl with low foot; softly curved outline; two horizontal handles. Encircling bands. Diam. 9.8. Floor.
 24. Plain White I jug, as No. 21. Height 22.6. Floor.
 25. White Painted I bowl, as No. 20, but without sweeping lines; encircling band. Diam. 13.0. Floor.
 26. White Painted I bowl, as No. 20. Diam. 13.0. On Nos. 27, 29, 32.
 27. White Painted I bowl, as No. 20, but with spiral inside the bottom. Diam. 14.0. Floor.
 28. White Painted I bowl, as No. 23. Diam. 10.3. In No. 27.
 29. Black Slip I globular jug with base-ring; concave neck; pinched mouth; handle from rim to shoulder. Fluted body, and three to four horizontal, grooved lines round shoulder. Height 12.2. Floor.
 30. Coarse oval jug, as No. 19. Height 10.5. Floor.
 31. Black Slip I depressed pyriform jug with low foot, concave neck; pinched mouth; ridged handle from rim to shoulder. Fluted body. Height 20.0. Floor.
 32. White Painted I depressed jug with short, narrow, concave neck; collar-shaped mouth; handle from neck to shoulder. Encircling lines and bands on body. Height 19.3. Floor.
 33. White Painted I depressed spherical jug with neck, mouth, and handle as No. 32. Five groups of concentric circles on body. Height 16.5. On Nos. 34, 38.
 34. Coarse jug, as No. 30. Height 15.3. Floor.
 35. White Painted I squat, miniature jug. Encircling lines and a maltese cross on base. Neck and handle missing. Diam. 5.5. Inside No. 34.
 36. Black Slip I oval jug with base-ring; concave neck; pinched mouth; handle from rim to shoulder. Fluted body. Height 20.3. On Nos. 51, 52, 53.
 37. Plain White I jug, as No. 21. Height 20.5. On Nos. 50, 53.
 38. Plain White I oval jug, as No. 21. Height 23.2. Floor.
 39. White Painted I oval jug with base-ring; short, concave neck; pinched mouth; handle from rim to shoulder. Encircling lines and bands round belly, shoulder, and neck; groups of vertical, short lines pendant from base of neck; two wavy lines round neck; zigzag line on handle. Height 22.7. Floor.
 40. Plain White I jug, as No. 21. Height 24.8. Floor.
 41. Black Slip I oval amphora with low foot; wide, slightly concave neck; annular rim; handles from neck to shoulder. Fluted body. Height 20.2. Floor.
 42. White Painted I pilgrim-bottle with a handle from neck to shoulder. Encircling lines and bands; vertical band of herring-bone pattern round the body; ladder-pattern on handle. Height 15.3. Floor.
 43. Plain White I depressed oval jug, as No. 21. Height 21.0. Floor.
 44. Black Slip I oval amphora, as No. 41. Height 22.7. Floor.
 45. Plain White I oval jug with base-ring; concave neck; splaying, annular rim; handle from neck to shoulder. Height 25.2. Floor.
 46. White Painted I oval jug, shape similar to No. 39, but with wider, concave neck. Encircling lines round belly and shoulder; wavy lines on neck; lattice triangles on shoulder. Height 21.5. Floor.
 47. White Painted I spherical jug with narrow, cylindrical neck; splaying rim; handle from neck to shoulder. Encircling lines round rim and base of neck; a framed zigzag band round body, ladder-pattern on handle. Height 19.5. Floor.
 48. White Painted I jug, as No. 39, but without vertical lines pendant from base of neck, and with three wavy lines on neck. Height 22.5. Floor.
 49. Black Slip I amphora, as No. 41. Height 22.7. Floor.
 50. Black Slip I depressed pyriform jug with low foot; concave neck; annular rim; handle from neck to shoulder. Height 22.1. Floor.
 51. Black Slip I amphora, as No. 41. Height 21.5. Floor.
 52. Coarse oval amphora with flat base; short, wide neck; handles from rim to shoulder. Height 18.0. Floor.
 53. Bichrome I pilgrim-bottle with two handles from neck to shoulder. Concentric circles on body. Height 16.3. Floor.
 54. White Painted I bowl, shape as No. 23. Encircling bands; metope decoration of a lozenge, filled with lattice chequers and flanked by vertical bands of lattice lozenges framed by parallel lines. Diam. 15.2. Floor.
 55. Plain White I jug, as No. 21. Height 19.7. Floor.
 56. Plain White I jug, as No. 21. Height 21.3. Floor.
 57. White Painted I depressed spherical jug, shape as No. 33, and decoration as No. 32. Height 34.8. On Nos. 60, 72.
 58. White Painted I oval jug. Encircling lines and bands. Neck and handle missing. Height 16.0. On No. 72.

59. Plain White I jug, as No. 21. Height 23.0. Floor.
60. White Painted I depressed pyriform amphora with base-ring; concave neck; splaying rim; two horizontal handles on body and two small, vertical handles on shoulder. Encircling lines and bands round shoulder, belly, and base; neck covered with black paint and encircling lines between; groups of transverse lines on rim; wavy lines round belly; on shoulder framed triangles filled with chequered lattice lozenges; latticed, vertical bands; bands of lattice lozenges, framed by parallel lines. Height 50.2. Floor.
61. White Painted I spherical jug, as No. 32. Height 19.5. Inside No. 60.
62. Plain White I jug, as No. 18. Height 20.2. On No. 72.
63. White Painted I circular, lentoid jug with short, narrow neck; handle from neck to shoulder. Concentric circles on body and lattice lozenges on shoulder. Height 16.7. On Nos. 74, 94, 96.
64. Coarse oval jug, as No. 19. Height 17.2. On Nos. 72, 94.
65. Red Slip Painted oval jug with base-ring; cylindrical neck; pinched mouth; handle from rim to shoulder. Encircling lines round body; three groups of concentric circles on shoulder. Probably foreign ware. Height 15.7. On Nos. 81, 87.
66. White Painted I bowl, shape as No. 23. Encircling bands and metope decoration of latticed bands framed by parallel lines. Diam. 14.1. On Nos. 81, 72.
67. White Painted I bowl, as No. 23. Diam. 16.5. In No. 66 and on No. 72.
68. White Painted I bowl, shape as No. 23. Encircling bands and metope decoration of a lozenge-ornament, filled with four lattice lozenges forming a secondary cross, and flanked by vertical, latticed, framed bands. Diam. 14.0. Floor.
69. White Painted I bowl, as No. 23. Diam. 9.8. Floor.
70. White Painted I bowl, as No. 20. Diam. 14.0. On Nos. 87, 90.
71. White Painted I bowl, as No. 20. Diam. 12.4. On No. 87.
72. White Painted I depressed ovoid amphora with base-ring; concave neck; splaying rim; horizontal handles on shoulders. Encircling bands and lines; wavy lines round body; a double frieze of lattice triangles and lozenges round shoulder. Height 57.4. Floor.
73. White Painted I bowl, as No. 20. Diam. 13.2. Floor.
74. Plain White I open bowl with flat base; splaying sides; profiled rim; high loop-handle at rim. Diam. 9.2. On Nos. 73, 94, 96.
75. Coarse oval amphora, as No. 52, but with taller, cylindrical neck. Height 28.0. On Nos. 77, 84, 85.
76. White Painted I bowl, as No. 23. Diam. 10.7. On Nos. 75, 87.
77. White Painted I bowl, as No. 23. Diam. 15.5. On No. 80.
78. White Painted I bowl, as No. 23. Diam. 18.1. On Nos. 75, 87.
79. White Painted I bowl, as No. 20. Diam. 12.7. On No. 81.
80. White Painted I plate with wide base-ring; straight, splaying sides; notched rim; three horizontal, upright handles. Radiating, filled triangles around sides; wheel-ornament encircled by concentric, hatched bands on base; similar ornament encircled by concentric lines and bands inside the bottom. Diam. 20.0. On No. 85.
81. White Painted I oval amphora with short, concave neck; out-turned, swollen rim; two horizontal handles on shoulder. Encircling lines and bands; wavy lines round body; groups of lattice triangles on shoulder. Height 52.0. Floor.
82. Red Slip Painted small, depressed oval jug with flat base; narrow neck with handle-ridge; handle from neck to shoulder. Encircling lines round neck and body; one group of concentric circles on shoulder. Mouth missing. Foreign ware. Height 7.6. Inside No. 81.
83. Plain White I oval jug, as No. 21. Upper part of neck missing. Height 19.0. Floor.
84. White Painted I oval hydria with base-ring; cylindrical neck; annular rim; two horizontal handles on shoulder and one vertical handle from neck to shoulder. Encircling lines and bands round belly, body, shoulder, and neck. Height 40.5. In No. 97.
85. White Painted I bowl, as No. 23. Diam. 11.0. On No. 80.
86. Polychrome White I spherical jug with narrow, concave neck; handle-ridge; handle from neck to shoulder. Concentric circles on body and a vertical band of lattice lozenges between; painted in black and white on polished slip. Foreign ware. Height 21.3. Floor.
87. White Painted I amphora, as No. 72. Height 50.7. Floor.
88. White Painted I spherical jug, as No. 32. Height 18.5. Floor.
89. White Painted I bowl, as No. 23. Diam. 10.2. Floor.
90. White Painted I bowl, as No. 23. Diam. 16.4. On No. 94.
91. White Painted I bowl, as No. 23. Diam. 10.4. Floor.
92. Roughly circular button of bone with flat base and top, pierced by a hole in the centre. Diam. 2.6. Floor.
93. White Painted I bowl, as No. 20. Diam. 13.2. Floor.
94. White Painted I oval amphora; shape similar to No. 72. Encircling lines and bands round neck and body; a frieze of triangles filled with lattice chequers round shoulder; tree-ornament above handles; groups of transverse lines on rim. Height 50.7. Floor.
95. White Painted I bowl, as No. 20. Diam. 14.4. Floor.
96. White Painted I bowl, as No. 23, but with groups of vertical, oblique lines and one group of latticed bands between the encircling lines. Diam. 9.5. On No. 94.
97. White Painted I plate with flat base and two horizontal handles. Four lattice triangles meeting in concentric circles on base; encircling lines and bands round base; encircled wheel-ornament inside. Diam. 37.5. In No. 98.
98. White Painted I plate, as No. 97, but with four opposite groups of lattice triangles and latticed hour-glass ornament between; encircling lines round base; without wheel-ornament inside. Diam. 37.1. Floor.

99. Bronze fibula with angular, beaded bow; double-coiled spring; broad, flat catch; straight pin; the angular fore-end is square in section. Length 12.4. Floor.
100. White Painted I bowl, as No. 23. Diam. 10.4. On Nos. 101, 107.
101. Plain White I wide amphora with short, stemmed foot; squat, conical body; wide, cylindrical neck; flat rim; handles from rim to shoulder. Height 24.0. On Nos. 103, 110.
102. Plain White I oval jug, as No. 21. Height 22.0. Floor.
103. Plain White I jug, as No. 18. Height 22.0. Floor.
104. White Painted I barrel-shaped jug, as No. 32. Height 18.5. In No. 112.
105. Plain White I oval jug, as No. 21. Height 22.0. Floor.
106. White Painted I oval jug with low foot; depressed oval body; short, concave neck; flaring rim; basket-handle; spout strainer on shoulder. Encircling lines and bands round neck and body; lattice triangles on shoulder; ladder-pattern on handle. Height 18.5. Floor.
107. Plain White I oval jug, as No. 21. Height 22.0. In No. 108.
108. Plain White I amphora, as No. 101. Height 28.0. Floor.
109. White Painted I bowl, as No. 23. Encircling bands, horizontal band of short-rippled wavy lines framed by straight lines around body between handles. Diam. 29.5. Floor.
110. White Painted I bowl as No. 23. Diam. 15.0. Floor.
111. Plain White I shallow bowl with round base; softly curved outline; high loop-handle at rim. Diam. 8.2. Floor.
112. White Painted I bowl, as No. 25. Diam. 14.3. Floor.
113. White Painted I jug, similar to No. 39, but with globular body and taller neck, tapering upwards. Encircling lines; two wavy lines round neck and zigzag line on handle. Height 17.0. Floor.
114. White Painted I amphora, as No. 72. Height 53.4. Put together of fragments from chamber and dromos.
115. White Painted I bowl, shape as No. 23. Encircling lines and bands; framed lozenge-ornament filled with lattice lozenges forming a secondary cross and flanked by vertical bands of hatched, contiguous triangles framed by parallel lines. Diam. 12.6. As No. 114.
116. White Painted I bowl, as No. 109. Diam. 17.0. As No. 114.
117. White Painted I bowl, as No. 23. Inside covered with black paint. Diam. 16.5. As No. 114.
118. White Painted I bowl, as No. 117. Diam. 16.6. As No. 114.
119. White Painted I bowl, as No. 23. Diam. 10.8. As No. 114.
120. White Painted I bowl with low, wide foot; biconical outline; flat rim; two horizontal handles on shoulder. Encircling bands and metope decoration of framed, latticed bands and framed, filled hour-glass ornaments on shoulder; groups of transverse lines on rim. Diam. 25.8. As No. 114.
121. White Painted I bowl, shape as No. 23. Encircling bands; metope decoration of latticed bands framed by parallel lines round body. Diam. 15.0. As No. 114.
122. White Painted I bowl, shape as No. 23. Encircling bands, and metope decoration of framed lattice lozenges and bands round body. Diam. 25.2. As No. 114.
123. White Painted I bowl, as No. 121. Diam. 24.5. As No. 114.
124. White Painted I bowl, shape as No. 23. Encircling bands and metope decoration of framed, latticed bands and bands of framed lozenges flanking a central ornament of crossed lines. Diam. 24.7. As No. 114.
125. White Painted I bowl, as No. 121. Diam. 24.8. As No. 114.
126. White Painted I plate, as No. 97, but with lattice triangles meeting in an encircled wheel on base. Diam. 37.1. As No. 114.
127. White Painted I bowl, as No. 23. Diam. 10.5. As No. 114.
128. White Painted I tripod with ridge below rim. Upper part covered with black paint; above legs a frieze of hatched, contiguous triangles; on two legs borders of similar bands, and a band of lattice lozenges between; on third leg a central, latticed band framed by bands of hatched, contiguous triangles. Height 21.3. As No. 114.
129. White Painted I hydria, as No. 84, but with concave neck and splaying rim. Height 43.0. As No. 114.
130. White Painted I open, shallow bowl with base-ring; convex sides; two horizontal handles. Encircling lines and bands inside the bottom, around rim, and base; transverse lines on rim; wheel-ornament on base; fringed, curved bands below handles. Diam. 16.8. As No. 114.
131. White Painted I bowl, as No. 20. Diam. 13.8. As No. 114.
132. White Painted I bowl, as No. 25. Diam. 13.6. As No. 114.
133. White Painted I bowl, as No. 23. Diam. 11.3. As No. 114.
134. White Painted I bowl, as No. 117. Diam. 14.7. As No. 114.

Summing up the classification given in the Object Register, we obtain the following diagram:

P o t t e r y														I r o n		B r o n z e		G o l d			B o n e			
W h. P. I				Bichr. I	Bl. Sl. I	Pl. W h. I		Coarse W.	R. Sl. P. (foreign)	Polychr. Wh. (foreign)	Pike	Pin	Fibula	Bowl	Earring	Finger-ring	Plaque	Pin	Comb	Button				
20.	22.	23.	25.	26.	27.	28	53	29	18.	21	19	65	86	12 a	5	99	17	8	2.	3	1	6	4	12 b
32.	33.	35.	39.	42.	46.	47		31	24.	37	30	82			7			9			13			92
48.	54.	57.	58.	60.	61.	63		36	38.	40	34			11			10				14			
66.	67.	68.	69.	70.	71.	72		41	43.	45	52						16				15			
73.	76.	77.	78.	79.	80.	81		44	55.	56	64													
84.	85.	87.	88.	89.	90.	91		49	59.	62	75													
93.	94.	95.	96.	97.	98.	100		50	74.	83														
104.	106.	109.	110.	112.	113.	114		51	101.	102														
115.	116.	117.	118.	119.	120.	121			103.	105														
122.	123.	124.	125.	126.	127.	128			107.	108														
129.	130.	131.	132.	133.	134				111															
			-76					-1	-8	-21	-6	-2	-1	-1	-3	-1	-1	-4	-2	-4	-1	-1	-1	-2

CHRONOLOGY

All the Cypriote pottery found in this tomb is exclusively of early Type I: White Painted I, Bichrome I, Black Slip I, and Plain White I, which shows that the tomb dates from the early part of Cypro-Geometric I. The three specimens of foreign pottery are noteworthy.

TOMB 418 (Fig. 87: 1—3)

SIZE

	Length	Width	Depth	Height
Dromos	4.00	0.76	2.30	—
Stomion	—	0.76	—	0.77
Chamber	1.80	2.08	—	0.86

SHAPE

The dromos is a medium-sized, narrow passage descending to the door by four steps. It widens slightly at the bottom towards the door, and narrows upwards especially near the back part. At the entrance it is enlarged into a roughly square pit. The door is trapezoid and occupies the whole width of the dromos; it was closed by a door-packing of rough stones loosely built up and not intact. The floor of the dromos slopes gradually down to that of the chamber. The door opens on to the chamber near the left end of its front wall. The chamber is roughly square in plan with front corners and left back corner rounded. The floor slopes towards the back door and the roof is approximately horizontal.

STRATIFICATION

The intact dromos-filling of *chavara* was interrupted by a refilled shaft dug down to the door, together with the disturbed door-packing, indicating that the tomb had been visited by tomb-robbers. This was verified by the stratification and the circumstances of finds in the tomb-chamber itself, which only contained some pottery fragments in the loose filling of earth and *chavara*, which covered the floor. Finds of Byzantine sherds in this filling date the robbery.

BURIALS

There were no burial remains left.

FINDS

The majority of the potsherds found in the disturbed layers of the chamber consists of White Painted I Ware. Besides, some specimens of White Painted II and Bichrome II were found.

CHRONOLOGY

This combination of pottery types assigns the tomb to the early part of Cypro-Geometric II.

TOMB 419 (Fig. 87: 4—7)

	SIZE			
	Length	Width	Depth	Height
Dromos	3.60	0.90	1.70	—
Stomion	0.30	0.85		0.87
Chamber	2.30	2.50	—	1.20

SHAPE

The dromos is of the narrow passage type, nearly rectangular in plan, widening slightly at the bottom towards the door. The side walls narrow upwards very slightly especially near the back end of the dromos; the floor descends abruptly at the entrance and then slopes gradually to the door, but the middle part has collapsed into a cavity in the rock. The door is rectangular, but somewhat defaced by the weathering of the rock; it was closed by the usual packing of rough stones, which, however, were not intact. It opens on to the chamber to the right of its longitudinal axis, and the floor of the dromos descends to that of the chamber by a gradual slope. The chamber is trapezoid in shape with the side walls narrowing slightly towards the back wall and with rounded front corners. The floor is approximately horizontal. The roof is flat. In the back part of the chamber there is a roughly circular basin cut in the floor, 0.20 m. deep.

STRATIFICATION

The stratification of the dromos and the chamber were similar to that of the previous tomb, with a refilled shaft dug through the filling in front of the door, indicating that the

chamber had been visited by tomb-robbers, and a loose filling of broken rock and infiltrated earth and *chavara* containing only pottery fragments in the chamber. After the robbery the thieves threw the stones of the door-packing into the bottom of the shaft, dug in front of the door and filled the upper part with clayey earth.

BURIALS

There were no burial remains left.

FINDS (PL. XLIX, 5)

- | | |
|---|--|
| <p>1. Terracotta figure with a bell-shaped body, female breasts, arms lifted up; on head a ram's mask. Upper part of arms missing. Decoration of crossed lines with zigzag lines between on body in front; on back laticings; short lines on ram's head; encircling lines round breast. Length 8.o. In the filling.</p> | <p>Besides, numerous potsherds were found in the filling of the chamber. These sherds are exclusively of Type I though some late in style: White Painted I, Bichrome I, Black Slip I, Black Slip Painted I, and Plain White I.</p> |
|---|--|

CHRONOLOGY

This combination of pottery types assigns the tomb to the later part of Cypro-Geometric I.

TOMB 420 (Figs. 82; 87: 8—12)

	SIZE			
	Length	Width	Depth	Height
Dromos	5.10	0.85	1.92	—
Stomion	0.44	0.77	—	0.87
Chamber	3.02	2.16	—	c. 0.95

SHAPE

The dromos is of the narrow passage type, widening at the bottom towards the door. The side walls narrow upwards especially near the back part of the dromos. The entrance is cut vertically down and then the floor slopes gradually to the door. About 1.50 m. from the entrance, there is a rock-cut channel, about 0.60 m. in diameter, across the dromos, and which continues on both sides of it. It was not followed, but has nothing to do with the tomb as it was filled with cultivated earth from the surface layer. Probably it is a ditch cut to lead off the water, in connection with the construction of the later cultivation terraces on this site. 0.55 m. from the door there is a shallow, oblong niche cut in the left side wall of the dromos, about 0.65 m. above its floor. The floor of the niche is horizontal, and its roof slopes towards the back wall. It was closed by three slabs of stone. The door, occupying the whole width of the dromos, is roughly rectangular with rounded corners, and was closed by the usual packing of rough stones. It opens on to the chamber near the left end of its front wall, and the floor of the dromos descends to that of the chamber by

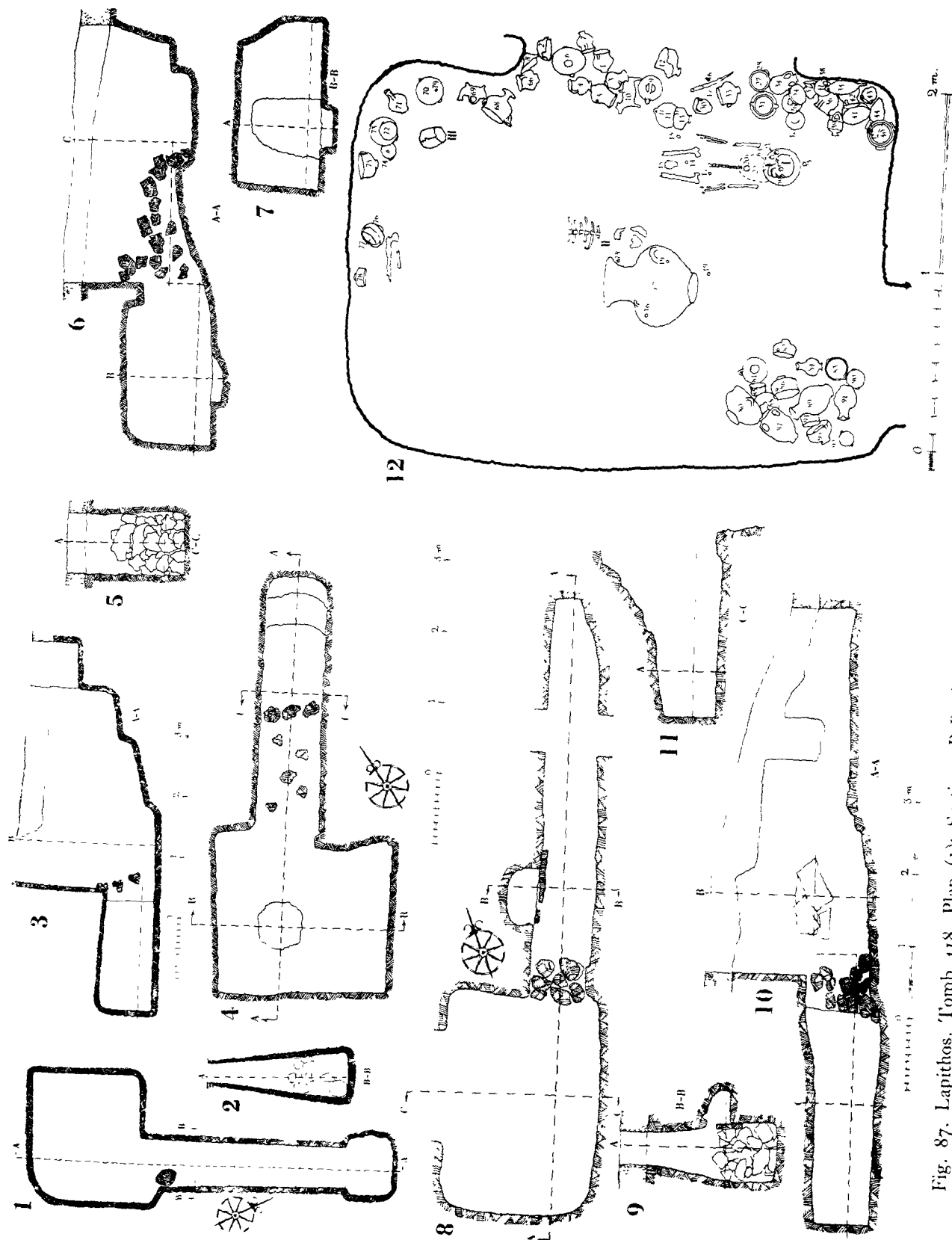

Fig. 87. Lapithos. Tomb 418, Plan (1); Sections B-B, A-A (2, 3). Tomb 419, Plan (4); Sections C-C, A-A, B-B (5-7). Tomb 420, Plan (8); Sections B-B, A-A, C-C (9-11); Finds *in situ* (12).

an oblique step. The chamber is roughly rectangular in plan with rounded corners. The floor and the roof are approximately horizontal. The right part of the roof, together with the part of the right wall separating the chamber from that of Tomb 417, have collapsed, so that there is a connection between the two chambers.

STRATIFICATION

The filling of the dromos consisted of intact layers of *chavara*. In the chamber there was a single burial and culture stratum at the bottom, covered by an upper filling of rock from the collapsed roof, and infiltrated *chavara* from the dromos. All the objects were found on the floor, or in the burial stratum approximately in their original positions except for some finds along the right wall, which had been moved from their original position by the collapse of the rock wall, and to some extent, slipped down through the open hole on to the debris covering the contents of Tomb 417.

BURIALS

Three bodies had been buried in the chamber. Of the skeleton of the first body (Skeleton I), the skull, the spinal column, the upper extremities, and the femora were preserved in a dorsal, outstretched position with the head towards the front wall resting in a flat bowl (No. 29). The body was female and richly adorned with gold ornaments. On the fingers were gold finger-rings (Nos. 14, 17); in the ear, gold earrings (Nos. 15, 21), and round the neck, a necklace of gold beads with a circular pendant (Nos. 20 and 22 a). Beside this skeleton, were scanty remains of Skeleton II, which has been placed with the head towards the front wall, along the left side of Skeleton I. Finger-rings and earrings of gold (Nos. 16, 18, 19) have adorned the body, indicating that it was female. Of Skeleton III the skull, parts of the spinal column and the femora were preserved. The body has been placed along the back wall in a dorsal, outstretched position with the head near the right wall, but the bones have been somewhat disturbed. The tomb-gifts in the usual stock of pots, a bronze bowl (No. 2) and a stone vase etc. (No. 45), were arranged in groups close to the bodies and a large amphora (No. 67) was placed in the middle of the chamber as centre piece. The niche contained remains of a child's skeleton with the skull, the spinal column, parts of the pelvis, right humerus, the femora, and tibiae preserved. From the position of the bones it seems evident that the child had been placed with outstretched legs sitting in a bowl (No. 1). After the putrefaction of the corpse, the back and the head fell towards the opening of the niche. Besides the bowl in which the child was sitting, tomb-gifts had been offered in a jug.

Finally, there were remains of two skeletons found in the middle of the dromos, placed in outstretched, dorsal positions with the heads towards the entrance of the dromos. There were no tomb-gifts in connection with these skeletons; probably, they represent burials of slaves killed at the funeral of the deceased, buried in the tomb-chamber (cf. p. 228).

FINDS (GROUPS: PLS. LII, LIII; TYPES: L. OF PL. II)

C h a m b e r

1. Plain White I amphoriskos with low foot; squat, bi-conical body; slightly concave, wide neck; flat rim; handles from rim to shoulder. Height 11.0. Floor.
2. Rather shallow bronze bowl with round base and contracted rim. Diam. 12.5. Floor.
3. White Painted I oval amphoriskos with low foot; depressed globular body; concave neck; splaying rim; horizontal handles on belly. Encircling band round neck, shoulder, belly, and base. Height 12.2. Floor.
4. Plain White I amphoriskos, as No. 1, but with depressed globular body. Height 9.8. Floor.
5. White Painted I amphoriskos, shape as No. 3. Encircling bands round neck, shoulder, belly, and base; transverse lines on rim; two wavy lines round belly. Height 13.6. Floor.
6. White Painted I deep, funnel-shaped bowl with flat bottom; concave sides; flat rim; two horizontal handles below rim. Encircled wheels inside and on base; a ring of lattice triangles between concentric circles inside the rim; groups of transverse lines on rim; on the outside, encircling lines and bands and a frieze of hatched, inverted triangles below rim. Diam. 19.0. Floor.
7. Plain White I amphoriskos, as No. 1. Height 11.0. Floor.
8. White Painted I bowl, shape as No. 6. Broad bands with encircling lines between on lower part of body; frieze of lattice triangles below rim. Diam. 16.5. Floor.
9. White Painted I oval jug with base-ring; short, concave neck; splaying rim; tubular spout on shoulder; basket-handle. Encircling lines and bands round rim, neck, shoulder, belly, and base; a frieze of framed lattice triangles round shoulders; ladder-pattern on handle. Height 20.5. Floor.
10. White Painted I goat-shaped vase with four legs; basket-handle on back; tubular mouth; horns, ears, eyes, and beard modelled. Along the sides of body latticed bands and bands of lattice lozenges; in front a lattice triangle; along legs vertical and latticed ornaments; on head and neck irregular strokes. Handle, horns, and spout on back missing. Length 21.0. Floor.
11. White Painted I plate with base-ring; one horizontal handle and shaft opposite the handle. Concentric circles inside the bottom and on base; transverse lines on rim and handles; a star-ornament of zigzag lines round base-ring. Diam. 13.4. Floor.
12. White Painted I open bowl, with low foot; softly curved outline; two horizontal handles. Encircling lines and bands round rim, belly, and foot; two short-rippled wavy lines below rim. Diam. 19.0. Floor.
13. White Painted I open bowl with low foot; softly curved outline; vertical handle from rim to body. Encircling bands round rim, belly, and base. Diam. 12.6. Floor.
14. Circular, flat finger-ring of thin gold decorated with an impressed line. Diam. 1.9. Floor.
15. Thick earring of gilded bronze of the boat-shaped type. Diam. 2.1. Floor.
16. Circular, plain finger-ring of gilded bronze. Diam. 2.1. Floor.
17. Circular, flat finger-ring of thin gold. Diam. 1.8. Floor.
18. Circular earring of gold, slightly swollen below and with a flat knob; overlapping ends. Diam. 1.5. Floor.
19. A pair of boat-shaped earrings of gold with overlapping ends. Diam. 1.6. Floor.
20. Circular gold pendant with central cone; framed, twisted strings around cone and edge; fluted tube on the edge of disc by which pendant was threaded on a necklace. Diam. 3.4. Floor.
21. A pair of boat-shaped earrings of gold with overlapping ends; a cluster of small gold balls, and a binding of decorative wire on lower part of circlet. Diam. 2.0. Floor.
22. a) A necklace composed of 65 small, depressed globular gold beads with a string-hole in the middle. Diam. c. 0.3.
b) Biconical, ribbed gold bead with encircling ridges around openings of the longitudinal hole. Diam. 1.1. Floor.
23. Fragments of an iron knife with a preserved iron rivet. Length 1.9. Floor.
24. White Painted I shallow bowl with base-ring; convex sides; two horizontal handles on body. Concentric circles inside; an encircled maltese cross and three groups of filled triangles between concentric circles on base. Diam. 11.6. On Nos. 26, 37.
25. Circular ivory button with one side flat, the other side slightly convex, and a hole pierced in the middle. On convex side an incised rosette encircled by incised lines. Diam. 2.7. Floor.
26. Plain White I amphoriskos, as No. 1. Height 15.5. Floor.
27. White Painted I hemispherical bowl with round base and horizontal handle on body. Encircling line round rim, concentric circles inside; on the outside filled and hatched bands (ladder-pattern) crosswise on body. Diam. 10.0. Floor.
28. Plain White I conical bowl with base-ring and two horizontal handles. Diam. 11.3. Floor.
29. Bichrome I funnel-shaped bowl with flat bottom; concave sides, two horizontal handles below rim. Plain inside; encircling lines and bands around rim and base, a frieze of inverted lattice triangles below rim. Diam. 20.5. Floor.
30. Plain White I amphoriskos, as No. 1. Height 9.6. Floor.
31. Plain White I amphoriskos, as No. 1. Height 13.2. Floor.
32. White Painted I depressed oval amphoriskos with flat base; very short, concave neck, splaying rim; horizontal handles on belly. Encircling bands round rim, shoulder, and belly; two wavy lines round shoulder, lower part of the body covered with black paint. Height 11.0. Floor.

33. Bichrome I depressed pyriform amphoriskos with low foot; wide, concave neck; horizontal handles on belly. Encircling lines and bands round rim, belly, and base; three wavy lines on shoulder. Height 11.6. Floor.
34. Black Slip I pilgrim-bottle with narrow, concave neck; splaying rim; two handles from neck to shoulder. Height 16.0. Floor.
35. White Painted I plate, shape as No. 11. Encircled spiral inside the bottom and four groups of parallel lines, encircled by a plain band, between bottom and rim; on the outside, encircled wheel on base and four groups of filled triangles radiating from base and separated by bands of parallel lines; rim encircled by plain band; ladder-pattern on shaft. Diam. 16.7. On Nos. 38 and 42.
36. Plain White I amphoriskos, as No. 1. Height 12.7. Floor.
37. Plain White I amphoriskos, as No. 1, but with cylindrical neck. Height 8.9. Floor.
38. White Painted I askos with low foot; cylindrical body; cylindrical spout with flaring rim; twin basket-handle on shoulder. Lattice triangles on shoulder, metope decoration of framed lattice rectangles and lozenges round body; ladder-pattern on handle. Height 12.9. Floor.
39. White Painted I askos, as No. 38. Height 12.9. Floor.
40. White Painted I tripod with ridge above legs; concave neck; annular rim. Encircling bands round rim and ridge; a frieze of lattice lozenges and hatched bands round body; on the legs hatched cross; contiguous bands of hatched triangles; horizontal bands of parallel, fringed lines. Height 11.0. Floor.
41. White Painted I shallow bowl with raised base; convex sides and two horizontal, pierced ledge-handles at rim. Transverse lines on rim and handles. Diam. 15.2. Floor.
42. White Painted I amphoriskos with low foot; pyriform body; wide, concave neck; splaying rim; handles from rim to shoulder. Encircling lines round rim, neck, and base; groups of transverse lines on rim; ladder-pattern on handles. Height 12.0. Floor.
43. Plain White I amphoriskos, as No. 1. Height 9.4. Floor.
44. White Painted I fish-shaped vase with short, narrow neck; funnel-shaped mouth; handle from neck to body. Latticed bands and bands with fishbone-pattern along body; transverse lines on handle. Length 22.2. Floor.
45. Oval amphoriskos of greenish steatite with raised, flat base; short, wide, cylindrical neck; plain rim; two knobs on shoulder. Incised decoration; a frieze of hatched, contiguous triangles framed by parallel lines around shoulder, framed band of ladder-pattern on neck; encircling latticed band below rim; vertical bands of ladder-pattern on body. Height 7.7. Floor.
46. Curved iron knife with one cutting edge; pointed end; flat tang pierced by three rivets. Traces of wood still visible on tang. Length 26.0. Floor.
47. Fragments of Plain White I miniature vase. Floor.
- 48.* White Painted I deep, depressed ovoid bowl with flat base; flat rim, sloping inwards; two string-holes at rim. Ladder-pattern on rim; around base encircling lines and bands; on body contiguous bands of hatched triangles and rows of chevrons. Height 12.7. Floor.
49. White Painted I jug, similar to No. 9, but with low foot; depressed globular body and narrower, concave neck. Decoration as No. 9. Height 16.3. Floor.
50. Bichrome I plate with base-ring; vertical, raised rim; one angular handle at rim and shaft opposite the handle. Hatched band around rim; encircled crossed lines on base. Bichrome, concentric circles around base; a ring of filled triangles between rim and base; dots and strokes on shaft-handle. Concentric circles inside. Diam. 12.7. Floor.
51. White Painted I bowl, shape as No. 6, covered with black paint inside; on the outside encircling lines and bands round rim and the lower part of body; metope decoration of framed, vertical zigzag lines below rim. Diam. 15.8. Floor.
52. White Painted I bowl, shape as No. 24. Encircling line round rim; concentric circles inside and around base. Diam. 9.3. Floor.
53. White Painted I bowl, shape as No. 41, but with base-ring. Encircling line around rim; concentric circles and central dot inside; hatched, concentric bands outside; a ring of filled triangles around base. Diam. 14.6. Floor.
54. White Painted I plate with base-ring and two horizontal handles. Encircling lines and bands outside and inside. Diam. 18.7. Floor.
55. White Painted I shallow bowl with base-ring; convex sides; one horizontal handle at rim. Encircling line round rim; concentric circles inside; a ring of filled triangles around base; concentric circles between base and rim; metope decoration of filled rectangles framed by vertical lines around the rim. Diam. 14.0. Floor.
56. Plain White I amphoriskos, as No. 1, but with rather depressed pyriform body. Height 12.7. Floor.
57. Plain White I amphoriskos, as No. 56. Height 15.1. Floor.
58. White Painted I amphoriskos with low foot; conical, depressed body; wide, short neck tapering upwards; splaying rim; handles from rim to shoulder. Decoration as No. 42. Height 13.7. Floor.
59. White Painted I double-conical, deep bowl with low foot; flaring rim; two horizontal handles on belly; a miniature bowl perched on one of the handles. Encircling lines and bands round rim, belly, and base; framed field of chequered lattice lozenges on shoulder. Height 13.1. Floor.
60. Plain White I amphoriskos, as No. 56. Height 10.7. Floor.
61. White Painted I amphoriskos, as No. 5, but with slim, oval body. Height 13.6. Floor.
62. Plain White I amphoriskos, as No. 1. Height 12.6. Floor.
63. White Painted I globular jug with wide, short, concave neck; pinched mouth; basket-handle. Encircling lines and bands round rim, shoulder, belly, and base; ladder-pattern on handle. Height 13.4. Floor.

* By mistake Nos 48—65 were taken up from the tomb before drawing and, therefore, are not marked on the plan, Fig. 87.

64. White Painted I amphoriskos, shape as No. 42, but with concave neck, tapering upwards. Encircling lines round rim and base of neck; broad band on belly; lower part of the body covered with black paint. Groups of transverse lines on rim; ladder-pattern on handle; friezes of parallel, oblique lines on neck and shoulder. Height 17.1. Floor.
65. White Painted I cylindrical askos with flat base; short, cylindrical spout with flaring rim; basket-handle on top. Encircling lines round body and base; framed triangles filled with lattice chequers on top; a frieze of lattice lozenges round body. Height 9.4. Floor.
66. Plain White I amphoriskos, as No. 1. Height 10.1. Floor.
67. White Painted I depressed amphora with base-ring; concave, wide neck; splaying rim; horizontal handles on belly and two small, vertical handles on shoulder. Encircling lines and bands round rim, neck, shoulder, and belly; three wavy bands round belly; groups of transverse lines on rim; ladder-pattern on the small handles; on shoulder vertical, latticed bands; zigzag lines; framed, filled hour-glass ornaments. Height 52.0. Floor.
68. White Painted I deep bowl, shape as No. 59. Encircling bands round rim, belly, and foot; a broad frieze of framed lozenges, arranged in two contiguous rows between handles. Height 16.5. Floor.
69. White Painted I animal-shaped askos with four legs; cylindrical spout with flaring rim projecting from fore-end; basket-handle on back. Two horizontal, contiguous bands of lattice lozenges on body; narrow, encircling bands and vertical lines on spout. Black paint on handle, feet, and belly. Length 15.6. Floor.
70. White Painted I bowl, shape as No. 24. Maltese cross on base; four groups of filled triangles between encircling lines around base and below handles. Diam. 15.0. Floor.
71. White Painted I depressed globular jug with low foot; neck slightly tapering upwards; pinched mouth; handle from rim to shoulder. Encircling lines and bands round rim, neck, shoulder, and base; lattice triangles on shoulder; a wavy band along handle. Height 15.7. Floor.
72. White Painted I shallow, conical bowl with low foot; curved outline; profiled rim; two horizontal handles. Concentric circles outside and inside; transverse lines on rim; a wavy line below rim. Diam. 10.0. In No. 73.
73. Plain White I shallow bowl, as No. 41. Diam. 16.3. Floor.
74. White Painted I bowl, as No. 12, but without short-rippled wavy lines. Diam. 8.7. Floor.
75. White Painted I bowl, as No. 13. Diam. 14.5. Floor.
76. White Painted I bowl, as No. 13. Diam. 12.5. Floor.
77. Black Slip I hemispherical bowl with base-ring; two pierced horizontal handles at rim. Fluted body and horizontal, grooved lines below rim. Diam. 10.6. In No. 76.
78. White Painted I bowl, as No. 74. Diam. 10.0. Floor.
79. Circular, flat finger-ring of bronze with slightly overlapping ends. Diam. 1.8. Floor.
80. White Painted I bowl, shape as No. 12. Encircling bands round rim, body, and foot. Metope decoration of framed latticed bands; chequered lattice lozenges framed by parallel lines below rim. Diam. 23.8. Floor.
81. White Painted I bowl, as No. 13. Diam. 14.8. Floor.
82. White Painted I bowl, as No. 74. Diam. 11.3. Floor.
83. White Painted I bowl, as No. 74. Diam. 11.2. Floor.
84. Black Slip I depressed oval jug with low foot; concave, rather narrow neck; handle from rim to shoulder. Fluted body. Height 13.3. Floor.
85. White Painted I bowl, as No. 74. Diam. 9.9. Floor.
86. White Painted I bowl, as No. 13. Diam. 14.5. Floor.
87. Black Slip I depressed oval amphora with low foot; concave neck; profiled rim; handles from neck to shoulder. Fluted body. Height 22.3. Floor.
88. White Painted I depressed oval jug with low foot; short, concave neck; pinched mouth; handle from rim to shoulder. Encircling lines and bands round rim, neck, shoulder, and base; groups of short strokes pendant from base of neck and handle. Height 23.7. Floor.
89. Plain White I oval jug with base-ring; a ridge around base of neck; concave neck; annular rim; handle from neck to shoulder. Height 23.7. Floor.
90. White Painted I bowl, as No. 74. Diam. 10.0. Floor.
91. Black Slip I oval jug with base-ring; short, concave, rather wide neck; pinched mouth; handle from rim to shoulder. Fluted body and three horizontal, grooved lines round shoulder. Height 18.2. Floor.
92. White Painted I bowl, shape as No. 12. Encircling lines and bands round rim, belly, and base; metope decoration of a lattice lozenge flanked by bands of vertical, parallel lines on body between handles. Diam. 7.9. Floor.
93. White Painted I bowl, as No. 13. Diam. 14.1. Floor.
94. White Painted I bowl, as No. 74. Diam. 10.5. Floor.

D r o m o s n i c h e

1. Bichrome I plate with raised base; a horizontal handle at rim and a shaft opposite the handle. Encircling lines and bands round base; a band of fishbone-pattern flanked by two lattice triangles on base; concentric circles inside. Diam. 17.5. Floor.
2. Coarse oval jug with flat base; wide, concave neck; flat base; and handle from rim to shoulder. Height 7.0. Floor.

BURIALS

In the niche remains of two bodies were found. Cf the first the skull, the right humerus, fibula, part of the spinal column, and the right femur were found, in such a position that it is evident that the body had been placed in an outstretched position with the head at the north end of the niche. Cf the other body, only the skull was found (but not *in situ*) lying on its left side near the pelvis of the first skeleton. Tomb-gifts in pots, were placed in the south part of the shaft.

FINDS (GROUP: PL. LIV, I; TYPE: L. OF PL. II)

- | | |
|--|--|
| <p>1. White Painted III oval amphora with base-ring; cylindrical neck; annular rim; horizontal handles on shoulder. Encircling lines and bands round rim, neck, shoulder, and belly; short-rippled wavy line round belly. Height 32.1. Floor.</p> <p>2. Coarse oval jug with base-ring; wide, cylindrical neck; vertical handle from rim to shoulder. Height 13.6. Floor.</p> <p>3. Black-on-Red I (III) jug with base-ring; nearly cylindrical, short neck; pinched mouth; twin-handle from rim to shoulder. Groups of intersecting, concentric circles around body; crossed lines in front, flanked by small</p> | <p>concentric circles; an eye-ornament on each side of rim; three encircling lines around neck, below rim. Height 30.2. Floor.</p> <p>4. Fragments of Black-on-Red I (III) open bowl with base-ring; of angular outline. Diam. c. 10.0. Floor.</p> <p>5. White Painted III deep plate with flat base and one pierced, horizontal handle at rim. Encircling lines and close concentric circles outside and inside. Diam. 12.9. Floor.</p> <p>6. Fragments of Red Slip I (III) bowl, shape as No. 4. Diam. c. 20.0. Floor.</p> |
|--|--|

Summing up the classification given in the Object Register, we obtain the following diagram:

P o t t e r y			
Wh. P. III	Bl.-on-R. I (III)	R. Sl. I (III)	Coarse ware
1. 5	3. 4	6	2
-2	-2	-1	-1

CHRONOLOGY

As shown by the classification the pottery is entirely of Type III: White Painted III, Black-on-Red I (III), and Red Slip I (III). The specimens are generally late in style and assigns the tomb to the end of Cypro-Geometric III.

TOMB 422 (Figs. 88—93; 94: 3—6; 95: 5)

SIZE

	Length	Width	Depth	Height
Dromos	4.75	1.04	2.25	—
Stomion	0.22	0.80	—	0.80
Chamber	2.10	1.70	—	c. 0.95

SHAPE

The dromos is of the passage type, medium-sized with walls widening slightly upwards. Its entrance is vertical whence it slopes gradually to the door but for a step in the middle. The stomion was closed by the usual packing of rough stones. It is wide, rectangular in



Fig. 88. Lapithos. Tomb 422, dromos. Remains of human sacrifices covered by stone slabs.



Fig. 89. Lapithos. Tomb 422, dromos. Skeletons after removal of stone slabs.

shape with rounded corners and rather short; it opens on to the chamber near the right end of its front wall; its floor descends to that of the chamber by a gradual slope. The chamber is trapezoid in shape with oblique back and right walls and rounded corners; the right wall separating this chamber from that of Tomb 425 is destroyed so that the two chambers communicate. The floor and the roof slope slightly towards the back wall. In the left back part of the roof, the thin rock separating this chamber from that of Tomb 426, which happened to be cut just above this part, has collapsed, and through the hole Tombs 422 and 426 communicate.

STRATIFICATION

The filling of the dromos consisted of a bottom layer of *chavara* mixed with a considerable number of potsherds. Above this was the usual filling of homogeneous *chavara* covered by a layer of dark, sandy earth at about 0.50—0.90 m. from the upper edge of the dromos. The layers in the chamber were composed of:

1) Upper layers of earth and clay mixed with sand and occasional rubble-stones, which



Fig. 90. Lapithos. Tomb 422, dromos with sacrificial table *in situ*.

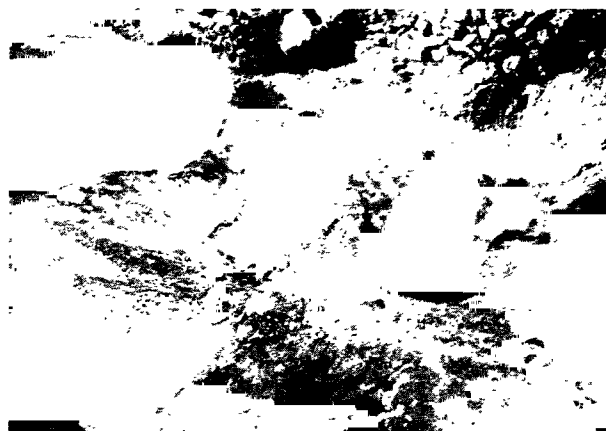

Fig. 91. Lapithos. The dromoi of Tombs 426, 422, 425 (from the left to the right).

have come from the chamber of Tomb 426, through the hole in the roof, and containing some of the contents of that tomb (cf. below p. 254).

- 2) Rock material from the collapsed roof.
- 3) Layers of gravel and infiltrated, sandy earth and clay with occasional rubble-stones brought in by the rain, partly from the dromos, partly from the chamber of Tomb 425, possibly from the door-packing of that tomb (cf. below p. 249).
- 4) A burial layer covered by a layer of broken rock and infiltrated earth.
- 5) Another burial and culture stratum on the rock floor, covered by a layer of *chavara*.

There are, consequently, two burial periods as already indicated by the stratification of the dromos, where fragments of the pottery of the earlier burial period were found in the bottom stratum. The following objects belong to the first burial period: Nos. 8, 9, 11—13. The second burial layer only contained the object No. 10. The following numbers are intrusive from Tomb 425: Nos. 1, 7, and from Tomb 426: Nos. 2—6.

BURIALS

Of the bodies of the first burial period, only scattered remains were left. They were destroyed at the time of the second burial, together with most of the finds which were partly thrown out in the dromos, partly smashed in the chamber and covered with a *chavara* layer (cf. above). On the level of the second burial stratum, a well preserved male skeleton was found along the left wall of the chamber in a dorsal, outstretched position with the head towards the front wall. The upper part of the skeleton has been moved slightly towards the left wall; near the left humerus, part of an iron pike (No. 10) was found, but no tomb-gifts in pots had been offered to the deceased warrior. In compensation sacrifices of human victims were performed at the funeral and remains of these were found in the dromos, on the level between the upper stratum and the second *chavara* filling of the dromos. At the entrance of the dromos lay the remains of three skeletons placed one upon another, the uppermost covered from the breast to the feet by two stone slabs in the shape of a plank-shaped idol similar to those of the Cypriote Bronze Age, and a small slab of

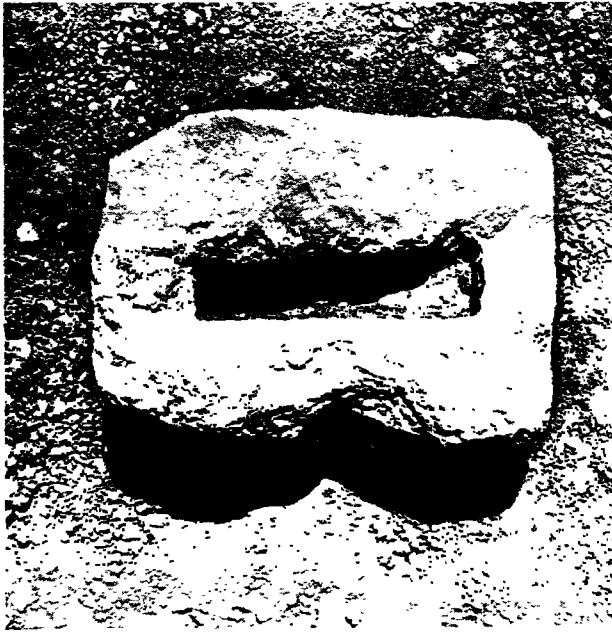

Fig. 92. Lapithos. Tomb 422. The sacrificial table.



Fig. 93. Lapithos. Tomb 422. Stomion with sculptured door-jamb.

stone placed across his neck. When the stone slabs had been removed, it was found that the uppermost skeleton lay in an outstretched position with the head towards the South, but the shoulder-blades were on the top of the ribs, the processes of the spinal column were turned up, the hands were tied to each other and the feet were crossed. From this it was concluded that the body had been placed on its face with its hands and feet tied. Below the knees of the uppermost skeleton, the skull and scattered bones of the second were found. From the position of the bones it seems that the body has been placed there in a mutilated condition. Below this second skeleton, finally, the remains of a third came to light; it was found in a damaged state, but it could be seen that the body had been placed in an outstretched position on its right side with the head towards the North. At the east side of the skeleton one jug and one amphora were found, having contained food and drink. The finding of these skeletons must be connected with that of a large rectangular block of porous stone, which was found lying obliquely in the uppermost dromos-filling above the door, with its upper edge reaching the right rock edge of the dromos. This block measures 1.18 m. in length, 0.51 m. in width, and 0.34 m. in height. In the middle, a rectangular hole is cut, 0.23 m. by 0.12 m. From the short sides of this hole, hollow grooves run to the long sides of the block and down these to about the middle of them. At the place where the blocks were found, there were cuttings in the rock edge of the dromos, whereby it could be concluded that the block had originally been placed across the dromos. These facts seem to have to be explained in the following way: The stone block is a sacrificial table, where human sacrifices have been performed, the remains of which were the skeletons found. When the victims with their hands and feet tied had been killed, their blood poured down in the hole to satisfy the spirit of the deceased, buried in the tomb, and they

CHRONOLOGY

The intact vases found in the first burial stratum are exclusively of Type I: White Painted I and Black Slip I. Besides, numerous potsherds of the same type were found in the burial stratum, assigning the first burial period to the early part of Cypro-Geometric I.

The only two intact vases belonging to the second burial stratum are of advanced Type III: Black-on-Red I (III) ware. Besides, numerous potsherds of White Painted II, White Painted III, Bichrome II—III, and Black-on-Red I (III) were found in this stratum in the chamber, and assign the second burial period to the later part of Cypro-Geometric III.

TOMB 423 (Fig. 94: 7—9)

	SIZE			
	Length	Width	Depth	Height
Dromos	2.75	0.78	1.65	—
Stomion	0.22	0.72	—	0.72
Chamber	1.83	2.45	—	0.85

SHAPE

The dromos is a short passage, rectangular in plan, walls narrowing upwards, and descending to the door by three wide, sloping steps. The door is roughly trapezoid in shape with rounded corners, and occupies the whole width of the dromos. It was closed by the usual packing of rough stones, loosely built and not intact. The door opens on to the chamber to the left of its longitudinal axis, and the floor descends to that of the chamber by a gradual slope. The right front wall and the right side wall are straight; in the back wall an apsidal niche seems to have been intended. The left part of the back wall and the left side wall of the chamber are unfinished. The roof and floor are approximately horizontal.

STRATIFICATION

The filling of the dromos consisted of the usual *chavara*, which was intact in the forepart of the dromos, but in front of the door interrupted by a wedge-shaped layer of darker, loose earth indicating a refilled shaft dug by robbers who had entered the tomb, a fact, also indicated by the disturbed door-packing. This was verified by the stratification and the circumstances of finds in the tomb-chamber itself, which contained a layer of infiltrated earth from the dromos mixed with a disturbed burial layer containing fragments of pottery and scattered bones together with two intact pots left by the robbers.

BURIALS

There were no intact burial remains left.

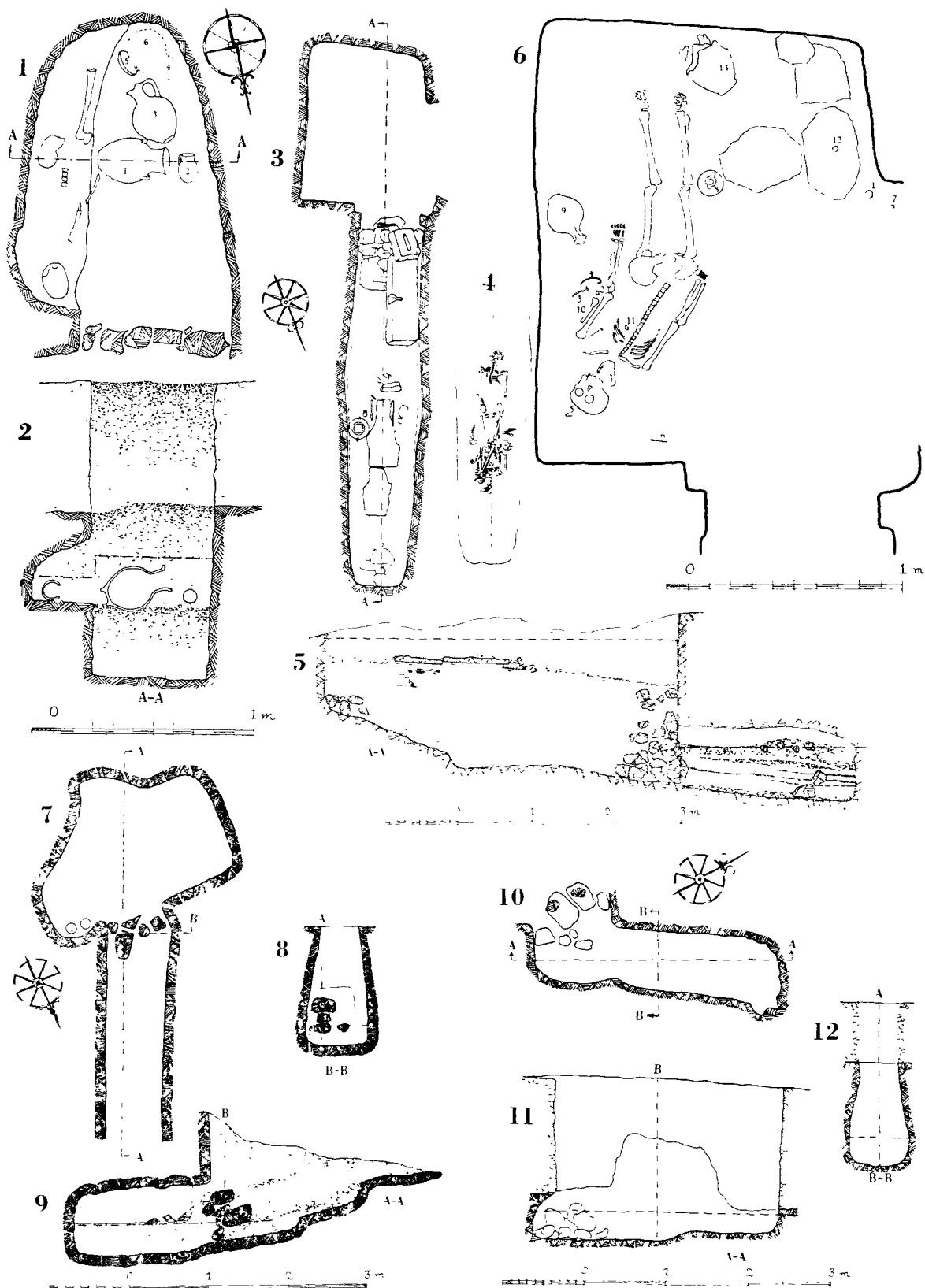

Fig. 94. Lapithos. Tomb 421, Plan (1); Section A-A (2). Tomb 422, Plan (3); Skeletons in dromos (4); Section A-A (5); Finds *in situ* (6). Tomb 423, Plan (7); Sections B-B, A-A (8, 9). Tomb 424, Plan (10); Sections A-A, B-B (11, 12).

FINDS (PL. LIV, 6)

- | | |
|---|---|
| 1. White Painted I bowl with low foot; softly curved outline; two horizontal handles. Encircling bands round rim, body, and base; the same decoration inside. Diam. 10.6. In the filling. | Diam. 11.4. In the filling. |
| 2. White Painted I bowl, as No. 1, but decoration faded. | Besides these numbered objects, several potsherds of White Painted I—II, Bichrome II, and Black Slip I—II were found in the chamber. The sherds of Type II are in majority. |

CHRONOLOGY

This combination of pottery types assigns the tomb to the later part of the Cypro-Geometric II.

TOMB 424 (Fig. 94: 10—12)

	SIZE		
	Length	Width	Depth
Shaft	2.96	0.80	1.25

SHAPE

This tomb was never finished. In cutting its dromos, they happened to make a hole in the roof of a tomb-chamber below. The cutting of the tomb-chamber was therefore abandoned, and the hole blocked up with stones. The dromos has the shape of the usual passage type with curved walls narrowing upwards.

STRATIFICATION

The dromos was filled with *chavara* covering a thin burial layer in the lower part.

BURIALS

On the floor close to the stones blocking up the hole, already mentioned, fragmentary remains of a skeleton were found, together with a bronze fibula for fastening the dress and a jug having contained tomb-gifts to the dead.

FINDS (PL. LIV, 6)

- | | |
|---|---|
| 1. White Painted I depressed oval jug with low foot; concave neck; splaying rim, open spout on shoulder; basket-handle. Encircling lines and bands round rim, neck, and belly; lower part of body covered with black paint. Height 27.7. Floor. | Besides, fragments of White Painted I—II and a stray specimen of Black-on-Red I (III) were found. The specimens of Type II are in majority, and the White Painted I Ware, pot No. 1 included, is generally late in style. |
|---|---|

CHRONOLOGY

This combination of pottery types assigns the tomb to the end of Cypro-Geometric II.

TOMB 425 (Figs. 91; 95: 1—5)

	SIZE			
	Length	Width	Depth	Height
Dromos	2.23	0.78	1.95	—
Stomion	—	0.78	—	0.80
Chamber	2.40	2.30	—	c. 0.90

SHAPE

The dromos is of the short passage type, rectangular in plan and with walls narrowing slightly upwards. At the entrance, it is vertical, and the floor of the dromos slopes gently to the door. The door occupies the whole width of the dromos: it is vertical in shape, and was closed by a stone-packing of rough stones of the usual type. The upper right side of it was missing, and the stones had fallen into the tomb-chamber (cf. the stratification). This was caused by collapse of the rock above the door as seen by the section A-A compared with the plan of the tomb (Fig. 95: 1, 2). The door opens on to the chamber to the left of its longitudinal axis and the floor of the dromos descends to that of the chamber by a gradual slope. The chamber is roughly trapezoid in plan, with the side walls narrowing slightly, rounded corners and a supporting rock pillar projecting from the right of the back wall. The left wall has collapsed, whereby there is communication between this chamber and that of Tomb 422 (cf. above p. 242). The floor rises slightly towards the back wall. The roof was probably horizontal, which can be inferred from an intact part near the back wall: the rest has fallen in. On the left of the chamber there is a cavity, about 0.50 m. deep, cut in the rock floor.

STRATIFICATION

The filling of the dromos consisted of a bottom stratum of *chazara* mixed with numerous potsherds, and an upper stratum of *chazara* without any pottery fragments, indicating two burial periods, the waste of the first burial period being thrown out in the dromos at the time of the second burial period. The layers in the chamber were composed of:

- 1) An upper layer of infiltrated earth-filling and stones fallen in from the door-packing.
- 2) A layer of rock from the fallen-in part of the roof.
- 3) A burial and culture stratum on top of the bottom layer.
- 4) Another burial and culture stratum at the bottom.

The collapse of the rock thus happened after the second burial, a part of the stone-packing fell into the chamber and foreign earth infiltrated there.

In the first burial stratum the finds and the burial remains had been disturbed and partly destroyed at the time of the second burial. Only two intact vases were found in the right front corner of the chamber. The rest of the pottery had been purposely smashed and the culture stratum was filled with pottery fragments, which had also been swept into the cavity in the floor, or thrown out in the dromos (cf. above). The gold ornaments of the deceased

and their other personal effects had not been touched by the persons who re-used the tomb. The following objects belong to the first burial period: Nos. 13—23, 42—46. To the second burial period, the following belong: Nos. 1—12, 24—41.

BURIALS

In the first stratum remains of three skeletons were found. Of these the skulls were swept into the right front corner of the chamber and parts of the femora were found near the right back corner. The bodies had been adorned with gold earrings (Nos. 14, 15, 16, 44, 45, 46), a nose-ring of gold (No. 13), beads of paste (No. 17) and of gold (No. 23), a finger-ring of bronze (No. 20). Fibulae (Nos. 19, 21, 22) had been used for fastening the dresses.

In the second burial stratum there were no remains of skeletons, only burial earth along the left wall of the chamber. The body or bodies had been adorned with gold mountings (Nos. 1, 2, 3, 4, 5), finger-rings of gold (Nos. 10, 11), gold diadems (Nos. 7, 8), gold earrings (Nos. 6, 9), and had been provided with a bronze bowl (No. 29) and an iron knife (No. 12). The tomb-gifts in pots were all placed on the right side of the chamber above the skeletal remains of the earlier burials, already swept away.

FINDS (GROUP: PL. LV; TYPES: L. OF PL. II)

1. Circular, thin gold disc, with three holes pierced at edge; decorated with an impressed, encircling line round edge, and an impressed, central dot. Diam. 3.5. Second burial layer.
2. Gold disc, as No. 1. Slightly damaged. Diam. 3.5. Second burial layer.
3. Gold disc, as No. 1. Diam. 3.5. Second burial layer.
4. Gold disc, as No. 1. Diam. 3.5. Second burial layer.
5. Gold disc, as No. 1. Damaged. One half missing. Diam. 3.5. Second burial layer.
- 6 and 9. A pair of "boat-shaped", hollow earrings of gold with overlapping ends, and a cluster of four gold balls added below. Length 3.6. Second burial layer.
7. Oblong diadem of gold with straight ends, pierced by holes, and convex sides. One end broken. The gold is mounted on a curved bronze leaf. Length 10.7. Second burial layer.
8. Diadem of gold, as No. 7. Bronze still preserved. Length 9.0. Second burial layer.
9. See No. 6.
10. Flat, wide finger-ring of gold, fluted round the circlet. Diam. 1.75. Second burial layer.
11. Finger-ring of gold, as No. 10. Diam. 1.65. Second burial layer.
12. Fragment of an iron knife with curved blade; one cutting edge; tang pierced by four bronze rivets. Traces of wood still visible on tang. Length 5.7. Second burial layer.
13. Oblong nose-ring (?) of gold slightly swollen below. Diam. 1.5. First burial layer.
- 14 and 44. A pair of circular gold earrings with overlapping ends; slightly swollen below. Diam. 1.5. First burial layer.
- 15 and 45. A pair of gold earrings, as Nos. 14 and 44. Diam. 2.0. First burial layer.
- 16 and 46. A pair of small, oblong earrings of gold with overlapping ends, and a small cluster of four gold balls added below. Diam. 1.65. First burial layer.
17. Paste bead (dissolved into powder). First burial layer.
18. Flat, circular button of ivory with a hole pierced in the middle; decorated with a rope-ornament, bordered by parallel, encircling lines around edge. Diam. 3.5. First burial layer.
19. Bronze fibula with thin, beaded bow; angular fore-end, single-coiled spring and straight pin. Pin broken. Length 5.2. First burial layer.
20. Fragments of three small, plain finger-rings of bronze. First burial layer.
21. Bronze fibula, as No. 19, but more arc-shaped. Only half preserved. Length 3.7. First burial layer.
22. Fragments of bronze fibula. First burial layer.
23. Biconical gold bead with ribbed body and longitudinal hole; ridges around hole. Diam. 1.1. First burial layer.
24. White Painted I bowl with low foot; softly curved outline; two horizontal handles. Encircling lines round rim, body, and base. Diam. 17.0. Second burial layer.
25. Red Slip amphoriskos with low foot; depressed globular body; slightly concave neck, widening upwards; flat rim; two handles from rim to shoulder. One handle missing. Probably foreign ware. Height 6.8. Second burial layer.

- 26. White Painted I jug with low foot; depressed body; narrow, concave neck; splaying rim; handle from rim to shoulder. Encircling lines round rim, neck, belly, and base; lattice triangles on shoulder; transverse lines on handle. Height 8.5. Second burial layer.
- 27. White Painted I spherical jug with narrow neck; collar-shaped mouth; handle from neck to shoulder. Encircling lines round rim and neck; concentric circles on body; ladder-pattern on handle; a "dog-tooth" ornament in front. Height 11.8. Second burial layer.
- 28. Fragments of White Painted I barrel-shaped jug. Second burial layer.
- 29. Hemispherical bronze bowl with round base; profiled rim; a conical, central boss in the bottom. One third of bowl missing. Diam. 12.9. Second burial layer.
- 30. White Painted I bobbin-shaped jug with angular shoulder; pinched mouth; handle from rim to shoulder. Encircling bands and lines round rim, neck, belly, and base; ladder-pattern on handle. Height 11.9. Second burial layer.
- 31. White Painted I squat jug with rounded base; narrow neck; splaying rim; handle from neck to shoulder. Encircling lines round rim, neck, belly, and base; four lattice triangles meeting in a dot on base. Height 11.2. Second burial layer.
- 32. White Painted I plate with flat base and two horizontal handles at rim. Encircling lines and concentric circles inside and outside; an encircled maltese cross on base. Diam. 11.2. Second burial layer.
- 33. Red Slip Bichrome spherical jug with flat base; narrow neck; concave, collar-shaped mouth; handle from neck to shoulder. Bichrome, encircling lines round rim and neck; four groups of bichrome, concentric circles round belly; ladder-pattern on handle. Probably foreign ware. Height 8.4. Second burial layer.
- 34. White Painted I bowl with low foot; softly curved outline; handle from rim to body. Encircling lines round rim, body, and base; two wavy lines round body. Diam. 12.0. Second burial layer.
- 35. White Painted I plate, as No. 32. An encircled spiral inside; framed zigzag line flanked by two lattice triangles on base; encircling lines outside and inside. Diam. 20.4. Second burial layer.
- 36. White Painted I plate, as No. 32. Encircled spiral inside; framed band of lattice lozenges flanked by two lattice triangles on base; encircling lines outside and inside. Diam. 19.2. Second burial layer.
- 37. Plain White II oval jug with low foot; oval body; cylindrical neck; annular rim; handle from neck to shoulder. Height 16.7. Second burial layer.
- 38. Coarse oval jug with flat base; wide, cylindrical neck; handle from rim to shoulder. Height 8.0. Second burial layer.
- 39. White Painted I spherical jug, as No. 31. Decoration faded. Height 11.4. Second burial layer.
- 40. Fragments of Plain White I cup with one handle. Second burial layer.
- 41. White Painted II bowl, similar to No. 34, but with angular outline. Encircling lines round rim, body, and base. Diam. 12.0. Second burial layer.
- 42. Plain White I funnel-shaped strainer with raised rim and round bottom. Handle missing. Height 8.0. First burial layer.
- 43. Plain White I oval jug with low foot; tall, concave neck; a ridge between neck and shoulder; handle from neck to shoulder. Rim damaged. Height 17.3. First burial layer.
- 44. See No. 14.
- 45. See No. 15.
- 46. See No. 16.

Summing up the classification given in the Object Register and the stratigraphical data, we obtain the following diagram:

	P o t t e r y								Iron	B r o n z e			G o l d					P a s t e I v o r y	
	Wh. P. I	Wh. P. II	Pl. Wh. I	Pl. Wh. II	Coarse W.	R. Sl. (foreign)	R. Sl. Bichr. (foreign)	Knife	Fibula	Finger-ring	Bowl	Nose-ring	Earring	Finger-ring	Diadem	Disc	Bead	Bead	Button
1st burial period			42 43						19 21 22	20		13	14 15 16 44 45 46				23	17	18
			-2						-3	-1		-1	-6				-1	-1	-1
2nd burial period	24, 26 27, 28 30, 31 32, 34 35, 36 39	41	40	37	38	25	33	12		29		6, 9	10	7, 8	1, 2 3, 4 5				
	-11	-1	-1	-1	-1	-1	-1	-1		-1		-2	-2	-2	-2	-5			

CHRONOLOGY

The pottery of the second burial stratum is composed mainly of Type I: White Painted I and Plain White I, and only two specimens of Type II: White Painted II and Plain White II.

In the first burial stratum the two preserved pots are Plain White I Ware; besides, the pottery fragments are of the same types as in the second burial stratum, consisting of specimens of Type I, mixed with sporadic fragments of Type II: White Painted I—II and Plain White I—II. This shows that both the burial periods are approximately contemporary and date from the very beginning of Cypro-Geometric II.

TOMB 426 (Figs. 91; 95: 5—9)

	SIZE			
	Length	Width	Depth	Height
Dromos	2.70	0.66	1.58	—
Stomion	0.20	0.60	—	0.80
Chamber	2.15	2.68	—	0.96

SHAPE

The dromos is of the short passage type with nearly vertical side walls, descending by a rather steep slope to the door. The door is rectangular in plan with rounded corners. The door-packing was missing. The stomion is short, wide, and rectangular in plan. It opens on to the chamber to the left of its longitudinal axis, and the floor of the dromos descends to that of the chamber by a gradual slope. The chamber is roughly trapezoid in plan, with the side walls widening towards the slightly convex back wall. The floor slopes towards the middle of the chamber and the roof is horizontal. The part of the floor, which happened to be above the chamber of Tomb 422, has collapsed, so that these two tombs communicate (cf. above p. 242). There is also a hole in the right back part of the roof caused by another collapse of the rock.

STRATIFICATION

The filling of the dromos consisted of intact layers of *chavara* in front of the door, partly dug out from within (cf. below). The stratification in the chamber and the circumstances of the finds give evidence of that the tomb has been robbed. The layers thus comprised:

- 1) An upper layer of earth brought down through the hole in the roof mixed with stones from the door-packing and *chavara* from the dromos.
- 2) A layer of infiltrated *chavara* from the dromos-filling.
- 3) A thin bottom layer of *chavara* covering the rock floor of the chamber and levelling its irregularities.

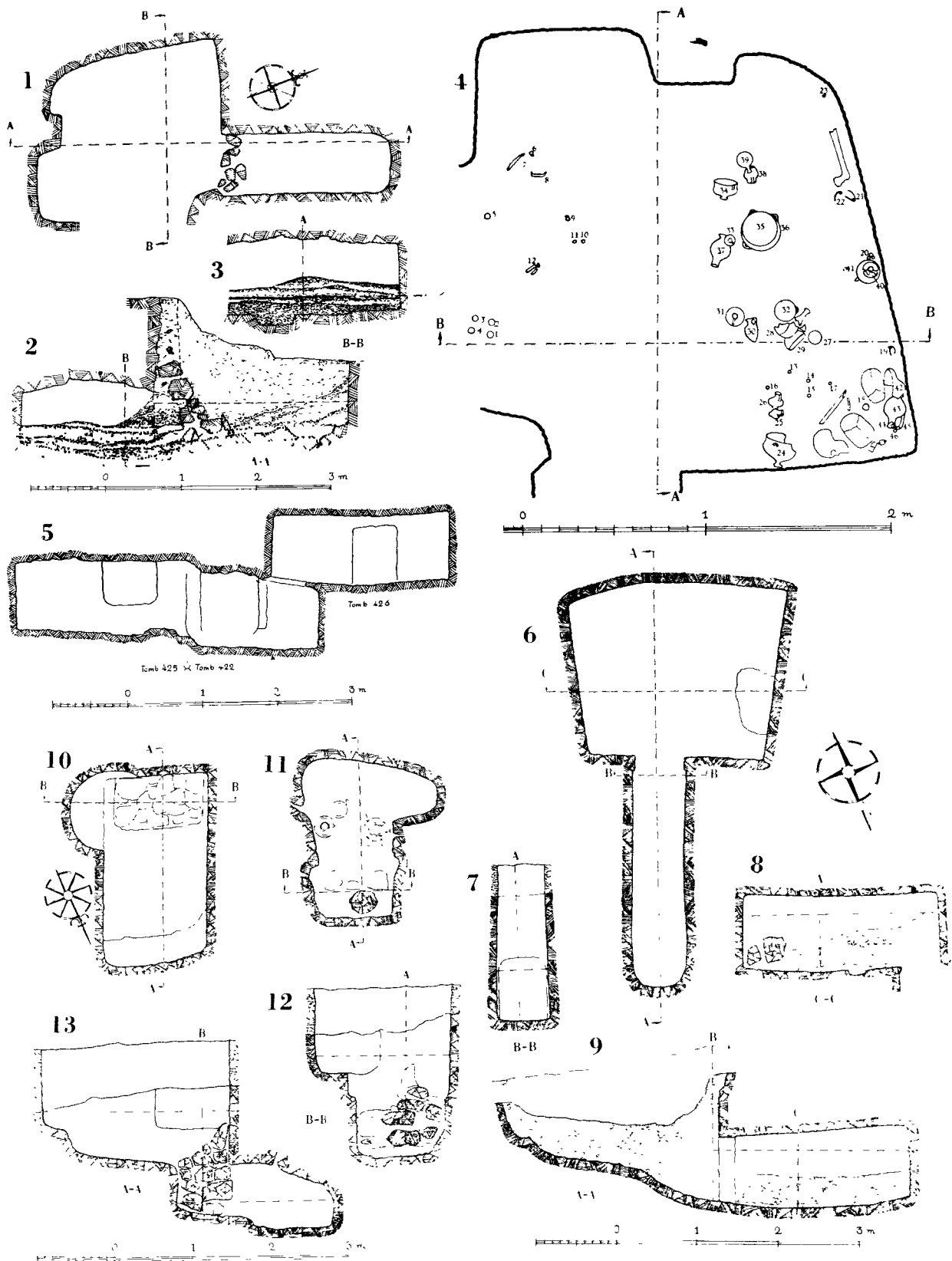

Fig. 95. Lapithos. Tomb 425, Plan (1); Sections A-A, B-B (2, 3); Finds *in situ* (4). Section through chamber of Tombs 425, 422, 426 (5). Tomb 426, Plan (6); Sections B-B, C-C, A-A (7-9). Tomb 427, Plan (10, 11); Sections B-B, A-A (12, 13).

These layers were not distinctly separated but were all turned over and disturbed, and contained fragments of skeletons and masses of potsherds broken by the robbers, and a few minor objects that escaped them. Some of these were found in the upper layers of Tomb 422 (cf. p. 243) brought there with the earth from the hole in the floor. The tomb-robbers had not entered the tomb from the dromos but through the hole in the roof. This is evident from the fact that the stones of the door-packing, which were found in the upper layers of the chamber had been removed from within, after which the robbers cut out a part of the dromos-filling, evidently thinking that the main treasure was hidden behind the stone-packing. Finding that they were mistaken in this they gave up the cutting of the dromos-filling; this was so hard that it has resisted the pressure from above and not fallen into the cave dug out by the robbers. After the visit of the robbers the hole in the floor opened into Tomb 422 and the disturbed filling of Tomb 426 fell into the chamber of Tomb 422, forming the upper layer of its filling (cf. above p. 243).

BURIALS

There were no intact burials left.

FINDS

Some of the original finds of this tomb have intruded through the hole in the floor into Tomb 422, and are described above p. 245 (Tomb 422, Nos. 2—6). Besides, numerous potsherds were found in the disturbed filling of the chamber. They are of the same types as those of Tomb 424: White Painted I—II, and two specimens of Black-

on-Red I (III) Ware, belonging to the same pot, viz. a deep bowl with base-ring and three horizontal, grooved lines around the rim. The fragments of White Painted I Ware are generally late in style and the fragments of White Painted II are in majority.

CHRONOLOGY

This combination of pottery finds assigns the tomb to the end of Cypro-Geometric II.

TOMB 427 (Figs. 95: 10—13; 96)

SIZE

	Length	Width	Depth	Height
Dromos	2.40	1.30	1.00	—
Stomion	0.66	1.14	0.66	—
Chamber	1.45	1.75	—	0.78

SHAPE

The shape of this tomb differs from the general type in this necropolis, but shows some similarities to that of Tomb 404. The dromos is a rather shallow and wide shaft, roughly rectangular in plan, with a step cut at the entrance, and sloping slightly towards the door. On the left of the back end of the dromos there is a semicircular ledge cut in the rock,



Fig. 96. Lapithos. Tomb 427, dromos.



Fig. 97. Lapithos. Tomb 429, dromos.

0.50 m. above the floor of the dromos. The doorway is a roughly rectangular hole opening on to the chamber from above, near the back end of the dromos. This door hole was filled with a packing of rough stones down to the level of the chamber. From the bottom of the door hole, a step leads down to the level of the tomb-chamber. The chamber is of an irregular shape with an oblong, cave-shaped recess at the back. There are crevices in the rock of the side walls.

STRATIFICATION

The dromos was filled with homogeneous *chavara*, which close to the door was hard and petrified. The layers in the chamber consisted of a burial and culture stratum at the bottom, and an upper layer of rock, and *chavara* from the dromos, which also had petrified.

All the objects were found on the floor.

BURIALS

One body had been buried in the tomb. Remains of its skeleton were found in a dorsal, outstretched position along the back wall of the chamber, with the head to the left wall. The tomb-gifts in pots, were placed on the other side of the chamber.

FINDS (GROUP: PL. LIV, 7; TYPE: L. OF PL. II)

1. Black-on-Red I (III) globular jug with base-ring; slightly concave neck; pinched mouth; twin-handle from rim to neck. Encircling lines round rim and neck; intersecting, concentric circles on body; eye-ornament on rim. Height 20.0. Floor.
2. Black-on-Red I (III) oval amphora with base-ring; short, wide neck slightly tapering upwards; flat, thick rim and two horizontal handles on shoulder. Narrow, encircling lines around rim, neck, shoulder, belly, and base; groups of narrow, concentric circles round the neck. Height c. 35.5. Floor.
3. Black-on-Red I (III) open bowl with base-ring; angular

- outline; straight, splaying sides; two horizontal handles. Encircling bands round rim and body. Diam. 11.9. Floor.
4. Black-on-Red I (III) bowl, as No. 3. Diam. 12.6. Floor.
5. White Painted III—IV oval hydria with base-ring; nearly cylindrical neck tapering upwards; flat thick, rim; two horizontal handles on shoulder and one vertical from neck to shoulder. Encircling bands round neck, shoulder, and belly. Lower part missing. Height c. 40.0. Floor.
6. Fragments of Black-on-Red I (III) bowl, as No. 3. Floor.
7. Fragments of Black-on-Red I (III) bowl, as No. 3. Floor.

Summing up the classification given in the Object Register, we obtain the following diagram:

Wh. P. III-IV	Bl.-on-R. I (III)
5 -1	1, 2, 3, 4, 6, 7 -6

CHRONOLOGY

This classification shows that the pottery represented consists of Black-on-Red I (III), and one specimen of White Painted III—IV ware, assigning the tomb to the very end of Cypro-Geometric III.

TOMB 428 (Figs. 98: 1—6; 99; 100)

	SIZE			
	Length	Width	Depth	Height
Dromos	3.80	1.00	2.65	—
Stomion	0.25	0.81	—	0.84
Chamber	2.20	2.40	—	c. 0.95

SHAPE

The dromos is of the medium-sized passage type, widening at the bottom towards the door and with walls narrowing upwards especially near its back part. The entrance is vertically cut, and the floor slopes gradually to the door. At the entrance of the dromos the right rock wall has been apsidally hollowed out, and a row of stones placed across the dromos. The door is rectangular with rounded corners, and was closed by the usual packing of rough stones. The stomion is rectangular in plan and somewhat longer than usual. It opens on to the chamber in its longitudinal axis and its floor descends to that of the chamber by a sloping step. The chamber is trapezoid in plan with the side walls narrowing towards the back and rounded corners. The roof and the floor are approximately horizontal.

STRATIFICATION

The dromos-filling consisted of a lower layer of *chavara* mixed with potsherds at the bottom, and an upper layer without any pottery fragments, indicating repeated burials, the rubbish from the earlier burials having been thrown out in the dromos at the time of

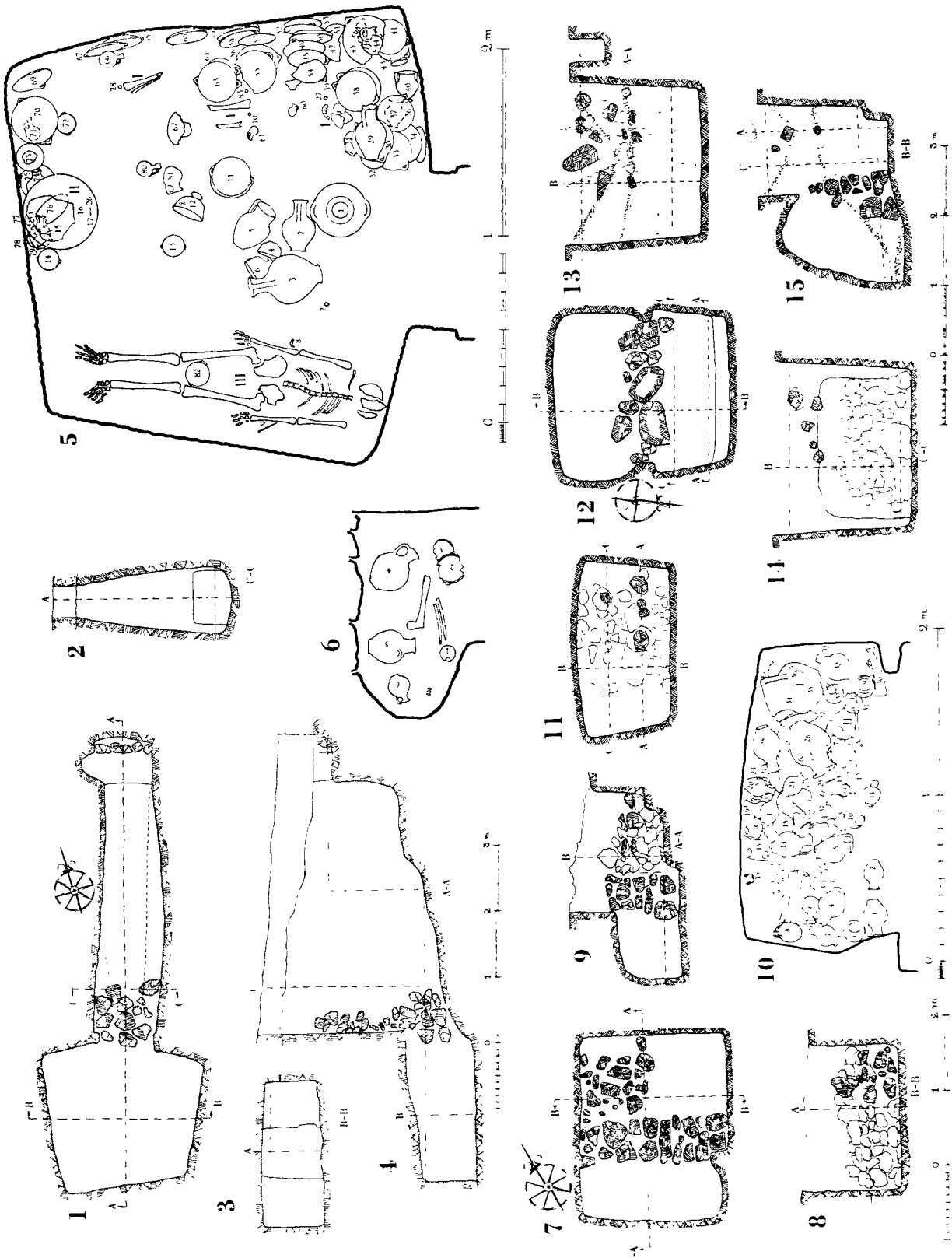

Fig. 98. Iapithos. Tomb 428, Plan (1); Sections C-C, B-B, A-A (2-4); Finds in chamber (5); Finds in dromos (6). Tomb 429, Plan (7); Sections B-B, A-A (8, 9); Finds *in situ* (10). Tomb 601, Plan (11, 12); Sections A-A, C-C, B-B (13-15).



Fig. 99. Lapithos. Tomb 428. Interior of the chamber with finds *in situ*.



Fig. 100. Lapithos. Tomb 428. Interior of the chamber with finds *in situ*.

the later burials. The chamber showed the unusual aspect of finds not covered by any extraneous earth, except close to the door where a thin layer of weathered rock had fallen from the roof. For the rest the skeletons and the tomb-gifts were found uncovered. Two burial periods, however, can be distinguished; at the time of the second burial the skeletal remains of one of the bodies buried in the first burial period were packed into the amphora No. 16, and some of the pots of the earlier burial period were piled upon each other on the right side of the chamber in order to make room for the new body. The objects belonging to this body of the second burial period are the following: Nos. 1—8, 12, 13, 82. All the other objects found in the tomb belong to the first burial period.

BURIALS

In the first burial period two bodies were buried in the chamber. Skeletal remains of the first body were found along the right wall of the chamber with the skull and the femora preserved. The body seemed to have been placed in a dorsal, outstretched position with the head towards the front wall. The find of a spindle-whirl of stone (No. 27) in connection with this skeleton indicates that the body was female. It had a finger-ring of bronze on its right hand (No. 83). The remains of a second skeleton, as mentioned above, were found packed into the amphora No. 16 placed at the back of the chamber. Together with this skeleton were found a bronze fibula (No. 24), a bronze pin (No. 26), a bronze tweezer (No. 25), and six embossed plaques of gold (Nos 18—23) decorated with rosettes. A seventh gold rosette (No. 10) was found between the femora of Skeleton No. I, where it was probably dropped when Skeleton No. II was packed into the amphora. These gold rosettes had probably decorated the head-gear in the same way as those found in Tombs 403, 417, and 425. The skeletal remains of the third body buried in the second burial period were well preserved. They were found along the left wall of the chamber in a dorsal, outstretched position, with the head towards the front wall. The body was female. In connect-

ion with this skeleton a bronze fibula (No. 8) and a bronze pin (No. 9) were found, which had once been used to fasten the dress of the corpse, and a spindle-whirl of stone (No. 7).

In the hollowed-out part near the entrance of the dromos a sub-burial had taken place. Of the skeleton parts of the tibiae, a fibula, a cubital bone, and a femur were preserved in such a position that it can be concluded that the body had been placed in a contracted position with the head towards the short end of the hollowed-out part. Tomb-gifts in six pots, placed round the skeleton, had been offered to the deceased.

FINDS (GROUPS: PLS. LVI, LVII, 2, 3; TYPES: L. OF PL. II)

C h a m b e r

1. White Painted II ovoid amphora with base-ring; slightly concave neck; splaying, swollen rim; two horizontal handles on shoulder. Encircling lines and bands around rim, neck, shoulder, belly, and base; framed lattice triangles on shoulder. Height 36.6. Floor.
2. Black Slip II oval jug with base-ring; slightly concave neck; pinched mouth; handle from rim to shoulder. Fluted body and five horizontal, grooved lines round shoulder. Height 27.2. Floor.
3. Black Slip II oval jug, as No. 2, but with three to four horizontal, grooved lines round shoulder. Height 37.3. Floor.
4. White Painted III bowl with base-ring; angular outline; nearly straight sides; handle from rim to body. Encircling bands inside and outside. Diam. 12.4. Floor.
5. Coarse ovoid jug with flat base; wide, cylindrical neck; handle from rim to shoulder. Height 24.4. Floor.
6. Black-on-Red I (III) open bowl with low foot; angular outline; straight sides, widening upwards; two horizontal handles below rim. Encircling bands round rim, body, and base; a ridge below rim. Diam. 18.5. Floor.
7. Biconical spindle-whirl of steatite with a hole pierced lengthwise; decorated with encircled dots. Diam. 1.6. Floor.
8. Fragment of a bronze fibula with thick, beaded bow. Spring, catch, and pin missing. Length 3.4. Floor.
9. Thin, straight bronze pin with pointed end. Head missing. Length 11.1. Floor.
10. Circular, thin gold disc, decorated with a rosette in embossed work. Diam. 2.0. Floor.
11. White Painted I open bowl with low foot; softly curved outline; two horizontal handles. Encircling bands round rim, body, and base. Diam. 20.0. Floor.
12. White Painted II—III open bowl with low foot; angular outline; straight sides, widening upwards; two horizontal handles. Encircling lines and bands around rim, body, and base; two wavy lines below rim; inside the bottom an encircled spiral. Diam. 17.0. Floor.
13. White Painted III bowl, as No. 4, but with two horizontal handles. Diam. 12.0. Floor.
14. White Painted I bowl, as No. 11. Diam. 10.3. Floor.
15. Black Slip I pyriform jug with low foot; concave neck; pinched rim; handle from rim to shoulder. Fluted body. Height 17.0. On Nos. 78, 79.
16. White Painted I depressed oval, rather pyriform amphora with base-ring and two horizontal handles. Encircling bands around neck, shoulder, belly, and base; groups of leaf-shaped strokes pendant from base of neck. Neck and part of body missing. Height 38.7. Floor.
17. White Painted I spherical jug with short, narrow, concave neck; collar-shaped mouth; handle from neck to shoulder. Four encircled maltese crosses on body, ladder-pattern on handle; encircling lines around mouth and band around base of neck. Height 11.2. In No. 16.
18. Gold disc, as No. 10. Diam. 2.1. In No. 16.
19. Gold disc, as No. 10. Diam. 2.0. In No. 16.
20. Gold disc, as No. 10. Diam. 2.0. In No. 16.
21. Gold disc, as No. 10. Diam. 2.0. In No. 16.
22. Gold disc, as No. 10. Diam. 2.0. In No. 16.
23. Gold disc, as No. 10. Diam. 1.9. In No. 16.
24. Fragment of a fibula with arc-shaped, beaded bow. The beads are decorated with incisions. Spring, catch, and pin missing. Length 4.8. In No. 16.
25. Bronze tweezer with straight, thin arms: loop-shaped top. Length 6.0. In No. 16.
26. Straight, thin bronze pin with pointed end. Upper part missing. Length 6.0. In No. 16.c
27. Spindle-whirl, as No. 7, but without decoration. Diam. 1.5. Floor.
28. Circular, flat finger-ring of bronze. Diam. 2.6. Floor.
29. Black Slip II oval jug, as No. 2, but with five to six horizontal, grooved lines round shoulder. Height 27.2. On No. 30.
30. White Painted I plate with flat base and two horizontal handles. Encircling lines and bands around rim and base; on the base framed lattice triangles forming a secondary cross with a framed lattice lozenge as central ornament; inscribed spiral inside. Diam. 23.0. On Nos. 32, 33, 36.
31. Black Slip II depressed oval jug with base-ring, short, straight neck, widening upwards; pinched mouth; handle from rim to shoulder. Fluted body and three horizontal, grooved lines round shoulder. Height 16.3. Floor.
32. White Painted I—II open bowl with low foot; softly curved outline; handle from rim to body. Encircling lines and bands round rim and base; sweeping lines below rim. Diam. 14.0. Floor.
33. White Painted I plate, shape as No. 30. Encircling lines and bands round rim and base; on base four lattice

- triangles meeting in concentric circles; concentric circles inside. Diam. 21.3. Floor.
34. White Painted I plate, as No. 33, but with a framed band of lattice lozenges flanked by two lattice triangles on base. Diam. 19.8. Floor.
 35. White Painted I plate, as No. 34, but with a pseudo-spiral inside. Diam. 19.8. Floor.
 36. Black Slip Painted I plate with base-ring and two knobbed, horizontal handles. Encircling lines inside rim; an encircled wheel inside the bottom; four framed lattice triangles meeting in an encircled cross on base; body between rim and base covered with black paint and fluted. Diam. 19.4. Floor.
 37. Black Slip I pyriform amphoriskos with low foot; wide, concave neck; out-turned rim; vertical handles from rim to shoulder. Fluted body and three horizontal, grooved lines round shoulder. Height 12.9. Floor.
 38. White Painted I plate, as No. 30, but an encircled wheel-ornament inside, and triangles and lozenge on base not framed. Diam. 21.5. Floor.
 39. White Painted I plate with wide base-ring and two horizontal, knobbed handles. Encircling lines and bands around rim and base; on base a framed band of lattice lozenges flanked by four lattice triangles; an inscribed spiral inside; transverse lines on rim and base-ring. Diam. 23.1. Floor.
 40. Black Slip I amphoriskos, as No. 37, but with five horizontal, grooved lines round shoulder. Height 15.4. Floor.
 41. White Painted I plate, shape as No. 39. Encircling lines and bands around rim and base; concentric circles inside; four lattice triangles meeting in concentric circles on base. Diam. 19.0. In No. 42.
 42. White Painted I plate, shape as No. 30. Decoration as No. 41, but the triangles meet in a central dot on base. Diam. 19.2. Floor.
 43. Black Slip I amphoriskos, as No. 37. Height 13.8. Floor.
 44. Black Slip I jug, as No. 31. Height 14.8. Floor.
 45. White Painted I plate, shape as No. 30. Decoration as No. 39, but the band of lattice lozenges is flanked by two lattice triangles. Diam. 26.5. Floor.
 46. White Painted I goat-shaped vase with four legs; a vertical, tubular spout on back; friezes of latticed squares on both sides of body; a framed lattice triangle in front. Main decoration faded. Length 10.3. Floor.
 47. White Painted I plate, as No. 39; decoration as No. 34. Diam. 19.5. Floor.
 48. Bichrome I-II plate with base-ring and two knobbed, horizontal handles. Encircling lines and bands; concentric circles inside; five lattice triangles meeting in bichrome, concentric circles on base; six lattice triangles between rim and base. Diam. 20.8. Floor.
 49. White Painted I plate, shape as No. 39, but with narrower base-ring. Encircling lines and bands around rim and base; an encircled wheel inside; four lattice triangles meeting in a small encircled dot on base; transverse lines on base-ring. Diam. 22.9. Floor.
 50. White Painted I plate, as No. 42, but with lattice triangles meeting in concentric circles. Diam. 23.0. Floor.
 51. White Painted I plate, as No. 42, but with an encircled dot inside. Diam. 21.0. Floor.
 52. White Painted I plate, as No. 42, but with lattice triangles meeting in concentric circles on base. Diam. 22.6. Floor.
 53. White Painted I plate, as No. 41. Diam. 20.0. Floor.
 54. White Painted I plate with flat base and two knobbed, horizontal handles. Decoration as No. 34, but with an encircled wheel inside. Diam. 20.2. Floor.
 55. White Painted I plate, as No. 33. Diam. 23.0. In No. 56.
 56. White Painted I plate of the same shape as No. 38, but with an encircled wheel inside. Diam. 21.8. Floor.
 57. White Painted I plate, as No. 34. Diam. 21.2. Floor.
 58. White Painted I plate, as No. 42. Diam. 21.7. Floor.
 59. White Painted I plate, as No. 34. Diam. 21.5. Floor.
 60. White Painted I bobbin-shaped jug with short, narrow neck, widening upwards; pinched mouth; handle from rim to shoulder. Decoration obliterated. Height 8.1. Floor.
 61. White Painted I squat jug with rounded base; short, narrow neck; swollen rim; handle from neck to shoulder. Encircling lines round rim, neck, belly; ladder-pattern on handle; concentric circles on base. Height 8.0. Floor.
 62. White Painted I deep, funnel-shaped bowl with flat base; concave sides; splaying rim; two horizontal handles below rim. Encircling lines and bands round rim, body, and base; two inverted lattice triangles below rim. Part of bowl missing. Diam. c. 18.0. Floor.
 63. White Painted I plate, as No. 34. Diam. 20.6. Floor.
 64. White Painted I plate, as No. 34, but with an encircled spiral inside. Diam. 18.2. Floor.
 65. White Painted I plate, as No. 38; concentric circles inside. Diam. 21.0. Floor.
 66. White Painted I spherical jug, as No. 17, but decorated with encircled spirals on body. Height 12.7. In No. 67.
 67. White Painted I plate, as No. 34, but with an encircled cross inside the bottom. Diam. 20.4. Floor.
 68. White Painted I plate, as No. 64. Diam. 22.0. Floor.
 69. White Painted I plate, as No. 30, but with lattice chequers on base. Diam. 23.1. Floor.
 70. White Painted I plate, shape as No. 30. Encircling lines and bands round rim and base. Inside the bottom concentric circles; on base a framed band of lattice lozenges flanked by double, filled hour-glass ornaments. Diam. 26.3. Floor.
 71. White Painted II spherical jug with narrow, concave neck; funnel-shaped mouth; handle from neck to shoulder; decoration as No. 66. Height 12.3. Floor.
 72. White Painted I plate, shape as No. 30. Encircling lines and bands round rim and base; concentric circles inside; an encircled wheel on base; transverse lines on rim. Diam. 10.2. Floor.
 73. Coarse oval jug, shape as No. 5. Neck and handle missing. Height 14.0. Floor.

The dromos burial is still later. The pottery found there is exclusively of Type III: White Painted III, Black-on-Red I (III), and Black Slip III. This specimens are very advanced in style and assign this burial to the end of Cypro-Geometric III.

TOMB 429 (Figs. 97; 98: 7-10)

	SIZE			
	Length	Width	Depth	Height
Dromos	2.00	1.60	1.50	
Stomion	0.14	1.53	—	0.80
Chamber	1.90	0.77	—	0.80

SHAPE

This tomb is of the same shape as Tomb 404. The dromos is a rectangular, wide shaft, descending to the door by three steps. The door is very wide, nearly the whole of the front of the chamber opening on to the dromos. The door was closed by a stone-packing of rough stones, extending all over the dromos; the floor of the dromos descends to that of the chamber by a vertical step. The chamber is small in size and trapezoid in shape; it narrows towards the slightly curved back wall.

STRATIFICATION

The dromos-filling consisted of homogeneous *chavara*. In the chamber there was a burial and culture stratum on the floor only covered by a thin layer of *chavara*, brought in from the dromos by rain. All the objects were found on the floor.

BURIALS

Two bodies had been buried in the tomb, both male. The remains of one skeleton belonging to the body first buried in the tomb were found in amphora No. 34, packed in there at the burial of the second body, in order to make room for it. Remains of the skeleton of this second body were found well preserved in the middle of the chamber in a dorsal, outstretched position resting on a bed of pebbles with the head towards the right wall. Both the bodies had been provided with iron knives (Nos. 12, 36), and their dresses fastened by pins of bronze (Nos. 37, 38), and of bone (No. 25). The first body had also with him a whetstone (No. 35) to sharpen his knife.

FINDS (GROUPS: PL. LVII, 1, 4; TYPES: L. OF PL. II)

1. Black Slip I oval jug with base-ring; concave neck; pinched mouth; handle from rim to shoulder. Fluted body and three horizontal, grooved lines round shoulder. Height 20.6. Floor.
2. Black Slip II oval jug, shape similar to No. 1, but with slimmer body and four to five horizontal, grooved lines round shoulder. Height 17.6. Floor.
3. Black Slip II oval jug, shape similar to No. 1, but with nearly cylindrical neck and five horizontal, grooved lines round shoulder. Height 19.1. Floor.

4. Black Slip II oval jug, as No. 3. Height 24.6. Floor.
5. Black Slip I oval jug, as No. 1, but with two horizontal, grooved lines round shoulder. Height 21.8. Floor.
6. White Painted II barrel-shaped jug with neck widening upwards; flaring rim; handle from neck to shoulder. Encircling lines and bands round rim and neck; bands of concentric circles on both sides of body; ladder-pattern on handle; a band of winged lattice lozenges in front and below handle. Height 18.2. Floor.
7. Bichrome II oval depressed jug with low foot; concave neck; splaying rim; tubular spout; basket-handle. Encircling lines and bands round rim, neck, shoulder, belly, and base; lines along spout; ladder-pattern on handle. Height 24.0. Floor.
8. Bichrome II oval jug with flat base; very short, narrow, cylindrical neck; probably pinched mouth (missing); handle from rim to shoulder. Encircling lines and bands round neck, shoulder, belly, and base; lattice triangles on shoulder; ladder-pattern on handle. Height 16.4. Floor.
9. Black Slip II oval jug, as No. 3. Height 21.0. Floor.
10. Plain White II double-conical jug with flat base, as No. 17. Neck and handle missing. Height 13.1. Floor.
11. Black Slip II oval jug, as No. 2. Handle and part of neck missing. Height 21.0. Floor.
12. Fragment of a curved iron knife. Length 7.5. Floor.
13. Bichrome II cylindrical bottle with flat base; narrow, cylindrical neck; funnel-shaped mouth; two small handles on shoulder. Encircling lines and bands round rim, neck, shoulder, body, and base. Height 17.3. Floor.
14. Black Slip II oval jug, as No. 3. Height 24.5. Floor.
15. Black Slip II depressed ovoid amphora with low foot; cylindrical, wide neck; flat rim; handles from rim to shoulder. Fluted body and four horizontal, grooved lines round shoulder. Height 18.2. Floor.
16. Black Slip II amphora, as No. 15, but with rather pyriform body. Height 13.3. Floor.
17. Plain White II jug, as No. 10 with narrow, cylindrical neck; swollen rim; handle from neck to shoulder. Height 21.0. Floor.
18. Plain White II jug, as No. 17. Height 20.0. Floor.
19. Plain White II jug, as No. 17. Height 20.3. Floor.
20. Plain White II jug, as No. 17. Height 18.2. Floor.
21. Plain White II jug, as No. 17. Height 19.2. Floor.
22. Grey Polished amphoriskos with short, stemmed foot; squat body; cylindrical neck; flat rim; handles from rim to shoulder. Height 9.0. Floor.
23. White Painted II amphoriskos, shape as No. 22, but with low foot. Encircling lines; most of decoration obliterated. Height 8.7. Floor.
24. Black Slip II oval jug, as No. 2. Height 16.5. Floor.
25. Straight pin of ivory with a head in shape of a pomegranate. Incised, encircling lines round upper part of pin. Pointed end missing. Length 6.2. Floor.
26. White Painted II oval amphora with base-ring; slightly concave neck; flaring rim; horizontal handles on shoulder. Encircling lines and bands round rim, neck, shoulder, belly, and base; framed lattice triangles on shoulder. Height 32.0. Floor.
27. Bichrome II plate with flat base and two horizontal handles. Encircling lines and bands round rim and base; on base framed lattice triangles alternate with oblique, parallel lines meeting in bichrome, concentric circles; inside decoration obliterated. Diam. 23.5. Floor.
28. Black Slip II oval jug, as No. 3. Height 27.6. Floor.
29. White Painted I depressed amphoriskos, similar to No. 23, but with concave neck, tapering upwards. Encircling lines round rim, neck, and belly; lower part of body covered with black paint; groups of transverse lines round rim; zigzag lines along handles. Height 14.8. Floor.
30. White Painted II horn-shaped vase with narrow, cylindrical neck; wide, flat rim; twin-handle from shoulder to body. Encircling lines and bands round rim, neck, and base; three friezes of lattice lozenges and framed lattice bands round body. Length 30.0. Floor.
31. Black Slip I amphoriskos with low foot; pyriform body; concave neck; flaring rim; handles from rim to shoulder. Plain. Height 15.5. Floor.
32. Black Slip II oval jug, as No. 3, but with five horizontal, grooved lines round the shoulder. Height 24.6. Floor.
33. Plain White II depressed ovoid jug with low foot; neck slightly tapering upwards; narrow, angular rim; handle from neck to shoulder. Height 16.5. Floor.
34. White Painted I depressed pyriform crater with wide, concave neck; splaying rim; handles from rim to shoulder. Encircling bands round neck and body, the rest of the decoration obliterated; lower part of body missing. Height 33.0. Floor.
35. Whetstone, flat; roughly triangular in shape; of limestone. Length 9.1. In No. 34.
36. Leaf-shaped iron knife with one cutting edge; thick back; pointed end; a flat tang, with two rivets. Length 15.0. In No. 34.
37. Fragment of a bronze pin. Length 5.5. Floor.
38. Fragment of an iron pin; slightly bent. Length 7.3. Floor.
39. Grey Polished amphoriskos, as No. 22. Foot missing. Height 5.6. Floor.

Summing up the classification given in the Object Register, we obtain the following diagram:

P o t t e r y						I r o n		Bronze	Stone	Bone	
Wh. P. I	Wh. P. II	Bichr. II	Bl. Sl. I	Bl. Sl. II	Grey Pol. Pl. Wh. II	Knife	Pin	Pin	Whetstone	Pin	
29, 34	6 23, 26 30	7, 8, 13 27	1, 5, 31	2, 3, 4 9, 11, 14 15, 16, 24 28, 32	22, 39	10, 17, 18 19, 20, 21 33	12, 36	38	37	35	25
-2	-4	-4	-3	-11	-2	-7	-2	-1	-1	-1	-1

CHRONOLOGY

The pottery, as shown by the classification, consists of a majority of Type II and a few specimens of Type I: White Painted I—II, Bichrome II, Black Slip I—II, Grey Polished, and Plain White II. This combination of pottery types assigns the tomb to the later part of Cypro-Geometric II.

SUMMARY

The Chronology of the tombs has shown that they date from three main periods: Cypro-Geometric I, Cypro-Geometric II, and Cypro-Geometric III. The classification of the finds, however, has admitted of a more definite chronological division of the burial groups and we can assign each burial group to an early or late stage within each period. If we call these stages A and B, we obtain the following chronological division of the tombs.

Cypro-Geometric I A: Tombs 406, 414, 417, 420, 422 — 5 burial groups.

Cypro-Geometric I B: Tombs 407, 410, 412, 419, 428^I — 5 burial groups.

Cypro-Geometric II A: Tombs 408, 409, 413, 415, 418, 425^{I-II} — 7 burial groups.

Cypro-Geometric II B: Tombs 401^I, 408 (niche), 411, 416, 423, 424, 426, 429 — 8 burial groups.

Cypro-Geometric III A: Tombs 401^{II}, 402, 403^{I-III}, 404, 428^{II}, — 7 burial groups.

Cypro-Geometric III B: Tombs 405, 407 (dromes), 410 (niche), 421, 422^{II}, 427, 428 (dromos) — 7 burial groups.

Thus the number of burial groups are fairly equally distributed among the different periods, with a slight predominance in Cypro-Geometric II. But if we consider the quality of the finds and their wealth within them, we obtain another picture. From the very beginning of Cypro-Geometric I there was developed a vigorous and grand culture; this lasted, though declining, into Cypro-Geometric II, and came to an end in Cypro-Geometric III A. In Cypro-Geometric III B the standard of culture is quite different; the tombs are poor in finds and, very often, earlier tombs are used as burial places, indicating stagnation and pauperisation of civilization. In view of this fact it seems symptomatic that no tombs later than Cypro-Geometric III B were found: probably the settlement of which this was the necropolis, ceased to exist at the end of this period, although, of course, it is possible that only another burial ground had been chosen.

It is not possible to discover any local grouping of the tombs of each period: tombs of all the periods occur side by side everywhere within the area of the necropolis excavated by us; the tombs are placed very close to each other; so that sometimes the rock wall separating them has collapsed. The shape of the tombs differs. We have seen that three types are represented. The tomb with a long dromos of the passage type, with walls converging upwards; the tomb with a shorter dromos of the passage type, with nearly straight walls; and the tomb with a dromos of the shaft type. The first type prevails in Cypro-Geometric I; the second type is characteristic of Cypro-Geometric II and Cypro-Geometric III A. The third type occurs for the first time at the end of Cypro-Geometric II (Tomb 429) and is characteristic of Cypro-Geometric III.

The tombs were often used for repeated but successive burials, indicating that they were family tombs. Fresh burials, without any connection with the earlier burials in the tomb, occur sporadically at the end of Cypro-Geometric III A (Tomb 408¹) and is the rule in Cypro-Geometric III B.

The corpses were all inhumated and, as a rule, placed in an outstretched, dorsal position on the rock floor or levelled beds of clay and earth. Occasionally, the corpses were placed on their right or left side, in a slightly contracted position (Tombs 402, 405, 428, dromos) and there is a single instance of the interment of a child placed in a bowl in a sitting position (Tomb 420, niche). No traces of coffins were found. The deceased were dressed in clothes fastened with pins and fibulae. Tomb-gifts in pots of various kinds were heaped around the corpses; the men provided with the instruments used in their daily life: knives, pikes, shepherd's crook etc.; the women retained their spindle-whirls as a token of their practical home-work, and the majority of their jewellery which, in cases of wealth, was of exquisite quality: finger-rings and earrings of gold, pendants and necklaces of gold, gold plaques with figural representations, used as ornaments of the head-gear; circular, ornamented gold plaques, probably fastened to the dress, etc. In some cases, there are single specimens of rings which cannot have been finger-rings (Tombs 406, 425); it has been suggested that these were nose-rings (for the existence of such see Ohnefalsch-Richter, *Kypros, die Bibel und Homer*, pl. LV, 1—7).

But these tomb-gifts were not the only offerings made to the dead. There is evidence that even human sacrifices were performed to them, probably slaves, killed at the funeral (Tombs 412, 417, 420).

E. G.

The Necropolis at Plakes

INTRODUCTION

The topography of the site has already been described, p. 13, in connection with the publication of the excavations of the Neolithic settlement situated there: these excavations show that the tombs of the necropolis are cut in the rock upon which the remains of the



Fig. 101. Lapithos. Tomb 601, dromos.

Fig. 102. Lapithos. Tomb 602. Upper part of Skeleton III with tomb-gifts *in situ*.

Neolithic settlement were accumulated. Of the tombs, we excavated only those which were situated within the examined area of the Neolithic settlement. These tombs are described below and are numbered 601—603.

TOMB 601 (Figs 98: 11—15; 101; 105: 1)

SIZE

	Length	Width	Depth	Height
Dromos	2.32	1.05	2.00	—
Stomion	0.25	2.02	—	1.33
Chamber	2.40	1.20	—	c. 1.20

SHAPE

This tomb is of similar shape to Tombs 404 and 429.

The dromos is a deep shaft, trapezoid in plan with vertical walls and horizontal floor. Along the long front side, 0.30 m. from the bottom, a step is cut in the rock. The shaft opens on to the chamber through a rectangular, wide stomion, occupying nearly the whole width of the dromos and the chamber. The door was closed by a stone-packing of rubble, and the floor of the dromos descends gradually to that of the chamber. The chamber is niche-shaped, roughly rectangular with rounded corners and curved side walls. The floor slopes towards the middle of the chamber and the roof has collapsed.

STRATIFICATION

The lower part of the dromos was filled with three layers of *chavara* of different degrees of hardness. On the top of these, there was an accumulation of rubble and earth partly rising above the rock surface, as a sort of a tumulus. These stones had been taken from the walls of the Neolithic settlement and Neolithic potsherds were found in the filling between the stones (cf. above p. 14).

The layers in the chamber were composed of:

- 1) A layer of *chavara* brought in from the dromos, and rock from the collapsed roof.
- 2) A burial and culture stratum covered by infiltrated, silted clay.
- 3) Another burial and culture stratum on the floor.

The following objects belong, according to their level, to the first burial period: Nos. 1, 2, 9, 18, 19; and the following, to the second burial period: Nos. 3—8, 10—17.

BURIALS

At the time of the second burial period the burial remains of the first burial stratum were swept away towards the right side of the chamber, where the skull and other fragments of Skeleton No. I were found. In the second burial stratum remains of two skeletons were found. Of these, Skeleton No. II had been swept away towards the right wall, in order to make room for the last burial, the remains of which are represented by Skeleton No. III. This was found along the back wall of the chamber with the femora, tibiae and fibulae, in an outstretched position with the legs crossed. The other skeletal remains: the skull, and parts of the upper extremities were not found *in situ*, (the lower jaw was found among the bones of the upper extremities and the other part of the skull at the upper end of the femora). From the position of the lower extremities it is, however, evident that the body had been placed in a dorsal, outstretched position with the legs crossed and the head towards the left wall. The dress of this body had been fastened by a bronze pin (No. 4); the second body was provided with an iron knife (No. 13).

FINDS (GROUPS: PL. LVIII, 1, 3; TYPES: L. OF PL. II)

- | | |
|--|--|
| <ol style="list-style-type: none"> 1. Black Slip II oval jug with base-ring; slightly concave neck; pinched mouth; handle from rim to shoulder. Fluted body and five horizontal, grooved lines round shoulder. Height 22.5. First burial stratum. 2. Black Slip I oval jug with base-ring; short, concave neck, widening upwards; pinched mouth; handle from rim to shoulder. Fluted body and three horizontal, grooved lines round shoulder. Height 21.3. First burial stratum. 3. Bichrome I—II plate with flat base and two horizontal, knobbed handles below rim. Encircling lines and bands round rim and base; an encircled spiral inside; four framed lattice triangles meeting in bichrome, concentric circles on base. Decoration faded. Diam. 31.4. Second burial stratum. 4. Bronze needle with flat head and eyelet. Broken; part of eyelet missing. Length 12.5. Second burial stratum. | <ol style="list-style-type: none"> 5. Bichrome II barrel-shaped jug with narrow, concave neck; funnel-shaped mouth; handle from neck to shoulder. Encircling lines and bands round rim and neck; ladder-pattern on handle; bands of concentric circles on both sides of body. Height 11.5. Second burial stratum. 6. White Painted I—II plate with flat base, and two horizontal, knobbed handles below rim. Encircling lines and bands round rim and base; concentric circles inside; four lattice triangles meeting in concentric circles on base. Diam. 22.3. Second burial stratum. 7. White Painted I—II plate, as No. 6, but with plain handles and two filled, framed, inverted triangles opposite each other between rim and base; encircling lines and bands around base. Diam. 23.9. Second burial stratum. 8. Bichrome II plate with wide base-ring and two knobbed |
|--|--|

L A P I T H O S

- handles below rim. Encircling lines and bands round rim and base; concentric circles inside; on base three framed lattice triangles alternating with parallel, oblique lines meeting in bichrome, concentric circles. Diam. 25.6. Second burial stratum.
9. White Painted I plate, shape as No. 7, but with narrower base. Decoration as No. 6, but four lattice triangles meeting in a circle on base. Diam. 21.3. First burial stratum.
 10. Bichrome II pilgrim-bottle with slightly concave, narrow neck; funnel-shaped mouth; two handles from neck to shoulder. Encircling lines round mouth; ladder-pattern on handles; bands of concentric circles on both sides of body. Height 13.0. Second burial stratum.
 11. Black Slip II oval jug, as No. 2, but with four horizontal, grooved lines round the shoulder. Height 24.9. Second burial stratum.
 12. White Painted I plate, shape as No. 9. Encircling lines and bands round rim and base; an encircled spiral inside; framed band of lattice lozenges flanked by two lattice triangles on base. Diam. 31.4. Second burial stratum.
 13. Iron knife with curved blade, one cutting edge, pointed end and flat tang. Traces of wood still visible on tang. Length 13.5. Second burial stratum.
 14. White Painted I plate, shape as No. 9. Encircling lines and bands round rim and base; concentric circles inside; two latticed and two filled triangles forming a secondary cross on base. Diam. 32.0. Second burial stratum.
 15. Black Slip II oval jug, as No. 11. Height 24.5. Second burial stratum.
 16. White Painted I open bowl with low foot; softly curved outline; two horizontal handles below rim. Encircling bands outside and inside rim, around body and base. Diam. 10.0. Second burial stratum.
 17. White Painted I—II depressed ovoid amphora with low foot; wide, short, slightly concave neck; swollen rim; horizontal handles on shoulder. Encircling lines and bands round neck and base; transverse lines on rim and handles. Height 46.1. Second burial stratum.
 18. White Painted I pyriform amphoriskos with base-ring; short, wide, concave neck; flaring rim; two horizontal handles on shoulder. Encircling bands round rim, neck, shoulder, belly, and base; lattice triangles on shoulder. Height 10.2. First burial stratum.
 19. White Painted I spherical jug with narrow, short neck; collar-shaped mouth; handle from neck to shoulder. Encircling lines round rim and neck; ladder-pattern on handle; four encircled spirals on body. Height 9.0. First burial stratum.

Summing up the classification given in the Object Register and the stratigraphical data, we obtain the following diagram:

	P o t t e r y						Iron	Bronze
	Wh. P. I	Wh. P. I-II	Bichr. I-II	Bichr. II	Bl. Sl. I	Bl. Sl. II	Knife	Needle
1st burial period	9. 18. 19 -3				2 -1	1 -1		
2nd burial period	12. 14. 16 -3	6. 7. 17 -3	3 -1	5, 8. 10 -3		11. 15 -2	13 -1	4 -1

C H R O N O L O G Y

The first burial period dates from the end of Cypro-Geometric I, as the pottery found in the first burial stratum consists of a majority of Type I: White Painted I and Black Slip I, and a single specimen of Black Slip II ware.

In the second burial stratum, the pottery is both of Types I and II with a preponderance of Type I: White Painted I—II, Bichrome I—II, and Black Slip II. This combination of pottery types assigns the second burial period to the early part of Cypro-Geometric II.



Fig. 103. Lapithos, Tomb 602. Upper part of Skeleton I with tomb-gifts *in situ*.



Fig. 104. Lapithos, Tomb 603, dromos.

TOMB 602 (Figs. 102; 103; 105: 2—6)

SIZE

	Length	Width	Depth	Height
Dromos	2.15	1.20	1.80	—
Stomion	0.15	1.72	—	1.13
Chamber	2.10	1.15	—	c. 1.10

SHAPE

This tomb is of the same shape as Tomb 601. The dromos is not provided with a rock-cut step. The chamber is trapezoid in plan, with oblique left and back walls. The floor is approximately horizontal and the roof has collapsed.

STRATIFICATION

The stratification both of the dromos and of the chamber shows an identical composition with that of Tomb 601. In the top of the *chavara* filling in the dromos, there was also a tumulus of earth and stones rising above the rock surface, and in the chamber, on the bottom layer of burial and culture earth, there was another burial and culture stratum mixed with silted clay, and covered with rock from the fallen roof. The following objects belong to the first burial stratum: 6, 9, 10, 26, 27, 33—41, 43, 46—52, 56, 57, 88—103; and the following to the second burial stratum 1—5, 7, 8, 11—25, 28—32, 42, 44, 45, 53—55, 58—87.

BURIALS

Remains of three skeletons were left, one in the first burial stratum and two in the second. Of these Skeleton No. I, in the first burial stratum, was in a perfect state of preservation. It was found in a dorsal, outstretched position along the back wall of the chamber

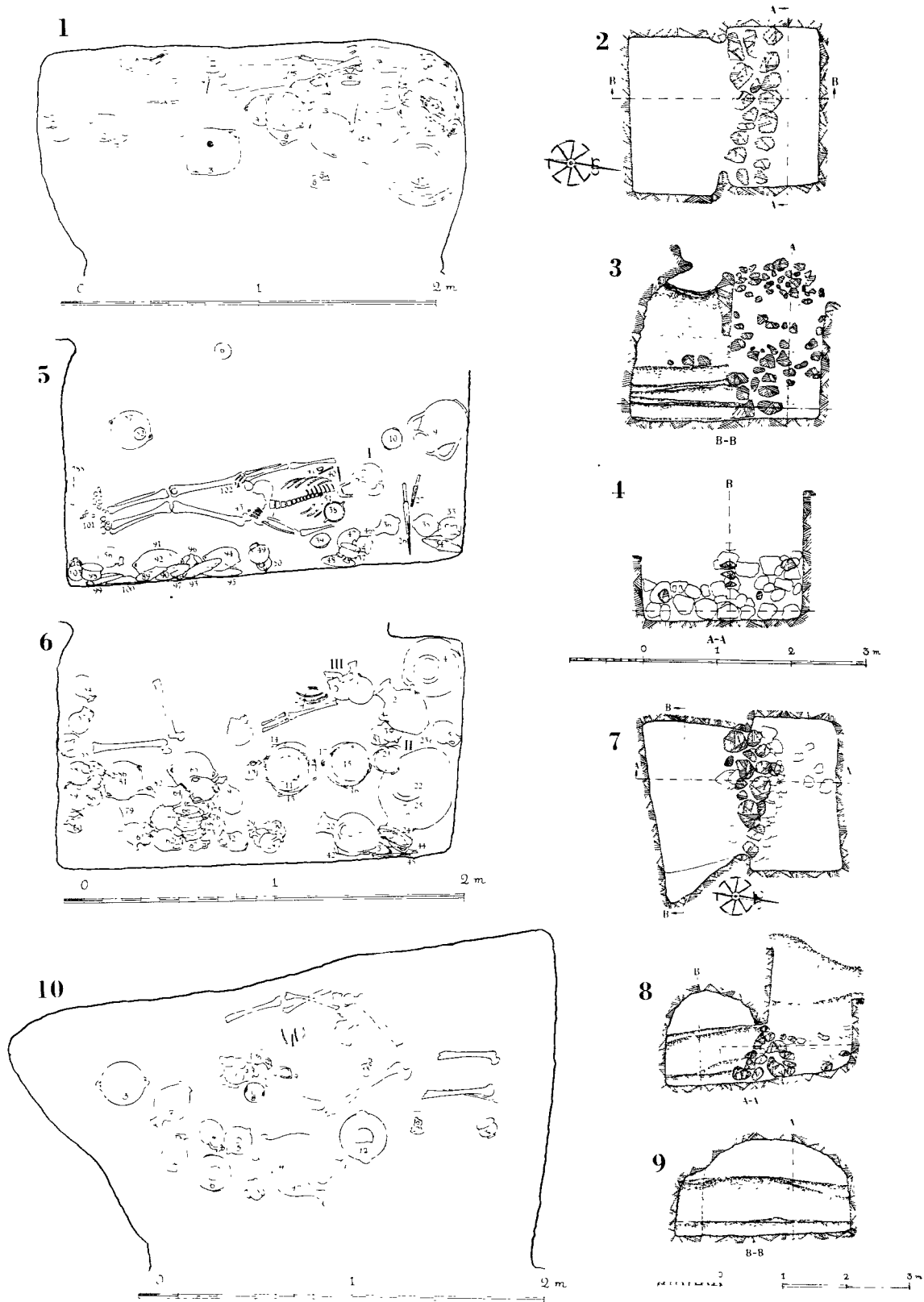

Fig. 105. Lapithos. Tomb 601, Finds *in situ* (1). Tomb 602, Plan (2); Sections B-B, A-A (3, 4); Finds *in situ*: 1st burial period (5) and 2nd burial period (6). Tomb 603, Plan (7); Sections A-A, B-B (8, 9); Finds *in situ* (10).

with the head towards the left wall. The body was male, had finger-rings on both its hands (Nos. 43 and 102) and toe-rings on its toes (No. 101). Further, he was provided with an iron knife (No. 27) and a spear with a preserved spear-head of bronze (No. 26). His dress had been fastened with a bronze pin (No. 40) and two bronze fibulae (Nos. 41 and 51). Skeleton No. II, in the second burial stratum, had been moved in order to make room for the last burial: the skull was found close to amphora No. 22, and some of the bones had been packed into it. The body had been adorned with a finger-ring of bronze (No. 23). The skeletal remains of the last body buried in the chamber (Skeleton No. III) were found along the front wall. The body was placed in a dorsal, outstretched position with the head towards the left wall, which could be seen from the only partially disturbed position of the preserved bones: the skull, left humerus, cubital bone, fibula, parts of the ribs, pelvis, and the femora. The dress of the deceased had been fastened with a pin of bronze (No. 7).

FINDS (GROUPS: PL. LIX; TYPES: L. OF PL. II)

1. Bichrome II spherical jug with narrow, concave neck; handle-ridge; flaring rim; twin-handle from neck to shoulder. Encircling lines and bands round rim and neck; concentric circles on both sides of body; bands of winged lattice lozenges below and opposite handle; ladder-pattern on handle. Height 22.7. Second burial stratum.
2. White Painted II oval amphora with base-ring; slightly concave, splaying rim; two horizontal handles on shoulder. Encircling lines and bands round rim, neck, shoulder, belly, and base; transverse lines on rim; lattice triangles on shoulder. Height 32.3. Second burial stratum.
3. White Painted I askos with low foot; cylindrical body; convex top with central knob; a goat's protome with long, curved horns; short, cylindrical spout; twin basket-handle with a loop on top. Encircling lines round protome, spout, body, and base; a frieze of lattice lozenges round belly; ladder-pattern on top; elaborate pattern of framed, arc-shaped, hatched bands with inverted, filled triangles between; some lattice triangles below arc. Height 19.5. Second burial stratum.
4. White Painted II oval amphora, as No. 2, but with a ridge around base of neck. Height 43.0. Second burial stratum.
5. Black Slip I ovoid jug with base-ring; concave neck; pinched mouth; handle from rim to shoulder. Fluted body and three horizontal, grooved lines round shoulder. Height 16.7. Second burial stratum.
6. White Painted I spherical jug with short, narrow, concave neck; collar-shaped mouth; handle from neck to shoulder. Encircling lines round rim and neck; ladder-pattern on handle; four groups of concentric circles on body. Height 11.5. First burial stratum.
7. Fragment of straight bronze pin. Length 8.9. Second burial stratum.
8. White Painted I depressed ovoid jug with base-ring; short, concave neck; pinched mouth; handle from rim to shoulder; the lower part of body covered with black paint; lattice triangles on shoulder. Height 16.3. Second burial stratum.
9. White Painted I pyriform amphora with low, wide foot; wide, concave neck; splaying rim; handles from rim to shoulder. Encircling bands round shoulder, belly, and foot; around neck metope decoration of filled, framed hour-glass ornaments and framed, winged lattice lozenges flanked by parallel lines. Height 35.0. First burial stratum.
10. White Painted I open bowl with low foot; softly curved outline; two horizontal handles below rim. Encircling bands round rim and base. Diam. 11.0. First burial stratum.
11. White Painted I plate with flat base and two horizontal handles below rim. Encircling lines and bands round rim and base; a pseudo-spiral inside; four lattice triangles meeting in a circle on base. Diam. 23.0. Second burial stratum.
12. Bichrome II plate with wide base-ring and two horizontal, knobbed handles below rim. Encircling lines and bands round rim and base; an encircled dot inside; three framed lattice triangles meeting in bichrome, concentric circles on base. Diam. 25.8. Second burial stratum.
13. White Painted I plate with narrow base-ring and two horizontal handles below rim. Encircling lines and bands round rim and base; an encircled wheel inside; four lattice triangles forming a secondary cross with a central lattice square on base; transverse strokes on base-ring. Diam. 19.6. Second burial stratum.
14. White Painted I plate, as No. 11, but with concentric circles inside. Diam. 20.3. Second burial stratum.
15. White Painted I plate, as No. 11, but with a framed band of lattice lozenges flanked by two lattice lozenges on base. Diam. 20.0. Second burial stratum.

16. White Painted I plate, as No. 14. Diam. 21.4. Second burial stratum.
17. White Painted I plate, as No. 11. Diam. 23.4. Second burial stratum.
18. White Painted I spherical jug, as No. 6, but with a group of concentric circles on both sides of body. Height 11.8. Second burial stratum.
19. Black Slip II oval jug, similar to No. 5, but with short, nearly cylindrical neck and four horizontal, grooved lines round the shoulder. Height 18.2. Second burial stratum.
20. White Painted II amphora, as No. 2. Height 31.2. Second burial stratum.
21. Black Slip I globular jug with low foot; concave neck; pinched mouth; handle from rim to shoulder. Fluted body and five horizontal, grooved lines round base of neck. Part of neck and handle missing. Height 17.2. Second burial stratum.
22. White Painted I amphora with base-ring; short, concave neck; swollen, flaring rim; horizontal handles on shoulder. Groups of encircling bands round body, shoulder, and neck; two encircling, wavy lines below shoulder. Height 51.0. Second burial stratum.
23. Fragment of a flat finger-ring of bronze. Diam. 2.0. Second burial stratum.
24. Black Slip I pyriform amphoriskos with low foot; wide, concave neck; flat rim; handles from rim to shoulder. Fluted body. Height 14.3. Second burial stratum.
25. Black Slip I oval jug, as No. 5. Height 15.0. Second burial stratum.
26. Long, leaf-shaped spear-head of bronze with midrib and socket, retaining a slit along one side. End of socket missing. Length 37.7. First burial stratum.
27. Curved iron knife with one cutting edge; flat, wide tang with three rivets. Point missing. Scanty remains of wooden handle still traceable. Length 17.0. First burial stratum.
28. Black Slip II oval jug, similar to No. 19, but with rather depressed body and three grooved lines round shoulder. Height 14.7. Second burial stratum.
29. Black Slip II oval jug, as No. 28. Height 13.5. Second burial stratum.
30. Black Slip II oval jug, as No. 28, but with two horizontal, grooved lines round shoulder. Height 15.0. Second burial stratum.
31. White Painted I plate, as No. 14, but with four lattice triangles meeting in concentric circles on base. Diam. 24.5. Second burial stratum.
32. Black Slip II oval jug, as No. 28. Height 14.8. Second burial stratum.
33. Black Slip I oval jug, as No. 5. Height 16.0. First burial stratum.
34. White Painted I—II plate, similar to No. 14, but with three framed lattice triangles meeting in an encircled dot on base. Diam. 21.4. First burial stratum.
35. Plain White I oval jug with base-ring and handle from neck to shoulder. Mouth missing. Height 15.4. First burial stratum.
36. Black Slip I oval jug, as No. 21, but with no horizontal, grooved lines round the shoulder. Damaged. Height 14.7. First burial stratum.
37. White Painted I bowl, as No. 10. Diam. 10.9. First burial stratum.
38. Black Slip I amphoriskos, as No. 24. Height 10.6. First burial stratum.
39. White Painted I shallow bowl with base-ring; convex sides; two horizontal handles below rim. Encircling lines round rim and base; an encircled spiral inside; an encircled maltese cross on base; two inverted, framed lattice triangles from rim to base on opposite sides of body. Diam. 10.0. First burial stratum.
40. Straight pin of ivory with pointed end and thickening head. Two incised, framed, latticed bands round head. Point missing. Length 9.1. First burial stratum.
41. Bronze fibula with thick, angular, beaded bow; single-coiled spring; small, flat catch; straight pin. Length 3.5. First burial stratum.
42. Black Slip I oval jug, as No. 5. Height 18.8. Second burial stratum.
43. Finger-ring of bronze; flat, with overlapping ends. Broken. Diam. 2.0. First burial stratum.
44. White Painted I plate, as No. 31. Diam. 23.0. Second burial stratum.
45. Bichrome II plate, as No. 12. Diam. 20.0. Second burial stratum.
46. White Painted I depressed pyriform amphoriskos with low foot; wide, concave neck; flat rim; handles from rim to shoulder. Encircling lines and bands round rim and neck; groups of short strokes pendant from base of neck; transverse lines on rim; ladder-pattern on handles. Height 12.0. First burial stratum.
47. Black Slip I oval jug, as No. 5. Height 16.8. First burial stratum.
48. White Painted I plate, as No. 15, but with concentric circles inside. Diam. 18.0. First burial stratum.
49. Plain White I oval jug with base-ring; slightly concave neck; handle from neck to shoulder. Height 16.0. First burial stratum.
50. White Painted I depressed oval jug with low foot; concave neck; tubular spout on shoulder; basket-handle (missing). Encircling lines round rim, neck, and belly; lattice triangles on shoulder; longitudinal and encircling lines on spout; lower part of body covered with black paint. Height 14.5. First burial stratum.
51. Fragment of the pin of a bronze fibula. Length 3.0. First burial stratum.
52. White Painted I squat jug with round base; narrow, slightly concave neck; swollen rim; handle from neck to shoulder. Encircling lines round rim and belly; concentric circles on base; ladder-pattern on handle. Height 5.8. First burial stratum.

53. Plain White I jug, as No. 49. Height 14.5. Second burial stratum.
54. Black Slip I oval jug, as No. 5. Height 14.5. Second burial stratum.
55. White Painted II oval jug with base-ring; nearly cylindrical neck; pinched mouth, handle from neck to shoulder. Encircling lines and bands round rim, neck, and shoulder; lattice triangles on shoulder; lower part of body covered with black paint. Height 17.0. Second burial stratum.
56. Plain White I oval jug, as No. 49. Height 13.0. First burial stratum.
57. White Painted I plate, shape as No. 12. Encircling lines and bands round rim and base; concentric circles inside; chequers on base. Decoration nearly effaced. Diam. 20.5. First burial stratum.
58. Plain White I oval jug, as No. 49. Height 14.7. Second burial stratum.
59. Plain White I oval jug, as No. 49. Height 15.2. Second burial stratum.
60. Black Slip II oval jug, as No. 28. Height 15.4. Second burial stratum.
61. White Painted I jug, shape as No. 50, but with wider neck. Encircling lines and bands round neck, belly, and base; a wavy line along handle; longitudinal and encircling lines on spout. Height 18.7. Second burial stratum.
62. Black Slip I oval jug, as No. 5. Height 16.8. Second burial stratum.
63. White Painted I amphoriskos, shape as No. 46. Encircling lines and bands round rim, neck, and belly; lower part of body covered with black paint; transverse lines on rim; ladder-pattern on handles. Height 13.9. Second burial stratum.
64. Plain White I oval jug, as No. 49. Height 14.7. Second burial stratum.
65. White Painted I plate with flat base and two knobbed, horizontal handles. Encircling lines and bands round rim and base; concentric circles inside; band of framed lattice lozenges flanked by four triangles on base. Decoration much worn. Diam. 21.7. Second burial stratum.
66. White Painted I plate, as No. 11. Diam. 14.0. Second burial stratum.
67. White Painted I plate, as No. 11. Diam. 12.4. Second burial stratum.
68. White Painted I plate, as No. 11. Diam. 12.7. Second burial stratum.
69. White Painted I plate, as No. 11. Diam. 14.0. Second burial stratum.
70. White Painted I plate, as No. 11. Diam. 13.4. Second burial stratum.
71. White Painted I plate, shape as No. 65, and decoration as No. 11. Diam. 12.7. Second burial stratum.
72. White Painted I plate, as No. 71, but with concentric circles inside. Diam. 13.5. Second burial stratum.
73. White Painted I plate, shape as No. 11, and decoration as No. 72. Diam. 14.2. Second burial stratum.
74. White Painted I plate, as No. 72. Diam. 12.2. Second burial stratum.
75. White Painted I plate, as No. 72. Diam. 12.9. Second burial stratum.
76. White Painted I plate, as No. 11, but the triangles on base meet in a central dot. Diam. 14.0. Second burial stratum.
77. White Painted I plate, as No. 72. Diam. 13.5. Second burial stratum.
78. White Painted I plate, as No. 72. Decoration nearly obliterated. Diam. 13.8. Second burial stratum.
79. White Painted I plate, as No. 11, but with four framed, lattice triangles meeting in a wheel-ornament on base. Diam. 21.3. Second burial stratum.
80. White Painted I—II plate, as No. 34. Diam. 18.5. Second burial stratum.
81. White Painted I plate, shape as No. 11. Encircling lines and bands; an encircled dot inside; on base a large, framed lattice square with filled triangles in the angles. Diam. 20.4. Second burial stratum.
82. White Painted I bowl, shape as No. 39. Encircling lines round rim and base; concentric circles inside; filled maltese cross on base. Diam. 9.4. Second burial stratum.
83. White Painted I bowl, as No. 39. Diam. 9.4. Second burial stratum.
84. White Painted I bowl, as No. 39. Diam. 9.3. Second burial stratum.
85. White Painted I bowl, as No. 39, but with concentric circles inside. Diam. 9.5. Second burial stratum.
86. White Painted I bowl, as No. 85. Diam. 9.3. Second burial stratum.
87. White Painted II spherical jug with short, narrow neck; funnel-shaped mouth; handle from neck to shoulder. Encircling lines round rim and neck; ladder-pattern on handle; four groups of concentric circles on body; encircled maltese cross on base. Height 12.5. Second burial stratum.
88. White Painted I plate, as No. 11. Diam. 20.7. First burial stratum.
89. White Painted I plate, shape as No. 65. Encircling lines and bands round rim and base; an encircled wheel inside; six lattice triangles meeting in a central dot on base. Diam. 16.7. First burial stratum.
90. White Painted I plate, as No. 11, but with four lattice triangles meeting in an encircled spiral on base. Diam. 19.2. First burial stratum.
91. White Painted I plate, as No. 31. Diam. 24.0. First burial stratum.
92. Black Slip Painted I plate with flat base and two horizontal handles below rim. Concentric circles inside; a band of lattice lozenges flanked by two framed lattice triangles on base. Black-painted and fluted sides. Diam. 20.0. First burial stratum.
93. White Painted I plate, as No. 15, but with an encircled wheel inside. Diam. 21.5. First burial stratum.
94. White Painted I plate, as No. 81. Diam. 17.5. First burial stratum.

- 95. White Painted I plate, as No. 11, but with four lattice triangles meeting in concentric circles on base. Diam. 24.5. First burial stratum.
- 96. Black Slip I oval jug, as No. 21. Diam. 9.2. First burial stratum.
- 97. White Painted I bowl, as No. 85, but decoration obliterated inside. Diam. 9.2. First burial stratum.
- 98. White Painted I bowl, as No. 10. Diam. 12.0. First burial stratum.
- 99. White Painted I plate, as No. 15. Diam. 19.1. First burial stratum.
- 100. White Painted I plate, shape as No. 15. On base a framed band of lattice triangles and lozenges with two knobbed semicircles at short sides and flanked by two lattice triangles. Diam. 22.0. First burial stratum.
- 101. Three toe-rings of bronze, shape as No. 43, and fragments of two similar ones. Diam. 1.7. First burial stratum.
- 102. Fragments of a finger-ring of bronze. First burial stratum.
- 103. White Painted I pilgrim-bottle with short, narrow, concave neck; two handles from neck to shoulder. Encircled wheels and concentric circles on both sides of body; ladder-pattern on handle. Mouth missing. Height 11.9. First burial stratum.

Summing up the classification given in the Object Register and the stratigraphical data, we obtain the following diagram:

	Pottery							Iron	Bronze				Bone		
	Wh. P. I	Wh. P. I-II	Wh. P. II	Bichr. II	Bl. Sl. P. I	Bl. Sl. I	Bl. Sl. II	Pl. Wh. I	Knife	Spear-head	Pin	Fibula	Finger-ring	Toe-ring	Pin
1st burial period	6, 9, 10, 37, 39, 46 48, 50, 52, 57, 88, 89 90, 91, 93, 94, 95, 97 98, 99, 100, 103 -22	34			92	33, 36, 38, 47 96		35 49 56	27	26		41 51	43 102	101	40
		-1			-1	-5		-3	-1	-1		-2	-2	-1	-1
2nd burial period	3, 8, 11, 13, 14, 15, 16 17, 18, 22, 31, 44, 61, 63 65, 66, 67, 68, 69, 70, 71 72, 73, 74, 75, 76, 77, 78 79, 81, 82, 83, 84, 85, 86 -35	80	2	1		5, 21 24, 25 42, 54 62	19, 28 29, 30 32, 60	53 58 59 64			7		23		
		-1	-5	-3		-7	-6	-4			-1		-1		

CHRONOLOGY

We thus see that the first burial stratum contained pottery almost exclusively of Type I: White Painted I, Black Slip Painted I, Black Slip I, and Plain White I, and a single specimen of White Painted I—II. Some of the specimens of Type I are advanced in style and indicate that the first burial period dates from the later part of Cypro-Geometric I.

In the second burial stratum there was a majority of Type I, and a number of Type II: White Painted I—II, Bichrome II, Black Slip I—II, and Plain White I. The second burial period is, therefore, assigned to the early part of Cypro-Geometric II.

TOMB 603 (Figs. 104; 105: 7—10)

SIZE

	Length	Width	Depth	Height
Dromos	2.43	1.45	2.10	—
Stomion	—	1.95	—	0.90
Chamber	2.88	1.73	—	c. 0.90

SHAPE

This tomb is of similar shape to Tomb 602. The chamber is an irregular trapezoid in plan, with oblique back wall, and the side walls widening towards the back. The floor slopes slightly towards the back, and the roof has collapsed.

STRATIFICATION

The dromos was filled with a homogeneous *chavara* mixed with a few loose stones, but was not covered by a stone tumulus as in the dromoi of Tombs 601 and 602. The layers in the chamber consisted of a bottom layer of burial and culture earth; a second, thin layer of dromos-filling mixed with sand, infiltrated from the dromos; a third, thick layer of rock, and a fourth and top layer of silted clay. There was, consequently, only one burial period and all the finds were found on the floor or in the burial earth.

BURIALS

In the burial layer there were remains of a single body: the skull and most of the bones are fairly well preserved in the back of the chamber but not *in situ*. The dress of the deceased had been fastened with a fibula of bronze (No. 9), and the tomb-gifts in pots, were placed in a semicircular row in front of him.

FINDS (GROUPS: PL. LVIII, 2, 4; TYPES: L. OF PL. II)

1. White Painted I open bowl with low foot; softly curved outline; two horizontal handles below rim. Encircling bands round rim, body, and base. Diam. 10.0. Floor.
2. Black Slip I oval jug with low foot; concave neck, slightly tapering upwards; pinched mouth; handle from rim to shoulder. Fluted body and three horizontal, grooved lines round the shoulder. Height 19.0. Floor.
3. White Painted I plate with flat base and two horizontal handles below rim. Encircling lines and bands round rim and base; concentric circles inside; a band of lattice lozenges flanked by two lattice triangles on base. Diam. 22.5. Floor.
4. White Painted I depressed oval jug with low foot; concave neck; pinched mouth; handle from rim to shoulder. Encircling lines and bands round rim, neck, and belly; a zigzag line on handle; lattice triangles on shoulder; lower part of body covered with black paint. Height 15.0. Floor.
5. White Painted I deep, conical bowl with narrow base-ring; convex sides; handles from rim to body. A hatched band around rim; concentric circles inside. Diam. 15.0. Floor.
6. White Painted I bowl, as No. 1. Diam. 18.6. Floor.
7. White Painted I oval jug with base-ring; short, concave neck; pinched mouth; handle from rim to shoulder. Encircling lines and bands round rim, neck, shoulder, belly, and base; a framed band on handle; lattice triangles on shoulder; vertical, hatched band in front. Height 25.0. Floor.
8. White Painted I bowl, as No. 1. Diam. 10.2. Floor.
9. Bronze fibula with angular, beaded bow; flat fore-end; single-coiled spring; straight pin. Catch and point of pin missing. Length 5.5. Floor.
10. White Painted I pyriform amphora with wide, concave neck; splaying rim; handles from rim to shoulder. Encircling bands round rim, neck, and base; groups of short strokes pendant from base of neck. Height 43.0. Floor.
11. White Painted I bowl, as No. 1. Diam. 10.1. Floor.
12. White Painted I bowl, shape as No. 1. Encircling bands round rim, body, and base. Metope decoration of a framed lozenge filled with chequered squares and flanked by bands of parallel lines and winged lattice lozenges. Diam. 24.1. Floor.
13. White Painted I depressed spherical jug with narrow neck; collar-shaped mouth; handle from neck to shoulder. Encircling lines and bands round rim, neck, belly, and base; ladder-pattern on handle; lattice triangles on shoulder. Height 10.0. Floor.
14. White Painted I bowl, as No. 1. Diam. 10.5. Floor.
15. White Painted I oval jug, as No. 4, but with ladder-pattern on handle. Height 15.5. Floor.
16. White Painted I spherical jug, similar to No. 13. Encircling lines and bands round rim and neck; ladder-pattern on handle; encircled spirals on body. Height 12.4. Floor.

Summing up the classification given in the Object Register, we obtain the following diagram:

P o t t e r y								B r o n z e	
W h. P. I								Bl. Sl. I	Fibula
1.	3.	4.	5.	6.	7.	8.		2	9
10.	11.	12.	13.	14.	15.	16.		-1	-1
			-14						

CHRONOLOGY

The pottery is entirely of early Type I: White Painted I and Black Slip I, assigning to the tomb a date in the early part of Cypro-Geometric I.

SUMMARY

The chronology of the tombs has shown that they date from two periods: Cypro-Geometric I and Cypro-Geometric II. Summing up the evidence as to date, we obtain the following chronological division of the different burial groups.

Cypro-Geometric I A: Tomb 603 — 1 burial group.

Cypro-Geometric I B: Tombs 601^I, 602^I — 2 burial groups.

Cypro-Geometric II A: Tombs 601^{II}, 602^{II} — 2 burial groups.

The tombs are all of the third type represented at Kastros, i. e. the dromos is of the shaft-type. There is evidence that the tombs were covered with a mound of earth and stones. The bodies were all placed in an outstretched, dorsal position, often with crossed legs; in other respects, too, the burials were similar to those of the tombs at Kastros. The toe-rings which adorned the toes of a body in Tomb 602 are noteworthy.

E. G.

K Y T H R E A

Neolithic settlement

TOPOGRAPHY

The finding of some implements of stone and flint from the village of Kythrea was reported to us during the winter of 1930. The site where the objects were found is situated to the east of the new school at Ajios Dimitrianos, about 200 m. south of Kephlovryso; some hundred meters from the beginning of the real plain, on a slope much furrowed by the streams and the winter-rains (Plan II, 2), and on the eastern bank of a small river, which, in the winter time, flows between Ajios Dimitrianos and Lakkovounara. The plot is number 78 on the Landregistry Office map, on which it is called Hali-land. The Neolithic finds could be traced over a rather extensive area, from the river mentioned, up to the road which leads to Kamilostrada.

The rock is nearly everywhere visible, and consists of very soft, oblique layers of *chonnos* rock (Fig. 106). The earth, which lies here and there in the depressions, is derived from this rock which crumbles very easily. The earth of the settlement has this characteristic but is very hard, and in the deeper layers, hardly distinguishable from the real rock. (It is interesting to note that in Cyprus, this kind of earth is considered to be the best thing with which to cover roofs of houses. According to the labourers, it does not let any water through, and in such way, this *chonnos* is used in many villages on the slopes of the Kyrenia hills).

Water is to be found at many places near the settlement, but it is not suitable for drinking. It contains so much salt that it makes even vegetable-growth impossible along the bottoms of the valleys, where long white lines of salt crystals are often to be seen. This degree of saltiness does not allow any trees or bushes to grow, so that the fantastically furrowed landscape has the expression of complete solitude (Fig. 106).

The settlement once covered an area of about 10,000 sqm., but a great part of it has now been washed away by the streams, so that the remains of the settlement, still *in situ*, are to be found only on the tops of the hills within that area. Contrarywise, fragments of pottery and stone implements were found hundreds of meters below the site, washed away by the rains.

The excavation was started at a place where a circular wall, traceable on the surface, showed that the layers beneath were *in situ*, and was enlarged on both sides of this point.



Fig. 106. Kythrea. The site of the Neolithic settlement before excavation.

ARCHITECTURE (Plan XII)

Hut I (Fig. 108). Of this hut only the north-eastern portion is preserved, but almost certainly, the hut had originally a circular shape. The southern part with the entrance has now disappeared. The circular wall, about 0.70 m. wide, is solidly built of large rubble brought from elsewhere. The stones vary from 0.20 m. to 0.60 m. in length, the bulk of them being about 0.50 m. The largest are placed on the inside of the wall, which is more carefully worked. The wall is not built on the rock, the stones being simply laid in one course on the loose earth. All the stones are almost of the same thickness and the wall never seems to have been higher (c. 0.30 m.).

The floor of this hut was rather difficult to distinguish from the hard *chonnos* above and below it, but, at level 86.0 a layer was proved to be the floor of the hut. It is sunk slightly in the centre and consists only of hard rammed *chonnos* earth.

The south-western part of the floor is now washed away, with the corresponding part of the circular wall. On the east side of the floor, two rows of raised stones can be seen

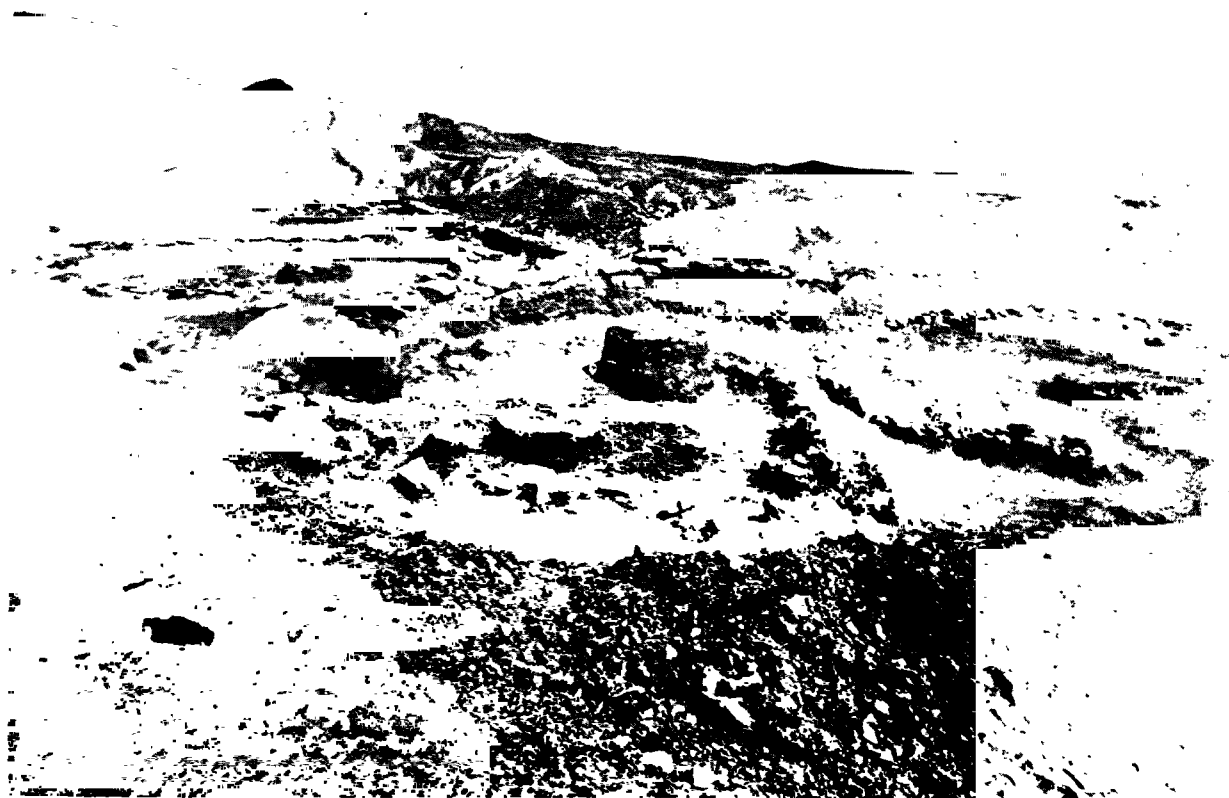

Fig. 107. Kythrea. The excavated huts.

radiating from the circular wall towards the centre. These can best be explained with Hut II (cf. below).

Near the centre of the hut a circular platform, 1.00 m. in diam. and 0.10 m. high, was found; it was constructed of small flat stones in three layers, bonded together by hard, red clay. As no charcoal, or traces of fire were found in connection with this platform, it appears to have been the base for a prop, or support for the roof of the hut; this suggestion was confirmed some days later, when the clay had dried up, for in the centre of the platform, a light, almost white square could be distinguished, where, probably, the support itself once stood (Fig. 109).

Hut II (Fig. 110). Immediately north of the first hut, the foundations of another were excavated. This second hut was of the same type as the preceding, but in a more perfect state of preservation. The circular wall is of about the same width as the wall in Hut I and built in the same way, with a carefully worked inside face: on the outside, some stones are missing in the north-eastern part of the wall. The entrance of the hut is to the S. W. close

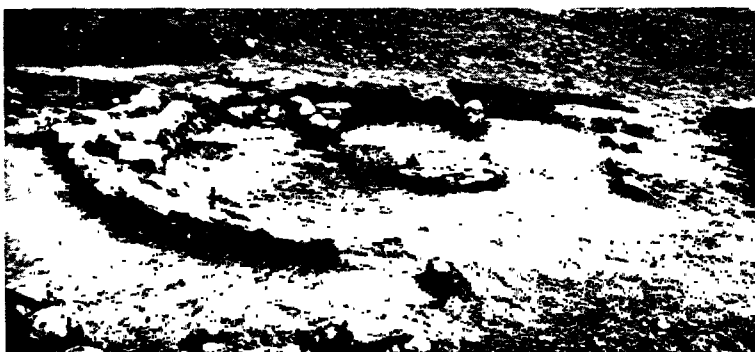

Fig. 1c8. Kythrea. Hut I.

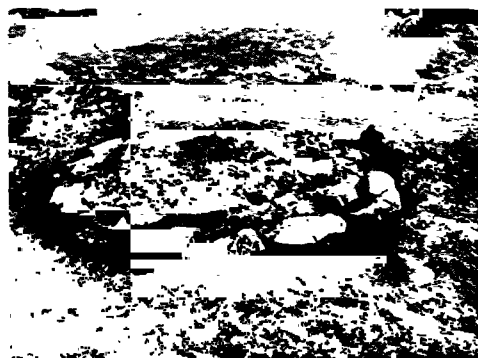

Fig. 1c9. Kythrea. Hut I. Base for prop supporting the roof.

to the wall of Hut I; here, a large stone was placed across the width of the wall, probably as a base for a door jamb; the base, on the other side, was not found *in situ*.

The floor consisted of hard, rammed earth, at level about 90.0, and sloped slightly towards the entrance. Many stones were found scattered about on the floor, but after careful cleaning of the whole floor, with every stone left *in situ*, it was possible to see that they were laid in irregular rows, some of them raised as in Hut I; the rows always abutted on the outer wall. In one place, near the west side, the space enclosed by the row of stones and the outer wall was paved with small stones. All these divisions along the outer wall can probably be explained as places for storing food and corn. In the centre of this hut, a base for a central support was found, at level 90.8, similar to that in Hut I and here, too, a light, square patch was noticed after the clay had dried up.

Hut III is situated about 2.15 m. east of the preceding hut, and is of the same type. The circular wall, of similar construction to the two former huts, is slightly damaged on the East, owing to the ground being cut away on this side; its width is about 0.60 m. The entrance of the hut is, as in Hut II, from S. W., and the eastern base for the jamb is preserved.

The floor to this hut consisted of rammed, hard clay sloping slightly towards the centre and the entrance. Two floor layers were distinguishable, the upper, probably, being a reconstruction of the first one. In this hut, too, a base for a central support was found, built of small stones and clay as in the preceding huts; but it is not situated in the very centre of the hut, but a little to the West. In the centre, a layer of ashes and charcoal, about 3 cm. thick, was found, and was possibly the remains of a hearth, as the ashes were confined to a patch of about 1 m. in diam.

Above this hut the remains of another were preserved, which consist of a piece of a circular wall and some traces of its floor crossing Hut III; but the other parts of the upper hut have been washed down the above mentioned eastern slope by rain. This hut seems to be of the same type as Hut III and should, according to its position at a higher level, be of a later date (cf. p. 284).

Hut IV (Figs. 111, 112, 114—117) is situated partly below Hut I. The floor of Hut IV



Fig. 110. Kythrea. Hut II.

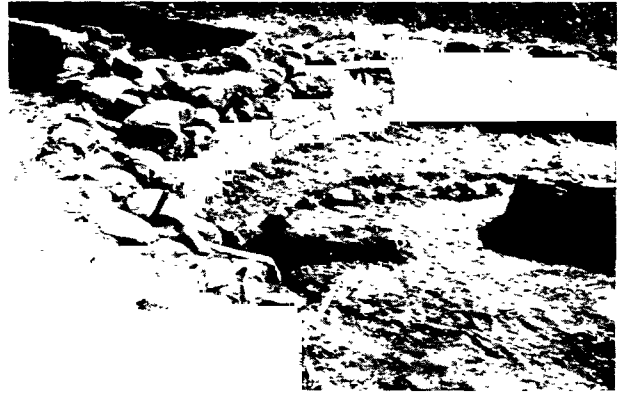

Fig. 111. Kythrea. Intersection of Huts I and IV.

was found at the level 83.5—82.0, and was different to the other floors described above, in that it consisted of a very hard, reddish clay, almost baked into terracotta. The encircling wall belonging to this floor consisted of an irregular row of small stones, about 0.10—0.20 m. in length, and could be traced on the west and part of the south side of the floor: on the West, the small stones were replaced by larger ones making a kind of uneven wall. Though the small stones were sometimes missing, it was not difficult to follow the circular shape of the hut owing to the hard, red floor, the edge of which was preserved all round. The entrance to this hut seems to have been on the S. W. The circular base for the central support was missing on this floor; but instead of this two holes for supports were found sunk in the floor in Square D 12 (Fig. 115); these holes were filled with grey, almost white clay which could be very easily distinguished from the red clay of the floor; on the surface of the latter black patches, and traces of fire could be seen.

Below this upper floor, another of similar kind was found at level 81.0. This floor was covered with a thin layer of ashes and charcoal (Fig. 115); apparently the first Hut IV was burnt, and a new floor laid at the time the hut was rebuilt.

In the lower hut, a base for a support was found a little to the west of the centre (Fig. 114): this base was built of exactly the same clay as the floor, but without any stones, and at its centre a small depression was noted. The top of the base is almost level with the upper floor. Below the lower floor, rock was found at level 80.0—78.0.

Hut V (Fig. 113) is situated to the south of Hut IV, their walls being only about 0.40 m. apart. The encircling wall is similar to that of Hut IV, and constructed of smallish stones loosely piled together, but in other respects, this hut is similar the Huts I, II, and III. Only the northern part of the hut is preserved, the remainder with the entrance having been washed away. At level 80.0, a rammed floor of earth was found, sloping slightly towards the South.

A base for the central support of the same type as in Hut I was built of small stones and hard clay. Below the floor, the rock was found at level 80.0—77.5.

The roofs of the huts have all been constructed in a similar way: probably, they consisted of a substructure of tree trunks standing on the circular wall, which was never higher, and

meeting against the central support, the base of which has been found on the floor of all the huts. These trunks were then covered with sticks and twigs and the whole caulked with clay. On the earlier floor of Hut IV, many lumps of this clay were collected; which when the hut burnt, became almost like a red terracotta. On one of the lumps, the rounded outline of the trunk could be traced on the inside; on the outside marks of the human hands and fingers could easily be recognized. Other lumps were proved to have been from the clay which had been pressed between the trunks, and on others again marks of twigs were noticed.

With the exception of the Hut IV B, which was burnt, all the huts seem to have been more or less cleared of their contents of minor objects before they were vacated by the inhabitants. In Hut IV B, however, several of the objects were found *in situ* as they were left when the hut was burnt, and were covered by its roof debris: in the north-western part, especially one got a very good impression of how the work of grinding, and chipping flint tools was carried on: the grinders and mortars were placed on the floor, and close to them the pestles were found: the small jug (No. 390) was still standing upright *in situ* on the floor and other pots were found lying broken on the floor. Apparently nothing had been removed after the disaster to the hut (Figs. 116, 117).

STRATIFICATION (Plan XII, 2)

DESCRIPTION OF LAYERS

The stratification of the settlement is conveniently divided by the various floors of the huts.

Hut I.

Stratum I A, c. 0.20 m. thick, is the layer above the floor of Hut I. In this layer no differentiation of the earth could be made; it consisted of dark, brown *chonnos* earth.

Stratum I B, c. 0.20 m. thick, is the layer between the floor of Hut I and level 84.0, which is the top of the circular wall of Hut IV, under Hut I. The earth was similar to that of the preceding layer.

Hut IV.

Stratum IV A, c. 0.10 m. thick, is the layer above the upper floor of Hut IV. This layer was exactly the same as the preceding. On the floor patches of ashes and blackened traces of fire were noted.

Stratum IV B, 0.12 m. thick, is the layer between the two floors of Hut IV including the baked clay of the upper floor. The upper part is of a dark reddish or buff colour; the lower consists of grey or light coloured clay.

Stratum IV C, c. 0.20 m. thick, is the layer between the lower floor and the rock. The earth of this layer is similar to the preceding in the upper part: near the rock it grows darker and browner, similar to the earth in the first hut.



Fig. 112. Kythrea. Hut IV.



Fig. 113. Kythrea. Hut V.

Hut II.

The earth here was excavated in two layers divided by the floor.

Stratum II A, 0.20 m. above the floor, is dark, brown earth of *chonnos* type.

Stratum II B, 0.20 m. below the floor. As the preceding layer.

Hut III.

Here the layers are more complicated, owing to the presence of the remains of the later hut, mentioned above (p. 280).

Stratum III A, at level 99.0—96.0, is a layer above the floor of the upper hut. It consists of hard, brown clay. On the floor of this hut, a thin layer of charcoal was found. The layer is only preserved in a small area covering Squares L 3—4, K 4.

Stratum III B, at level 96.0—95.0, is the layer between this upper hut and the upper reconstruction of the floor of the true Hut III. The earth was similar to the preceding layer.

Stratum III C, at level 95.0—94.0, is the filling of the reconstruction of the earlier floor.

Stratum III D, at level 94.0 — the rock, is the earth from below the floor to the rock.

Hut V.

The stratification of this hut is conveniently divided by the floor, which separates the layers

Stratum V A above the floor;

Stratum V B below the floor.



Fig. 114. Kythrea. Hut IV during excavation.

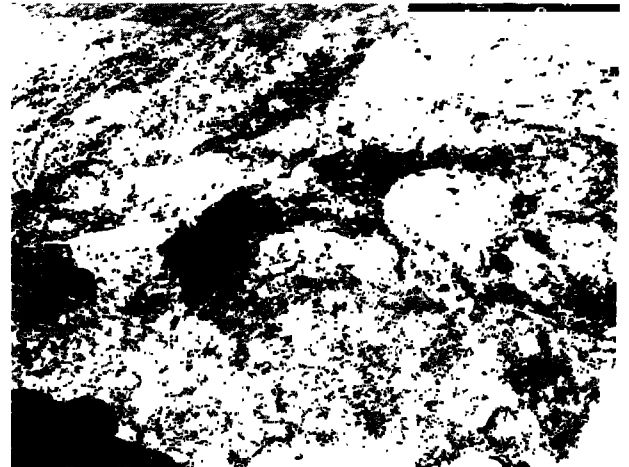

Fig. 115. Kythrea. Hut IV. Holes for props supporting the roof.

CHRONOLOGICAL ORDER OF THE LAYERS

To judge from the above described circumstances it is evident that a relative chronological order of these layers can be drawn up. On account of its position and level Hut IV must be earlier than the block of Huts I and II, which is built partly above it. Hut V is built on approximately the same level, close to, though not completely together with Hut IV and must, therefore, be considered as contemporary with this hut, more probably with its last period than its first one. Thus the layers IV A and V A are contemporary with each other, and slightly later than IV B.

The layer IV C below the floor of Hut IV is, however, earlier than all these layers. Outside these more or less connected huts, Hut III lies separate from Hut II. The levels of these huts show that the lower floor of Hut III must be of almost contemporary date with the floor of Huts I and II. The layer III C above the floor of Hut III is therefore considered to be contemporary with Layers I A and II A. The upper layers of Hut III must be of later date. As a layer below a floor in the case concerned must be earlier than the layer above it, the chronological order of the strata should be as follows:

1. IV C.
2. V B; IV B.
3. III D; II B; V A; IV A (I B).
4. III C; II A; I A.
5. III B.
6. III A.

On account of the stratigraphical evidence, the huts investigated can already be ascribed to two main periods: one group on a lower level with Huts IV and V, and to which the two lower strata have been ascribed; the second group, on the higher level containing Huts I, II, and III, are connected with Strata 4 to 6.



Fig. 116. Kythrea. Hut IV. Finds *in situ*.



Fig. 117. Kythrea. Hut IV. Finds *in situ*.

CLASSIFICATION OF HUTS

It is evident that these five huts can be divided typologically into two classes corresponding to the different periods. The huts of Period II (Huts I, II, III) have wide walls built of large stones: the floors consist of rammed, black earth, and the base for the central support is built of small stones in two or three layers, bound together with hard, brown clay. The huts of Period I, (Huts IV and V), on the contrary, had encircling walls built of small stones piled loosely together in rows: the two floors of Hut IV consisted of hard, (baked) clay, possibly owing to the fire and the central supports were, in the first period, made entirely of clay, in the second, simply let into holes in the floor. As has been mentioned before, Hut V has features of both these types, the wall being similar to that one of Hut IV, the floor and the base like those in Huts I, II, and III.

The characteristic architectural features as distributed among the different huts are shown in the following diagram.

Period	Layer	Thick, encircling wall	Floor of black earth	Base for central support built of clay and stones	Thin wall	Floor of terracotta	Base for the support built only of clay	Support placed in a hole in the floor
I	IV B				—	—	—	
	IV A				—	—		—
	V A		—	±	±			
II	III C II A I A	+	+	—				
	III A	—	±	(—)				

FINDS (Pls. XI, XII, XIII, XCIII, 7—13)

OBJECT REGISTER

1. Scraper of white flint with one cutting edge, retouched all round. Length 5.5. Trench I. F 4.* 95.0.**
2. Chip of red flint. Length 7.5. Trench I. G 3. 96.5.
3. Fragment of a polished chisel. Length 4.0. I A.*** F 11. 87.0.
4. Knife of grey flint; one side flat, the other with midrib; one edge slightly retouched. Length 6.0. I A. D 12. 86.5.
5. Scraper of grey flint; one side flat; retouched edge. Length 5.5. II A. E 10. 89.6.
6. Scraper of grey flint; one side flat, the other with midrib. Length 5.7. II A. F 10. 89.6.
7. Chip of grey flint. Length 6.6. I A. G 12. 87.5.
8. Fragment of a knife of red flint; single cutting edge. Length 9.8. I A. G 12. 87.5.
9. Knife of brown flint with two finely retouched edges; one side flat, the other with a high midrib. Length 9.8. I A. F 13. 88.3.
10. Knife of white flint, shape as No. 9. Length 6.3. I A. G 13. 88.7.
11. Scraper of red flint; triangular shape. Length 8.6. I A. G 13. 88.4.
12. Scraper of grey flint with rounded, very finely retouched edge; one side flat, the other side convex. Length 4.0. I A. G 13. 89.0.
13. Scraper of brown flint, oblong; edges very finely retouched all round; one side flat, the other with midrib. Length 9.5. II A. H 7. 91.8.
14. Flake of grey flint; one side flat, the other with midrib. Length 6.4. I A. F 14. 86.2.
15. Arrow-head of yellow flint; one side finely retouched. Length 3.3. I A. F 13. 86.5.
16. Chip of white flint. Length 6.3. V A. H 16. 91.5.
17. Scraper of brown flint, triangular shape; one end retouched from two sides, the other side retouched as usually. Length 3.6. II A. F 9. 91.5.
18. Chip of white flint. Length 3.3. II A. E 5. 91.7.
19. Chip of white flint. Length 5.2. II A. E 6. 92.5.
20. Knife of greyish brown flint with two edges; one side flat; two distinct ribs on the other, one end is very thick. Length 8.5. II A. E 6. 92.5.
21. Scraper of brown flint with two edges; one concave, the other convex; one flat side, the other with midrib. Length 4.2. V A. H 15. 83.0.
22. Chip of grey flint. Length 5.3. V A. H 16. 83.0.
23. Knife of grey flint, as No. 9. Length 8.0. V A. H 16. 83.0.
24. Scraper of grey flint; one edge retouched. Length 5.6. I A. G 13. 86.3.
25. Slightly curved flake of grey flint. Length 5.2. I A. G 13. 86.4.
26. Splinter of grey flint; one side with midrib. Length 4.6. I A. G 14. 86.0.
27. Scraper of grey flint with one edge convex; the other angular; one side flat, the other with midrib. Length 5.6. I A. G 13. 88.3.
28. Chip of white flint. Length 3.0. II A. D 7. 91.2.
29. Chip of grey flint; one edge with four saw-teeth. Length 8.4. II A. F 9. 90.6.
30. Scraper of brown, light flint; triangular shape; two concave sides; one straight edge. Length 8.5. II A. E 6. 90.4.
31. Thick axe-head of basalt, convex edge; bulging sides, narrow top. Length 10.0. II A. E 5. 90.2.
32. Scraper of grey flint; one side flat, the other with two ribs; edge finely retouched. Length 6.7. Outside the wall. I 7. 93.0.
33. Knife of white flint; slightly curved; one side flat; edges retouched. Length 7.5. II A. E 6. 89.8.
34. Flake of white flint; triangular section. Length 5.1. II A. E 6. 89.8.
35. Flake of brown flint; triangular shape; one edge slightly retouched. Length 3.0. II A. E 6. 91.0.
36. Pointed chip of grey flint; one flat side. Length 5.5. II A. E 6. 90.0.
37. Disc-shaped whetstone. Length 5.3. II A. D 6. 91.5.
38. White flint, shaped like an arrow-head with one edge straight, the other convex, one side flat and the other with midrib; a projection like a tang at one end. Length 5.6. II B. E 6. 89.4.
39. Fragment of a white flint knife with triangular section. One cutting edge retouched. Length 3.9. II A. E 6. 90.0.
40. Scraper of brown flint with a rounded, slightly retouched edge. One side flat. Length 4.4. II A. E 7. 92.0.
41. Thin, triangular axe-head of basalt with straight edge and broad top. Length 5.6. II B. G 9. 89.7.
42. Scraper of brown flint with a finely retouched edge and semicircular section. Length 5.2. II B. G 9. 88.7.
43. Chip of brown flint. Length 7.3. II B. G 9. 88.7.
44. Chip of brown flint, belonging to No. 43. Length 7.0. II B. G 9. 88.7.
45. Flat chip of brown flint. Length 5.3. II B. G 9. 89.0.
46. Scraper of brown flint, as No. 42. Length 6.0. I B. E 14. 85.3.
47. Knife of grey flint with two edges. one side flat, the other with two ribs. Length 9.5. I A. E 13. 86.0.
48. Chip of flint with sharp edges. Length 4.3. I A. E 13. 85.9.
49. Chip of flint. Length 4.3. I A. E 13. 85.7.
50. Chip of brown flint. Length 9.0. I B. E 13. 85.3.
51. Knife of white flint; one side flat, the other with midrib. Length 7.6. V A. H 16. 82.2.
52. Scraper of grey flint. Length 5.7. V A. H 16. 82.2.
53. Scraper of grey flint with triangular shape; three edges; one side flat, the other with three ribs. Length 5.7. V A. H 16. 82.2.

* Square. ** Level. *** Layer.

54. Circular lid of greenstone with a convex projection to fit into the neck of a jar. Diam. 9.2. I A. H 14. 86.2.
55. Pestle of greenstone, in the shape of a truncated cone, with ovoid section. Length 11.8. I A. G 14. 86.5.
56. Flake of brown flint; one side flat, the other with midrib. Length 6.2. II A. D 7. 91.5.
57. Fragment of an idol of yellow marble. The piece seems to be a part of the right leg of a plank-shaped idol, the legs of which have been divided by a vertical groove, seen on the fragment. The piece widens towards one (upper) end, and is fractured on three sides. Length 9.0. II A. D 7. 89.7.
58. Pointed chip of grey flint; one side flat, the other with a very high midrib. Length 5.3. II A. D 7. 89.5.
59. Fragment of a black flint knife. Length 3.4. II A. E 7. 90.8.
60. Chip of grey flint. Length 5.1. II A. E 7. 90.1.
61. Chip of grey flint. Length 4.5. II B. E 7. 88.5.
62. Scraper of grey flint; one side convex. Length 7.1. II B. D 7. 88.5.
63. Chip of grey flint. Length 5.6. II A. D 8. 89.0.
64. Flake of white flint. Length 6.0. II A. E 8. 89.5.
65. Flake of grey flint with triangular section. Length 5.2. II A. F 8. 90.0.
66. Chip of white flint. Length 7.0. II A. F 8. 89.5.
67. Scraper of grey flint with two convex edges meeting in a point; one side flat, the other with two ribs. Length 6.4. II A. G 7. 91.5.
68. Chip of grey flint with sharp edges. Length 3.8. II A. G 7. 92.5.
69. Knife of greyish white, soft flint; two ribs finely retouched; one side flat, the other with midrib; rounded point. Length 4.7. II A. G 7. 92.0.
70. Chip of grey flint. Length 4.4. II A. G 7. 91.2.
71. Chip of red flint with sharp edges. Length 5.2. II A. G 7. 91.5.
72. Chip of grey flint. Length 3.9. II A. G 8. 90.5.
73. Chip of brown flint, with finely retouched edge. Length 3.1. III B. K 2. 95.8.
74. Chip of flint. Length 3.9. III B. K 2. 95.8.
75. Chip of white flint. Length 3.6. III B. K 2. 95.8.
76. Chip of white flint with slightly retouched edges. Length 2.7. III B. K 2. 95.8.
77. Chip of brown flint. Length 3.0. III B. K 2. 95.8.
78. Scraper of brown flint. Length 3.7. III B. K 2. 95.8.
79. Chip of grey flint. Length 2.9. III B. K 2. 95.8.
80. Chip of grey flint. Length 2.8. III B. K 2. 96.3.
81. Flake of white flint with triangular section. Length 3.2. III B. K 2. 95.3.
82. Knife of grey flint with triangular section. Length 6.0. III B. K 3. 96.8.
83. Chips of flint of light red colour, shape like a scraper but without cutting edges. Length 4.8. III B. K 2. 95.7.
84. Chip of grey flint, not retouched. Length 6.7. III B. J 2. 95.0.
85. Knife of grey flint with two finely retouched edges, one side flat, the other with a rather low midrib. Length 7.1. III B. L 2. 96.5.
86. Flake of red flint with slightly retouched edge. Length 3.0. III B. J 2. 96.0.
87. Broad scraper of grey flint; one side flat; the other with midrib; finely retouched, rounded edge. Length 8.0. Outside the hut. H 3. 94.3.
88. Knife of white flint, as No. 85. Length 6.2. Outside the hut. I 4. 94.2.
89. Irregular chip of white flint. Length 4.0. III B. K 2. 95.8.
90. Flake of grey flint. Length 4.5. I B. E 13. 85.3.
91. Leaf-shaped, slightly curved knife of grey flint with triangular section; both cutting edges roughly retouched. Length 7.5. III B. K 3. 95.8.
92. Thin flake of grey flint. Length 3.7. II A. F 7. 91.0.
93. Scraper of grey flint with sharp edges; one side convex, the other flat. Length 5.1. II A. G 6. 90.0.
94. Scraper of white flint with two straight edges meeting in a rounded top; one flat side, the other with midrib; projection like a tang, at one end. Length 5.1. Outside the hut close to the wall. K 1. 96.0.
95. Scraper of white flint; irregular retouchings around the whole flint. Length 3.8. III B. K 2. 95.5.
96. Flake of grey flint. Length 6.2. II B. E 6. 97.0.
97. Grey flint; pointed, (arrow-head?) with no cutting edges. Length 5.5. II A. G 6. 90.0.
98. Scraper of white flint with retouched edges all round; one side flat, the other with midrib. Length 4.8. I A. F 13. 87.0.
99. Stone pestle of basalt shaped as a truncated cone, slightly damaged at the base. Length 10.5. I A. F 13. 87.0.
100. Knife of white flint, as No. 9. Length 5.8. IV A. E 13. 86.0.
101. Scraper of grey flint; one rounded edge finely retouched; marked tang. Length 5.1. II A. F 8. 89.8.
102. Fragment of a green steatite idol, probably of the same shape as No. 412. The fragment consists of one arm and parts of head and body. Length 2.6. III C. M 2. 94.3.
103. Chip of grey flint without cutting edges; one projection like the tang of a scraper. Length 4.1. III C. M 2. 94.6.
104. Knife of grey flint, leaf-shaped, with one flat side, the other with three ribs; one edge finely retouched. Length 8.5. I A. E 13. 86.5.
105. Chisel of basalt with elliptical section; sharp edge, rounded neck. Length 5.0. II B. G 9. 89.1.
106. Scraper of grey flint with sharp edge. Length 4.6. III A. J 3. 96.0.
107. Knife of white flint with one side flat, the other with midrib. Length 7.0. III A. J 3. 96.0.
108. Knife of greyish brown flint; one edge; one side flat, the other with a rib near the blunt edge. Length 6.1. III A. J 3. 96.0.
109. Chip of calcareous flint. Length 4.1. III A. J 3. 96.0.

110. Knife of white flint with one side flat, the other with midrib; lancet-shaped, with two retouched edges. Length 6.2. III A. K 3. 96.0.
111. Chip of grey flint. Length 3.2. IV A. C 13. 83.5.
112. Chip of white flint. Length 3.5. IV A. D 13. 83.3.
113. Chip of grey flint. Length 3.3. IV A. D 13. 84.8.
114. Knife of grey flint; leaf-shaped, with one side flat, one cutting edge retouched. Length 9.0. IV A. D 12. 85.0.
115. Scraper of grey flint; one side flat, the other convex; sharp edge not retouched. Length 7.0. IV A. D 12. 85.1.
116. Thin flake of grey flint. Length 6.3. IV A. D 12. 84.0.
117. Scraper of white calcareous flint, now rather worn; one cutting edge retouched. Length 5.5. IV A. D 12. 84.1.
118. Flake of grey flint; one side flat, the other side convex. Length 7.2. IV A. D 12. 83.8.
119. Scraper of white flint of oval shape; one side flat, the other with midrib; cutting edge slightly retouched. Length 8.2. IV A. D 13. 83.7.
120. Knife of white flint with one convex, curved, finely retouched edge; one side flat, the other with midrib; rounded point. Length 4.0. IV A. D 14. 83.5.
121. Chip of white flint. Length 4.5. I A. E 12. 86.0.
122. Chip of grey flint of triangular shape. Length 6.5. I A. E 11. 86.0.
123. Flake of brown flint; one side flat, the other with midrib; one edge slightly retouched. Length 4.2. I A. E 11. 86.0.
124. Knife of grey flint, as No. 9. Length 7.8. I A. F 12. 86.1.
125. Fragment of a knife of brown flint; triangular section. Length 4.5. I A. F 12. 86.0.
126. Arrow-head of brown flint with triangular section; one edge retouched. Length 3.1. I A. F 12. 86.3.
127. Chip of grey flint. Length 4.7. I A. F 12. 85.2.
128. Scraper of white calcareous flint; trapezoid cutting edges retouched all round. Length 5.1. I A. F 12. 86.5.
129. Flake of grey flint with triangular section. Length 3.9. I A. F 13. 86.3.
130. Knife of grey flint; two roughly retouched edges; one side flat, the other with high midrib; rounded point. Length 5.1. I A. F 12. 86.8.
131. Scraper of brown flint; one side flat; the other with midrib. Length 2.8. I A. F 12. 86.6.
132. Scraper of white flint with a slightly projecting tang; one side flat; the other with midrib. Length 4.0. I A. F 13. 85.5.
133. Scraper of grey flint; roughly triangular shape; one retouched edge; one side flat, the other with midrib and flat top. Length 6.2. I A. E 13. 85.5.
134. Scraper of grey flint with one side flat; the other with midrib; one finely retouched edge. Length 3.5. I A. G 13. 85.6.
135. Chip of brown flint, one side flat; the other with midrib. Length 3.0. I A. H 13. 85.5.
136. Scraper of grey flint with one edge concave, the other convex; one flat side, the other with midrib. Length 5.7. III B. L 1. 95.0.
137. Chip of flint. Length 5.0. III B. L 2. 95.0.
138. Scraper of light brown flint with triangular shape; two straight edges, one side flat, the other with midrib. Length 5.0. III B. L 2. 95.0.
139. Chip of flint. Length 3.7. III B. L 2. 95.0.
140. Knife of greyish brown flint with two edges; one side flat, the other with two ribs. Length 6.0. III B. L 2. 95.3.
141. Chip of grey flint; roughly circular shape; one side convex, the other side purposely chipped; one rounded edge. Length 4.4. III B. L 2. 95.3.
142. Chip of flint. Length 4.5. III B. K 3. 95.3.
143. Scraper of grey flint with two concave edges meeting in a point, one flat side, the other with midrib. Length 6.3. III B. K 3. 95.3.
144. Flake of white flint with double edge; small, boat-shaped; irregular. Might have been an arrow-head. Length 4.1. III B. K 3. 95.3.
145. Chip of flint. Length 7.1. III B. K 3. 95.3.
146. Chip of flint. Length 4.2. III B. K 3. 95.3.
147. Chip of flint. Length 4.0. III B. K 3. 95.3.
148. Chip of flint. Length 3.7. III B. J 3. 95.0.
149. Chip of white flint with triangular section. Length 3.3. III B. J 3. 95.0.
150. Arrow-head of grey flint with triangular section and projecting tang. Length 2.9. III B. J 3. 95.0.
151. Scraper of white flint with one straight and one convex edge meeting in a point; both sides flat. Length 4.6. III B. J 3. 95.0.
152. Circular, flat grindstone of dolerite with a cavity in the centre of the top. Length 4.9. III B. J 4. 95.8.
153. Chip of flint. Length 3.7. III B. J 4. 96.4.
154. Scraper of white flint with only one convex edge; one flat side, the other with rib. Length 4.7. III B. L 4. 95.3.
155. Chip of flint. Length 5.2. III B. L 4. 94.3.
156. Scraper of grey flint with one straight edge, the other convex-concave; one side flat, the other with midrib. Length 4.2. III B. L 1. 95.0.
157. Chip of flint. Length 6.5. III B. L 1. 94.5.
158. Scraper of flint with one side flat, the other side with two ribs, one straight and one convex edge. Length 4.0. III B. L 1. 94.3.
159. Flake of a light brown flint shaped like an arrow-head, with one straight and one convex edge; one side flat, the other with midrib, projecting tang. Length 6.9. III B. J 4. 96.4.
160. Scraper of grey flint with one side flat; the other with midrib; one curved edge. Length 4.3. III B. K 4. 96.0.
161. Scraper of brown flint one side flat; the other with midrib; rounded, slightly retouched edge; wide tang. Length 6.5. II A. C 7. 90.0.
162. Core of flint. Length 7.0. II A. C 7. 90.0.

163. Knife of white flint with parallel sides; point broken; one side flat; the other with midrib; one edge finely retouched; slightly projecting tang. Length 5.8. II A. C 7. 90.0.
164. Knife of white, soft flint; one cutting edge, slightly retouched. Length 8.0. II A. C 7. 90.0.
165. Scraper of white, hard flint; one side flat; the other with two ribs; wide, projecting tang; rounded edge, finely retouched. Length 5.0. II A. E 7. 89.6.
166. Scraper of brown flint; one side curved; the other with two ribs; rounded retouched edge. Length 5.0. II A. E 7. 89.6.
167. Pointed chip of grey flint with one slightly retouched cutting edge. Length 6.0. II A. E 7. 89.6.
168. Knife of grey flint, as No. 344, but with low midrib. Length 5.4. III B. K 4. 96.0.
169. Scraper of white flint; one side flat; the other with midrib, slightly projecting tang; rounded, retouched edge. Length 4.7. III B. K 4. 96.0.
170. Leaf-shaped chip of grey flint with long projecting tang; one side curved; the other with midrib. Length 9.2. II A. G 7. 90.0.
171. Scraper of grey flint, one side flat; the other with two ribs; rounded, retouched edge. Length 4.4. II A. G 7. 90.0.
172. Flat scraper of white flint; projecting tang. Length 4.5. II A. H 7. 90.0.
173. Pointed knife of grey flint with two cutting edges; slightly marked tang. Length 5.4. I B. E 12. 85.2.
174. Scraper of grey flint with triangular section; slightly retouched edge. Length 3.3. I B. E 12. 85.2.
175. Chip of brown flint with triangular section; edge damaged; long projecting tang. Length 4.7. I B. E 12. 85.2.
176. Scraper of grey flint with slightly marked tang; retouched, rounded edge. Length 3.2. I B. E 12. 85.2.
177. Fragment of knife of grey flint with triangular section; one unretouched cutting edge. Length 5.0. I B. E 12. 85.2.
178. Scraper of grey flint with marked tang. Length 3.4. I B. E 12. 85.2.
179. Core of grey flint. Length 5.5. I B. E 12. 85.2.
180. Flake of grey flint; one side flat; the other with midrib; one edge. Length 4.1. I B. E 12. 85.2.
181. Scraper of grey flint with rounded, finely retouched edge. Length 3.5. I B. E 12. 85.2.
182. Flake of grey flint with projecting tang. Length 5.0. I B. F 12. 85.2.
183. Flake of grey flint. Length 4.1. I B. F 12. 85.2.
184. Flake of white flint. Length 4.6. I B. F 12. 85.5.
185. Leaf-shaped knife of grey flint; one side with midrib; two unretouched cutting edges. Length 4.7. I B. E 12. 85.5.
186. Scraper of white flint with retouched edge. Length 2.1. I B. E 13. 84.5.
187. Scraper of greyish brown flint; one side flat; the other with midrib; two convex edges. Length 5.3. I B. D 13. 84.5.
188. Scraper of brown flint; one side flat; the other with two ribs; rounded, retouched edge. projecting tang. Length 4.4. I B. E 14. 83.4.
189. Scraper of brown flint. Length 4.2. I B. E 14. 83.4.
190. Flake of grey flint; one side convex; roughly retouched edges. Length 8.2. III A. L 3. 96.0.
191. Flake of white, hard flint. Length 3.2. III B. K 4. 94.7.
192. Scraper of white flint with projecting tang; one retouched cutting edge. Length 3.3. III B. K 4. 94.7.
193. Flake of black flint. Length 4.3. III B. K 4. 94.7.
194. Fragment of a knife of white flint with marked tang. Length 3.6. III B. J 4. 95.9.
195. Scraper of grey flint with projecting tang; damaged edge. Length 4.3. III B. J 4. 94.7.
196. Scraper of grey flint with long, projecting tang; damaged edge. Length 6.4. Stray find.
197. Scraper of grey flint with rounded, retouched edge. Length 3.2. Stray find.
198. Flat scraper of brown flint; one side with midrib; straight, unretouched edge. Length 7.5. II A. C 7. 90.0.
199. Knife of grey flint with projecting tang; one slightly retouched edge. Length 6.1. IV A. E 15. 83.8.
200. Knife of red flint with projecting tang, unretouched edge. Length 5.3. IV A. F 15. 82.5.
201. Knife of grey flint with one cutting edge, slightly retouched. Length 4.5. V A. F 15. 84.2.
202. Knife of grey flint with one cutting edge, slightly retouched. Length 5.0. V A. F 15. 84.2.
203. Flake of grey flint with two cutting edges; one side flat. Length 7.0. V A. G 15. 84.8.
204. Knife of grey flint, flat, curved neck and slightly retouched cutting edge. Length 7.5. V A. G 15. 83.5.
205. Scraper of brown flint; one side flat, the other convex; slightly retouched edge. Length 5.2. II B. C 7. 88.2.
206. Circular, flat grindstone of dolerite with a cavity in the centre of the top. Diam. 8.5. II B. C 7. 88.2.
207. Short knife of grey flint with one rounded cutting edge and marked tang. Length 4.1. II B. D 7. 88.0.
208. Thick scraper of grey flint with marked tang and roughly retouched edge. Length 7.0. II B. C 7. 88.0.
209. Scraper of grey flint; one side flat; the other convex; roughly retouched, rounded edge. Length 5.2. II B. D 6. 90.3.
210. Chip of flint. Length 5.6. II A. F 7. 89.5.
211. Flat scraper of grey flint with marked tang. Length 4.2. II A. F 7. 90.0.
212. Scraper of red flint with rounded, finely retouched edge. Length 4.7. II A. F 7. 90.0.
213. Flake of dark flint with sharp edges. Length 1.8. II A. F 7. 89.5.
214. Slightly curved, leaf-shaped knife of brown flint; one side with two ribs. Length 4.5. II A. F 7. 90.2.
215. Thin flake of grey flint. Length 4.7. II A. F 7. 89.0.
216. Pestle of greenstone in the shape of a truncated cone. Length 10.0. II B. E 6. 89.5.

217. Scraper of brown flint: one side curved; the other with midrib; finely retouched edge; slightly marked tang. Length 3.1. II A. F 7. 89.5.
218. Thin scraper of white flint with rounded, finely retouched edge. Length 4.1. II A. F 7. 89.5.
219. Thin scraper of white flint with very finely retouched edge; projecting tang. Length 3.6. II A. F 7. 89.5.
220. Scraper of grey flint; one side flat; the other convex; roughly retouched edge; marked tang. Length 5.7. II B. G 6. 89.5.
221. Pebble used as a whetstone. Length 8.2. II B. G 6. 89.7.
222. Scraper of grey flint, as No. 92. Length 4.5. II B. G 6. 89.6.
223. Handle of a stag's horn; fragmentary. Length 4.6. II A. G 6. 90.0.
224. Triangular, flat scraper of white flint with rounded, finely retouched edge; projecting tang. Length 6.9. II B. G 6. 90.0.
225. Scraper of brown flint, as No. 224. Length 5.1. III C. L 3. 94.0.
226. Chip of white flint; one side flat, the other with midrib; slightly projecting tang. Length 4.5. III C. M 2. 94.2.
227. Chip of white flint. Length 4.2. III C. M 2. 94.2.
228. Chip of grey flint. Length 3.9. III C. M 2. 94.5.
229. Chip of brown flint. Length 3.2. III C. L 2. 94.5.
230. Short knife of white flint with one cutting edge; projecting tang. Length 4.3. III C. M 2. 94.6.
231. Scraper of white flint; one side flat; rounded, retouched edge; marked tang. Length 5.0. III C. L 2. 94.6.
232. Chip of white, soft flint. Length 3.9. III C. L 2. 94.5.
233. Knife of white, hard flint with one cutting edge. Length 4.5. III C. L 2. 94.0.
234. Knife of grey flint with parallel edges; one side with midrib; slightly marked tang. Length 6.4. III C. L 4. 93.8.
235. Scraper of white flint with finely retouched edge. Length 4.7. III C. L 4. 94.0.
236. Scraper of white flint; one side flat, the other slightly convex; rounded edge, slightly retouched. Length 3.7. III C. M 4. 94.4.
237. Chip of flint. Length 3.5. III C. L 2. 94.3.
238. Chip of brown flint with retouched edge. Length 3.9. III C. M 3. 94.0.
239. Long scraper of brown flint; one side flat; the other with midrib; rounded, retouched edge. Length 5.5. III C. M 2. 94.9.
240. Knife of brown flint with one cutting edge. Length 5.0. III C. L 2. 93.9.
241. Scraper of grey flint with damaged, retouched edge and stout tang. Length 6.0. I B. D 12. 84.3.
242. Knife of white flint with one finely retouched cutting edge; marked tang. Length 5.0. I B. E 12. 84.5.
243. Chip of dark flint; pointed, with two sharp edges. Length 4.1. I B. E 11. 84.4.
244. Scraper of white flint with elliptical section, finely retouched edge; well marked tang. Length 7.5. I B. D 13. 83.6.
245. Thick knife of grey flint with flat neck; roughly retouched edge. Length 8.3. I B. G 12. 85.2.
246. Chip of white flint, as No. 243. Length 4.7. I B. F 12. 83.5.
247. Scraper of white flint; one side flat; the other side with two ribs; rounded, retouched edge; stout tang. Length 8.4. III C. K 3. 94.0.
248. Scraper of black flint with roughly retouched edge; well marked tang. Length 4.8. III C. K 3. 94.0.
249. Large scraper of white flint; one side flat, the other with rib; finely retouched edge; stout tang. Length 8.0. III C. L 3. 94.0.
250. Knife of brown flint; one side flat, the other with two ribs; two sharp edges. Length 5.2. III C. L 2. 94.0.
251. Knife of greyish brown flint; one side flat; the other with high midrib; two cutting edges. Length 5.2. III C. L 2. 94.0.
252. Knife of brown flint with triangular section; unretouched edges. Length 6.3. III C. L 2. 94.0.
253. Flat knife with curved neck and sharp edge. Length 7.2. III C. L 2. 94.0.
254. Knife of brown flint; one side flat, the other with midrib; slightly retouched edge; slightly marked tang. Length 7.0. III C. M 2. 94.0.
255. Knife of white flint, as No. 253. Length 5.2. III C. M 2. 94.0.
256. Knife of brown flint with one cutting edge and flat neck. Length 5.3. III C. M 2. 94.0.
257. Knife of grey flint with triangular section. Length 4.9. III C. M 2. 94.0.
258. Chip of brown flint with double edges; small and boat-shaped. Length 2.8. III C. M 2. 94.0.
259. Wide, flat knife of grey flint with roughly retouched edges. Length 6.0. IV A. C 12. 85.9.
260. Knife of grey flint with triangular section; marked tang. Length 7.2. IV A. C 12. 84.5.
261. Core of flint. Length 7.5. I B. B 12. 85.0.
262. Drop-shaped pendant of blue stone pierced at the upper end. Length 1.9. Found by Miss du Plat Taylor south of excavation.
263. Fragment of a marble idol? The piece is flat, with rounded edges and broken on one short side. Length 4.3. II B. G 6. 89.5.
264. Chip of grey flint. Length 4.3. II B. F 6. 89.5.
265. Flat whetstone. Length 6.7. II B. F 6. 89.5.
266. Thin scraper of grey flint with finely retouched edge and long projecting tang. Length 4.7. II B. F 6. 89.5.
267. Thick scraper of grey flint with damaged edge and projecting tang. Length 6.1. II B. F 6. 89.5.
268. Leaf-shaped scraper of grey flint; one side flat, the other with midrib; two parallel cutting edges; edge on short side finely retouched. Length 5.9. II B. F 6. 89.5.

269. Curved knife of brown flint; one side with midrib. Length 5.3. II B. F 6. 89.5.
270. Scraper of grey flint; one side flat, the other convex; rounded, retouched edge. Length 6.2. II A. G 7. 89.5.
271. Scraper of white flint with one rounded edge, the other retouched; flat neck. Length 5.6. II A. F 7. 89.5.
272. Knife of brown flint with a triangular section; one cutting edge. Length 5.7. II A. G 7. 89.5.
273. Scraper of grey flint; one side flat, the other with midrib; straight edge; long tang. Length 6.6. II A. G 7. 89.5.
274. Scraper of red flint; rounded, retouched edge; marked tang. Length 4.6. II A. H 7. 89.5.
275. Chip of flint. Length 6.1. II B. F 6. 89.5.
276. Piece of a leaf-shaped knife of white flint; single cutting edge. Length 4.2. II B. F 7. 89.5.
277. Scraper of grey flint with a slightly retouched edge; long tang. Length 7.1. I B. F 14. 84.5.
278. Flake of grey flint of irregular shape. Length 9.6. I B. H 14. 84.5.
279. Scraper of grey flint of irregular shape; one edge slightly retouched. Length 7.8. I B. H 13. 83.5.
280. Fragment of a grinder of greenstone with rounded edge; one side worn flat. Length 6.8. Found outside the wall in G 15. 81.8.
281. Knife of black flint; one side flat, the other with flat ridge; one cutting edge finely retouched. Length 7.3. Found outside the wall in E 16. 82.2.
282. Thin scraper of grey flint; one side with midrib; long, projecting tang. Length 5.2. V A. E 16. 80.5.
283. Fragment of idol of green steatite; the fragment is cylindrical in shape and is pierced at one end, the other fractured; one side straight-cut. Length 4.5. V B. E 16. 80.5.
284. Axe-head of basalt with elliptical section, slightly tapering neck; chipped flat. The edge is sharpened on one side. Length 14.0. IV B. B 14. 82.4.
285. Chip of grey flint. Length 5.5. IV A. F 14. 83.0.
286. Knife of brown flint with one cutting edge, unretouched; curved neck. Length 6.6. IV B. B 15. 80.2.
287. Flake of grey flint with edges shaped like an arrow-head; projecting tang. Length 5.6. Outside the wall in C 11. 86.0.
288. Chip of grey flint, with roughly retouched edge and tang. Length 5.5. IV B. E 14. 81.5.
289. Pestle of greenstone; broken in many pieces. The shape seems to be that of a truncated cone with concave sides. Length 16.0. IV B. C 15. 81.0.
290. Knife of white flint with one cutting edge; slightly marked tang. Length 6.1. IV B. B 15. 81.0.
291. Fragment of a knife of white flint. Length 4.5. V A. H 17. 82.6.
292. Flat scraper of white flint with rounded, finely retouched edge. Length 4.5. V A. H 17. 83.0.
293. Scraper of white flint with one retouched, rounded edge. Length 5.7. V A. H 17. 82.8.
294. Leaf-shaped knife of grey flint with two cutting edges and marked tang. Length 5.6. V A. H 17. 82.5.
295. Leaf-shaped knife of white flint with nearly parallel edges; finely retouched. Length 6.7. V A. H 18. 82.4.
296. Knife of grey flint with one concave, slightly retouched cutting edge and marked tang. Length 6.8. V A. H 18. 82.4.
297. Scraper of white flint with pointed, roughly retouched edge; stout tang. Length 5.5. V A. H 18. 82.4.
298. Scraper of brown flint; one side concave; the other with midrib; roughly retouched edge. Length 4.0. V A. H 18. 82.2.
299. Scraper of grey flint with one convex and one almost straight edge; one side flat, the other with midrib. Length 5.2. V A. H 17. 82.2.
300. Chip of white flint; long, irregular shape. Length 5.2. V A. H 17. 82.5.
301. Knife of white flint with triangular plan and section; one cutting edge, slightly retouched. Length 7.4. V A. H 17. 83.1.
302. Knife of white flint with one rounded cutting edge; triangular section. Length 8.6. V A. H 17. 82.3.
303. Chip of brown flint with triangular section and one unretouched cutting edge. Length 5.5. V A. H 17. 82.5.
304. Fragment of cylindrical steatite bead broken at both ends. Length 1.7. V A. H 17. 82.4.
305. Knife of brown flint with trapezoid section. Length 6.7. V A. G 17. 82.0.
306. Knife of brown flint with a triangular section; one slightly retouched cutting edge. Length 6.0. V A. G 18. 82.0.
307. Chip of brown flint, one side convex, the other with midrib; trapezoid shape. Length 5.5. V B. G 18. 81.0.
308. Knife of white flint with one cutting edge, finely retouched with zigzag notches. Length 6.2. V A. F 17. 81.2.
309. Pointed scraper of grey flint; one side flat, the other with midrib; triangular shape; two edges slightly retouched. Length 5.5. V A. F 17. 82.6.
310. Knife of grey flint with straight sides; two edges; one side with midrib, the other with two ribs. Length 6.8. V A. F 16. 80.7.
311. Scraper of white, soft flint; one edge retouched. Length 7.5. V A. F 16. 81.6.
312. Piece of a scraper of grey flint; one rounded edge finely retouched all round; one side flat, the other with midrib. Length 4.0. V A. F 16. 81.1.
313. Knife of grey flint, as No. 140. Length 5.0. V A. F 16. 81.3.
314. Pointed chip of grey flint with slightly retouched edge. Length 4.6. V A. F 16. 81.6.
315. Chip of brown flint. Length 3.3. V A. G 16. 82.2.
316. Chip of flint. Length 6.0. V A. G 16. 82.1.
317. Knife of white flint, with triangular section; unretouched edges. Length 6.6. V A. G 16. 83.0.

318. Pointed chip of white flint with triangular section. Length 4.5. V A. G 16. 83.4.
319. Flake of brown flint. Length 3.0. V A. G 16. 83.2.
320. Knife of grey flint with two edges; one side flat, the other with two ribs. Length 8.0. V A. G 16. 83.3.
321. Curved flake of brown flint with one sharp edge. Length 4.1. V A. H 16. 82.8.
322. Knife of grey flint, as No. 9. Length 4.3. V A. H 16. 82.5.
323. End of a stag's horn, broken in three pieces; the top missing, upper part slightly worn. Length 15.5. IV B. B 14. 82.5.
324. Red Polished bowl with flat bottom; slightly convex sides; plain rim; pinched, open spout at side. Buff, gritty clay. Broken in many pieces. Diam. c. 25.0. IV B. B 14. 81.7.
325. Scraper of brown flint; one side flat, the other with midrib; edge retouched. Length 5.5. V A. I 17. 82.6.
326. Flake of grey flint with trapezoid section; one edge slightly retouched. Length 5.5. V A. I 17. 82.4.
327. Scraper of grey flint of trapezoid shape; one side flat, the other with two ribs; one rounded edge retouched. Length 5.6. V A. I 17. 81.9.
328. Knife of red flint with triangular section, nearly parallel, retouched edges; long, stout tang. Length 16.0. V A. H 18. 82.2.
329. Flake of brown flint with one rounded, sharp edge; unretouched. Length 5.0. V A. I 17. 82.2.
330. Flake of white flint of triangular shape; unretouched. Length 4.7. II B. G 10. 88.5.
331. Knife of grey flint, roughly triangular, with two cutting edges; one side flat, the other with midrib; no tang. Length 6.4. II B. G 10. 88.0.
332. Scraper of grey flint with triangular section; slightly projecting tang; edges roughly retouched. Length 8.3. II B. F 10. 88.3.
333. Core of flint. Length 6.5. II B. F 10. 88.4.
334. Core of flint. Length 8.7. II B. F 10. 88.0.
335. Whetstone. Length 7.7. II B. F 10. 88.0.
336. Flake of grey flint; one side flat, the other with midrib; unretouched. Length 7.1. II B. F 10. 87.8.
337. Fragment of elliptical grinder of dolerite with one side convex; the other worn flat. Length 20.0. II A. F 9. 90.0.
338. Scraper of brown flint; one side flat, the other with midrib; one edge retouched. Length 4.6. II B. F 9. 88.0.
339. Knife of grey flint; leaf-shaped, with one side flat, the other with midrib; slightly projecting tang; unretouched. Length 6.0. II B. F 9. 88.0.
340. Small, curved, slightly worn point of horn; used as an awl. Length 2.9. II B. E 9. 87.8.
341. Scraper of dark flint; one side flat, the other with high midrib; roughly retouched edges. Length 5.4. II B. E 9. 88.5.
342. Flat scraper of grey flint, straight, finely retouched edge; wide tang. Length 5.4. II B. E 9. 87.9.
343. Point of horn, as No. 340. Length 2.7. II B. F 9. 88.0.
344. Knife of grey flint with two roughly retouched edges; one side flat, the other with high midrib. Length 5.5. II B. F 9. 88.0.
345. Miniature chisel of green steatite, parallelepipedic, with corners cut off; rectangular section; neck slightly pointed; edge sharpened on both sides. Length 6.0. II B. F 9. 87.9.
346. Scraper of white flint; one side curved, the other with midrib; wide, projecting tang; slightly retouched edge. Length 5.3. II B. F 9. 89.0.
347. Flake of grey flint with one sharp cutting edge. Length 6.5. II B. F 9. 88.3.
348. Chip of brown flint; one side curved, the other irregularly chipped. Length 5.6. II B. F 9. 88.3.
349. Chip of flint. Length 4.5. II B. F 9. 88.3.
350. Grinder of hard, grey limestone. Length 8.5. II B. E 10. 86.6.
351. Two flat, concave whetstones. Length 3.2. II B. E 10. 86.6.
352. Knife of brownish flint, as No. 88, but rather smaller in size. Length 5.7. II B. D 10. 87.0.
353. Scraper of grey flint with two convex edges; one side flat, the other with a high midrib. Length 5.0. II B. E 10. 87.5.
354. Leaf-shaped knife of grey flint; one side with midrib; two cutting edges. Length 6.3. II B. E 10. 88.1.
355. Chip of grey flint with a slightly retouched edge, very thick neck. Length 7.5. II B. E 10. 87.6.
356. Knife of grey flint with two slightly curved edges meeting in a rounded point; one flat side, the other with two ribs. Length 7.8. Outside the wall in B 12. 84.0.
357. Red Polished jug, made up from about 160 pieces; part of the body missing. Long, ovoid shape of gently curving lines with pointed base; concave neck with straight, plain rim. The clay is gritty and of a rather dark brown colour, shading into a buff. Height 59.0. IV B. D 13. 82.5—81.0.
358. Fragment of a knife of brown flint; one side flat; the other with midrib; wide, projecting tang. Length 3.3. V A. H 16. 82.0.
359. Scraper of white flint; one side flat, the other convex with retouched, rounded edge. Length 4.0. V A. G 16. 82.0.
360. Chip of white flint of trapezoid shape, one sharp cutting edge. Length 4.5. V A. H 16. 82.0.
361. Thin scraper of white and brown flint with rounded, very finely retouched edge. Length 5.1. V A. G 16. 82.0.
362. Scraper of grey flint with projecting tang; one side flat, the other with midrib; sharp, unretouched edge. Length 4.7. V A. H 16. 82.0.
363. Scraper of white flint; one side flat, the other convex; rounded, very finely retouched edge. Length 4.7. V A. H 17. 82.0.

364. Scraper of grey flint with trapezoid shape; one side flat, the other with midrib. Length 4.7. V A. H 17. 82.0.
365. Chip of white flint. Length 6.0. V A. G 17. 82.0.
366. Chip of white flint. Length 5.8. V A. G 17. 82.0.
367. Chip of grey flint. Length 5.0. V A. G 17. 82.0.
368. Fragment of knife of grey flint with two cutting edges; one side flat, the other with midrib. Length 4.5. V A. H 17. 82.0.
369. Scraper of grey flint; one side flat, the other with midrib; rounded edge, roughly retouched. Length 5.6. V A. H 17. 82.0.
370. Thin knife of white flint with round, finely retouched edge; point broken. Length 5.0. V A. H 17. 82.0.
371. Chip of flint. Length 4.5. V A. G 17. 82.0.
372. Scraper of grey flint with pointed tang; curved, very finely retouched edge; both sides flat. Length 3.8. V A. G 17. 82.0.
373. Knife of white flint; one side flat, the other with midrib; two cutting edges, slightly retouched. Length 4.5. V A. G 17. 82.0.
374. Knife of white flint similar to No. 373. Length 3.7. V A. G 17. 82.0.
375. Scraper of grey flint with long, projecting tang; irregular edge. Length 6.0. V A. G 17. 82.0.
376. Scraper of white flint of triangular shape; one straight, slightly retouched edge. Length 5.0. V A. F 17. 82.0.
377. Chip of brown flint. Length 5.0. V B. F 17. 79.5.
378. Thin, triangular axe-head of basalt with convex edge and narrow neck. Length 4.8. V B. F 17. 79.5.
379. Red Polished bowl, made up from 89 pieces; part of the base and sides restored. The base is flat and the bowl is almost three-sided; splaying sides; plain rim, very slightly pinched into an open spout. Grey, sandy, coarse clay, almost unbaked. The red polished slip has, in some patches, turned to a mottled black; polish, to a great extent rubbed off. Height 21.0. Diam. 23.5. IV B. D 14. 81.0.
380. Flat, circular bowl of dolerite with thick walls and flattened base. Diam. 8.0. IV B. D 15. 81.0.
381. Fragment of grinder of greenstone; one side worn flat. Length 11.5. IV B. D 15. 81.0.
382. Circular terracotta disc, which crumbled to dust after a few minutes in the open air. Diam. 8.0. IV B. D 15. 80.5.
383. Pestle of greenstone, slightly worn on two sides, tapering towards one end. Broken in many pieces. Length 20.0. IV B. D 15. 81.0.
384. Pestle of greenstone in the shape of a truncated cone; broken in many pieces. Length 14.0. IV B. D 15. 81.5.
385. Axe-head of basalt, as No. 31. Length 11.5. IV B. D 16. 82.0.
386. Elliptical grinder of greenstone; worn quite flat on one side; the other partly worn so that the grinder is now very thin. Length 31.0. IV B. B 14. 81.0.
387. Pestle of basalt in the shape of a truncated cone with convex base. Length 9.2. IV B. C 12. 82.0.
388. Green river-stone: hollowed on one side as a mortar. Diam. 10.5. IV B. C 13. 82.0.
389. Pestle of basalt, as No. 387, but with concave sides. Length 10.0. IV B. C 13. 82.5.
390. Red Polished jug with flattened base, sides convex, and tapering slightly upwards, rather bent-out rim no handle. This jug was found in situ, but the fragments crumbled to powder after a few minutes in the air. Height c. 18.0. IV B. C 12. 83.0.
391. Knife of brown flint with one unretouched cutting edge; flat neck. Length 6.7. IV B. C 13. 81.0.
392. Axe-head of basalt, as No. 31, but with straight sides. Length 9.7. IV B. D 13. 81.5.
393. Knife of brown flint with thick tang and one slightly retouched edge; one side flat, the other with midrib. Length 6.5. IV B. D 13. 81.5.
394. Scraper of blue flint, one side flat, the other with midrib; rounded, finely retouched edge. Length 3.5. IV B. E 13. 81.3.
395. Scraper of soft, white flint; one side flat, the other with two ribs; finely retouched edge. Length 5.0. IV B. D 13. 81.0.
396. Pestle of dolerite, as No. 383. Length 20.0. IV B. E 13. 81.4.
397. Pestle of basalt, as No. 387. Length 10.5. IV B. D 12. 83.0.
398. Scraper of red flint; one side flat, the other with midrib, one long, convex edge, the other straight. Length 7.2. IV B. D 12. 82.7.
399. Scraper of white flint with wide, projecting tang; one side flat, the other with midrib; rounded, finely retouched edge. Length 5.5. IV B. D 12. 81.5.
400. Circular grindstone of dolerite with flat base curved upper side with a small hole bored in the centre. Diam. 10.5. IV B. E 12. 83.0.
401. Scraper of white flint, one side slightly curved, the other with midrib; slightly retouched edges. Length 5.5. IV B. E 12. 82.7.
402. Scraper of white flint with a trapezoid section; one tang-shaped projection at the neck. Length 7.5. IV B. E 12. 82.7.
403. End of a stag's horn, broken in three pieces; tip missing. Slightly worn at the upper end. Length 13.8. IV B. D 12. 82.5.
404. Scraper of red flint with trapezoid section, slightly marked tang. Length 7.5. IV A. C 12. 83.2.
405. Grinder of greenstone, as No. 406. Length 14.0. IV B. E 14. 81.0.
406. Oval, disc-shaped grindstone of dolerite, worn on both sides; notched on one flat short side and the two long sides, partly with a polished, black surface (Idol?). Length 14.0. IV B. E 14. 81.0.
407. Grinder of greenstone, very much worn on both sides. Length 30.0. IV B. D 14. 81.0.
408. Elliptical grinder of greenstone, very much worn on one side; back slightly worn. Length 33.5. IV B. D 15. 81.0.

409. Pestle of basalt, as No. 387. Length 22.5. IV B. D 15. 81.0.
410. Chip of black flint; slightly curved, irregular shape. Length 6.9. IV B. C 13. 81.0.
411. Flat knife of white flint; one beautifully curved edge, finely retouched. Length 6.2. IV B. C 13. 81.0.
412. Idol of green steatite; a seated figure with feet apart and isolinear; body upright, and arms projecting horizontally to the side; the head of the idol is shaped as an oblique disc, pierced by a hole at edge; flat back; lower part of right leg missing. Length 6.4. IV C. E 15. 80.0.
413. Pestle of greenstone; a slightly curved, truncated cone. Length 20.0. V B. F 16. 80.0.
414. Scraper of a brown flint with a triangular section; the rounded edge is finely retouched on three sides. Length 4.5. V B. F 16. 80.0.
415. Scraper of white flint with a trapezoid section; slightly projecting tang; one edge finely retouched. Length 5.0. V B. G 16. 80.0.
416. Scraper of white flint with flat, trapezoid section; slightly marked tang; rough retouchings at the edges. Length 4.5. III D. K 3. 93.0.
417. Triangular scraper of grey flint with a rounded cutting edge, very finely retouched. Length 4.1. III D. K 3. 93.0.
418. Flake of brown flint with one side flat, the other with three ribs. Length 4.1. III D. L 3. 93.0.
419. Chip of grey flint with one very sharp edge without retouchings; slightly marked, projecting tang. Length 4.7. III D. K 3. 93.0.
420. Flake of brown flint with thin edge; triangular shape. Length 4.6. III D. L 3. 93.0.
421. Chip of black flint of triangular section. Length 4.2. III D. K 3. 93.0.
422. Knife of grey flint, as No. 439. Length 8.2. III D. K 3. 93.0.
423. Knife of yellow flint with trapezoid section; two slightly retouched cutting edges. Length 6.0. III D. K 3. 93.0.
424. Scraper of brown flint with trapezoid shape and section; one edge retouched from both sides. Length 7.0. III D. K 3. 93.0.
425. Scraper of white flint with one edge retouched from both sides. Length 3.5. III D. K 3. 93.0.
426. Chip of red flint with triangular section. Length 4.0. III D. J 3. 93.0.
427. Knife of brown flint; one side flat, the other with two ribs; no retouchings. Length 5.0. III D. K 2. 93.0.
428. Pointed, black and white flint chip, with one slightly retouched edge. Length 4.5. III D. K 2. 93.0.
429. Scraper of grey and white flint of triangular shape; part of the edge slightly retouched; projecting tang. Length 3.5. III D. K 2. 93.0.
430. Fragment of a grindstone of dolerite, worn on all sides; elliptical section. Length 13.5. III D. K 2. 93.0.
431. Core of flint. Length 8.0. III D. K 2. 93.0.
432. Knife of green flint; leaf-shaped with two cutting edges; one side flat, the other with two ribs. Length 5.6. III D. K 2. 93.0.
433. Knife of grey flint one side flat; the other with midrib; wide, projecting tang. Length 5.2. III D. K 2. 93.0.
434. Scraper of grey flint of oval shape; one edge retouched on both sides. Length 7.2. III D. L 1. 93.0.
435. Scraper of grey flint, trapezoid shape; thin, wide tang; sharp edges without retouchings. Length 4.2. III D. J 3. 93.0.
436. Chip of grey flint of irregular shape. Length 7.2. III D. J 3. 93.0.
437. Chip of white flint. Length 5.1. III D. I 3. 93.0.
438. Scraper of grey flint; triangular shape; wide tang; one side flat, the other convex; edge all retouched on the convex side. Length 5.0. III D. K 3. 93.0.
439. Knife of white flint; one flat side, the other with a very high midrib; two finely retouched edges. Length 7.1. IV C. E 15. 79.5.
440. Knife of grey flint, one side flat, the other with retouched midrib; one rounded cutting edge, very finely retouched. Length 7.1. IV C. E 15. 79.5.
441. Flat, fish-tailed amulet pierced at one end. The amulet may have been meant as a sacred liver. Slightly damaged on one side, and the string-hole is rather worn. Length 2.9. Found by Miss du Plat Taylor c. 300 m. south of the settlement, together with Neolithic sherds of pottery.
442. Red Polished bowl made up of 26 sherds from Layer IV B; one side damaged; buff, gritty clay fired right through; the colour on the surface varies from dark-grey to light-buff; the polished slip is a shade of brown. Deep bowl with flat bottom; almost straight, splaying sides; plain, straight rim, very slightly depressed for an open spout. Height 11.8. Width 18.5.
443. Fragment of a Red Polished jug; long, ovoid, with gently curving lines, made up of 16 pieces, from Layer IV B. Probably of the same shape as No. 357, though the pointed base and neck are missing. The clay is gritty and the surface, buff coloured. Height 12.5.
444. Fragment of a Red Polished vase made up of 44 pieces from Layer IV B. The inside seems not to have been treated as a bowl, and in the upper parts, the fragments are so much bent in, that it should be restored as a jug. The shape, however, is very irregular; one side is nearly vertical; and the opposite side is rather projecting. The base may have been flat or pointed. None of the upper part is preserved. The clay is gritty, buff in colour; surface varies from light-red to grey-black. Height 35.0.

SURFACE FINDS

445. Axe-head of grey river-stone; slightly irregular shape with narrowed neck; one side flat; the other convex; roughly sharpened edge. Length 10.4.
446. Polished axe-head of greenstone; short, narrow neck with flat top; rounded, wide edge; elliptical section in the middle. Length 6.3.

447. Fragment of an axe-head, as No. 445. Length 8.5.
 448. Scraper of white flint; one side flat, the other convex; rounded, finely retouched edge. Length 3.8.
 449. Scraper of grey flint with wide, projecting tang; rounded, finely retouched edge. Length 4.3.
 450. Fourteen knives of various flints, usually flat, or triangular in section, with one rounded cutting edge unretouched or retouched, usually a slightly projecting tang, and flat base. Length 3.7 — 6.8.
 451. Seventeen knives of various flints, usually grey, with one side flat and the other with midrib or flat ridge; two unretouched cutting edges; in some specimens, a projecting tang is noticeable. Length 3.6 — 7.5.
 452. Four arrow-heads of flint more or less of rhomboid section, with retouched sides; in two specimens, a projecting tang; elliptical shape. Length 2.2 — 3.5.
 453. Four flat and pointed arrow-heads of flint of triangular shape, with projecting tang. Length 2.4 — 3.1.
 454. Flat, polished stone, broken at one end; the other of elliptical shape. Length 2.6.

VARIOUS UNNUMBERED FLINTS, FROM DIFFERENT LAYERS

- Layer I A. Scrapers of white flint with finely retouched edges, usually of trapezoid or triangular shape, often with projecting tang; lancet-shaped knives with one side flat, the other with midrib; one cutting edge unretouched; three arrow-heads of grey, or brown flint with triangular sections; finely retouched edges, and sharp points. Length 3.2 — 5.1.
 Layer I B. With exception of a few scrapers with retouched edges, mere chips of white or grey flint.
 Layer II A. Two scrapers of grey flint; one flat; the other with one convex side; both of oval shape with wide, stout tangs, beautifully rounded, retouched edges. Fragments of other scrapers with retouched edges; a long arrow-head with triangular section and rather irregular shape. Length 5.0.; triangular, flat arrow-head with sharp, retouched edges. Length 2.5.; two short knives of grey flint, with projecting tangs; many chips of various flints.
 Layer II B. Two flat scrapers of white flint with retouched, rounded edges and wide tangs; one leaf-

shaped knife with two ribs and finely retouched edges; various fragments of scrapers and knives of the usual types; one arrow-head of white flint with retouched edges; many chips of various flints.

- Layer III A. Fragments of scrapers with rounded, finely retouched edges; one knife of white flint with flat base and finely retouched cutting edge; many chips.
 Layer III B. Chips of flints of various kinds.
 Layer III C. Two knives with triangular sections and flat base, slightly projecting tangs; edges not retouched; chips of various flints.
 Layer III D. Scrapers of grey or white flint, sometimes with long projecting tangs and unretouched edges; one knife with curved base and sharp cutting edge; one knife with triangular section and projecting tang; chips of various flints and fragments of other flint tools.
 Layer IV B. Six leaf-shaped knives with high midribs and slightly projecting tangs; no retouchings. Length 4.0 — 6.0.
 Layer V A. Seven scrapers of white and grey flint more or less of triangular shape with long projecting tangs and rounded, finely retouched edges. Length 3.1 — 5.5. Eight scrapers of oval shape without tangs, and finely retouched, rounded edges; one knife with parallel sides; one side flat, the other with midrib, well marked tang. Length 6.9. Ten knives of grey, or white flint with flat base and one cutting edge slightly retouched; usually, a well marked tang; knife of grey flint with triangular section, well marked tang. Length 4.8. Two chips of grey flint probably used as arrow-heads; irregular shape. Length c. 2.5. Arrow-head of white flint with trapezoid section. Length 3.0.
 Layer V B. Three long scrapers with one flat side; projecting tang; finely retouched edges. Length 3.9 — 5.9. Three thick scrapers without projecting tang, finely retouched edges. Knives or fragments of knives, of grey flint with one flat side, the other with midrib; sometimes with projecting tang, one or three unretouched edges. Length 3.6 — 7.1. Various chips of flint.

CLASSIFICATION OF FINDS

All the flint tools are made from lumps of flint, found in the limestone rock of the hills, many of which were found in the settlement during the excavation. The shapes of the flakes vary considerably, owing to the different methods of working the flint: and they were usually used as tools just as they happened to be shaped, or only with very small alterations and retouchings. For this reason, it is very difficult to fix any definite types, and only those can be taken into consideration which are really worked by subsequent

chipping into special tools such as scrapers, knives, arrow-heads etc. Usually the subsequent retouchings are confined to the edges, which are nearly always struck from one side only: the retouchings of the edges are often of wonderful workmanship. Sometimes a tang projects slightly for fixing the tool to a handle, and is marked out by notches on the sides: this is seen both on the scrapers, and on the knives.

The scrapers are usually of oval, or rather triangular shape with the cutting edge slightly curved. One side of the scraper is flat and not retouched, the other, from which the edge is worked, has one or two ribs, or is roughly convex. Sometimes the whole piece is slightly curved according to the original shape of the flint.

The knives are usually slightly curved in the same way and have one flat side, and one with a midrib: both double and single edged knives are represented. Occasionally the edges of the knives are retouched, and then, the edge is shaped to a gentle curve made by retouchings from one side only; more often, a sort of tang is attempted or is shown by notches on both sides of the knife. This tang was probably intended to be put into a handle of wood, or bone.

The arrow-heads are made of small chips, of two types: 1) a long, pointed, leaf-shape, with finely retouched edges and triangular section; 2) a short, flat, triangular or heart-shape, sometimes provided with a roughly marked tang. These types depend largely on the shape of the chips from which they are made.

Numerous pottery fragments were found, but no distinct differences with regard to the burning of the clay, shapes and treatment of the surface could be noticed on the pottery of the different strata. All the pottery can therefore be considered as belonging to a continuous series of vases, which vary very little at the beginning and end of the period. The pottery consisted of the following classes:

- I. Red Polished Ware.
- II. Plain White Ware.
- III. Painted Ware.

In all the strata a large number of sherds were collected which because of the rough clay and the worn surface, could not be allotted to any particular class. Probably, most of them were either of Red Polished, or simply, a Coarse Ware.

I. Red Polished Ware.

Technique.

The clay is usually soft, gritty and mixed with small stones, which sometimes are as large as the thickness of the sherd. Traces of small vegetable stalks are often noticed, especially in the clay of large vases. Owing to the different degrees of fire, the colour varies very much. Usually, it is reddish brown or buff, but not infrequently, dark, or nearly black. Only the thinnest vases are fired right through; the centre part is often black and the outer surfaces light brown, especially in the larger jugs and the thick bottoms of the bowls. — The clay is washed over with a thin, silted wash, covered by a red polished slip. The wash is usually of a buff colour and flakes off easily. The slip is often darker in colour

than the wash and sometimes mat: it, too, flakes off easily, so that sometimes only small patches of it remain. The bulk of the pottery described as Coarse Ware may have had a red slip, which has now entirely disappeared. The colour of the slip often varies on same vessel, so that sherds of different colour can belong to the same vase: also, if the red slip has flaked off, it is very difficult to separate the sherds from those described as Plain White Ware.

Shape.

The bulk of the sherds are broken in very small pieces so that it is difficult to make out any exact shapes. In seven cases, however, so many pieces of the same vessel were found that more or less complete vases could be reconstructed; these were open bowls with flattened bottom, splaying, straight or slightly convex sides, and straight, plain rim, sometimes with slightly pinched spout. The bowls are often slightly irregular in shape owing to accidents during the firing.

Another type of bowl has a flat bottom, the outside of which is pinched into a sort of moulded plinth. This is most common on the large bowls which are usually plain without handle or spout. Only one fragment with a tubular spout near the rim has been noticed. Rarely small knobs are used as stands for the bowls, probably a tripod base, and two specimens of a handle in the shape of a vertical projection without string-hole were noted on fragments of bowls. The jugs preserved are of two shapes: one, a large, ovoid jug with pointed base and slightly convex neck with plain, splaying rim; without handle: the other is sack-shaped and has a flattened bottom, slightly convex sides tapering upwards with plain, slightly bent-out rim; also without handle. This type is of small size.

Decoration.

As a rule this ware is entirely undecorated. On a few specimens, however, one or two incised, encircling lines were noted on the outside of bowls.

II. Plain White Ware.

Technique.

The clay of this ware is similar to that of the Red Polished Ware, and is covered by a light red or buff slip usually thicker than the wash of the Red Polished ware. Rarely, the surface is more or less polished, a treatment which may have been more common than can be proved from the now much damaged sherds.

Shape.

As far as can be ascertained, the shapes represented seem to be the same as those of the Red Polished ware, but no complete vessel is preserved: fragments of bowls and jugs are represented.

Decoration.

The ware is undecorated.

III. Painted Ware.

Technique.

The clay is similar to the preceding wares: like the Plain White ware, it is usually covered by a thick slip, light brown or buff in colour. On this slip the ornaments were painted with a thin, red or yellow paint, usually mat. The paint itself has sometimes flaked off, and can now only be traced on the slip below.

Shape.

The shapes are uncertain, but have probably been of the same as of the preceding wares.

Decoration.

The few decorative elements represented are wide bands, and, in one case, cross lines. A fragment of a bowl had an encircling line below the rim.

RELATIVE CHRONOLOGY

The following diagram (see pp. 300, 301) shows the distribution of finds between the various layers. The layers are designated as above.

The diagram shows that in general there is little difference between the various strata as far as concerns the finds. Of the pottery, the different wares are almost equally divided between the strata. Below Floors IV B and V A, however, no pottery was found. The complete Red Pol. vases were all found on Floor IV B; apparently owing to the fact that this hut was burnt and the later floor laid over the objects on the floor. On the same floor, the axe-heads, grinders, and pestles were comparatively numerous. On the contrary, however, the flint tools and even the chips of flint were rare in the earlier, lower layers belonging to Hut IV. The flints were frequently found in all higher layers, especially above the floors: they were entirely lacking in the stratum IV C, but occasionally found in IV B and IV A. The same is noted in connection with Hut V, where comparatively few flints were collected below the floor, while a relatively large number of them was found above the floor (V A). All the strata of Hut III are comparatively late, and it is evident that the difference of frequency of the flints above mentioned, cannot here be noted as in Huts IV and V. The lack of flints in the earlier strata of the settlement might be explained by the difficulty in finding the raw flint during the first occupation of the Neolithic village.

ABSOLUTE CHRONOLOGY

An absolute date for the settlement at Kythrea can only be given by a comparison with the Neolithic settlement of Lapithos. The architectural remains of the western settlement there are different to those of Kythrea, but if we compare the pottery and the axe-heads,

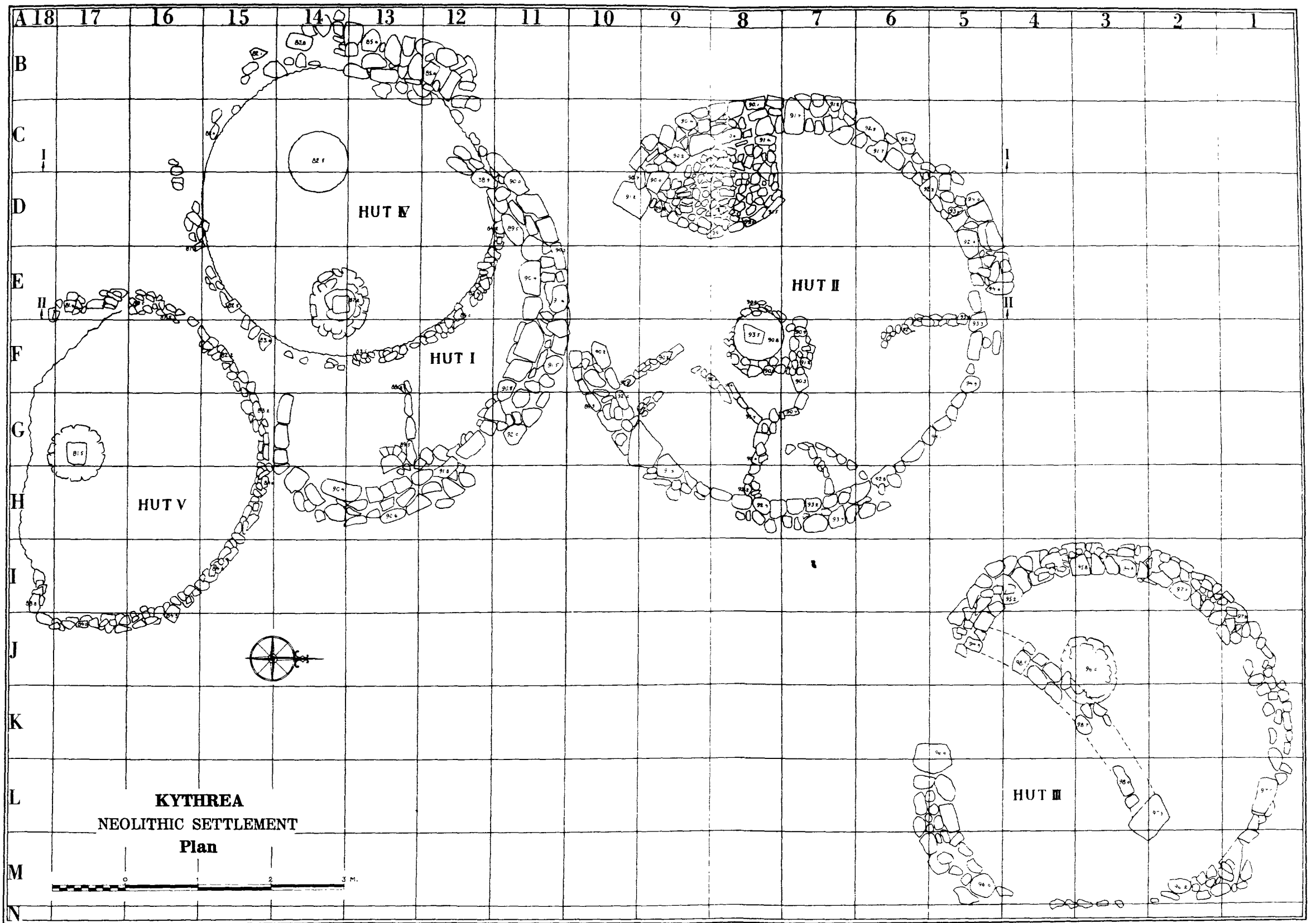

1

Sections

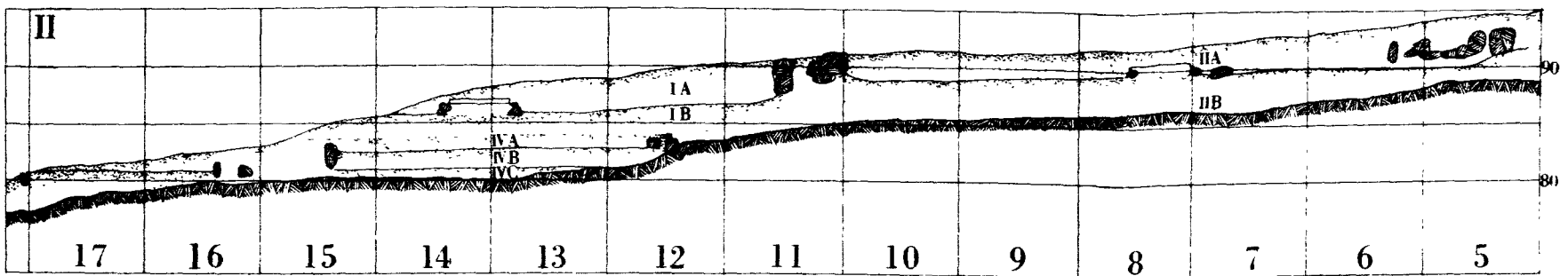
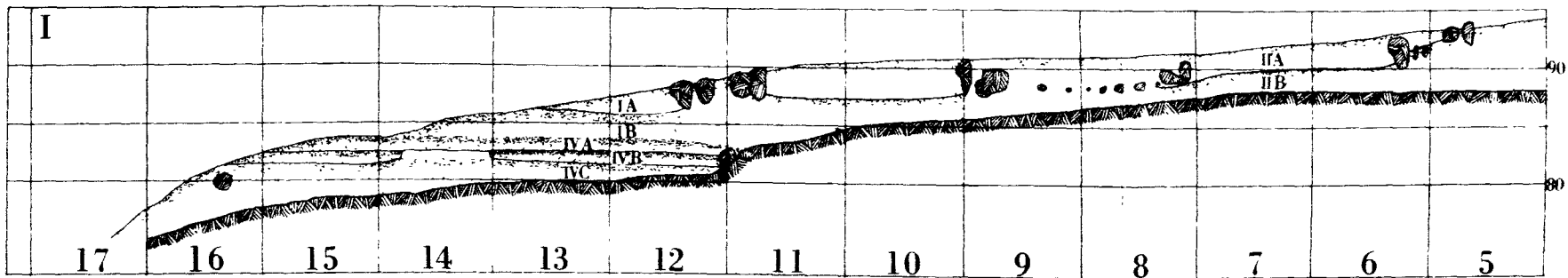

2



the similarities are striking. The technique of the pottery of Kythrea is exactly the same type as that of the western settlement pottery of Lapithos, which (p. 33) has been assigned by Gjerstad to the end of the 4th millenium B. C.

Perhaps, however, the Kythrea culture can be considered as earlier, for the White Painted and Plain White Wares are more often represented there than in the western settlement of Lapithos.

A. W.

the similarities are striking. The technique of the pottery of Kythrea is exactly the same type as that of the western settlement pottery of Lapithos, which (p. 33) has been assigned by Gjerstad to the end of the 4th millenium B. C.

Perhaps, however, the Kythrea culture can be considered as earlier, for the White Painted and Plain White Wares are more often represented there than in the western settlement of Lapithos.

A. W.

Period	Pottery					Flints				
	Stratum	Sherds				Chips and flakes	Scrapers	Knives	Arrow-heads	
		R. P.	R. P.	Pl. Wh.	P. W.					Cores
1	IV C							439, 140 -2		
	V B				307, 377 -2-23*=25	414, 415 -2-10*=12		-16*		
2	IV B	324 357 379 390 442 444 -7	7 18 2		288, 410	394, 395 402	398, 399, 401	286, 290, 391, 393, 411		
	IV A		112 21		111-113, 116 118, 285 -6	115, 117, 119, 404 -4	100, 114, 120, 199 200 259, 260	-7		
	I B		148 74 3		179 50, 90, 175, 180, 182, 261 184, 243, 246, 278 -2 -10-73*=83	46, 174, 176, 178 181 186-189, 192, 241, 244 277, 279 -13-6*=19	173, 177, 185, 242, 245	-5-4*=9		
3	V A		136 14		16, 22, 203, 300, 303 314, 315, 316, 318, 319 321, 326, 329, 360, 365 367, 371 -18-38*=56	21, 52 53, 282, 292 293, 297-299, 309, 311 312, 325, 327, 359, 361 364, 369, 372, 375, 376 -23-26*=49	23, 51, 201, 202, 204 291, 294-296, 301, 302 305, 306, 308, 310, 313 317, 320, 322, 328, 358 368, 370, 373, 374 -25-25*=50	-4*		
	II B		12 5 1		333 43 - 45, 61, 96, 264 334 275, 330, 336, 347-349 355 -2 -13-55*=68	42, 62, 205, 208, 209 220, 222, 224, 266-268 332, 338, 341, 342, 346 353 -17-11*=28	207, 269, 276, 331, 339 344, 352, 354	38 -1		
	III D		10		431 418-421, 426, 428, 436 437 -1 -8-18*=26	416, 417, 424, 425, 429 434, 435, 438 -8-3*=11	422, 423, 427, 432, 433	-5-7*=12		
	III C		20 3 2		103, 226-229, 232, 237 238, 258 -9-42*=51	225, 231, 235 236, 239 247-249 -8	230, 233, 234, 240, 250 257 -12-2*=14			
4	II A		185 45 8		162 18, 19, 28, 29, 34 36, 56, 58, 60, 63 66, 68, 70-72, 92 167, 170, 210 213, 215	5, 6, 13, 17, 30 40, 67, 93 101, 161 165, 166, 171, 172, 198 211, 212 217-219, 270 271, 273, 274 -24 -24*=48	20, 33, 39, 59, 69 163, 164, 214, 272	97 -9-12*=21 -1-1*=2		
	I A		45 22 2		7, 14, 25, 26, 48 49, 121, 122, 123, 127 129, 135 -12-73*-85	11, 12, 24, 27, 98 128, 131-134 -10-32*=42	4, 8-10, 47, 104 124, 125, 130 -9-16*=25	15, 126 -2-3*=5		
5	III B		18 30		73-77, 79-81, 83 84, 86, 89, 137, 139 141, 142, 144-149, 153 155, 157, 159, 191, 193 -28-15*=43	78, 95, 136, 138, 143 151, 154, 156, 158, 160 169, 192, 195 -13-5*-18	82, 85, 91, 140, 168 194	150 -6-2*-8 -1		
6	III A		19 7 3		109, 190 -2-30*=32	106 -1-6*-7	107, 108, 110 -3-2*-5			

* Stray finds unnumbered.

S t o n e										B o n e	
Chisels	Axe-heads	Whet-stones	Mortars	Grinders	Pestles	Lid	Bead Steatite	I d o l s		Awls	Handle
								Steatite	Marble		
								412			
								-1			
	378				413			283			
	-1				-1			-1			
	284, 385		380, 388	381, 386, 400	289, 383, 384					323, 403	
	392			405, 406	407, 387, 389, 396						
				408	397, 409						
	-3		-2	-7	-8					-2	
								304			
								-1			
105, 345	41	221, 265		206, 350	216					263	340, 343
		335, 351									
-2	-1	-4		-2	-1					-1	-2
				430							
				-1							
								102			
								-1			
	31	37		337						57	223
	-1	-1		-1						-1	-1
3					55, 99	54					
-1					-2	-1					
				152							
				-1							

A J I O S J A K O V O S

The Necropolis of Melia

INTRODUCTION

In his Topography,¹ Gjerstad mentions a tomb-field some 1.5 km. east of the village of Ajios Jakovos, situated about 22.5 km. north of Famagusta. The locality is called Melia. He collected on the ground potsherds of Black Slip, White Painted and Red-on-Black Wares: several tombs had been opened and sacked during clandestine excavations, but archaeological investigations had never been carried out on the site.

The burial ground is an almost flat, poorly cultivated plain. Its fields bear more thistles than barley; and in the western borders of the region small pine-trees, *schinia* bushes and thyme, cover the ground close to a ravine, which bounds the site towards the more fertile fields of the village. Some 100 m. north of the place the ground rises gradually to the village of Mandres, situated about 1.8 km. distant, at the foot of the Kerynia Mountains.

The natural rock consists of the usual sedimentary limestone, called by the natives *chavara*, but it contains in this region a certain amount of sand. Its colour is light yellow, and its consistency is eminently suitable for the cutting of rock tombs. So far as the field was investigated, the rock was of the same homogeneous nature, and the cutters of the tombs were, consequently, not bound by any special local conditions, when shaping the tomb; for which reason their typology is of a special interest.

When our operations began at the end of June, 1929, we found two tombs entirely excavated by illicit diggings. They are marked on the field-map (Plan V, 3) by the letters A and B. Fourteen new tombs were opened during the seven weeks of work, and at the same time the cult place at Dhima was unearthed. The tombs were numbered 1 to 14, but for reasons that will be put forward in the following pages, Tombs 2, 3, 5, 9, and 11 were not completely excavated.

TOMB 1 (Figs. 119: 1—4; 122)

	SIZE			
	Length	Width	Depth	Height
Dromos	3.93	1.22	1.97	—
Stomion	0.81	0.51	—	0.57
Chamber	3.27	4.00	—	0.95

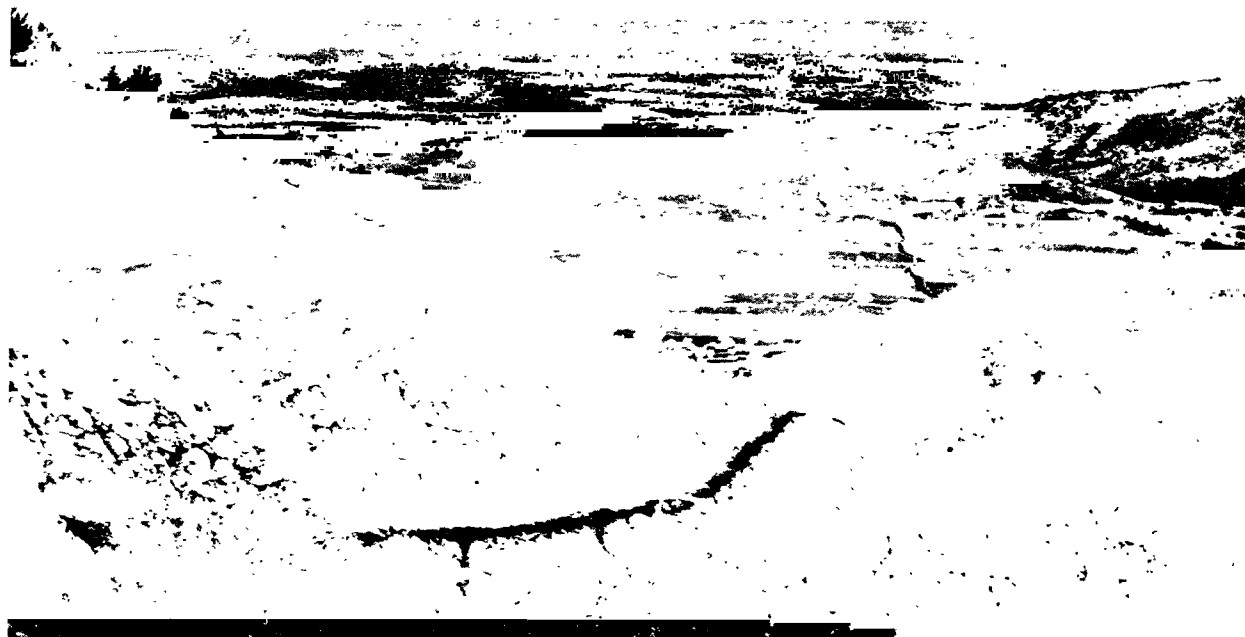

Fig. 118. Ajos Jakovos. View from the Kerynia Mountains. The necropolis is situated to the left of the hillock in the centre.

SHAPE

The dromos is a narrow passage with perpendicular sides. It widens gradually towards the entrance, and reaches its deepest point in front of the stomion. In the back part of the dromos two long steps are roughly cut in the rock, and the front consists of a sloping, rectangular area. The door is a small, oval hole and the stomion is a narrow, gently sloping tunnel, leading down to the level of the chamber floor. The door was closed by a thin, rectangular slab of local limestone, standing on the floor of the dromos and reaching exactly to the top of the stomion. In front of this slab was a thicker stone standing on a slightly higher level and covering the upper part of the doorway (see Stratification).

The chamber is an irregular oval in shape, and the entrance is asymmetrically placed in the left half. The floor sinks gradually towards the back wall, and its surface is rather rough. Around the walls are five shallow niches: four of them are slightly raised above the floor and enclosed by a low partition; the fifth, lay on the level of the floor, and was bounded by three stones. The roof is flat and low, but remarkably well preserved.

STRATIFICATION

The dromos-filling consisted of four layers of pure, broken *chavara*, stratified somewhat obliquely and sloping gently towards the entrance of the chamber. The bottom layer was considerably harder than the rest of the filling, and its upper surface was compact, like a

trodden floor: on this the second door stone was founded. The layer contained a roughly rectangular stone, similar to those found in front of the fifth niche, a large amount of potsherds, and one complete bowl. The majority of the sherds were Black Slip I—II Ware and Plain White Hand-made Ware, mixed with a considerable amount of Red Polished IV, Red Slip and Black-on-Red Wares. The painted specimens were very few, and no wheel-made ware was found. This layer represents, apparently, a clearing out of the chamber, its upper surface serving afterwards as the floor of the dromos. Inside the chamber the stratification was very simple. Chamber and niches contained a homogeneous layer of culture earth and clay, which was dry when found, but showed clear traces of having silted in. On top of this lay, here and there, heaps of debris fallen from the roof, and finally, a fan-shaped layer of fine *chavara* inside the door. This had intruded from the stomion. On the floor, and in the bottom layer, lay all the tomb-gifts. In a heap to the right of the entrance, on top of the silted layer and partly covered by rock debris, were found masses of skeletal remains. They were, without doubt gathered from all parts of the chamber and piled up in connection with preparations for a secondary burial. No bones were found in any other part of the tomb. The pots that were found in the chamber were all of small size and hidden by the thick bottom layer, and had therefore, escaped the attention of the people who cleared the tomb. Contents and stratification showed, however, that no secondary burial was ever made.

BURIALS

It is obvious, that nothing can be said about the burial customs as the skeletal material was not *in situ*; but a rough calculation shows that the number of bodies buried in the chamber was about ten or twelve.

FINDS (GROUP: PL. LX, I; TYPE: L. OF PL. II)

1. Red Polished IV shallow bowl with round base, and almost conical outline. A small, impressed line around the edge, and a knob pierced by a string-hole below it. Diam. 14.0. Floor.
2. Red Slip depressed, spherical jug with round base; concave neck; splaying rim, and handle from rim to shoulder. Rim chipped; handle missing. Mottled surface. Height 5.9. Floor.
3. Red Polished IV bowl, as No. 1. Diam. 10.3. Floor.
4. White Painted IV small, circular bowl with horizontal handle on rim. Wavy lines crossing the bottom, both within and without; transverse lines on handle, and a thin line on rim. Diam. 9.2. Floor.
5. Black Slip I wide, sack-shaped jug with vertical rim, and a horizontal handle on rim; handle and piece of rim missing. Height 11.1. Floor.
6. Red-on-Red shallow bowl with round base, and a thick, semicircular handle from rim to body. Light pink, lustrous ground, and groups of purple, wavy lines from rim to bottom. Decoration inside similar, but obliterated; one third of the bowl missing. Diam. 20.3. Floor.
7. White Painted IV bowl, as No. 4, but without a line around rim. Handle missing. Diam. 10.0. Floor.
8. White Painted IV bowl, as No. 4, but with a loop-handle on rim. Diam. 9.2. Floor.
9. White Painted IV bowl, as No. 8. Diam. 8.7. Floor.
10. Red Slip pear-shaped jug with tall, cylindrical neck; flattened base; oblique mouth, and a narrow groove from rim to top of handle. The handle is adorned with a zigzag line and a dot; part of neck missing. Height 18.5. — 40.
11. Red-on-Black shallow bowl with round base; slightly pinched rim, and a horizontal loop-handle at rim. Groups of wavy lines from rim to rim, meeting at right angles on base; the same decoration within and without. Transverse lines on handle. Rim chipped. Diam. 17.5. Floor.
12. Red-on-Black bowl, as No. 11. Diam. 7.8. — 35.
13. Red Polished IV pear-shaped miniature jug with round base; slightly concave neck; somewhat oblique mouth, and a high, thick handle from rim to shoulder. Height 7.9. — 30.

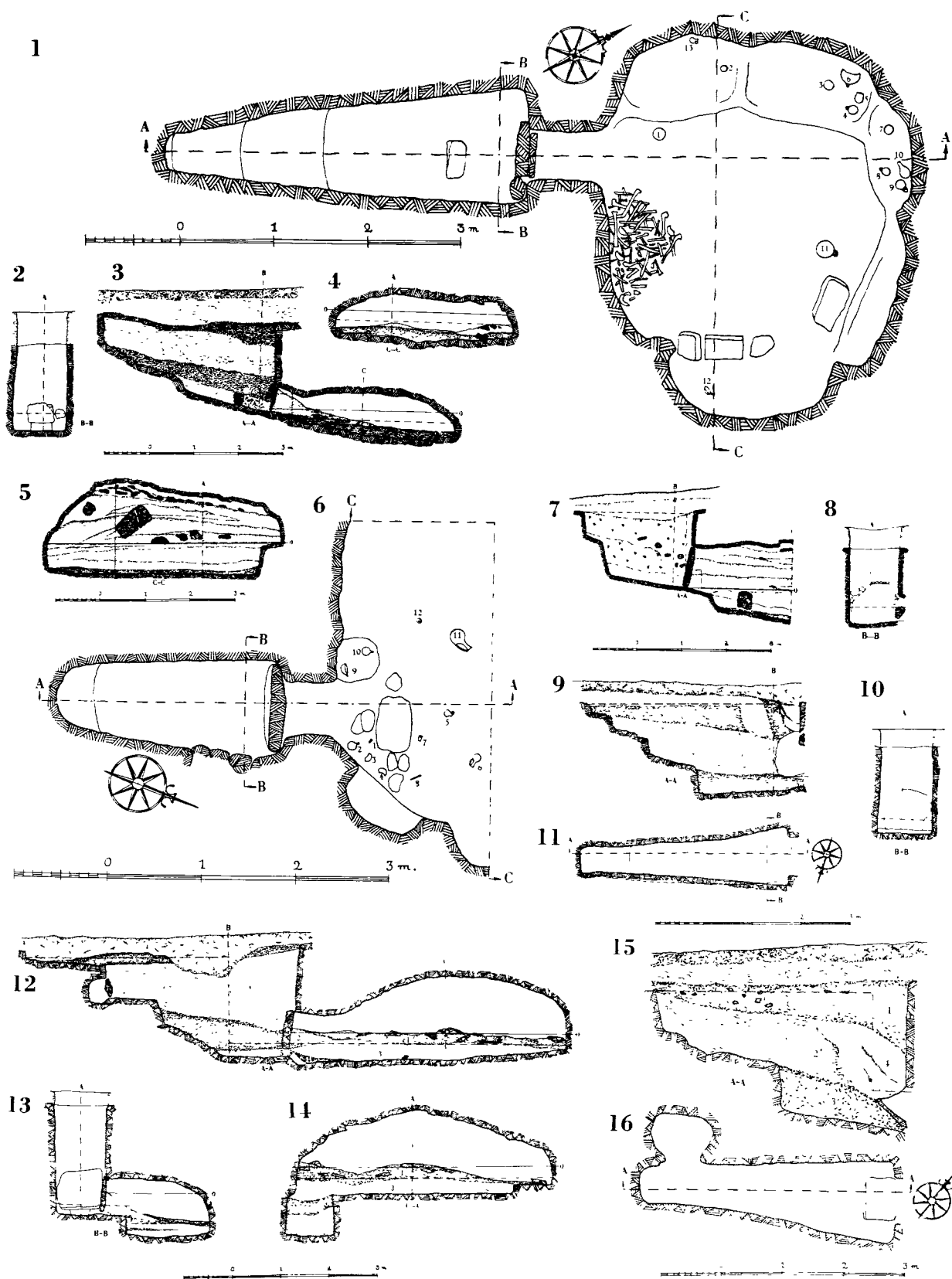

Fig. 119. Aghios Jakovos. Tomb 1, Plan (1); Sections B-B, A-A, C-C (2, 3, 4). Tomb 2, Section C-C (5); Plan (6); Sections A-A, B-B (7, 8). Tomb 3, Sections A-A, B-B (9, 10); Plan (11). Tomb 4, Sections A-A, B-B, C-C (12, 13, 14). Tomb 5, Section A-A (15); Plan (16).

Summing up the Object Register, we obtain the following diagram:

P o t t e r y						
R. P. IV	R. Sl.	R.-on-R.	R.-on-Bl.	Bl. Sl. I	Wh. P. IV	
1. 3, 13 -3	2. 10 -2	6 -1	11. 12 -2	5 -1	4. 7. 8, 9 -4	

CHRONOLOGY

The potsherds in the dromos and the contents of the chamber are, as shown by the diagram and analysis, of largely the same types and proportions. This emphasizes their contemporaneity, and proves that the explanation given above, concerning the partial clearing of the tomb, must in essential parts be correct.

The contents of chamber and dromos all concur in dating the tomb to the Middle Cypriote III period. The Plain White Ware of the dromos and some very advanced Red Slip sherds assign the tomb rather towards the end of the period.

TOMB 2 (Figs. 119: 5—8; 121; 123)

SIZE

	Length	Width	Depth	Height
Dromos	2.48	1.03	1.74	—
Stomion	0.60	0.55	—	0.93

SHAPE

The dromos is an oblong shaft widening towards the door with a straight face, and a semicircular back end. The corners are rounded, the sides perpendicular, and the rounded end provided with a narrow step to facilitate entrance to the shaft. The floor of the dromos slopes gradually towards the entrance of the chamber. The door-packing consisted of a massive slab of calcareous stone, wedged by chips of local rock. The left, or north-eastern, long side of the dromos was pierced by a hole, leading into an adjoining tomb and purposely blocked by some stones and rock debris. The neighbouring tomb was not excavated as it could be satisfactorily stated that its archaeological value was nil (cf. below). The door stone of our tomb was *in situ*. The stomion is a narrow tunnel with a slightly sloping floor, and ends in a low step leading down to the chamber floor. Because of the extremely unfavourable stratigraphical conditions, the chamber was never completely excavated. The shape could, therefore, not be ascertained. The area excavated showed a gently sloping floor, an asymmetrically placed door, and rounded outline of the chamber. On the right of the door were two small niches, about 0.70 m. above the floor. They cannot have served as burial places — their size being too small — and it seems probable that they have been used as cupboards for tomb-gifts. To the left of the entrance was a shallow, circular pit cut into the rock floor.

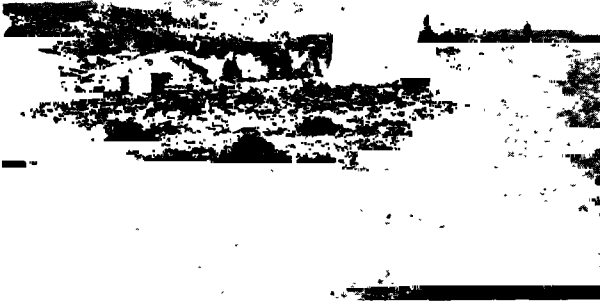

Fig. 120. Ajios Jakovos. Melia.

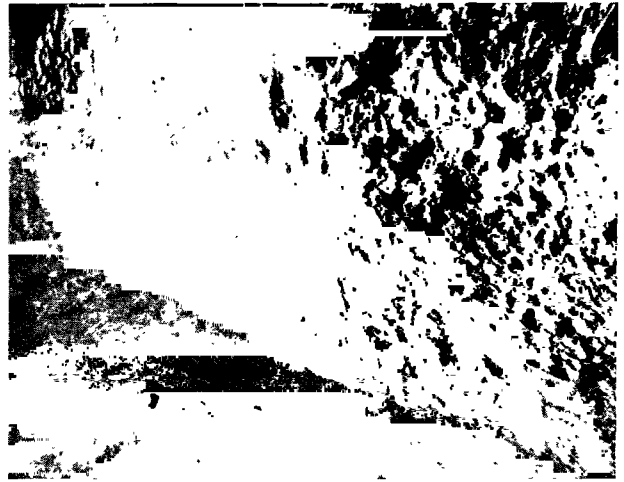

Fig. 121. Ajios Jakovos. Tomb 2. Interior view, showing Section C-C.

STRATIFICATION

The dromos-filling consisted of three layers, besides the two surface layers. They were, from the top, as follows:

- 1) A dark stratum of clayey earth frequently mixed with stones and *chavara* fragments. This layer deepened abruptly in the front part of the dromos and covered both the door stone of the chamber and the hole in the wall to the adjoining tomb.
- 2) A horizontally stratified layer of loose *chavara* mixed with pieces of rock. It started from the level of the step in the semicircular end of the dromos, and was cut through by Layer 1 in front of the door.
- 3) A hard packed stratum of pure *chavara* lying directly on the floor.

Layer 3 is, apparently, a remainder of the original dromos filling, which, on the occasion of a secondary burial, has been removed and partly replaced by Layer 2. Finally the latter has been dug through in later times and the adjoining chamber entered and sacked through this hole. The robber pit was dug at a time when the natural rock was bare, as the two surface layers were intact, and points to a rather remote date.

The chamber was filled to the roof by extraneous earth which was stratified in four thick, silted layers of clay, containing chunks of rock fallen from the roof. Below these layers followed an also silted stratum of dark clay containing small stones, and finally a wet layer of culture earth resting on the floor. It is obvious, that all this earth cannot have intruded through the sealed door-packing; consequently, there must be communication between the chamber and the surface of the earth somewhere else, and it seems probable that the tomb was entered in ancient times in this way and sacked. A quarter of the chamber was excavated and that part of the tomb showed a very deplorable state of preservation. Smashed pottery and fragmentary skeletal remains were found in all the layers without any order, and pieces of the same pot in different layers. The excavated part of the chamber yielded pottery enough to give a fairly good idea of the date of the tomb.

FINDS (GROUP: PL. LX, 2; TYPE: L. OF PL. II)

1. Short whetstone of black stone, pierced from the top to the side. Length 4.3. Width 1.7. — 8.
2. Bowl of Composite Ware (Black Slip and White Painted IV) with a horizontal loop-handle below rim. Oblique strokes radiating from the centre inside the bowl. Diam. 9.8. — 5.
3. White Painted IV bowl, as No. 2. Black, crossed lines within and without. Damaged. Diam. 10.3. — 2.
4. White Painted IV bowl, as No. 2; decorated as No. 3. Half the bowl missing. Diam. 10.5. — 12.
5. Red Polished IV spherical jug with round base; concave neck, and a high, thick handle from rim to shoulder. Damaged. Height 9.8. Floor.
6. Red-on-Black spherical jug with tall, narrow neck; splaying rim, and handle from rim to shoulder. Groups of horizontal, red lines on the neck, forming an irregular chess-board pattern. The decoration on the body is the same, but much worn. Height 15.8. Floor.
7. Loom-weight in the shape of a squat truncated pyramid, pierced horizontally at the top end. Length 4.8. Floor.
8. Tapering bronze pin with "mushroom head", and an eyelet in the middle of the shank. Broken into two. Length 12.3. Floor.
9. White Painted IV bowl, as No. 2. Wavy, black lines, crossing the bottom, both within and without. Transverse lines on handle. Diam. 9.7. Floor.
10. Red Polished IV hemispherical bowl with a horn-shaped string-hole projection below rim. Diam. 9.8. Floor.
11. Red-on-Black jug, as No. 6. Vertical bands of short, horizontal lines on neck and body; a broad, horizontal band around belly; two groups of vertical, crossed lines on bottom. Rim and part of the body missing. Height 26.8. Floor.
12. Spherical mace-head of hard, black stone pierced by a tubular hole through the centre. Diam. 5.9. Floor.

Summing up the Object Register and distributing the finds among the different classes, we obtain the following diagram:

P o t t e r y				Bronze	Terracotta	S t o n e	
R. P. IV	R.-on-Bl.	Wh. P. IV	Composite Ware	Pin	Loom-weight	Whetstone	Mace-head
5. 10	6. 11	3. 4. 9	2	8	7	1	12
-2	-2	-3	-1	-1	-1	-1	-1

CHRONOLOGY

Although the excavation was never completed, the tomb can be safely dated to the Middle Cypriote III period. The potsherds in the dromos, and the fragments found inside, all agree with the finds described above.

TOMB 3 (Fig. 119: 9—11)

SIZE

	Length	Width	Depth
Dromos	4.37	1.16	1.81

SHAPE

Of this tomb only the dromos was excavated. It was of the same type as Tomb 1: a long, tapering passage with perpendicular sides and face, and steps at the back end. The area in front of the stomion sloped gently backwards. The ground plan of the dromos showed a figure with rectangular corners, but at the surface of the natural rock, the plan was of the usual type with rounded corners.

The entrance was widened by later cuttings, and no door stone covered the stomion.

STRATIFICATION

The dromos stratification gave clear evidence that the tomb had been sacked in modern times. From the surface of the earth, a shaft was dug through two intact layers of dromos-filling, right down to the entrance. The door stone had been removed, and the chamber entered and sacked. As the shaft was dug from the present surface of the earth and was filled with field earth of loose consistency, the robbery must have taken place comparatively lately.

CHRONOLOGY

The intact layers of the dromos contained the following potsherds:

	R. Pol. III	R. Pol. IV	R. Sl.	Bl. Sl. I-II	Red-on- Bl.	Red-on- Red	Light- on-Dark	Wh. P. IV	Pl. Wh. Hand- made	Pl. Wh. Wheel- made	R. Lustr. Wheel- made
Number of sherds	12	17	24	86	6	2	1	2	25	16	1
Percentage*	6.7%	8.9%	12.5%	43.4%	3.4%	1.2%	0.6%	1.2%	13.0%	8.4%	0.6%

* The percentage is here, as well as in the following tombs, approximated.

This evidence is sufficient for the date, which must be Middle Cypriote III. The single sherd of that rare class, Light-on-Dark Ware is of a certain interest as it connects the tomb with the eastern Cypriote series. The imported ware is represented by the 17 wheel-made sherds.

TOMB 4 (Fig. 119: 12—14; 124: 1)

SIZE

	Length	Width	Depth	Height
Dromos	5.65	1.36	2.35	—
Stomion A	1.09	0.59	—	0.93
Chamber A	4.63	4.67	—	1.71
Stomion B	0.45	0.66	—	0.78
Chamber B	1.69	3.90	—	1.20
Dromos cupboard	0.35	0.50	—	0.51

SHAPE

The dromos is of the long corridor type. Its sides are vertical and two deep steps, ending in a sloping section, lead down to a horizontal area in front of the stomia. The dromos widens gently towards the entrance of Chamber A; below the first step is a round cupboard with sunken floor: it was closed by a circular stone of the local rock.

Two chambers open on to the dromos, one in the prolongation of the longitudinal axis



Fig. 122. Ajos Jakovos. Tomb 1, dromos.

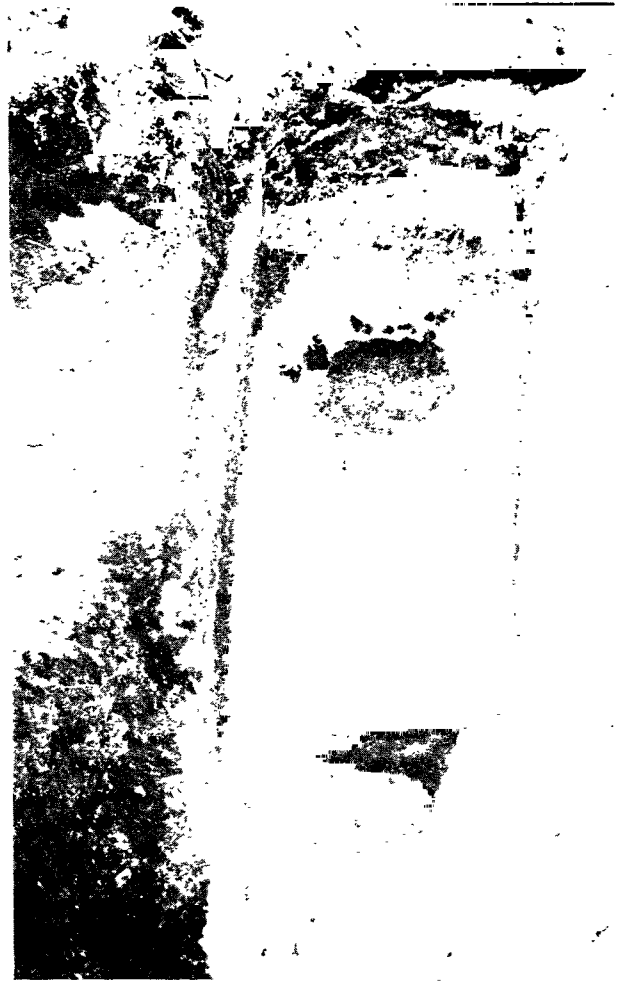

Fig. 123. Ajos Jakovos. Tomb 2, dromos.

of the dromos — Chamber A — and one, Chamber B, from S. E. about 1.15 m. from the front façade of the dromos. The former was closed by a large, square block of heavy, calcareous, black stone. Inside the door stone, starts a long tunnel-shaped stomion, the floor of which lies on a level about 0.15 m. below the bottom of the dromos. The walls of the stomion are strengthened in their upper parts by means of two upright, thin slabs of local limestone, standing on the floor. The chamber, the floor of which lies on the same level as that of the stomion, is roughly circular in shape. In the E. wall is a shallow niche, raised about 0.15 m. above the floor. In the opposite corner is a circular well about 0.95 m. in diameter, and 0.90 m. in depth; it widens slightly towards the base. Roof and walls are fairly well preserved and form a low, arched vault.

Chamber B is irregularly oval in shape, unusually wide in proportion to its length. The floor is horizontal, and roof and walls correspond to those of Chamber A. The stomion is a short, horizontal tunnel, ending in a perpendicular step, about 0.40 m. high. It was blocked up by a thin slab of local limestone, wedged with chips of rock.

STRATIFICATION

The dromos-filling consisted of two layers of horizontally stratified *chavara* and a hard bottom stratum of the same material, but of coarser consistency: on this rested the door slab of Chamber A. The door stone of the chamber was founded directly on the rock floor. A shallow pit was dug through the upper *chavara* layer from the surface of the earth; it was filled with common field earth and must, apparently, be interpreted as traces of a trial digging in modern times. The pit was only driven down about 0.90 m. into the earth, and had done no harm to the tomb.

The fact that the door stone of Chamber A was based on the hard bottom layer shows that there has been two burial periods in the chamber. The bottom stratum covered the base of the door stone of Chamber B, the contents of which, consequently, must be of earlier date than the finds of the second period in Chamber A. The dromos cupboard was carefully closed, but contained only *chavara*, of the same type as the dromos-filling.

In Chamber A the filling consisted of the following layers, from the top: —

- 1) A layer of debris from the roof, spread all over the chamber.
- 2) A fan-shaped layer of dromos earth close to the entrance.
- 3) A thick layer of culture and burial earth mixed in a homogeneous mass, and containing fragments of skeletons and potsherds. It was dry when excavated, but showed distinct traces of having been silted. This layer rested directly on the floor of the chamber, and also covered the stomion where it lay on top of the next stratum.
- 4) A thin layer of the same shape and consistency as Layer 2.
- 5) This layer is a continuation of the bottom layer of the dromos and covered the space immediately inside the threshold.

Layer 3 was not found in the niche. The well was filled by a dark layer of mixed culture earth, containing much bones and burial remains. The lowest section of the layer was wet and silted. Except for the potsherds, the chamber contained only seven pots which were all of small sizes: four of them (Nos. 3—6) were found in the well.

Thus, the general features of the chamber correspond closely to those of Tomb 1, and the stratification must be interpreted in a similar way. After the first burial period, the tomb was thoroughly cleaned and prepared for secondary burials. The finds were taken away, and only some of the smaller ones escaped attention. The niche was entirely cleared and the well filled, and the thick burial layer was levelled equally over the whole chamber. But when all these preparations were finished, no secondary burials were made and the door stone was replaced and the dromos refilled.

The stratigraphical conditions of Chamber B show a similar story. On top of a disturbed burial layer, covering the floor of the chamber, lay two layers of extraneous earth, emanating from the roof and the dromos. The finds were, with one exception (No. 3), lying on the floor. In proportion to the size of the chamber they were very few, and it seems probable that this chamber has gone through a process, similar to that, presumed in Chamber A.

The stratification of the dromos showed, however, that it must have taken place earlier than the clearing of Chamber A; but, to judge from the finds, the difference in time between the two epochs, cannot have been very great.

BURIALS

As the burial strata in the two chambers were disturbed and partly silted, no observations regarding the burial customs could be made.

FINDS (GROUPS: PL. LX, 3, 5; TYPES: L. OF PL. II)

C h a m b e r A

1. Red Polished IV slightly pear-shaped jug with concave neck, and arched handle from rim to shoulder. A line of relief-dots on handle and around shoulder. Height 10.5. Floor.
2. Red Polished IV spherical jug with wide, concave neck, and basket-handle; handle missing. Height 9.5. Floor.
3. White Painted IV shallow bowl with round base, and a loop-handle below rim. Bands of parallel lines crossing the bottom at right angles, both within and without; transverse lines on handle, and a thin line around rim. Diam. 7.7. — 84.
4. White Painted IV bowl, as No. 3, but with horizontal handle. Two broad, crossed lines inside and outside the bottom; groups of wavy lines radiating from the cross, transverse lines on handle. Diam. 8.0. — 84.
5. Red Polished IV, globular bottle with very tall, cylindrical neck; splaying rim, and two string-holes opposite each other below rim. Incised, encircling lines below rim, between neck and shoulder, and below belly; neck decorated with horizontal and oblique hatchings, and body with similar pattern, and a vertical, wavy line. Height 15.0. Floor.
6. Red Polished IV spherical jug with wide, cylindrical neck, and handle from rim to shoulder. Height 8.3. Floor.
7. Red-on-Red depressed, globular jug with narrow, cylindrical neck; wide, splaying rim, and handle from rim to shoulder. A decoration of wavy, purple lines around neck. Height 8.7. Floor.

C h a m b e r B

1. Black Slip II shallow bowl with horizontal handle below rim; paint obliterated. Diam. 7.3. Floor.
2. White Painted IV bowl, as No. 1. Crossed groups of wavy lines outside and inside the bottom, and transverse lines on handle. Diam. 7.9. Floor.
3. White Painted IV bowl, as No. 2, but with loop-handle. Diam. 8.7. — 65.
4. Red-on-Black globular jug with round base; cylindrical neck; splaying mouth, and a low handle from neck to shoulder. A vertical ridge from rim to handle. Bands of horizontal lines around neck and shoulder, and vertical bands from neck to base; transverse lines on handle. Paint worn, rim chipped. Height 19.8. Floor.
5. White Painted IV deep bowl with bent rim; round base, and an upright handle on rim. A black line around rim; inside of handle black. Body decorated with an irregular pattern of groups of black, parallel, wavy lines. Diam. 11.0. Floor.
6. White Painted IV oblong, globular amphora with round base; large, widening neck, and two small, knobbed handles from neck to shoulder. Parallel, wavy lines around neck and belly; vertical bands from rim to base. Height 14.8. Floor.
7. White Painted IV bowl, as No. 2. Thick, straight lines, forming a cross within and without. Diam. 9.0. Floor.
8. White Painted IV bowl, as No. 2. Diam. 8.7. Floor.
9. White Painted IV bowl, as No. 2. Diam. 9.2. Floor.
10. Straight, upwards thickening bronze pin with a small, flattened head, and an eyelet in the middle of the pin. Length 9.4. Floor.

Summing up the Object Register and arranging the finds in different classes, we obtain the following diagram:

	P o t t e r y					B r o n z e	
	R. P. III	Bl. Sl. II	R.-on-Bl.	R.-on-R.	Wh. P. IV	Pin	
Chamber A	1, 2, 5, 6 -4			7 -1	3, 4 -2		
Chamber B		1 -1	4 -1		2, 3, 5, 6 7, 8, 9	10	-1

CHRONOLOGY

As the pots found in the chambers are only a small percentage of the original deposit, they cannot be considered as a safe basis for the dating. To get a complete picture of the contents of the tomb, all the potsherds of dromos and chambers were registered, and their number and proportion can be studied in the following diagram:

		R. P. III-IV	Bl. P.	R. Sl.	Bl. Sl. I-II	R.-on-Bl.	Pl. Wh.	Wh. P. II	Wh. P. III-IV	Wh. P. V	Bl. Sl. I Wh. P. IV	R.-on-Bl. Wh. P. III	Light-on-Dark	Total
Dromos	Number of sherds	26	—	13	59	17	5	—	3	—	—	—	—	123
	Percentage	21.1%	—	10.7%	48.0%	13.8%	4.0%	—	2.4%	—	—	—	—	100%
Chamber A	Number of sherds	283	3	84	312	74	2	2	136	10	4	1	1	912
	Percentage	31.5%	0.4%	9.1%	34.3%	8.5%	0.2%	0.2%	14.0%	1.1%	0.5%	0.1%	0.1%	100%
Chamber B	Number of sherds	2	—	3	18	6	1	—	3	—	—	—	—	33
	Percentage	6.2%	—	9.1%	54.4%	18.2%	3.0%	—	9.1%	—	—	—	—	100%

This distribution gives evidence for dating the tomb to the middle of the Middle Cypriote III period. It is worth noting that the differences in the distribution of the three common wares (Red Polished IV, Black Slip I—II and Red-on-Black) between the two chambers are equalized by the percentage of the respective ware, from the dromos. Thus, Chamber A contains 31.5% Red Polished Ware and Chamber B only 6.2%. The dromos contains roughly the arithmetical mean between the two, i. e., 21.1%; for the Black Slip Ware the numbers are respectively 34.3%, 54.4% and 48.0%; and for the Red-on-Black Ware 8.5%, 18.2% and 13.8%.

The Red Slip Ware is represented by the same percentage in all the cases, and the seemingly great difference between the White Painted Wares III—IV in the two chambers is counterbalanced by the seven pots of that ware in Chamber B. All these circumstances point to the synchrony of the two chambers.

TOMB 5 (Fig. 119: 15, 16)

SIZE

	Length	Width	Depth	Height
Dromos	4.12	1.34	2.47	—
Cupboard	0.80	1.02	—	0.53

SHAPE

The tomb was never completely excavated, as the stratification gave no hope of finding it in an intact state. The dromos is of the long narrow type with two deep steps in the

back end, leading down to the gently sloping area in front of the door. At the back end of the left side of the dromos was a small cupboard, closed by a thin slab of local limestone. Its shape is roughly oval and the floor lay about 0.15 m. below the threshold. The chamber itself had been closed by a thin limestone slab which was found over-turned.

STRATIFICATION

The dromos-filling showed the following stratigraphical sequence:

- 1) A layer of *chavara*, mixed with many small stones and chips of rock. The layer thickened towards the entrance.
- 2) A layer of fine *chavara*, horizontally stratified.
- 3) A similar stratum containing several potsherds, and a few fragments of human remains. This layer ran from the edge of the lower step to the top of the over-turned door stone, and rested directly on the floor.
- 4) From Layer 1 a shaft has been dug in front of the dromos right down to the entrance of the chamber. From this shaft the tomb was entered and sacked, and when excavated, it was filled with mixed earth in oblique stratification.

Layer 3 showed that the tomb has gone through a process similar to that of Tombs 1 and 4, i. e., it has been prepared for a secondary burial, but it could not be stated if this intention was realized or not, as the tomb was robbed in later times. As regards the date of the robbery, it seems reasonable to suppose that it took place at a time when the rock was covered by less earth than at present: a rather remote epoch, probably the Byzantine period.

CHRONOLOGY

The potsherds of Layer 3 date the time when the tomb was cut and the first time used for burial purpose. They consisted of the following wares:

	R. P. III-IV	Bl. P.	Bl. Sl. I-II	R.-on-Bl.	Wh. P. III-IV	Total
Number of sherds	102	7	57	10	15	191
Percentage	53.4 %	3.5 %	29.8 %	5.5 %	7.8 %	100 %

This survey shows that it must be dated to a rather early part of the Middle Cypriote III period. The great percentage of Red Polished Wares, a great amount of which were incised, is a special feature of this tomb.

TOMB 6 (Figs. 124: 2; 125: 1—4; 131)

SIZE

	Length	Width	Depth	Height
Dromos	3.88	1.20	1.81	—
Stomion	0.60	0.70	—	0.57
Chamber	3.75	4.90	—	1.02

SHAPE

The dromos is of the narrow corridor type, but slightly shorter and wider than usual. The sides are perpendicular and a long, oblique step leads down from the edge of the rock to the sloping area in front of the stomion. A single massive slab of heavy, black stone covered the entrance. It was standing on one corner in a slightly oblique position, and, therefore, did not fit into the square moulding, cut in the façade to keep it in position. The stomion is a narrow tunnel which slopes gently down to the level of the chamber floor. The chamber is roughly circular, or rather "kidney-shaped". Its floor is uneven and the roof is a flat, slightly arched vault.

STRATIFICATION

Below the layer of surface earth, 0.80 m. thick, the dromos-filling started. It was simply stratified and consisted of three roughly horizontal layers of broken *chavara*. The top layer projected slightly above the edge of the rock, and the bottom layer was of a darker colour than the others. In the chamber comparatively little extraneous earth was found. Some debris from the roof had fallen, especially in the eastern part of the chamber. A layer of dromos earth was spread close to the entrance, and below this was the find stratum: this consisted of burial layers all around the walls and in the centre of the chamber, covered by a dry layer of brown, silted clay. In this stratum some finds and skeletal remains were found slightly raised above the rock floor, a circumstance which is of no conclusive value as regards the relative chronology of burials and finds. Any essential significance cannot even be attributed to the slightly higher position of finds Nos. 3, 4, 10, 11, 13, 14, 17, and 90.

The only key to the chronological sequence between the finds, is the position of the bodies to which they can be assigned. Eleven skeletons, numbered from left to right I—XI, were found near the walls of the chamber, and four in the central area: XII—XV. All the bodies were surrounded by their personal tomb-gifts which had, apparently, been left *in situ* by the people who carried out the later burials. There seems only to be one exception from this rule, viz. a piled-up deposit of vases (Nos. 3—12), just to the left of the entrance. No other evidence for the attribution of these finds is offered except the finds themselves and their fabrics. Therefore, they are, in the following classification, treated under a special heading. It is clear from practical reasons, that the four burials XII—XV are later than the rest, as they obstruct the way for the latter (cf. Tomb 313 A in Lapithos, p. 87). The finds which can be attributed to these four burials must, consequently, be assigned to a later epoch. The plan (Fig. 124: 2) shows that the finds in question are Nos. 28—38, 51—66, 76—79, 109—119, 158—160, and 163.

BURIALS

The skeletal material was in a fairly good state of preservation and was mainly *in situ*. It must, however, be born in mind that the silted, clayey layer, which covered the burial strata, cannot have been without influence on the positions of the bones.



Fig. 124. Ajos Jakovos. Tomb 4, Plan (1). Tomb 6, Finds *in situ* (2).

The burial remains around the walls of the chamber were limited to a stratum about 0.70 m. broad, in which the bones of the eleven skeletons were found. The circumference of this area is only about 9.50 m., and, thus, the space for each body and its tomb-gifts was limited, on an average, to approx. 0.70 : 0.90 m. This circumstance makes any position, except contraction, impossible. To start with one of the most complete skeletons — No. VII — it shows some very typical traces. The knees were drawn up at a sharp angle and partly covered the tibiae. Above some fragments of the pelvis, lay the remains of the ribs; the spinal column was preserved in two pieces; one very curved, and one consisting of two vertebrae on top of one another; the skull was found close to the wall. All these features are evidence of a sitting position with contracted legs, and the back against the wall. The body had been adorned with a necklace of faience beads, which were spread all over the skeleton. Skeletons Nos. VIII and IX can, for the same reasons be reconstructed in a similar way, but here the bones were in a more fragmentary state. Skeletons Nos. XIII and XIV show the same main characteristics. In No. X the distribution of the beads indicate a similar position, as is also the case with regard to Nos. III and IV. The rest of the bodies are very difficult to analyse, but so much can be stated that there is nothing that denies a similar position for all the other bodies, and by analogy, it is reasonable to reconstruct these burials in accordance with the known cases. Thus, the skeletons have been sitting in crouching positions around the walls of the chamber, each surrounded by their personal tomb-gifts and many of them adorned with necklaces of faience beads. The later group of bodies were placed in similar positions in the centre of the chamber.

Tomb 6 is especially valuable from the point of view of the picture it gives of the general appearance of tombs like T. 1 and T. 4 before they were entirely cleared for the secondary burials, assumed above (cf. pp. 302 and 309).

FINDS (GROUPS: PLS. LXI, LXII, I; TYPES: L. OF PL. II)

1. White Painted II pear-shaped jug with two necks; beaked mouths, and an anthropomorphic handle from rim to shoulder. Vertical, wavy lines, encircling lines, network and chess-board friezes on mouths and necks; broad lattice bands from neck to base. On one side are two parallel, wavy lines between the vertical bands; three conventionalized designs of goats on the opposite side. Crossed lines on handle. Height 24.2. Floor.
2. Black Slip II globular jug with knobbed base; concave neck, and handle from neck to shoulder. Mottled surface. Height 45.0. Found on top of Nos. 3 and 5.
3. Black Slip II oval amphora with knobbed, round base; concave neck, and two handles from neck to shoulder. Mottled surface. Height 26.1. — 49.
4. Black Slip II oval hydria with wide, concave neck; a vertical handle from neck to shoulder, and a horizontal handle on shoulder. Dotted lines on edge of handles, and from neck to shoulder. A wide, flat knob as base-ring. Mottled surface. Height 33.3. — 49.
5. Black Slip II amphora, as No. 3. Mottled surface. Height 26.2. Floor.
6. Black Slip I hemispherical bowl with a horn-shaped string-hole knob at rim. Somewhat mottled surface. Diam. 16.0. Floor.
7. Red Polished III pear-shaped jug with round base; tall, tapering neck; wide funnel-rim, and handle from rim to shoulder. Bands of encircling lines around neck, shoulder and belly, and a large zigzag band with dotted, horizontal lines around belly. Height 11.4. Floor.
8. Red-on-Black almost hemispherical bowl with a horizontal handle below rim. Red, wavy lines crossing the bottom at right angles, both within and without. Handle missing. Diam. 9.6. Floor.
9. Black Slip II hydria, as No. 4. Height 38.2. Found on top of No. 10.
10. Black Slip III shallow bowl with round base; in-turned rim, and a string-hole projection at rim. Mottled surface. Diam. 10.2. — 51.
11. Black Slip II pear-shaped jug with round base; narrow neck; splaying rim, and handle from neck to shoulder. Mottled surface. Height 23.4. — 51.

12. Black Slip II jug, as No. 2. Mottled surface. Height 47.5. Found on top of No. 13.
13. Black Slip II jug, as No. 11. Not complete. Mottled surface. Height 18.6. — 56.
14. Red Slip shallow bowl with round base, and a horn-shaped string-hole projection at rim. Diam. 17.9. — 56.
15. Bobbin-shaped whetstone with round top pierced by a hole. Length 7.4. Found inside No. 14.
16. Black Slip II oval amphora with knobbed base; widening neck, and two handles from neck to shoulder. Mottled surface. Height 29.2. Found on top of No. 17.
17. Red Polished III squat, pear-shaped jug with wide, concave neck; three short legs; handle from rim to shoulder, and a small projection opposite the handle. Encircling lines around neck, shoulder and base, and a frieze of parallel zigzag lines around belly. Height 9.6. — 56.
18. Black Slip II oval jug with tall, narrow neck; a groove from rim to handle; oblique mouth, and handle from neck to shoulder. Height 22.1. Floor.
19. Red Polished IV deep bowl of irregular shape, with round base, and a pointed string-hole projection at rim. Partly blackened. Diam. 12.2. Floor.
20. Red Polished IV globular bottle with round base; tall, cylindrical neck; splaying rim, and two string-holes below rim. Chess-board patterns and vertical zigzag lines on neck; a frieze of plain lozenges with hatched borders alternating with lozenges, filled with zigzag lines around body; encircling lines around neck and belly. Rim and part of body chipped. Height 17.3. Floor.
21. Red Polished IV shallow bowl with round base, and a small string-hole projection below rim. Diam. 10.5. Floor.
22. Plain White Hand-made almost hemispherical bowl with an upright, horn-shaped string-hole projection at rim. Diam. 9.6. Floor.
23. Black Slip II squat, pear-shaped jug with cylindrical, short neck, and knobbed handle from rim to shoulder. Height 8.4. Floor.
24. Red Polished III hemispherical bowl with a large string-hole projection at rim. Diam. 18.0. Floor.
25. Red Polished IV hemispherical bowl with round base, and a high, knobbed, vertical handle on rim. Diam. 11.4. Floor.
26. White Painted IV shallow bowl with round base, and a horizontal handle below rim. Wavy lines from edge to edge, crossing the bottom at right angles both within and without; transverse lines on handle. Dark surface. Diam. 11.2. Floor.
27. Red-on-Black globular jug with concave neck, and handle from rim to shoulder. Groups of wavy lines from neck to base. Handle missing. Height 9.7. Floor.
28. Red-on-Black flat bowl with round base, and an incised circle marking the base-ring; a small, pointed string-hole projection, and an open spout opposite the projection. Decorated as No. 26. Mottled surface. Diam. 11.7. Floor.
29. Red Polished III hemispherical bowl with a pointed string-hole projection at rim. Diam. 13.0. Floor.
30. Black Slip II ovoid jug with slightly pointed base; concave neck; beaked mouth, and a handle from rim to shoulder. 19.2. Floor.
31. Red Polished IV ovoid amphora with pointed base; wide, cylindrical neck; splaying rim, and two handles from neck to shoulder. Paint much worn; rim and neck partly missing. Height 28.5. Floor.
32. Black Slip II flat bowl with round base, and a string-hole projection at rim. Mottled surface. Diam. 17.2. Floor.
33. Red Polished III jug, as No. 7. Body covered with short, horizontal lines, forming a chess-board pattern. Height 13.4. Floor.
34. Black Slip II small, pear-shaped jug with cylindrical neck, and raised handle from rim to shoulder. Mottled surface. Height 9.2. Floor.
35. Black Slip II shallow bowl with high, vertical handle. Diam. 12.9. Floor.
36. Red Polished III shallow bowl with vertical handle from rim to body, and an open spout opposite the handle. Diam. 12.3. Floor.
37. Shallow bowl of Composite Ware (Red-on-Black and White Painted IV) with round base, and a horizontal handle below rim. Wavy lines crossing the bottom at right angles, both within and without. Red-on-Black inside and White Painted outside. Diam. 9.3. Floor.
38. Straight, upwards-thickening bronze-pin with a small, flattened head, and an eyelet at middle of pin. Length 7.6. Floor.
39. Black Slip II pear-shaped bottle with narrow, cylindrical neck, and two string-holes below rim; paint almost obliterated. Height 11.5. Floor.
40. Red Slip small, shallow bowl with round base, and a long horn-shaped string-hole projection. Diam. 8.0. Floor.
41. Black Slip I bowl, as No. 29. Mottled surface. Diam. 11.3. Floor.
42. Red-on-Black shallow bowl with round base, and a horizontal handle at rim. Decorated as No. 26. Diam. 13.7. Floor.
43. Black Slip II bowl, as No. 14. Diam. 7.5. Floor.
44. Red Polished III jug, as No. 7. Hatched bands from neck to base. Handle missing; rim chipped. Height 9.7. Floor.
45. Red Polished III globular bottle with round base; narrow neck; beaked mouth; two small handles from neck to shoulder. Height 7.4. Floor.
46. Red Polished III jug, as No. 7. Height 9.3. Floor.
47. Red Slip bowl, as No. 40. Diam. 7.0. Floor.
48. Red Polished III slightly pear-shaped jug with cylindrical neck; splaying rim, and an upright, horizontal handle on rim. Decorated as No. 7. Height 12.6. Floor.
49. Red Polished III hemispherical bowl with a string-hole projection at rim. Hatched bands, and encircling and crossed lines on body. Diam. 8.8. Floor.
50. Plain bronze pin. Length 15.0. Floor.
51. White Painted IV wide, shallow bowl with round base;

- a string-hole projection at rim, and an open spout opposite the projection. Encircling lines around rim; broad lines radiating from centre to rim, and groups of wavy lines in their interstices. Diam. 17.6. Floor.
52. Black Slip II bowl, as No. 22. Diam. 8.8. Floor.
53. Black Slip II shallow bowl with round base, and an ear-shaped string-hole projection at rim. Diam. 8.6. Floor.
54. Red Slip bowl, as No. 40. Diam. 7.7. Floor.
55. Red Polished IV shallow bowl with round base, and a string-hole projection at rim. Paint worn. Diam. 7.7. Floor.
56. Shallow bowl of Composite Ware (Black Slip II and White Painted IV) with round base, and a horn-shaped projection below rim. Black Slip outside; interior decoration, as No. 51. Diam. 11.8. Floor.
57. Red-on-Black jug, as No. 27, but with raised handle from neck to shoulder, and wavy lines around rim. Height 6.7. Floor.
58. Shallow bowl of Composite Ware (Black Slip II and White Painted IV), as No. 56. Projection missing. Diam. 17.3. Floor.
59. Red Slip shallow bowl with round base, and a horizontal handle below rim. Diam. 16.1. Floor.
60. Black Slip II bowl, as No. 22. Diam. 11.1. Floor.
61. Red-on-Black almost hemispherical bowl with a double-horned, square handle below rim. Decorated as No. 8. Diam. 9.6. Floor.
62. Red Slip shallow bowl with round base. Handle missing. Diam. 7.7. Floor.
63. Red Slip bowl, as No. 59. Half the bowl missing. Diam. 8.0. Floor.
64. Black Slip II oval jug with round base; cylindrical neck, and raised handle from rim to shoulder. Handle missing. Mottled surface. Height 19.0. Floor.
65. Red Slip bowl, as No. 22, but without string-hole. Diam. 11.2. Floor.
66. Red Slip bowl, as No. 40. Diam. 7.7. Floor.
67. Black Slip II globular amphora with short, wide neck, and two knobbed, incised handles from rim to shoulder. Two knobs on shoulder. Height 14.7. Floor.
68. Red Polished IV oval jug with pointed base; cylindrical neck; beaked mouth, and handle from rim to shoulder. Paint worn; rim partly missing. Height 11.8. Floor.
69. Black Slip II globular jug with cylindrical neck, and raised handle from rim to shoulder. Height 8.3. Floor.
70. Black Slip II miniature jug, as No. 11. Paint partly worn. Height 5.9. Floor.
71. Red-on-Red shallow bowl with round base; in-bent rim, and a loop-handle below rim. Transverse lines on handle. Edge partly missing. Diam. 8.3. Floor.
72. Fragments of a Red Slip jug, probably as No. 34. Diam. 5.7. Floor.
73. Black Slip II jug, as No. 18. Damaged. Height 18.8. Floor.
74. Red-on-Black shallow bowl with round base, and a string-hole at rim. The bowl is an imitation of a metal prototype. Diam. 16.7. Floor.
75. Red-on-Red bowl, as No. 71. Diam. 8.7. Floor.
76. Black Slip II jug, as No. 34, but with low handle. Height 10.2. Floor.
77. Bronze pin with a small, flattened head, and an eyelet at middle of pin. Length 12.6. Floor.
78. Black Slip II jug, as No. 18; paint slightly worn. Height 19.0. Floor.
79. Red Slip jug, as No. 18, but with knobbed base. Paint worn; upper part of neck missing. Height 20.4. Floor.
80. Red-on-Black bowl, as No. 22. Decorated as No. 8. Diam. 11.5. Floor.
81. Leaf-shaped bronze knife with two cutting edges; mid-rib; concave sides; curved top, and short, flat tang with three rivets. Length 14.3. Floor.
82. Black Slip II bowl, as No. 21. Diam. 9.0. Floor.
83. Black Slip II bowl, as No. 53. Knob missing. Diam. 11.6. Floor.
84. White Painted V bowl, as No. 62, but with ladder-pattern instead of wavy lines. Diam. 10.3. Floor.
85. Red Slip jug, as No. 34, but with shorter neck. Handle missing. Height 9.6. Floor.
86. Black Slip I bowl, as No. 6. Diam. 10.3. Found inside No. 87.
87. Red Polished III hemispherical bowl with an anthropomorphic string-hole projection at rim. Rim and inside blackened. Diam. 14.0. Found on top of No. 88.
88. Red Polished III bowl, as No. 36, but with raised handle; spout chipped. Diam. 11.1. Floor.
89. Red Polished III bowl, as No. 88, but deeper. Spout chipped. Diam. 18.5. Floor.
90. Black Slip II jug, as No. 85. Handle missing. Height 10.3. — 34.
91. Plain bronze pin without head. Length 16.1. Floor.
92. Red-on-Black bowl, as No. 22. Decorated as No. 8. Diam. 13.5. Floor.
93. Black Slip I bowl, as No. 6. Diam. 15.7. Floor.
94. Black Slip II globular jug with wide, slightly conical neck; oblique mouth, and handle from neck to shoulder. Mottled surface. Height 18.5. Floor.
95. Red-on-Black jug, as No. 69. Height 9.2. Floor.
96. Red Polished III bowl, as No. 88. Handle missing; black inside. Diam. 8.7. Floor.
97. Black Slip I bowl, as No. 6. Diam. 8.2. Floor.
98. Red Slip bowl, as No. 59. Handle missing. Diam. 9.2. Floor.
99. Thick bronze pin with button-head. Length 8.7. Floor.
100. Red Polished III globular jug with round base; narrow, cylindrical neck, and two small handles from neck to shoulder. Height 10.2. Floor.
101. Black Slip I bowl, as No. 6. Diam. 13.2. Floor.
102. Red Polished III bowl, as No. 24. Diam. 9.8. Found on top of No. 103.
103. Red Polished III bowl, as No. 24. Diam. 9.2. Floor.
104. Thin, circular shield-boss of bronze with two holes at the edge, and adorned with enchased, circular ridges around a central button. More than the half missing. Diam. about 8.7. Floor.

105. Red Polished III bowl, as No. 24. Diam. 18.4. Floor.
106. Red-on-Black bowl, as No. 42, but with loop-handle and in-bent rim. Diam. 9.6. Floor.
107. Red-on-Black bowl, as No. 71. Decorated as No. 26. Diam. 11.0. Floor.
108. Shield-boss, as No. 104, but better preserved. Diam. 7.1. Floor.
109. Black Slip II shallow bowl with in-bent rim, and a horn-shaped projection at rim. Diam. 11.0. Floor.
110. Black Slip I shallow bowl with round base; horn-shaped string-hole projection, and an open spout opposite the projection. Mottled surface. Diam. 19.5. Found on top of No. 111.
111. Red Slip jug, as No. 85. Height 10.4. Floor.
112. Red-on-Red globular jug, as No. 18. Wavy lines from neck to base. Height 24.8. Floor.
113. Red-on-Red bowl, as No. 22. Decorated as No. 8. Diam. 10.5. Floor.
114. Black Slip II jug, as No. 2. Mottled surface. Height 44.9. Floor.
115. Red Polished IV bowl, as No. 14. Diam. 15.3. Floor.
116. Red-on-Black globular jug with round base. Groups of wavy lines around shoulder, and circles in their interstices. Neck and handle missing. Height 12.5. Floor.
117. Shallow bowl of Composite Ware (White Painted IV and Red-on-Black), as No. 37, but with loop-handle. Diam. 9.2. Floor.
118. Red Polished III bowl, as No. 24. Diam. 11.3. Floor.
119. Black Slip II bowl, as No. 53, but with in-bent rim. Diam. 9.7. Floor.
120. Red Polished IV bowl, as No. 59; handle broken. Diam. 8.7. Floor.
121. Black Slip II bowl, as No. 35; handle missing. Mottled surface. Diam. 7.4. Floor.
122. Two plain bronze pins. Length 11.0; 9.6. Floor.
123. Black Slip II bowl, as No. 40. Diam. 8.9. Floor.
124. White Painted IV bowl, as No. 26, but with loop-handle. Diam. 9.5. Floor.
125. Black Slip II oval jug with round base. Neck and handle missing. Mottled surface. Height 5.5. Found inside No. 126.
126. Black Slip II bowl, as No. 59. Diam. 9.2. Floor.
127. White Painted IV bowl, as No. 26. Handle broken. Diam. 9.8. Floor.
128. Thin bronze pin with coiled head. Length 6.7. Floor.
129. Black Slip II bowl, as No. 22. Diam. 16.0. Floor.
130. Black Slip II jug, as No. 18. Height 13.4. Floor.
131. Red Slip bowl, as No. 71. Handle broken. Diam. 8.6. Floor.
132. Black Slip II jug, as No. 18. Mottled surface. Height 14.0. Floor.
133. Black Slip II globular jug with round base, concave neck, and handle from neck to shoulder. Rim and handle damaged. Height 24.8. Found on top of No. 134.
134. Black Polished hemispherical bowl with a string-hole projection at rim. A frieze of hatched lozenges around rim; parallel zigzag lines around body, and an encircled star in the bottom. Damaged. Diam. 10.5. Floor.
135. Red Polished III slightly pear-shaped jug with round base; tall, cylindrical neck; an angular handle from neck to shoulder, and a large string-hole projection opposite the handle. Encircling lines around neck, shoulder, and below belly; concentric semicircles on shoulder, and a frieze of hatched lozenges around belly; hatchings on handle. Rim missing. Height 29.7. Floor.
136. Black Slip II hemispherical bowl with a small, profiled string-hole projection at rim. Diam. 7.5. Found on top of No. 137.
137. Red Slip bowl, as No. 14. Diam. 18.2. Floor.
138. Red Polished III bowl, as No. 24; projection missing. Diam. 12.0. Floor.
139. Scraper of bronze with straight end; concave sides; narrow, curved top, and flat tang with a rivet-hole. Length 11.1. Floor.
140. Plain bronze pin. Length 9.2. Floor.
141. Bronze pin with thickening top. Length 18.1. Floor.
142. Leaf-shaped bronze knife with two edges; midrib; broad, angular top; long, tapering tang with two rivet-holes. Length 10.0. Floor.
143. Broad bronze scraper with concave sides, and two rivets through top. Length 7.7. Floor.
144. Thin bronze chisel with short, narrow, cylindrical tang. Length 8.2. Floor.
145. Leaf-shaped bronze knife with two edges; straight sides; midrib; tapering top, and wide, short tang with three rivet-holes. Length 10.9. Floor.
146. Bronze tweezer with loop-shaped top. Length 10.0. Floor.
147. Red Polished III jug, as No. 7. Encircling lines around shoulder, belly, and base; zigzag bands between the encircling lines. Neck and handle missing. Height 10.8. Floor.
148. Red Polished IV bowl, as No. 21. Diam. 9.4. Floor.
149. Red Polished IV deep miniature bowl with a roughly anthropomorphic string-hole projection on rim. Diam. 7.5. Floor.
150. Red Polished III bowl, as No. 36, but with a square, upright handle on rim; spout chipped. Diam. 14.6. Floor.
151. Fragments of bronze spirals, probably belonging to a head-dress. Floor.
152. Plain bronze pin with thickening top. Length 13.4. Floor.
153. Bronze pin, as No. 152, but with a bronze wire wound round the middle. Point missing. Length 11.6. Floor.
154. Several necklaces of in all 220 globular beads of porcelain-paste, one of which cylindrical. On some of the beads a faint blue colour is still preserved. Floor.
155. A set of miniature cylindrical beads, belonging to the necklaces No. 154. Floor.
156. Beads of porcelain-paste, as No. 154, and belonging to the same necklaces. Floor.
157. Black Slip II jug, as No. 34. Height 9.3. Floor.

- 158. Black Slip II bowl, as No. 55. Mottled surface. Diam. 12.0. Floor.
- 159. White Painted V bowl, as No. 26. Diam. 10.0. Floor.
- 160. Narrow bronze knife with two edges; straight sides, and flat tang with one rivet-hole. Length 11.5. Floor.
- 161. Fragment of a shield-boss of bronze, as No. 104. Floor.
- 162. Small necklace of ten globular beads of faience. Floor.
- 163. Small necklace of eight globular beads of faience. Floor.
- 164. Triangular bronze knife with two edges; straight sides and triangular top with three rivets. Point is purposely bent. Length 4.9. Floor.
- 165. Circular finger-ring of bronze. Broken. Diam. c. 2.4. Floor.

Summing up the Object Register, and dividing the finds among their different classes, we obtain the following diagram:

		Pottery											Bronze						Faience Stone									
		R. P. III	R. P. IV	Bl. P.	Bl. Sl. I	Bl. Sl. II	Bl. Sl. III	R. Sl.	Wh. P. II	Wh. P. IV	Wh. P. V	R.-on-Bl.	R.-on-R.	Pl. Wh.	R.-on-Bl. + Wh. P. IV	Bl. Sl. II + Wh. P. IV	Shield-bosses	Knives	Scrapers	Chisel	Tweezer	Pins	Spiral	Ring	Beads	Necklaces	Whetstone	
1st group	17.	24	19	134	18.	2.	13	14	1	26	84	27	71	22			104	81	139	144	146	50	151	165	155	154	15	
	44.	45	20		41	16.	18	40		124		42	75				108	142	143			91			156	162		
	46.	48	21		86	23.	39	47		127		74					161	145				99			163			
	49.	87	25		93	43.	67	72				80						164				122						
	88.	89	68		97	69.	70	85				92										122						
	96.	100	120		101	73.	82	98				95										128						
	102.	103	148			83.	90	131				106										140						
	105.	135	149			94.	121	137				107										141						
	138.	147				123.	125															152						
	150					126.	129															153						
						130.	132																					
						133.	136																					
						157																						
		-19	-8	-1	-6	-25			-8	-1	-3	-1	-8	-2	-1			-3	-4	-2	-1	-1	-10	-1	-1	-2	-3	-1
	2nd group	29.	33	31		110	30.	32	54	51	159	28	112			37	56	160					38					
36			55			34.	35	59			57	113			117	58						77						
			115			52.	53	62			61																	
			118			60.	64	63			116																	
						76.	78	65																				
						109.	114	66																				
						119.	158	79																				
								111																				
	-3	-4		-1	-14			-8	-1	-1	-4	-2		-2	-2		-1					-2						
Common group	7			6	3.	4	10				8																	
	-1			-1	5.	9																						
					11.	12																						
					-6	-1																						

CHRONOLOGY

Considering the differences in the distribution of the classes of vases between the two groups, there are some features worth mentioning: thus the proportion between the Red Polished Wares III and IV in the older group is 2: 1, but in the later 3: 4, a considerable displacement which demonstrates the difference in time. Also the Red Slip ware increases in the later group from 9.5 % to 20.3 % and the Black Slip I Ware up to 75 %, is to be

found in the first group. Further the four specimens of mixed wares Nos. 37, 117, 56 and 58 all belong to the later group. The Black Slip II and the Red-on-Black Wares keep their proportions approximately in both groups. As regards the common group (cf. above p. 315) it is difficult to decide to which group they originally belonged, except for the Black Slip III bowl, No. 10, which must surely be assigned to the later period.

Both groups fall within the Middle Cypriote III period, the later towards the middle of the epoch.

TOMB 7 (Fig. 125: 5—9)

	SIZE			
	Length	Width	Depth	Height
Dromos	2.43	1.29	1.71	—
Stomion	0.45	0.69	—	0.64
Chamber	2.16	3.90	—	c. 1.35

SHAPE

The dromos is oblong with perpendicular sides, and two steps, starting from the semicircular end, lead down to a square, horizontal area in front of the stomion. The doorway was closed by a thin stone slab in a vertical position; the stomion runs horizontally, contrary to the usual system, and there is no difference in level between stomion and chamber. The chamber is “kidney-shaped” and provided with two shallow, circular pits and one niche raised about 0.65 m. above the level of the floor. The edge of the niche is raised so that it forms a low partition. One pit is cut near the back wall, approximately opposite the entrance about 0.20 m. deep, another below the niche to the left of the entrance; its depth is 0.30 m. The uniform level of dromos, stomion and chamber caused the special shape of the roof; and it can be reconstructed as an irregular barrel-vault reaching its apex in the transverse axis of the chamber. The section above the niche is slightly higher than the opposite side.

STRATIFICATION

The dromos-filling consisted of *chavara*, and gave the impression of being intact, but because of an inadvertency during excavation, it was never observed in detail. In the chamber the following layers were found: —

- 1) A high ridge of debris fallen from the roof lay along the transverse axis of the chamber. Its greatest thickness was approx. 1.00 m., but as it had fallen gradually and was finely pulverized, it had caused no great damage to the deposits below.
- 2) A dry layer of brown clay which had apparently been silted. Some of the pots were found raised up in this stratum.
- 3) Burial layers with skeletal remains were found near the back wall, in the left half of the chamber, and in the niche. The burial below the niche rested on a thin layer of sand.

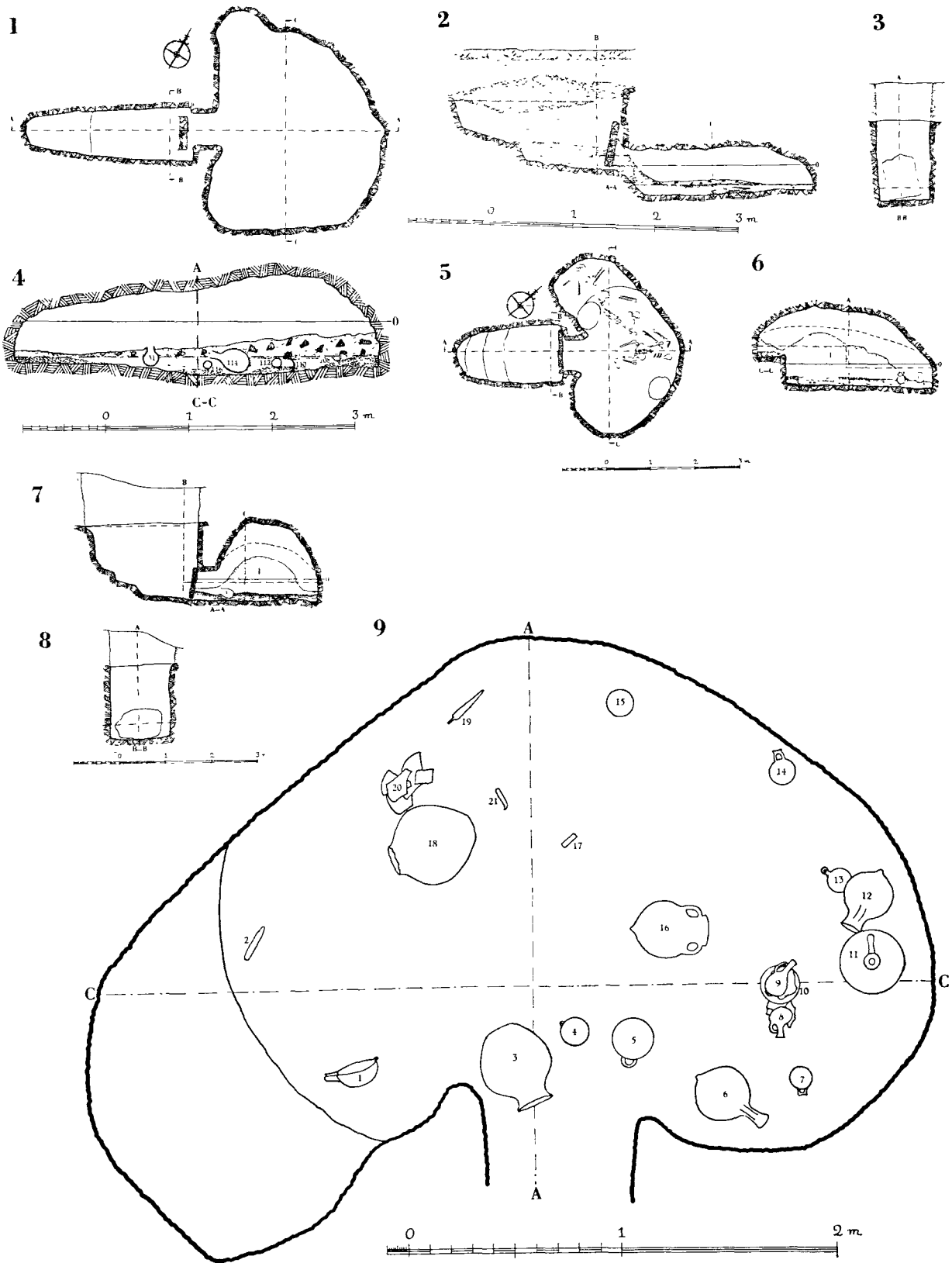

Fig. 125. Ajos Jakovos. Tomb 6, Plan (1); Sections A-A, B-B, C-C (2, 3, 4). Tomb 7, Plan (5); Sections C-C, A-A, B-B (6, 7, 8); Finds *in situ* (9).

To the different levels of the vases on the floor no significance can be attributed because of the silted state of Layer 2. Therefore, all the tomb-gifts must be considered as a single group.

BURIALS

Remains of four skeletons were found in the chamber, one in the niche and three on the floor. The one in the niche had been deposited in lateral position with slightly contracted legs, and sharply bent arms. Below the niche lay scattered remains of another body, the original position of which it was difficult to state. It has, evidently, been partially removed when the last body was brought into the chamber. The latter was found in outstretched, dorsal position along the longitudinal axis of the chamber, in a fairly good state of preservation. Finally a femur and some other small fragments of bones must be ascribed to a fourth skeleton, which had almost entirely vanished.

FINDS (GROUPS: PL. LX, 4, 6; TYPES: L. OF PL. II)

1. White Painted IV wide, shallow bowl with round base; horizontal handle, and an open spout opposite the handle; four string-holes, flanked by two horn-shaped projections on spout. A rich pattern of radiating and crossed, wavy lines inside the bowl, and a more regular pattern of the same elements outside. Spout, projections, and handle are covered with wavy and straight transverse lines. Piece of handle missing. Diam. 18.6. Floor.
2. Leaf-shaped, double-edged bronze knife with midrib; straight sides; broad, flat tang with three rivet-holes. Pointed end; purposely bent. Length 18.1. Floor.
3. Plain White Hand-made wide, oval jar with flat base; short, concave neck, and widening rim. Short, vertical punctured bands in relief on shoulder. Outside of bottom and lower part of jar are covered with a layer of plaster. Height 37.5. Floor.
4. Red Polished IV shallow bowl with round base; slightly in-turned rim, and a string-hole projection at rim. Diam. 13.6. Floor.
5. Red Slip wide bowl with flattened base, and an up-turned, horizontal handle near the rim. Diam. 19.2. Floor.
6. Red-on-Black globular jug with base-knob; concave neck; splaying rim, and handle from neck to shoulder. Wavy lines around rim and neck; a horizontal group of wavy lines around belly, and groups of hanging wavy lines from neck to base; transverse lines on handle. Paint partly worn; the vase has been repaired in ancient times. Height 38.4. Floor.
7. White Painted IV shallow bowl with round base, and a double-horned, horizontal handle near the rim. Groups of parallel lines crossing the bottom at right angles, both within and without. Pink ground; reddish paint. Diam. 10.6. Floor.
8. Red-on-Black globular jug with round base; tall, widening neck, and handle from root of neck to shoulder. Decorated as No. 6. Paint worn; rim chipped; pieces of body missing. Height 15.1. Found on top of No. 10.
9. Black Slip II pear-shaped jug with a rudimental base-ring; concave, short neck; beaked mouth, and a knobbed handle from rim to shoulder. Knobs and deeply incised, short, horizontal lines on shoulder; a similar decoration on neck opposite the handle. Part of base missing. Height. Found on top of No. 10.
10. Red-on-Black jug, mainly as No. 6. Paint worn; rim chipped; pieces of body missing. — 44.
11. Red-on-Black jug, as No. 6, but without horizontal lines around belly. Paint worn. Height 40.0. — 44.
12. Black Slip II oval amphora with base-knob; concave neck, and two handles from neck to shoulder. Mottled surface. Height 32.4. — 43.
13. Bowl of Composite Ware (Red Slip and White Painted IV), as No. 7, but with loop-handle. The bowl is Red Slip outside and White Painted inside, of the same pattern as No. 7. Damaged. Diam. 11.8. Floor.
14. White Painted IV bowl, as No. 7. Stripes and ladder-patterns arranged as No. 7. Diam. 12.5. Floor.
15. Red Polished IV very flat bowl with round base. Diam. 13.0. Floor.
16. Black Slip II amphora, as No. 12. Height 38.0. Floor.
17. Flat whetstone with round, horizontally pierced top. Length 7.4. Floor.
18. Plain White Hand-made jar, as No. 3. Neck and rim missing. Height 39.2. Floor.
19. Leaf-shaped double-edged bronze dagger with midrib; straight sides; sloping shoulders, and hooked, solid tang. Length 22.1. Floor.
20. Red Polished III wide, shallow bowl with round base; a vertical handle from rim to body, and an open spout opposite the handle. Diam. — 41.
21. Leaf-shaped bronze knife with concave sides; midrib, and rounded top with four rivet-holes. Length 12.0. Floor.

Summing up the Object Register, we obtain the following diagram:

P o t t e r y								Bronze		Stone
R. P. III	R. P. IV	R. Sl.	Bl. Sl. II	Pl. Wh.	R.-on-Bl.	Wh. P. IV	R. Sl. + Wh. P. IV	Dagger	Knives	Whetstone
20	4. 15	5	9. 12, 16	3. 18	6. 8, 10. 11	1. 7. 14	13	19	2. 21	17
-1	-2	-1	-3	-2	-4	-3	-1	-1	-2	-1

CHRONOLOGY

The diagram shows that the contents of the chamber are fairly consistent from a chronological point of view. The date of the tomb is the latter half of the Middle Cypriote III period.

TOMB 8 (Figs. 126: 1—4; 127; 128)

SIZE

	Length	Width	Depth	Height
Dromos	3.37	1.10	2.21	—
Stomion	0.27	0.59	—	1.01
Chamber	3.56	5.75	—	c. 1.60

SHAPE

The dromos is a narrow passage which widens gradually towards the entrance. The sides are vertical, and three distinct steps lead down from the edge of the natural rock to a roughly horizontal, rectangular area in front of the stomion. The door-packing consisted of two thin, irregular slabs, strengthened by a thicker one, and kept in position by some small chips of the local rock.

The shape of the chamber is exceptional. From the stomion leads a perpendicular step, about 0.50 m. high, down to the floor of the circular central area. Three roughly circular niches are symmetrically arranged around this central pit. They are raised about 0.70—0.80 above the floor. Each niche has about the same floor space as the central area, and the plan of the whole chamber resembles a regular trefoil. The edges of the niches are somewhat raised and form low partitions. The floors are horizontal and the roof forms a flat vault.

STRATIFICATION

The rich and intact stratification of this tomb makes it especially valuable from a chronological point of view.

The dromos was filled with two layers of horizontally stratified *chavara* and a bottom layer of the same material, but of coarser consistency. The bottom layer covered the lowest step of the dromos and ran horizontally from the step to the stomion, where it sank abruptly to the threshold: on top of this layer was founded the door-packing. Through the two upper layers of *chavara* a narrow pit was dug, leading down to the door and filled with mixed

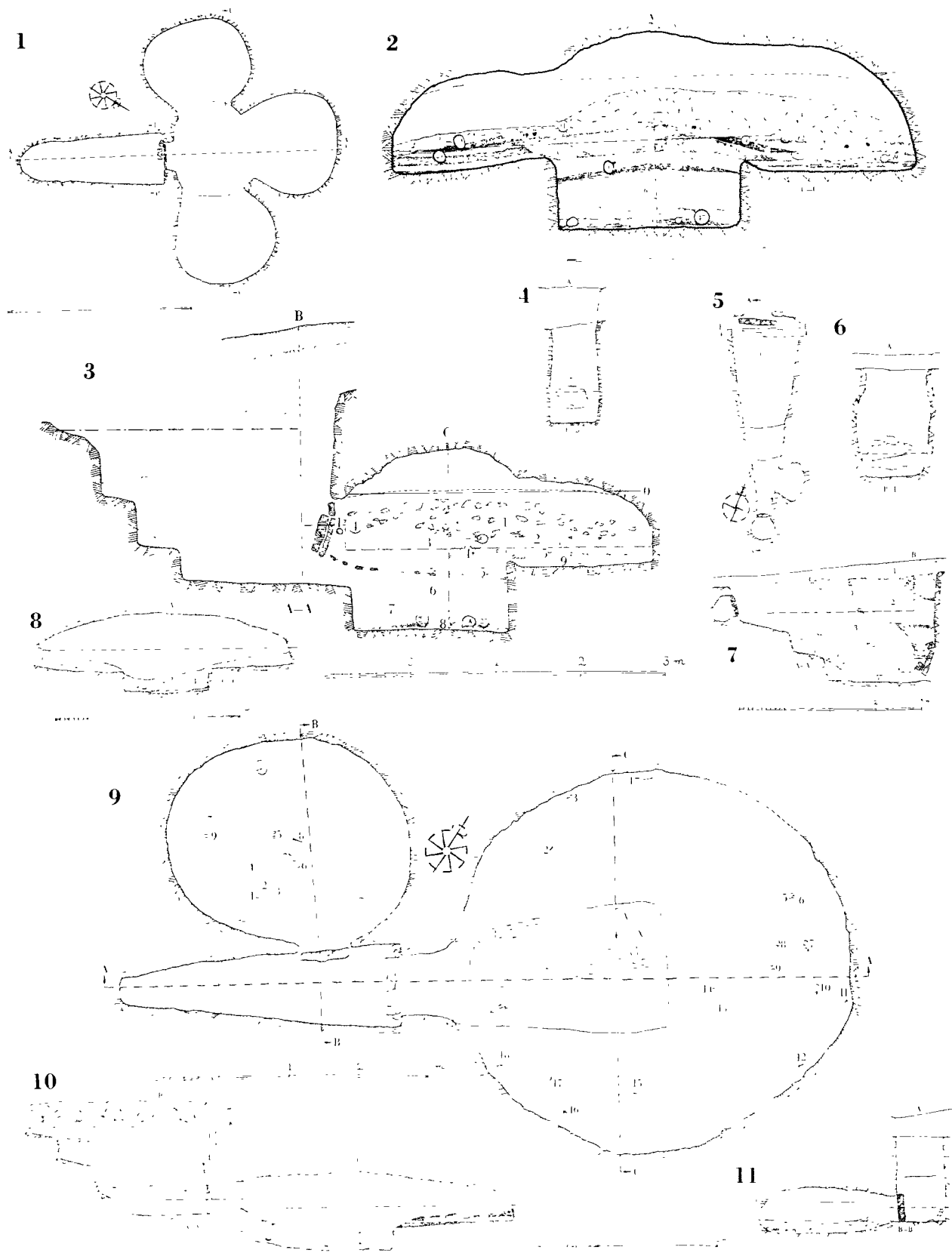

Fig. 126. Ajos Jakovos. Tomb 8, Plan (1); Sections C-C, A-A, B-B (2, 3, 4). Tomb 9, Plan (5); Sections B-B, A-A (6, 7). Tomb 10, Section C-C (8); Plan (9); Sections A-A, B-B (10, 11).

earth, *chavara*, and stones. The pit starts from the level of the rock which now is covered by a layer of field earth, about 1.00 m. thick. This layer has accumulated since the pit was dug, a circumstance that dates the pit to a rather remote period: the filling of the shaft contained exclusively Bronze Age pottery and mainly Late Cypriote wares, which are an indication of its date. The dromos stratification indicates repeated burials, verified by the stratigraphical conditions of the chamber.

There, the filling had a maximum thickness of approx. 1.55 m. and consisted of the following layers, counted from the top:—

- 1) A layer of debris from the roof consisting of fine *chavara*, mixed with some larger blocks. The layer was spread all over the chamber.
- 2) A burial layer of culture earth containing skeletal remains and finds. The layer was found all over the chamber and rested on a thin stratum of sand and *chavara*.
- 3) A dark stratum of clayey earth of sticky consistency. It was found in the central area of the chamber, in the frontal niche, and partly in both the side niches. It reached its greatest thickness (about 0.25 m.) in the centre.
- 4) A layer of disturbed burial remains around the edges of the central shaft.
- 5) A burial layer in the centre of the chamber consisting of one stratum with skeletal remains resting on a floor of gravel and *chavara*, and one stratum of brown culture earth, emanating from various organic matters. This layer was also found in the niches, but there it was much thinner.
- 6) A thick, slightly damp layer of clay and culture earth in the central pit.
- 7) A hard layer of light coloured clay covering the same area as Layer 6.
- 8) A burial layer of the same composition as Layer 5. The bottom of this layer rested directly on the rock, and was confined to the centre of the chamber.
- 9) Bottom strata in the niches. They consisted mainly of weathered rock, but in the left, or W., niche some tiny remains of a burial could be traced.

It is clear without further comment that Layers 2, 5, and 8 represent three different burial periods. When the chamber was used for the first time, the niches and the central pit were used. As a matter of fact, very little was left of the layers in the niches, (Layer 9), but as Layer 8 contained nine skulls (Nos. IV—V, VII—IX and XIX—XXII) it can be concluded that the niches also must have been used for burial purpose, as there was no space for nine burials in the central pit alone. When the chamber was thus filled, it was cleaned and prepared for new burials. Tomb-gifts and skeletal remains in the niches were removed and swept down into the central basin, and together with the original burial stratum they formed Layer 8. This was covered by a layer of white clay (Layer 7), and only in the left niche some burial earth was left. All the niches were strewn with white broken rock, and after this process the tomb was ready for receiving new burials. In and below the bottom strata of the niches (Layer 9), some small objects were found lying on the floors (Nos. 65—67, 74, 81—83, and 85—93). They must be earlier than the second burial period, represented by Layer 5 in the niches, and must be assigned to the first burial period, having remained in their proper positions at the cleaning of the tomb after this epoch.

Before the second burial period began, the silted clay layer (Layer 6) was gradually accumulated. In this layer was found the single pot, No. 44. It seems reasonable to suppose that this vase belongs to the first group, and has been brought to its present level by means of the water and wet clay which had intruded into the central basin in the interval. To the ten bodies of the first burial period belong the above-mentioned finds and Objects Nos. 20—24, 41 and 45—53.

The second burial period is characterized by a floor layer in the central basin, laid above the silted clay layer. Near the stomion, the level of this floor coincides with the foot of the door-packing and the top of the bottom layer of the dromos. On this floor rested Layer 5, which also extended into the niches (cf. above), and comprised a considerable amount of culture earth. Partly mixed with the culture earth, and partly covering the intact burial layer, was Layer 4, which must, consequently, be slightly later than Layer 5, but still precede the third burial period, represented by Layer 2. It contained no finds, but several disturbed skeletal remains. It can be considered as a later sub-period of the second burial epoch, and was, apparently, laid in its present position when the chamber was prepared for subsequent burials. The whole second period was extremely rich in bodies, but the tomb-gifts were very few. Fragments of 35 skeletons were found, the skulls of which were remarkably well preserved. The finds attributable to the period are Nos. 9, 10, 13, 32, 42, 43, 59—61, 63, 64, 70, 72, 73, and 78—80. This distribution is made by means of the levels of the objects.

The third, and last time, that the chamber was used, it was also prepared by special arrangements. First the area was levelled by laying down Layer 3 as filling material, and afterwards a thin *chavara* floor was spread over the filling. On top of this, Layer 2 containing the last burials, was found. The level of the floor stratum starts from the top of the inner door slab (cf. above p. 327). There were traces of eighteen bodies in the stratum, and the finds assignable to these were Nos. 1—8, 11, 12, 14—19, 27—31, 33—40, 54—58, 62, 68—69, 71, and 75—77. Of these Nos. 1—7 actually blocked the doorway, and are, consequently, the latest objects brought into the tomb.

BURIALS

An analysis of the skeletal material of the two earlier epochs does not give any great result. Layer 8 contained, except for the skulls, very few bones. None of them were found *in situ*, as they had been more or less disturbed when the chamber was prepared for the second burial period. As mentioned above, the second burial layer was also partially removed, and only in the central basin some skeletons were found fairly untouched. In a very limited area in the same stratum, lay five skeletons all in dorsal position and partly on top of one another. None of them was completely preserved, and they gave the impression of having been literally piled up on top of one another. The eleven bodies in the left niche (Nos. XLIII, XLV—XLIX and LII—LVI) must have been deposited in a similar way.

Of the eighteen bodies of the last burial period eight were well enough preserved to

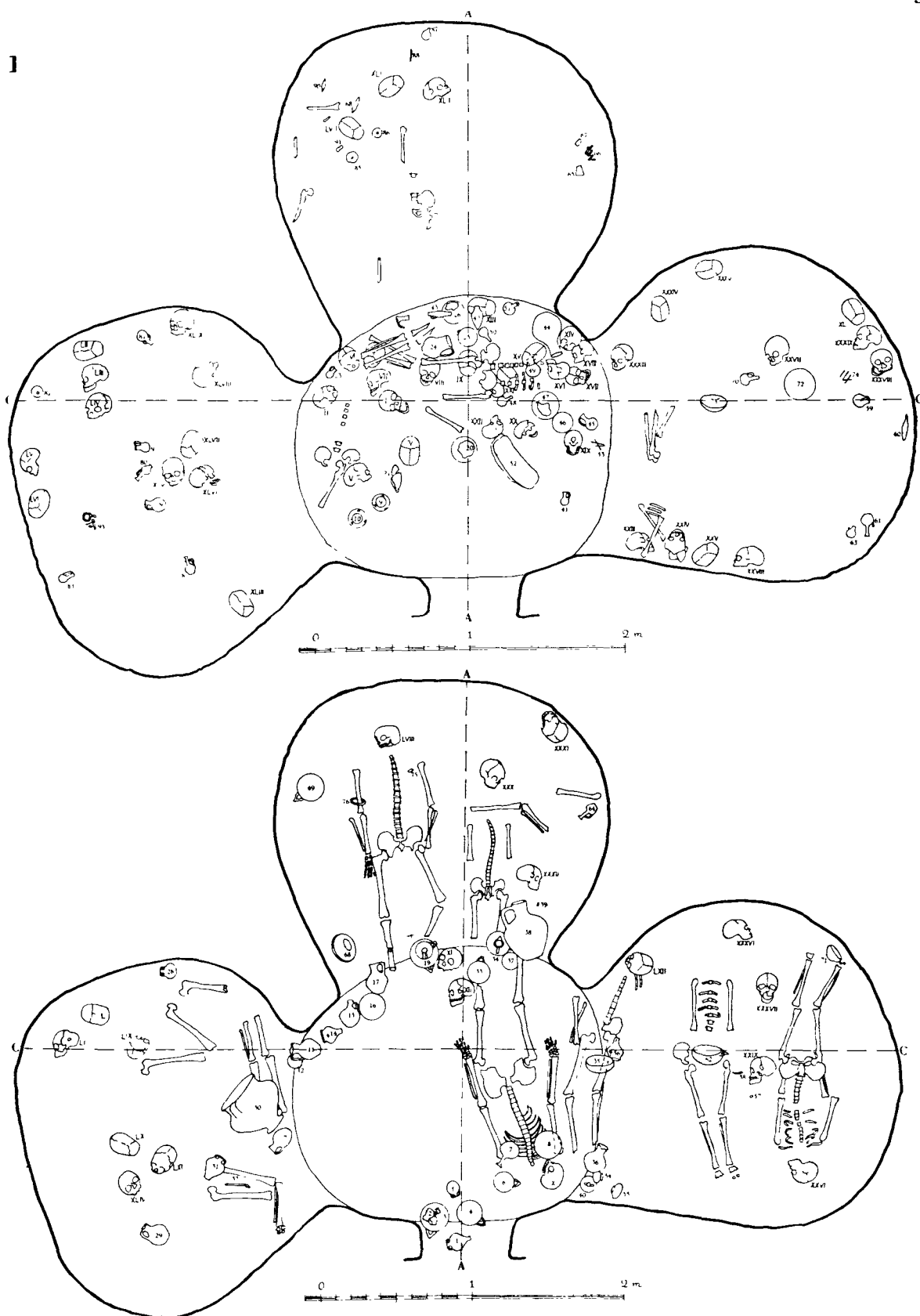

Fig. 127. Ajos Jakovos. Tomb 8, Finds *in situ* of the first and second periods (1), and of the third period (2).



Fig. 128. Ajios Jakovos. Tomb 8, Finds Nos. 1-7 *in situ*.



Fig. 129. Ajios Jakovos. Tomb 10, dromos.

allow one to draw conclusions with regard to their original positions. They have all been deposited on their backs in outstretched positions with the arms by their sides. The rest of the skeletal material was very fragmentary.

Summing up the account of the burials and numbering them, according to the plan (Fig. 127), the following statements can be made: —

To the first period belong the bodies Nos. IV—V, VII—IX and XIX—XXII. They were found in the central basin, evidently swept down from the niches and not *in situ*. Practically only the skulls were preserved.

The second burial period is characterized by mass-burials with a few tomb-gifts. Thirty-five bodies in a more or less fragmentary state were found. They were Nos. I—III, VI, XIII—XVIII, XXIII—XXV, XXVII—XXVIII, XXXIII—XXXV, XXXVIII—XLIII, XLV—XLIX and LII—LVII. Especially in the right, or. E., niche some of the skulls were found on a slightly higher level than the stratum to which they belonged, as they had been removed and placed along the walls of the niche.

The third period was represented by eighteen bodies (Nos. X—XII, XXVI, XXIX—XXXII, XXXVI—XXXVII, XLIV, L—LI and LVIII—LXII). The fairly well preserved skeletons Nos. X, XXVI, XXX, XXXVI, XXXVII, LVIII—LIX, and LXII had been buried in outstretched, dorsal positions, but about the rest, nothing could be stated for certain.

In all sixty-two burials were traced in the tomb, and most of the skulls were in a good enough state of preservation for anthropological investigations.

FINDS (GROUPS: PLS. LXII, 2, LXIII, I; TYPES: L. OF PL. II)

1. Levanto-Helladic tall, piriform stirrup-vase. Encircling lines round rim, neck, belly, and body; red handles and base: cross-hatchings on knob, and continuous spirals on shoulder. Lustrous paint. Height 16.0. — 48.
2. Levanto-Helladic globular bottle with base-ring; narrow, concave neck; splaying rim, and two handles from neck to shoulder. Vertical spirals on both sides of body; hatchings and chevrons below handles, and encircling lines around rim and neck. Much damaged, lustrous paint. Height 14.7. Found inside No. 3.
3. White Slip II hemispherical bowl with somewhat bent rim, and a wish-bone handle below rim. A ladder-pattern frieze around rim; hanging bands of similar pattern from rim to base; and smaller, dotted and ladder-pattern stripes in their interstices; transverse lines on handle. Diam. 19.7. — 48.
4. White Slip II bowl, as No. 3. Paint much worn. Diam. 16.4. — 48.
5. Levanto-Helladic bottle, as No. 2, but with depressed, oval body. Encircling lines around rim, neck, shoulder, belly and base, red handle. Lustrous paint. Height 11.1. — 48.
6. White Slip II bowl, as No. 3, but instead of the ladder-patterns are parallel lines. Diam. 14.3. — 56.
7. Base-ring I globular jug with flat base; tall, tapering neck; distinct funnel-rim, and handle from neck to shoulder. Body decorated with vertical relief-lines; horizontal relief-lines around neck. Height 17.0. — 56.
8. White Slip II bowl, as No. 3. Diam. 18.7. — 51.
9. Base-ring I squat bowl with flattened base; short, concave neck; wide, profiled rim, and three string-hole projections on shoulder. A dotted line on rim, and framed dotted bands on shoulder. White paint on grey ground. Diam. 10.9. — 108.
10. Base-ring I bowl, as No. 9, but with chevrons on shoulder. Diam. 12.0. — 106.
11. Plain White Wheel-made biconical jug with flat base; pinched mouth, and handle from rim to shoulder. Height 17.3. — 54.
12. Monochrome shallow bowl with round base; raised, contracted rim, and a wish-bone handle below rim. Diam. 10.6. — 55.
13. Thick ivory pin ending in a carved pomegranate. Broken. Found inside No. 10.
14. Levanto-Helladic piriform amphora with high base; short neck; stilted rim, and two horizontal handles on shoulder. Encircling lines around rim, neck, shoulder, belly, and base; black handles and base; a frieze of small N-shaped figures between the handles. Mat paint. Height 12.9. — 60.
15. Plain White Wheel-made oval jug with flat base; cylindrical neck; stilted rim, and handle from neck to shoulder. A ridge below neck. Height 18.5. — 61.
16. White Slip II bowl, as No. 3, but with double friezes around rim. Diam. 17.5. — 58.
17. Plain White Wheel-made jug, as No. 11. Height 19.7. — 55.
18. Base-ring II shallow bowl with concave, angular outline; bent rim, and a hooked, horned handle near the rim. Diam. 11.8. Found inside No. 19.
19. White Slip II bowl, as No. 3. Diam. 19.5. — 53.
20. White Painted Wheel-made squat jug with base-ring; wide, concave neck; splaying rim, and handle from rim to shoulder. Bands filled with a zigzag line around rim, neck, and belly; encircling lines below neck and belly; a frieze of alternating oblique lines on shoulder; dots on rim. Pieces of neck, rim, and handle missing; purple paint on reddish, smooth slip. Height 15.0. Floor.
21. Red-on-Black shallow bowl with round base; bent rim, and a horizontal loop-handle on rim. Bands of parallel lines crossing the bottom, both within and without. Shorter bands in their interstices. Transverse lines on handle. Damaged. Diam. 11.3. Floor.
22. Thin bronze needle. Damaged. Length c. 11.7. Floor.
23. Black Slip II globular jug with wide, concave neck; splaying rim, and a raised handle from rim to shoulder. Height 8.3. Floor.
24. White Painted Wheel-made jug, as No. 20, but with slightly tapering neck. A line of dots on rim; framed, vertical bands and zigzag lines, alternating with vertical, wavy lines on neck. Body decorated as No. 20. Brownish paint on white, smooth ground. Height 17.3. Floor.
25. Red-on-Black bowl, as No. 21, but with flat base; concave, out-turned rim, and horizontal handle. Diam. 12.0. Floor.
26. Red-on-Red globular jug with round base; tall, concave neck; splaying rim, and handle from rim to shoulder. Groups of short, horizontal lines all over the body, transverse lines on handle. Bright pink ground and purple decoration. Height 24.0. Floor.
27. Plain White Wheel-made jug, as No. 29, but with a ridge below neck. Height 16.7. — 67.
28. Levanto-Helladic squat, globular stirrup-vase with base-ring. Encircling lines around rim, neck, belly, and body, red handles, and an encircled dot on the knob. Height 9.8. — 68.
29. Plain White Wheel-made jug, as No. 11, but with globular body. Height 16.5. — 69.
30. Plain White Wheel-made depressed, oval crater on low foot with base-disc; short, widening neck; wide, horizontal rim, and two profiled handles from neck to shoulder. Height 32.3. — 61.
31. Levanto-Helladic piriform, tall stirrup-vase; decorated as No. 1, but with a spiral on the knob, and concentric circle-sectors on shoulder. Height 17.1. — 63.
32. Fragment of the ivory pin No. 13. — 72.
33. White Slip II bowl, as No. 3, but shallower; decorated as No. 6. Diam. 15.0. — 59.
34. Plain White Wheel-made jug, as No. 11. Height 23.0. — 59.

35. White Slip II bowl, as No. 3. Diam. 18.0. — 59.
36. Plain White Wheel-made jug, as No. 11. Height 19.0. — 60.
37. Fragments of a Plain White Wheel-made bowl. — 60.
38. Plain White Wheel-made biconical jug with flat base; widening neck; ridges below neck and rim, and handle from neck to shoulder. Height 35.0. — 60.
39. Plain cylinder of stone; not engraved. Length 2.2. — 64.
40. Levanto-Helladic bottle, as No. 2, but with concentric circles, instead of spirals. Height 15.4. — 52.
41. Red-on-Black globular jug with concave, slightly backwards-leaning neck, and handle from rim to shoulder. Paint almost obliterated. Height 8.4. — 143.
42. White Shaved bobbin-shaped bottle with pointed base; slightly backwards-leaning neck; somewhat pinched mouth, and a raised handle from rim to shoulder. Height 15.7. — 83.
43. Base-ring I tall bottle with tapering neck; funnel-rim, and handle from neck to shoulder. Mottled, pink surface. Height 14.6. — 83.
44. Red-on-Black globular jug with flat base; concave neck; splaying rim, and handle from neck to shoulder. Bands of parallel lines around neck and belly; squares of crossed lines on shoulder and below handle; transverse lines on handle. Height 27.7. — 120.
45. Red-on-Black jug, as No. 41. Height 12.5. Floor.
46. Red-on-Red squat jug with round base; tall wide, concave neck; splaying rim, and a knobbed handle from rim to shoulder; decorated as No. 26. Bright, pink ground and purple decoration. Damaged. Height 21.2. Floor.
47. Red-on-Red jug, as No. 26. Neck missing. Height 23.2. Floor.
48. Red-on-Black jug, as No. 41. Handle missing; rim chipped; paint much worn. Height 10.2. Floor.
49. Red-on-Black jug, as No. 41. Paint much worn. Height 14.0. Floor.
50. Red Polished IV pear-shaped bottle with tall, tapering neck; splaying rim, and two small handles from neck to shoulder. The body is decorated with punctured bands from neck to base. Rim chipped; pieces of rim and body missing; paint worn. Height 10.2. Floor.
51. Black Slip III globular jug with flat base; tall, tapering neck; wide funnel-rim, and handle from neck to shoulder. Body decorated with broad, vertical lattice-bands. Chipped here and there; handle missing; paint obliterated. Height 13.3. Floor.
52. Flat, curved grinder of dolerite. Length 37.2. Floor.
53. Two thin bronze needles with pointed ends, and an eyelet at top. Length 10.2; 9.2.
Thin, hooked bronze needle with a spiral-shaped eyelet. Length 9.6. Floor.
54. Levanto-Helladic squat pyxis with flat base, and two horizontal handles. Encircling lines around rim, neck, body, and base; black handles. Lustrous paint. Diam. 8.9. — 62.
55. Levanto-Helladic pyxis, as No. 54, but with three handles. Encircling lines around rim, neck, body, and base; a wavy pattern around belly, and dotted stars between handles. Lustrous paint. Diam. 11.2. — 64.
56. Levanto-Helladic amphoriskos, as No. 14. Encircling lines around rim, neck, shoulder, belly, and base. Lustrous paint. Height 12.0. — 73.
57. Plain, circular finger-ring of bronze. Broken into three pieces. Diam. 2.2. — 78.
58. Fragment of a bronze bracelet. Length c. 9.4. — 60.
59. Red-on-Black globular jug with round base; concave neck, and a raised handle from rim to shoulder. Parallel, wavy lines around shoulder, and vertical, wavy lines below and opposite the handle. Height 10.0. — 97.
60. Leaf-shaped bronze knife with midrib; rounded end, and solid tang. Length 16.8. — 99.
61. Base-ring I globular jug with tall, tapering neck; funnel-rim, and handle from neck to shoulder. Vertical, relief-lines on body, and a string-ornament around neck. Height 14.0. — 96.
62. White Slip II bowl, as No. 3. Diam. 18.0. — 73.
63. Black Slip II oval jug with round base; wide, cylindrical neck, and handle from rim to shoulder. Handle missing; paint obliterated. Height 7.4. — 96.
64. Black Slip III jug, as No. 51. Horizontal bands of zigzag lines around body. Height 12.5. — 70.
65. Small bronze axe with straight edge. Length 5.7. Floor.
66. Thin, plain bronze pin. Length 10.2. Floor.
67. Two fragments of bronze leaf. Floor.
68. Plain White Wheel-made shallow bowl with base-ring, and small, stilted rim. A tubular, horizontal string-hole on rim. Diam. 19.4. — 62.
69. White Slip II bowl, as No. 16. Diam. 18.7. — 58.
70. Base-ring I jug, as No. 61, but with spiral reliefs on body. Base-ring and mouth missing. Height 13.8. — 90.
71. Monochrome conical bowl with flat base; bent rim, and a horizontal wish-bone handle near the rim. Diam. 12.0. — 62.
72. Plain White Wheel-made shallow bowl with flat base. Diam. 19.6. — 90.
73. Plain White Wheel-made bowl, as No. 72, but with a string-hole projection at rim. Diam. 17.2. — 91.
74. Fragments of bronze pins. Floor.
75. Fragments of a bronze knife. — 56.
76. Circular bronze bracelet with overlapping ends. Broken into two pieces. Diam. 10.2. — 53.
77. Plain stone cylinder. Length 2.8. — 59.
78. Black Slip III depressed jug with tall, narrow neck; splaying rim; flattened base, and a profiled handle from neck to shoulder. A framed frieze of zigzag lines on shoulder, and a similar one above base. A relief-ornament around neck. Height 11.5. — 85.
79. Black Lustrous Wheel-made globular jug with rounded base; cylindrical neck; splaying rim, and handle from rim to shoulder. Height 13.2. — 85.
80. Base-ring I jug, as No. 61, but with narrow base-ring. Height 13.6. — 81.

the beginning of Late Cypriote I. Some Middle Cypriote wares still survive (Nos. 59, 63, 64, and 78), but the main feature of the group is the introduction of Base-ring I Ware. The imported vases are Plain White and Black Lustrous. This was the period of the mass-burials. The striking characteristic of the third group is the presence of the quantity of Levanto-Helladic Ware, going back to Late Helladic III types. This fact dates the last burials of the tomb to Late Cypriote II times.

To complete the survey of the contents of the tomb an analysis of the potsherds of the different layers were made. The result can be studied in the diagram:

		Hand-made									Wheel-made				
		Bl. Sl. II	Red Slip	Red-on-Black	Red-on-Red	Pl. Wh.	Wh. P. IV	Wh. P. V	Base-ring	Wh. Slip	Wh. P.	Pl. Wh.	Bl. lustrous	Levanto-Helladic	Total
Layer 8	Number of sherds	4	1	9	1	—	2	—	—	—	—	—	—	—	17
	Percentage	23.4 %	5.9 %	53.0 %	5.9 %	—	11.8 %	—	—	—	—	—	—	—	100 %
Layer 6	Number of sherds	46	14	42	14	—	2	—	—	—	—	26	2	—	146
	Percentage	31.4 %	9.6 %	28.8 %	9.6 %	—	1.4 %	—	—	—	—	17.8 %	1.4 %	—	100 %
Layer 5	Number of sherds	14	15	32	4	2	—	—	12	9	4	16	—	—	108
	Percentage	13.0 %	13.9 %	29.7 %	3.7 %	1.8 %	—	—	11.2 %	8.3 %	3.7 %	14.7 %	—	—	100 %
Layer 3	Number of sherds	15	4	17	—	—	—	2	2	10	—	16	—	2	68
	Percentage	22.0 %	5.9 %	25.0 %	—	—	—	2.9 %	2.9 %	14.8 %	—	23.6 %	—	2.9 %	100 %
Layer 2	Number of sherds	—	—	—	—	—	—	—	—	—	—	—	9	3	12
	Percentage	—	—	—	—	—	—	—	—	—	—	—	75.0 %	25.0 %	100 %

For the burial layers (Layers 2, 5 and 8) the statistics of the sherds show the same features as those demonstrated by the summary of the Object Register, viz., only Middle Cypriote sherds in the bottom layer; mixed Middle and Late Cypriote sherds in the middle layer, and only Late Cypriote sherds in the top layer. The intermediate strata containing potsherds were Layers 3 and 6. The former was brought into the chamber as filling material during the preparations for the third burial period, and contained more than 50 % of Middle Cypriote sherds, which emphasizes its early date in the Late Cypriote I period.

Layer 6 played a similar role between the first and the second burial period. Here, too, the sherds assign the layer to the older period, i. e., Middle Cypriote III, although the considerable percentage of wheel-made wares announces the end of the epoch.

TOMB 9 (Fig. 126: 5—7)

	SIZE			
	Length	Width	Depth	Height
Dromos	4.38	1.47	2.34	—
Cupboard 1	0.60	0.83	—	0.52
Cupboard 2	0.48	0.52	—	0.55

SHAPE

The dromos was the only part of the tomb entirely excavated. It showed the same exterior as the majority of the tombs of the site, i. e., a widening passage with steps at the narrow back end, and a slightly sloping section in front of the stomion. The front is perpendicular, and it seems probable that the long sides were also vertical, but because of the erosion of the rock the sides spread outwards at the time of the excavation. The door-packing was founded in the loose earth, and consisted of several stones piled up without any distinct order. At the back of the dromos, was a small cupboard on the right side. It was of oval shape with a slightly sunken floor and a low, curved roof. Another similar cupboard lay at the end of the dromos. The door-packing of the latter consisted of a thin slab of local limestone.

STRATIFICATION

Because of the extremely unfavourable stratigraphical conditions, the excavation of the tomb was stopped. The layers in the dromos were observed and the stratification was from the top, as follows:

- 1) A deep shaft in the front part of the dromos filled with field earth, *chavara*, and stones.
- 2) A layer of similar consistency, covering the whole dromos, but partly cut through by Layer 1.
- 3) Horizontally stratified *chavara*.
- 4) A layer of coarse *chavara* mixed with potsherds and some culture earth.

Layer 1 showed the way in which modern tomb robbers had attempted to sack the tomb. That they also entered the chamber, could be traced both in the carelessly piled up door-packing and in the great disorder of the earth-filling of the tomb. Layer 2 held several Byzantine potsherds. From this circumstance and from the loose consistence of the stratum it could be concluded that robbers had also payed a visit to the tomb in that epoch. These facts of course made it clear that further excavation of the tomb was purposeless.

The one cupboard, however, was found intact and contained a few pots (Nos. 1—5). From the potsherds in the dromos two bowls and one jug could be put together. They are added to the Object Register as Nos. 6—8.

FINDS (GROUP: PL. LXII, 2; TYPE: L. OF PL. II)

1. Red-on-Black shallow bowl with round base, and a horizontal loop-handle at rim. Wavy lines crossing the bottom at right angles, both within and without. Diam. 9.3. Floor.
2. White Painted IV globular jug with round base; tapering neck; splaying rim, and a small handle from neck to shoulder. Encircling lines around rim and neck; large lattice-triangles from neck to belly, and a base-decoration of crossed, parallel lines with radiating, wavy lines in the angular interstices; black handle. Height 11.2. Floor.
3. Red-on-Black bowl, as no. 1, but with a knobbed, horizontal handle at rim. Diam. 14.2. Floor.
4. Three circular hair-rings of bronze with overlapping ends. Diam. 1.8.
Six spherical beads of white faience. Diam. 1.1—1.5. Floor.
5. Red-on-Red bowl, as no. 1. Piece of handle missing. Diam. 9.7. Floor.
6. Red Polished IV deep bowl with round base; in-turned rim, and a large string-hole projection on rim. Opposite the string-hole projection there may have been a semicircular spout. Not complete. Diam. 12.7.
7. Shallow bowl of Composite Ware (Black Slip II and White Painted IV) with round base, and a string-hole projection below rim. The outside of the bowl is covered with a black slip, and the inside decorated with crossed, wavy lines. Diam. 16.0.
8. White Painted IV globular jug with round base; narrow, cylindrical neck; splaying rim, and handle from rim to shoulder. Short, horizontal lines around neck; body covered with bands of zigzag ladder-patterns, and lattice-squares; crossed ladder-pattern stripes on base; transverse lines on handle. Height 22.3.

Summing up the Object Register, we obtain the following diagram:

	P o t t e r y					Bronze	Faience
	R. P. IV	R.-on-Bl.	R.-on-R.	Wh. P. IV	Bl. Sl. II + Wh. P. IV	Hair-rings	Beads
Cupboard		1. 3	5	2		4. 4. 4	4. 4. 4
		-2	-1	-1		-3	4. 4. 4 -6
Dromos	6 -1			8 -1	7 -1		

CHRONOLOGY

As the evidence of these few objects is rather limited as regards the dating of the whole tomb, a statistical survey of the potsherds found in the intact layers of the dromos (Layers 3 and 4) was made. Proportions and distributions of the different wares are shown in the summary below: —

	H a n d - m a d e							Wheel-made			Total
	R. P. IV	R. Sl.	Bl. Sl. II	Pl. Wh.	R.-on-Bl.	R.-on-R.	Wh. P. IV	Light-on-Dark	Pl. Wh.	Wh. P.	
Number of sherds	23	25	85	48	26	4	12	3	18	2	246
Percentage	9.8 %	10.2 %	34.5 %	19.4 %	10.6 %	1.6 %	4.8 %	1.2 %	7.3 %	0.8 %	100 %

The greatest quantity is the Black Slip II Ware, flanked on one side by the Red Polished IV and Red Slip classes, and on the other by the wares of later types, i. e., Red-on-Black, Red-on-Red, Plain White Hand-made and White Painted IV Wares. Of peculiar interest are the sherds of the Light-on-Dark class which link the tomb to the Middle Cypriote III tombs of the Carpass peninsula. The considerable amount of Plain White Wheel-made sherds strengthen the dating of the tomb to the later section of this period.

TOMB 10 (Figs. 126: 8—11; 129)

	SIZE			
	Length	Width	Depth	Height
Dromos	4.06	1.21	1.84	—
Stomion A	0.73	1.03	—	0.69
Chamber A	5.72	5.46	—	1.69
Stomion B	0.11	0.74	—	0.58
Chamber B	2.94	3.45	—	0.99

SHAPE

The dromos is a narrow passage, widening towards the entrance of the chamber. The cutting is very careful with exact angles and square corners. The sides are vertical and the floor in front of the stomion finely smoothed and horizontal. From the back part of the dromos, two rectangular steps are cut, and end in a sloping area which leads down to the horizontal platform in front of the door. Two chambers open from the dromos, one in the longitudinal axis (Chamber A), and one in the transverse axis in the left side wall (Chamber B).

Chamber A was closed by a large slab of black, heavy stone standing in upright position, and wedged along the perpendicular sides with small chips of local limestone. The stomion is a sloping tunnel ending in a low step. Inside the stomion is a trapezoid basin lying about 0.50 m. below the rest of the chamber floor. The floor is horizontal both in the basin and in the raised parts of the chamber, and the roof is a very low vault, the curve of which starts almost from the edge of the floor, and reaches its apex in the centre of the chamber. In the N. corner of the chamber, wall and roof are pierced by a hole, about 1.15 m. in diameter. It leads out to the dromos of Tomb 14 which is cut through on the floor of the lowest step in the dromos. It is evident that the communication was not established on purpose, as no marks of tools were found around the edges of the hole, and it cannot even be definitely stated which of the tombs is the older, from a structural point of view (cf. below p. 349.).

Chamber B was blocked with a single thick slab of calcareous stone, surrounded by small chips. The stomion is very short, and slopes gently down to the level of the horizontal floor. The chamber is approximately circular with a low, slightly curved roof.

STRATIFICATION

The dromos-filling consisted of three layers of horizontally stratified *chavara*, all apparently intact and containing practically no potsherds. A layer of dark, moist earth of loose consistency followed the front side of the dromos, going right down to the upper part of the door stone. Its width was about 0.35 m. and its maximum thickness about 0.60 m. It cannot be interpreted as a trial digging of tomb robbers, and nobody can have entered the tomb by this route. Probably it was caused by rain-water which has followed the rock, and found its outlet in the dromos.

The chamber contained very little earth. The filling was divided into the following layers: —

- 1) A thin layer of debris from the roof spread all over the chamber.
- 2) A conical layer of dromos earth found in the back part of the chamber. It had intruded through the hole in the roof leading to the dromos of Tomb 14.*
- 3) A fan-shaped layer of finely pulverized dromos-filling, found in the stomion.
- 4) A layer of dry, silted clay in the central basin.
- 5) A thick burial layer in the central basin. It rested partially on a thin layer of sand.
- 6) A stratum consisting of mixed culture earth, *chavara* debris, and burial remains covering the raised area of the chamber. It rested to a limited extent on a sandy bottom layer, and was, in the left side of the chamber, split up into two strata, separated by debris from the roof.

The roof debris (Layer 2) has accumulated mainly after the communication with the dromos of Tomb 14 was established. When that happened, the deposits lay open to the intruders except for the intact burial layer (Layer 5) which was covered by the silted clay stratum (Layer 4). The deposits in the raised parts of the chamber were, apparently, thoroughly sacked, and only some small objects were left. Not even potsherds were found in the disturbed layers. If there were any vases among the tomb-gifts, they must have been carried off.

The central basin contained the remains of ten skeletons and only one small jug. The tomb, therefore, shows the same feature as the second burial period of Tomb 8 (cf. above p. 330), i. e., mass-burials with comparatively few tomb-gifts.

Chamber B was very well preserved. It contained a stratum of culture earth mixed with burial remains, covered by a thin layer of debris from the roof and some dromos-filling, which had intruded through the door-packing. The chamber only contained some small bronzes and three skulls, which were not *in situ*.

The deposits of the chamber were disturbed and sacked, but the door stone was *in situ* and the dromos-filling intact. Consequently, the chamber must have been raided before the dromos was filled up. After the sacking, the door slab was carefully replaced. This circumstance makes the robbery contemporaneous with some of the later burials in Chamber A. Perhaps the chamber was only prepared for secondary burials, which for some reason, never took place.

* The layer is not visible on the sections.

BURIALS

The only skeletal material which can be analysed are the remains of the ten bodies in the central basin of Chamber A. They were all lying transversely in the pit, and are numbered from the door I—X. No. I is the best preserved. It rested in an outstretched, lateral position on its left side with the head towards the left of the basin. No. X was lying near the back wall of the pit. Only femora, tibiae, and pelvis were preserved, but they showed that the body had been deposited in a dorsal, outstretched position with the head towards the right side of the basin. The fragments of the rest of the skeletons indicate similar positions, and they have been buried partly on top of each other.

FINDS (GROUPS: PL. LXIII, 2, 3)

Chamber A

1. Base-ring I globular jug with tall, tapering neck; funnel-rim, and handle from neck to shoulder. Vertical relief-lines on body, and around neck. The longitudinal axis of the jug is leaning backwards. Height 15.0. Floor.
2. Bronze tweezer with loop-shaped top. Length 7.5. Floor.
3. Leaf-shaped, double-edged bronze knife with midrib; concave sides, and rounded top with two rivet-holes. Length 9.9. Floor.
4. Narrow, double-edged, leaf-shaped bronze dagger with midrib, and hooked, solid tang. Length 27.3. Floor.
5. Black Slip II oval jug with round base; wide, bulging neck; small rim, and raised handle from rim to shoulder. Height 7.3. — 14.
6. Cylindrical whetstone of grey stone, pierced by a hole from top to side. Length 4.5. — 14.
7. Base-ring I jug, as No. 1. Height 15.7. — 14.
8. Base-ring I biconical jug with wide, tapering neck; horizontal rim, and high, horned handle from rim to shoulder. The longitudinal axis leaning backwards. Height 8.1. — 20.
9. Plain White Hand-made sack-shaped jug with concave, widening neck; pinched mouth, and handle from rim to shoulder. Height 10.7. — 28.
10. Base-ring I jug, as No. 1. Relief-spirals as front ornament, and a ridge around neck. Height 14.6. — 15.
11. Black Slip II jug, as No. 5, but with cylindrical neck. Height 6.6. Floor.
12. Base-ring I jug, as No. 1. Height 13.4. — 28.
13. Leaf-shaped miniature, double-edged bronze knife with midrib; rounded top, and three rivets. Length 6.7. — 30.
14. Bronze tweezer, as No. 2. One arm broken. Length 8.2. — 24.
15. Black Slip II jug, as No. 5. Height 8.0. Floor.
16. Red-on-Black shallow bowl with round base; raised, contracted rim, and a horizontal handle on rim. Bands of parallel lines crossing the bottom at right angles, both within and without; short lines in their interstices. Diam. 12.0. Floor.
17. Black Slip III globular jug with flat base; tall, narrow neck; funnel-rim, and handle from neck to shoulder. Two framed, incised friezes of horizontal zigzag lines around body. Height 12.5. — 30.
18. Black Slip III jug, as No. 17. Surface much worn; handle missing. Height 11.7. Floor.

Chamber B

1. Circular bronze bracelet with overlapping ends. Diam. 7.2. — 50.
2. Bronze bracelet, as No. 1. Diam. 7.0. — 50.
3. Plain, circular bronze bracelet. Diam. 6.5. — 50.
4. Circular, small bronze bracelet with overlapping ends. Diam. 5.0. — 61.
5. Two spiral finger-rings of bronze. Diam. 2.4. — 59.
6. Bronze axe with fan-shaped edge and flat top. Length 14.3. — 56.
7. Leaf-shaped, double-edged bronze knife with midrib, and slightly concave sides. Top broken. Length c. 15.0. — 53.
8. Straight bronze awl with square section; broken. Length 15.8. — 56.
9. Bronze tweezer with rounded top. Broken into two pieces. Length 9.1. — 40.

A summary of the Object Register and a distribution of the finds between the different classes, gives the following diagram:

	P o t t e r y					B r o n z e					Stone		
	Bl. Sl. II	Bl. Sl. III	R.-on-Bl.	Pl. Wh.	Base-ring I	Dagger	Axe	Knives	Awl	Tweezers	Rings	Bracelets	Whetstone
Chamber A	5, 11 15	17, 18	16	9	1, 7 8, 10 12	4		3, 13		2, 14			6
	-3	-2	-1	-1	-5	-1		-2		-2			-1
Chamber B							6	7	8	9	5, 5	1, 2 3, 4	
							-1	-1	-1	-1	-2	-4	

CHRONOLOGY

The proportions between the Middle and the Late Cypriote wares date the tomb to the beginning of the Late Cypriote I period. This epoch is in this tomb, as well as in Tomb 8, characterized principally by poor mass-burials.

TOMB 11 (Fig. 130: 1, 2)

SIZE

	Length	Width	Depth
Dromos	3.81	0.99	2.56

SHAPE

Of this tomb only the dromos was excavated. It was of the usual type with three steps at the narrow back end, and a oblong, sloping area in front of the stomion. The sides taper slightly downwards. Of the door-packing, one slab was found over-turned on a high level in front of the door, and the rest inside the chamber. This is a sure proof that the chamber has been entered by tomb robbers. The manner in which they entered the chamber is clearly shown by the layers of the dromos-filling.

STRATIFICATION

The dromos was filled with four horizontally stratified layers of *chavara*. They were all dug through by a shaft, sunk from the surface of the rock to the bottom of the dromos, just in front of the stomion. From this shaft, which was filled with ordinary field earth and stones, the plunderers had entered the tomb chamber. This was filled with a heterogeneous mass of earth, composed of rock debris, clay, culture earth, and burial remains. The chamber had, apparently, been thoroughly worked through, and its archaeological value did not repay further excavation.

CHRONOLOGY

The potsherds of the dromos consisted of a majority of Black Slip II Ware mixed with Red Polished IV, White Painted IV, and some Red-on-Black Wares. No Late Cypriote sherds were found. Thus the tomb can be dated to the Middle Cypriote III period.

TOMB 12 (Fig. 130: 3—6)

	SIZE			
	Length	Width	Depth	Height
Dromos	4.16	1.21	2.53	—
Stomion	0.94	0.55	—	0.53
Chamber	3.94	4.24	—	c. 1.15

SHAPE

The dromos is a widening passage with almost perpendicular sides, and three irregular steps at the back end, leading down to an approximately horizontal area in front of the stomion. The entrance is arched, and the stomion is a gently sloping tunnel. It was closed by several stones, four of which were grinders. The chamber is roughly circular, with one niche in the back wall, and two short, deep recesses on the right side wall. The niches are all raised about 0.40 m. above the level of the floor. Between the two niches of the side wall, was a hole in the roof, leading to the surface of the rock. It seems likely that the hole was purposely cut, probably at a remote epoch, in order to plunder the tomb.

STRATIFICATION

The dromos was filled with three layers of finely pulverized *chavara*, and a bottom layer, harder compressed and coarser. In the middle of the dromos the two upper layers formed a concave curve, rising again above the stomion. The bottom layer decreased in thickness towards the entrance, and vanished entirely near the foot of the door-packing. It seems probable that this stratum represented the remainder of the original dromos-filling, which had been partly excavated in connection with secondary burials. The wavy stratification of the two upper layers has its special reason; for when the chamber of Tomb 14 was hollowed out, the cutters struck upon this dromos, the right side of which was pierced just at the point where the curved lines in the layers were observed. Evidently, some dromos-filling from Tomb 12 intruded into the chamber of Tomb 14, which circumstance caused the partial sinking of the remaining filling. The hole was closed by stones and pieces of rock piled up from the chamber of Tomb 14.

The chamber contained much extraneous earth, separated into the following layers, from the top:

- 1) A conical layer of brown field earth below the hole in the roof.
- 2) A layer of coarse rock debris, spread all over the chamber.

- 3) A thick layer of wet *chavara* emanating from the erosion of roof and walls, mixed with dark earth.
- 4) A layer of silted clay, principally found in the niche of the back wall.
- 5) A silted layer spread all over the chamber, consisting of burial remains, culture earth, rock debris, and clay.
- 6) A layer of dromos-filling found in the stomion.
- 7) A horizontally stratified layer of wet clay mixed with streaks of rock debris.
- 8) A layer similar to Layer 7, but of darker colour.
- 9) A fragmentary burial layer on the floor in the left section of the chamber.

Layer 9 represents, of course, the oldest burials in the tomb, together with the tomb-gifts Nos. 1—6, 8—28, 41, and 42, which all were found on the floor. The rest of the finds, except the mace-head No. 7 were found in or above Layer 5: the second burial stratum, which contained some scattered skeletal remains and finds Nos. 29, and 32—40. The two jugs Nos. 30 and 31 have, apparently, belonged to the same stratum, but have been slightly raised by the water: the heavy mace-head of stone (No. 7) has sunk down to the lower layer from its original position in the burial stratum.

It seems reasonable to suppose, that the hole in the roof was opened after the secondary burials of Layer 5 were carried out, which is the reason why the bones were scattered, the layer mixed with extraneous earth, and the tomb-gifts poor. After the sacking of the last burial stratum of the tomb, Layers 1—4 have gradually accumulated in the chamber.

BURIALS

Neither of the two burial layers contained skeletal material well enough preserved, to allow of any conclusions as regards the burial customs.

FINDS (GROUPS: PL. LXIII, 4—6; TYPES: L. OF PL. II)

1. Shallow bowl of Composite Ware (Red Slip and White Painted IV) with round base; raised rim, and loop-handle below rim. Red slip outside, and groups of short, wavy lines inside. Handle missing. Diam. 8.5. Floor.
2. Black Slip II depressed jug with round base; cylindrical, convex neck, and handle from rim to shoulder. Handle missing. Height 6.9. Floor.
3. White Painted IV shallow bowl with round base, and a string-hole projection at rim. A cross outside the bottom with the interstices filled with cross-hatchings; straight and wavy lines, radiating from a central circle inside the bottom. String-hole projection missing. Diam. 10.3. Floor.
4. Black Slip II globular jug with round base; cylindrical neck, and handle from neck to shoulder. Rim and handle missing. Height 11.5. Floor.
5. Red-on-Black shallow bowl with round base, and a horizontal handle on rim. Bands of parallel lines crossing the bottom at right angles, both within and without. Diam. 11.1. Floor.
6. Red-on-Black bowl, as No. 5, but with a double-horned, anthropomorphic projection below rim. Diam. 9.5. Floor.
7. Spherical mace-head of stone, pierced by a hole through the centre. Diam. 5.4. — 74.
8. Red Polished IV hemispherical bowl. Mottled surface. Diam. 10.2. Floor.
9. Two whetstones, pierced from top to side. Length 5.5; 5.2. Floor.
10. Bronze pin with thickening top; flattened head, and an eyelet in the middle of the pin. Broken into two pieces. Length 12.8. Floor.
11. Red Polished IV shallow bowl with round base. Diam. 10.5. Floor.
12. Black Slip II shallow bowl with round base, and a horizontal handle near the rim. Mottled surface. Diam. 10.5. Floor.
13. Black Slip II globular jug with tall, tapering neck; slightly splaying rim, and a raised handle from rim to shoulder. Mottled surface. Height 8.7. Floor.
14. Red Polished IV bowl with round base, and a horn-

- shaped string-hole projection below rim. Diam. 7.6. Floor.
15. Small, leaf-shaped, double-edged bronze knife with midrib; concave sides; rounded top, and two rivet-holes. Length 9.1. Floor.
 16. Thick bronze pin with a large button-head; end missing. Length 10.4. Floor.
 17. Black Slip II jug, as No. 13. Handle missing. Height 8.8. Floor.
 18. Red Polished IV shallow bowl with round base, and a string-hole projection below rim. Diam. 8.9. Floor.
 19. Red-on-Black globular jug with round base; cylindrical neck; a groove from rim to handle, and a curved handle from neck to body. Horizontal lines on shoulder, and vertical lines from neck to base. Parts of body missing. Height 18.9. Floor.
 20. Red Polished IV globular jug with round base; short, slightly concave neck, and somewhat splaying rim; handle from rim to shoulder. Handle missing. Height 7.5. Floor.
 21. Shallow bowl of Composite Ware (Black Slip and White Painted IV) with round base. Black slip outside, and an encircled, rectangular cross inside. Diam. 10.5. Floor.
 22. Red Polished IV bowl, as No. 18. String-hole projection missing. Diam. 10.4. Floor.
 23. Straight bronze pin with thickening top; end missing. Length 9.3. Floor.
 24. Red Polished IV shallow bowl with round base, and a horn-shaped string-hole projection at rim. Not complete. Diam. 9.6. Floor.
 25. Six circular beads of faience. Floor.
 26. Black Slip II bowl with round base, and a horizontal handle below rim. Diam. 16.8. Floor.
 27. Black Slip II oval amphora with base-knob; cylindrical neck, and two handles from neck to shoulder. Height 26.3. Floor.
 28. Bronze pin with thickening end, and an eyelet in the middle of the pin. Hooked. Length 13.0. Floor.
 29. Red-on-Black bowl, as No. 5. Diam. 9.5. — 28.
 30. Red-on-Black globular jug with flat base; wide, cylindrical neck; splaying rim, and handle from rim to shoulder. Thin lines around neck and belly, and vertical bands and lattice-lozenges on shoulder. Paint much worn. Height 20.7. — 11.
 31. Base-ring I globular jug with tapering neck, and handle from neck to shoulder. A wavy relief-line around shoulder, and a horizontal ridge around belly. Rim missing. Height 13.1. — 11.
 32. White Painted IV bowl, as No. 29. Diam. 8.0. — 28.
 33. Red-on-Black bowl, as No. 5, but with a double-horned handle. Diam. 8.6. — 35.
 34. Flat whetstone, pierced by a hole from top to side. Length 5.8. — 43.
 35. Straight bronze pin without head or eyelet. Length 10.8. — 43.
 36. Bronze knife, as No. 15. Length 9.2. — 60.
 37. Black Slip II shallow bowl with round base, and a horn-shaped string-hole projection at rim. Diam. 12.9. — 60.
 38. Straight bronze pin with thickening end. Length 10.6. — 60.
 39. Bronze tweezer with rounded top. Length 10.7. — 48.
 40. Straight bronze pin with thickening end. Broken into two pieces. Length 18.7. — 60.
 41. Black Slip II pear-shaped jug with round base; short, wide, cylindrical neck; splaying rim; a high handle from rim to shoulder, and a tubular spout opposite the handle. Spout chipped; paint worn. Height 17.2. Floor.
 42. 35 globular beads of white faience.

A summary of the Object Register, and the distribution of the finds between the two burial periods give the following diagram:

	Pottery							Bronze			Faience	Stone	
	R. P. IV	Bl. Sl. II	R.-on-Bl.	Wh. P. IV	R. Sl. + Wh. P. IV	Bl. Sl. + Wh. P. IV	Base-ring I	Knives	Tweezer	Pins	Beads	Whetstones	Mace-head
1st burial period	8. 11 14. 18 20. 22 24 -7	2. 4 12. 13 17, 26 27. 41 -8	5. 6 19	3 -1	1 -1	21 -1		15 -1		10. 15 16. 23 28 -5	25. 42 -2	9. 9 -2	
2nd burial period		37 -1	29. 30 33 -3	32 -1			31 -1	36. 38 -2	39 -1	35. 40 -2		34 -1	7 -1

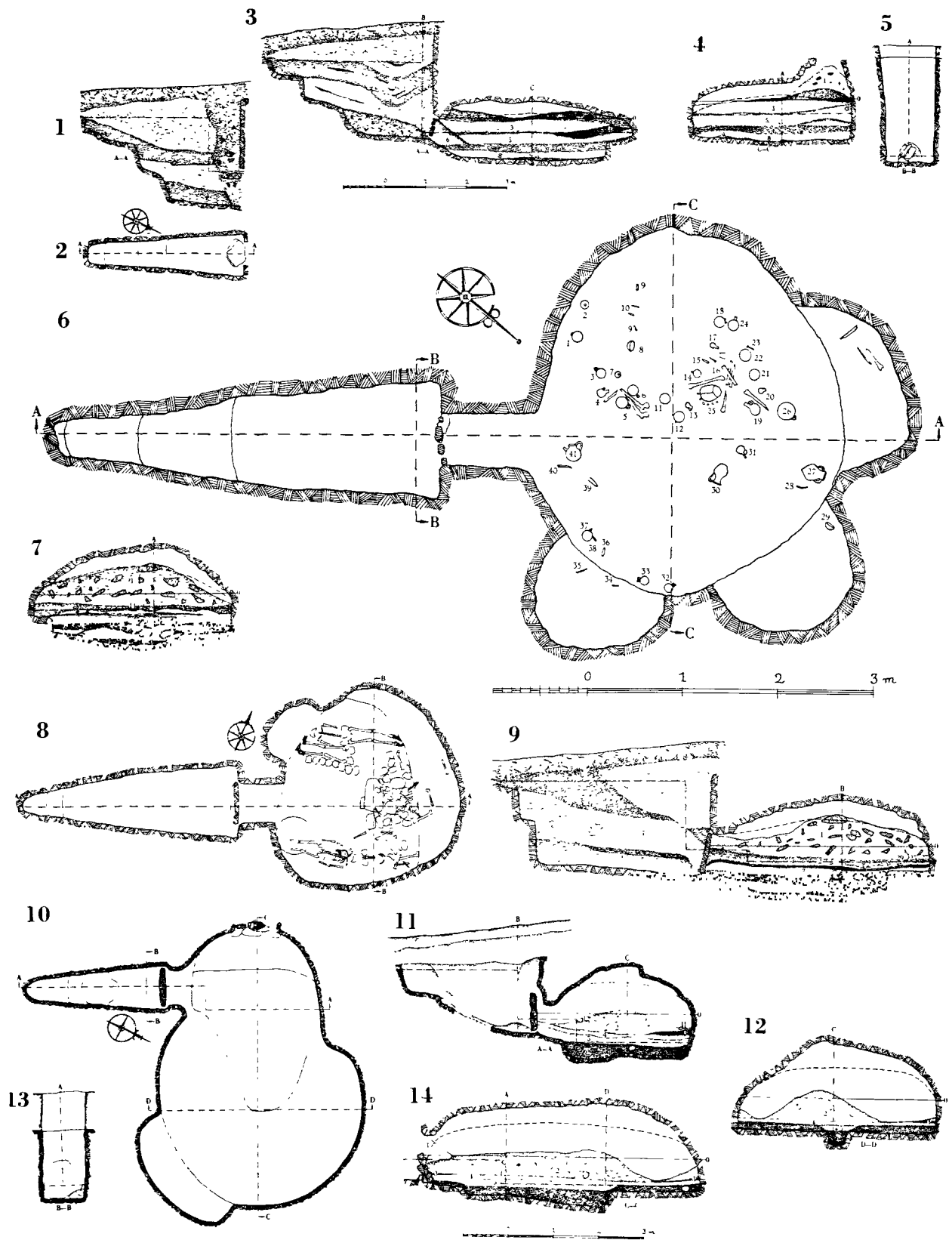

Fig. 130. Ajios Jakovos. Tomb 11, Section A-A (1); Plan (2). Tomb 12, Sections A-A, C-C, B-B (3, 4, 5); Plan (6). Tomb 13, Section B-B (7); Plan (8); Section A-A (9). Tomb 14, Plan (10); Sections A-A, D-D, B-B, C-C (11, 12, 13, 14).

CHRONOLOGY

The diagram demonstrates that the first burials must be dated to the middle of the Middle Cypriote III period. The second burial period is characterized by the absence of Red Polished and Black Slip Wares and the presence of a single vase of the Base-ring class, and therefore belongs to the beginning of Late Cypriote I.

TOMB 13 (Figs. 130: 8—9; 133: 1)

SIZE

	Length	Width	Depth	Height
Dromos	4.74	1.57	2.22	—
Stomion	0.87	0.81	—	0.84
Chamber	4.00	4.21	—	c. 1.65

SHAPE

The dromos is of the usual narrow corridor type, widening towards the front, with perpendicular sides, and two steps at the back end. The steps are very short and steep, which makes the horizontal area in front of the stomion very large. The doorway was closed by a slab of calcareous stone, wedged with some small chips at the upper edge. The tunnel-shaped stomion runs horizontally, and ends in a low step, leading down to the level of the chamber floor. The chamber is oval and provided with a shallow, raised niche along the whole back wall. In front of the niche the floor rises to a low ledge, which was later built out with roughly dressed stones, up to the level of the niche. Just to the left of the entrance is another small, semicircular niche raised about 0.30 m. above the floor. On the opposite side of the doorway is a cylindrical pit cut in the floor to a depth of about 0.20 m.

STRATIFICATION

The dromos was filled with *chavara*, stratified in four principal layers. The uppermost ran obliquely towards the top of the door stone and ended in a slightly darker section containing some gravel and sand. The three following layers were horizontally stratified and of uniform consistency. Above the bottom layer was a stratum of gravel and small chips of rock, compressed into a hard trodden floor. This finished just in front of the door-packing, where the bottom layer vanished. The stratification clearly indicates at least two separate burial periods, the later of which is marked by the floor stratum separating the two lower layers of the dromos-filling.

The chamber was filled, almost to the roof, with earth separated in the following layers:

- 1) A layer, about 1.00 m. thick, of *chavara* debris fallen from the roof.
- 2) A burial stratum resting on a floor of sand and gravel, and covered with a layer of brownish culture earth.

- 3) A horizontal layer of a wet mixture of clay and rock debris.
- 4) A layer containing brown culture earth, many potsherds, and some sand.
- 5) A removed burial layer in the centre of the chamber.
- 6) An intact stratum with burial remains resting on the floor.

The level of the niche in the back wall and of the stone ledge in front of it coincided with the upper edge of Layer 3. We have in this tomb to deal with two burial periods one represented by Layer 6, and the other one by Layer 2. To the older burial period belong all the finds on the floor, i. e., Nos. 33—36 and 38—40, together with pot No. 18, which was found in the burial earth, and No. 42 which lay on the floor of the back niche. The layer goes below the stone ledge which, therefore, must be of later date, and it seems probable that it was built when the tomb was made ready for new burials. On this occasion some of the later burials of the first epoch were removed. They were traceable in Layer 5, and the abundant potsherds in this layer and Layer 4 were the remains of their tomb-gifts. As Layers 3 and 4 run close to the stone ledge without foundation trench, they must have been placed in their present positions, contemporarily with the building of the bench: on top of them, the floor stratum of sand and gravel was spread.

The finds belonging to Layer 2 were Nos. 1—17, 19—32, 37, 41, and 43—44. Of these Nos. 1—3 were found in the stomion on a slightly higher level than the rest. They are, thus, the latest finds in the chamber.

BURIALS

In the bottom layer no skeletal remains were found. The places where the bodies had been deposited were covered with dark strata of mouldered, organic stuff. In the upper layer the latest burials were represented by three skeletons in outstretched, dorsal positions. Two of them were found to the left of the door, enclosed by a thin stone partition. One lay with the head, the other with the feet, towards the door. At the opposite side of the entrance, lay the third intact skeleton with its head towards the back wall of the chamber. On the stone ledge, behind the third skeleton and in the back niche, scattered remains of five other skeletons were found. Their original positions could not be ascertained.

FINDS (GROUP: PL. LXIV; TYPES: L. OF PL. II)

- | | |
|--|---|
| <ol style="list-style-type: none"> 1. Levanto-Helladic depressed, globular stirrup-vase with base-ring. Encircling lines around rim, neck, shoulder, belly, and base; red handles. Red, lustrous paint. Height 8.5. — 19. 2. White Slip II hemispherical bowl with bent rim, and a wish-bone handle below rim. Bands of ladder-pattern around rim, and from rim to base; short stripes and dotted lines in their interstices. Diam. 16.4. — 19. 3. Levanto-Helladic very squat stirrup-vase with base-ring, and almost horizontal shoulders. Encircling lines and handles, as No. 1, concentric circles on the knob, and dotted stars on shoulders. Height 7.9. — 21. 4. Levanto-Helladic squat pyxis with flat base; short, | <ol style="list-style-type: none"> concave neck; splaying rim, and three handles on shoulder. Encircling lines around rim, shoulder, and body. Diam. 10.0. — 35. 5. Levanto-Helladic globular jug with base-ring, concave neck, and two handles from neck to shoulder. Encircling lines around rim, neck, shoulder, belly, and base; parallel angular designs on shoulder. Lustrous paint. Surface worn; rim missing. Height 12.4. — 37. 6. White Slip II bowl, as No. 2. Horizontal lines around rim, and vertical lines from rim to base; lines on handle. Diam. 14.0. — 40. 7. Levanto-Helladic globular bottle with base-ring; narrow, concave neck; flaring rim, and two handles from neck |
|--|---|

- to shoulder. Vertical, concentric circles on both sides of body; encircling lines around rim, neck, and base; red handles, and bands of Z-shaped ornaments below handles. Red, lustrous paint. Height 14.4. — 36.
8. Small, biconical jug of *Bucchero Ware* with base-ring; concave neck, and arched handle from rim to shoulder. Fluted body. Height 6.8. — 31.
 9. Bull-shaped vase of *Base-ring Ware*, decorated with white stripes on body. Length 8.3. — 38.
 10. Plain cylinder of white *faience*. Length 2.2. — 40.
 11. Small, fluted, oblong bead of thin gold leaf. Diam. 0.7. — 40.
 12. Two small, cylindrical beads of gold with stilted ends. Length 1.2.
Cylindrical paste bead. Length 2.1. — 30.
 13. Plain White Wheel-made oval jug with flat base; concave neck; pinched mouth, and handle from rim to shoulder. Height 23.6. — 30.
 14. Plain White Wheel-made biconical crater with base-ring; flat rim, and two vertical handles on shoulder. Height 28.6. — 42.
 15. *Base-ring II* bowl with concave, angular outline; contracted, upright rim, and a hooked, horned, horizontal handle below rim. Diam. 17.7. Found in No. 14.
 16. White Slip II bowl, as No. 2. Diam. 18.0. — 40.
 17. White Shaved bobbin-shaped bottle with narrow base-ring; tapering neck; stilted rim, and handle from neck to shoulder. Height 18.7. — 48.
 18. Red Polished IV oval jug with round base; concave neck, and handle from rim to shoulder. Rim missing. Height 10.4. — 90.
 19. White Slip II bowl, as No. 2. Diam. 19.6. — 36.
 20. *Base-ring II* bowl, as No. 15. Diam. 17.8. — 38.
 21. White Slip II bowl, as No. 2. Diam. 19.0. — 38.
 22. Plain White Wheel-made oval jug with flat base; an impressed line below neck; cylindrical neck; pinched mouth, and handle from rim to shoulder. Height 18.5. — 38.
 23. Plain White Wheel-made flat bowl with base-ring, and raised rim. Diam. 14.8. — 32.
 24. *Base-ring II* bowl, as No. 15. Diam. 15.2. Found inside No. 25.
 25. Sherds of a Plain White Wheel-made crater, similar to No. 14. — 32.
 26. White Slip II bowl, as No. 2 but with two bands, and a chain-ornament around rim. Diam. 17.2. — 36.
 27. Plain White Wheel-made crater, as No. 14. Damaged. Height 24.2. — 30.
 28. Plain White Wheel-made oval crater with low foot; upright rim, and two indented, vertical handles on shoulder. Height 32.4. — 32.
 29. White Slip II bowl, as No. 2. Diam. 20.0. — 32.
 30. *Levanto-Helladic pyxis*, as No. 4, but with two handles. Encircling lines around rim, neck, shoulder, body, and base; a frieze of short, vertical stripes on shoulder; red handles. Paint worn. Diam. 7.5. — 39.
 31. Black Lustrous Wheel-made globular jug with flat base; tall, cylindrical neck; funnel-rim, and handle from neck to shoulder. Grey, polished, lustrous surface. Height 14.3. — 41.
 32. Bronze pin with thickening head. Length 9.3. — 38.
 33. White Painted IV shallow bowl with round base; bent rim, and a horizontal handle on rim. Bands of parallel, wavy lines crossing the bottom at right angles, both within and without; transverse lines on handle. Diam. 10.6. Floor.
 34. Red-on-Red globular jug with round base; concave neck; splaying mouth, and handle from neck to shoulder. Horizontal, wavy lines around neck and shoulder, and transverse lines on handle. Height 18.9. Floor.
 35. White Painted IV bowl with round base, and a horizontal, double-horned handle at rim. Decorated as No. 33. Diam. 8.7. Floor.
 36. Spherical mace-head of stone with a cylindrical hole through the centre. Diam. 5.9. Floor.
 37. White Slip II bowl, as No. 2. Decorated as No. 26. Handle missing. Diam. 17.4. — 48.
 38. White Painted IV globular jug with round base; short, wide, cylindrical neck, and a high, horned handle from rim to shoulder. Straight and wavy lines around neck; hatched triangles on shoulder, and a framed, wavy line around belly; transverse lines on handle. Height 12.5. Floor.
 39. Shallow bowl of *Composite Ware* (*Black Slip* and *White Painted IV*) with round base; bent rim, and horizontal handle on rim. Black slip outside; wavy lines crossing the bottom at right angles inside; shorter, wavy lines in their interstices. Diam. 10.9. Floor.
 40. Red-on-Black shallow bowl with round base; bent rim, and a horizontal loop-handle near the rim. Decorated as No. 33. Diam. 9.0. Floor.
 41. *Base-ring II* bowl, as No. 15. Diam. 15.2. — 35.
 42. White Painted V globular jug with round base; narrow neck; widening, pinched mouth, and handle from neck to shoulder. Encircling lines around neck and belly; groups of vertical lines from neck to belly, and from belly to base; a vertical line on handle. Piece of body missing. Height 14.2. — 51.
 43. Two spiral hair-rings of bronze. Diam. 2.6. 2.1. — 40.
 44. Bronze fragments, and a whetstone. — 40.

TOMB 14 (Fig. 130: 10—14; 132; 133: 2)

	SIZE			
	Length	Width	Depth	Height
Dromos	3.06	0.94	1.70	—
Stomion	0.53	0.73	—	0.70
Chamber	2.68	6.02	—	c. 1.50

SHAPE

The dromos is a narrow passage with vertical sides and a step at the further end. It widens gently towards the entrance of the chamber. Just below the step, is a large hole in the floor leading down to Tomb 10 A (cf. above p. 337). The door-packing consisted of a thick slab of irregular shape, kept in position by some smaller stones. The stomion is a slightly sloping tunnel, ending in an abrupt step, which leads down to the lowest part of the chamber floor.

The shape of the chamber depends to a great extent on the close neighbourhood of Tomb 12. The plan is not aligned along the longitudinal axis of the stomion, as there was no room in that direction. Immediately to the left of the entrance the above-mentioned collision with the dromos of Tomb 12 was shown by a large circular hole. In front, the chamber of the same tomb obstructed the cutters, and the only way out of the difficulty was to turn to the right, to complete the tomb: the chamber, thus, became very asymmetrical. To the left of the entrance a low ledge was carved out, and the floor was raised about 0.10 m. at a short distance from the entrance. The chamber bulges out to the right, and the lower floor-level covers only a small area in the neighbourhood of the entrance. The rest was cut out on a level about 0.40 m. higher. In the eastern corner is a shallow niche hollowed out of the wall, about 0.40 m. above the level of the surrounding floor.

The hole in the W. wall leading to the dromos of Tomb 12 was carelessly blocked by some stones and pieces of rock. Apparently it has afterwards been enlarged by the gradual erosion of the rock around its edges, as the stone-packing was confined to its lower central section.

STRATIFICATION

The dromos was filled with *chavara* consisting of one thick layer of loose consistency in the front section, a thin layer in the back section running down into the hole in the floor, and a harder compressed bottom stratum. Just above the door stone was a narrow, vertical stratum of slightly darker colour. The bottom stratum is interrupted above the hole in the floor. The significance of this stratification seems to be, in the first place, that the dromos has once been partly excavated in connection with some secondary burial. This is indicated by the extent and consistency of the thick layer in the front part of the dromos. The bottom layer is, apparently, a remainder of the original dromos-filling. It seems likely that the communication between Tomb 10 A and this dromos was brought about when the dromos was partially excavated during the preparations for the secondary burials. At



Fig. 131. Ajios Jakovos. Tomb 6. Interior view with finds *in situ*.



Fig. 132. Ajios Jakovos. Tomb 14. Interior view with skeletons *in situ*.

that time the damage was repaired in haste, with some perishable material, probably wooden planks. Before the dromos was refilled the Chamber A of Tomb 10 was entered, and its upper burial layer sacked, and it must, therefore, be of older date than the latest burials in this tomb.

The dark vertical layer above the stomion was probably caused by rain-water which has found its way below the surface into the dromos.

In the chamber the following stratification was observed: —

- 1) A fan-shaped layer of dromos earth, which had poured in from the dromos of Tomb 12 (cf. above p. 341), found close to the hole in the W. wall.
- 2) A thick layer of debris from roof and walls, covering the whole chamber.
- 3) A burial layer in the N. W. section of the chamber opposite to, and to the left of the entrance. It was also found W. of the niche, and at the opposite side of the chamber.
- 4) A floor stratum of sand and gravel spread over the whole chamber.
- 5) A horizontal layer of clay and sand.
- 6) A burial layer of unusual thickness covering the floor of the whole chamber and the niche.

The Layers 3 and 6, evidently, represent two burial periods. They were separated by the artificial filling strata (Layers 4—5) when the tomb was prepared for the secondary burial (Layer 3). An analysis of the earlier burial stratum shows that it contains twenty-five more or less well-preserved burials. Mouldered remains of about ten other bodies were found. To these belong the finds Nos. 5—10, 16—22, 24—44, 48, 49, and 52—57. To the second burial period belong five skeletons and the objects Nos. 1—4, 11—15, 23, 45—47, 50, and 51. It can be observed by studying the levels of the finds given in the Object Register, that Nos. 20, 21, and 22 are found in Layer 4, brought into the chamber

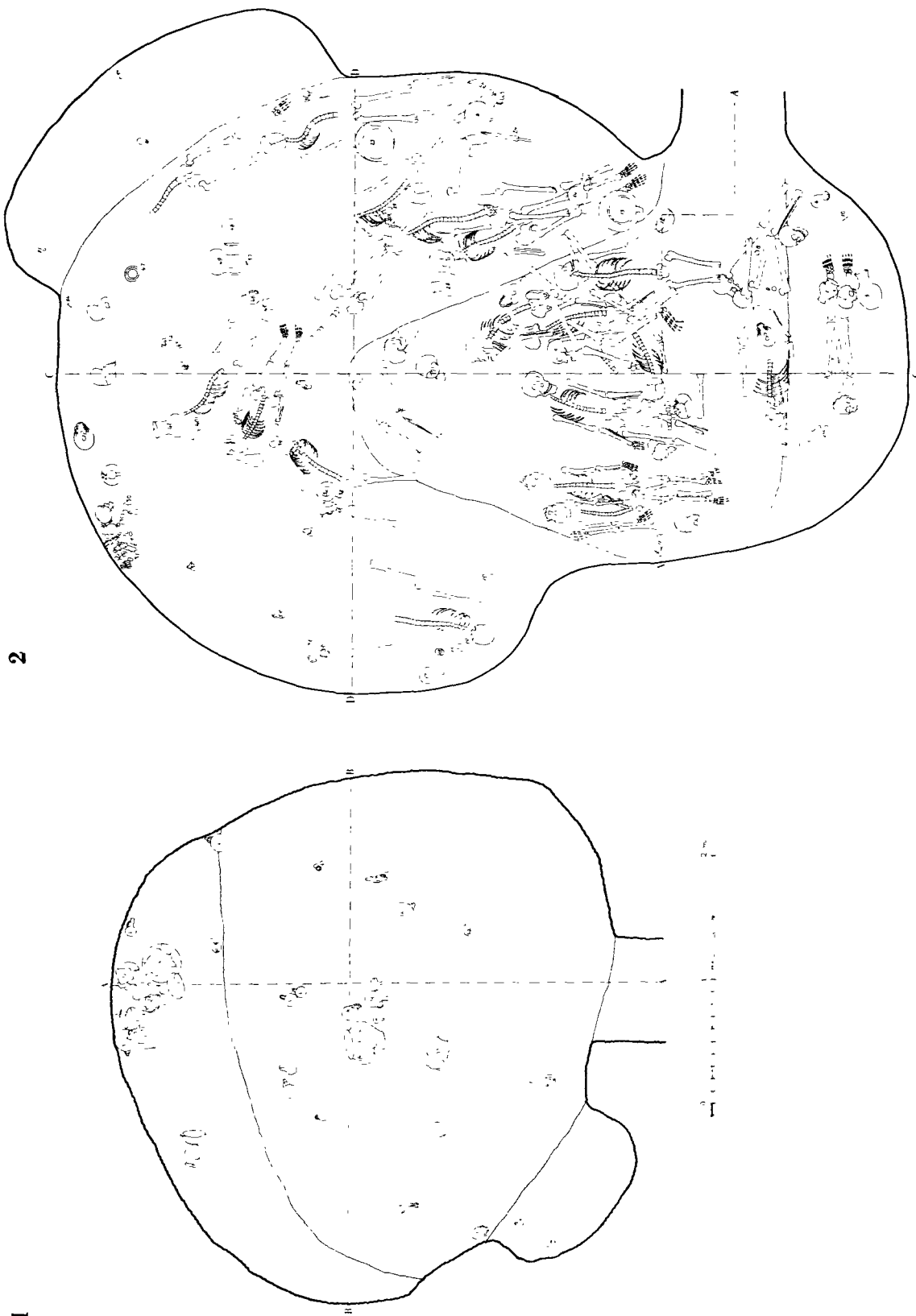

Fig. 133. Ajiros Jakovos. Tomb 13, Finds *in situ* (1). Tomb 14, Finds *in situ* (2).

during the preparations for the secondary burials. To this difference in level no great attention should be paid, as it is a matter of course that some of the vases might easily have been moved slightly during these preparations. The finds in question have, therefore, to be assigned to the first group.

BURIALS

The mass-burial of about thirty-five bodies is the principal feature of the first burial period. The skeletons were mainly found in outstretched, dorsal, or slightly lateral positions, often piled on top of each other. The detailed plan (Fig. 133: 2) speaks for itself and a description of all the bodies does not seem necessary.

To the upper layer belong five skeletons all in dorsal, outstretched positions. They were found, one in each part of the chamber. Thus one was lying in the E. niche, one near the back wall opposite the entrance, one on the raised section of the chamber, approximately in the transverse axis, one to the W. of the E. niche along the wall, and, finally one opposite the same niche.

FINDS (GROUPS: PL. LXV; TYPES: L. OF PL. II)

1. Levanto-Helladic piriform amphora with wide, concave neck; splaying rim; base-ring, and three horizontal handles on shoulder. Encircling lines around neck, shoulder, belly, and base; red handles, rim, and base; a frieze of chevron-shaped meander-elements between the handles. Lustrous paint. Height 16.4. — 31.
2. White Shaved bobbin-shaped bottle with small base-ring; concave neck; stilted rim, and handle from neck to shoulder. Height 22.6. — 30.
3. White Slip II hemispherical bowl with an angular, horizontal handle below rim. A framed, wavy line, and dots around rim; groups of vertical lines from rim to base; lines on handle. Diam. 16.0. — 30.
4. White Slip II hemispherical bowl with somewhat bent rim, and a triangular wish-bone handle below rim. A ladder-pattern frieze around rim; ladder-pattern stripes from rim to bottom, and smaller, similar designs and dotted lines in their interstices. Transverse lines on handle. Diam. 20.0. — 30.
5. Red-on-Black globular jug with flat base; wide, cylindrical neck; splaying rim, and handle from rim to shoulder. Horizontal lines around neck and belly, and bundles of vertical lines from neck to base. Height 26.0. — 48.
6. Red-on-Black globular jug with round base; narrow, somewhat concave neck; splaying rim, and handle from rim to shoulder. Decorated as No. 5. Height 13.8. — 57.
7. Leaf-shaped, double-edged bronze knife with midrib; tapering top; flat tang, and three rivets. Length 17.2. — 62.
8. Plain, circular bronze ring with overlapping ends. Broken into three pieces. Diam. 4.6. — 72.
9. Bronze ring, as No. 8. Broken into two pieces. Diam. 4.2. — 76.
10. Fragment of a thin bronze needle. Length 5.7. — 52.
11. Base-ring I globular jug with tall, tapering neck; funnel-rim, and handle from neck to shoulder. Height 15.2. — 32.
12. White Slip II bowl, as No. 4. Handle missing. Diam. 18.0. — 19.
13. Plain White Hand-made squat crater with base-ring; flat, stilted rim, and two vertical handles on the shoulder. Height 22.0. — 30.
14. Red-on-Black globular jug with round base; tall, narrow, concave neck; splaying rim, and handle from rim to shoulder. Decorated as No. 5. Height 23.0. — 27.
15. White Shaved bobbin-shaped bottle with pointed base, cylindrical neck; slightly pinched mouth, and handle from rim to shoulder. Height 14.0. — 40.
16. Base-ring I globular jug with tall, tapering neck; funnel-rim, and handle from neck to shoulder. Two ridges around neck, and vertical relief-lines on body. Height 14.0. Niche floor.
17. Red-on-Black jug, as No. 6; paint much worn. Height 19.5. Niche floor.
18. Oblong mace-head of stone with a cylindrical hole through the centre. Length 5.9. Niche floor.
19. White Painted V small, oval jug with flat base; wide, convex neck, and handle from rim to shoulder. Surface worn, paint almost obliterated; neck and handle missing. Height 6.5. Niche floor.
20. White Painted V globular jug with flattened base; cylindrical neck; slightly raised handle from rim to shoulder, and a tubular spout opposite the handle. Encircling lines around rim and neck; vertical, broad lines from neck to base; lines on spout and handle, and thin, vertical, wavy lines on neck. Height 9.0. — 44.
21. Base-ring I jug, as No. 11. Base-ring chipped. Height 11.0. — 50.

22. Red-on-Black jug, as No. 14; the vertical bands are composed of short, horizontal lines. Height 23.0. — 45.
23. Plain White Hand-made crater, as No. 13, but with handles from rim to shoulder. Height 19.0. — 40.
24. Narrow, double-edged bronze sword with high midrib, and long, solid, hooked tang. Tang broken. Length 39.3. — 52.
25. Red-on-Black jug, as No. 6. Height 15.0. — 57.
26. White Slip I hemispherical bowl with a wish-bone handle below rim. A wavy line around rim; a framed, dotted line below rim, and vertical lines, ladder-pattern stripes, and dotted bands from rim to base. Diam. 20.0. — 55.
27. Circular bronze bracelet. Diam. 9.9. — 53.
28. Black Slip III globular jug with flat base; cylindrical neck; somewhat pinched mouth, and handle from rim to shoulder. Rim pierced below the handle. Paint worn; rim chipped; handle missing. Height 20.0. — 66.
29. Red-on-Black pear-shaped jug with round base; cylindrical neck; splaying rim, and handle from rim to shoulder. Paint obliterated. Height 7.5. — 56.
30. Bull-shaped vase of Base-ring Ware, painted with white stripes on grey-red ground. Right hind leg missing. Length 12.0. Layer 6.
31. Rough terracotta idol of probably female sex. The hands are holding the breasts; the face is only indicated, not properly modelled. No paint. The idol was surrounded by beads of faience of various types, and of shells. Length 10.7. — 55.
32. Plain White Wheel-made flat bowl with high base-ring, and raised, splaying rim. Rim chipped; handle missing. Diam. 14.0. Layer 6.
33. Bull-shaped vase of Base-ring Ware, painted with white stripes on grey ground. Height 12.5. Layer 6.
34. Black Slip II much damaged miniature jug. Height 7.0. Layer 6.
35. Black Slip II pear-shaped jug with concave neck, and handle from rim to shoulder. Body much damaged. Height 8.5. Layer 6.
36. Red-on-Black globular jug with flat bottom; distinct shoulder; concave neck; pinched mouth, and handle from rim to shoulder. Horizontal stripes around neck, and vertical lines on shoulder. Height 10.0. Layer 6.
37. Red-on-Black jug, as No. 36. Neck and handle missing. Height 12.0. Layer 6.
38. Fragments of two thin bronze needles. Layer 6.
39. Black Slip III globular jug with tall, tapering neck; funnel-rim; flat base, and handle from neck to shoulder. Handle missing. Lustrous surface. Height 8.5. Layer 6.
40. Red-on-Black jug, as No. 6. Height 15.0. Layer 6.
41. Red-on-Black globular jug with round base; wide, concave neck; splaying rim, and a knobbed handle from rim to shoulder. Horizontal lines around neck and belly; a wavy line around neck, and horizontal lines on shoulder. Paint worn. Height 22.0. Layer 6.
42. Leaf-shaped, double-edged spear-head of bronze with midrib; convex sides, and a tubular socket widening backwards with a groove at edge. Length 21.0. Layer 6.
43. Leaf-shaped, double-edged bronze knife with midrib; straight sides; tapering, flat tang, and three rivets. Length 19.6. Layer 6.
44. Base-ring I jug, as No. 16. A wavy relief-line on shoulder, and two ridges around neck. Height 13.0. Layer 6.
45. Bull-shaped vase of Base-ring Ware, as No. 33. Length 15.0. — 40.
46. Levanto-Helladic depressed, globular jug with base-ring; concave neck; splaying rim, and handle from rim to shoulder. Encircling lines around rim, neck, shoulder, body, and base. Lustrous paint. Height 9.5. — 40.
47. Levanto-Helladic squat pyxis with cylindrical body; flattened base; conical shoulders; short, concave neck; stilted rim, and two horizontal handles on shoulder. Encircling lines around rim, neck, shoulder, body, and base; a frieze of vertical staff-ornaments on shoulder. Lustrous paint; much worn. Diam. 11.5. — 42.
48. White Painted V squat jug with flat base; wide neck; splaying rim, and handle from rim to shoulder. Neck and shoulder covered with a chess-board pattern of hatched and plain squares; two ladder-pattern zigzag friezes, separated by bands of hatched and plain squares, below belly; a thick, wavy line on handle. Pieces of body and neck missing. Height 18.0. Layer 6.
49. Red-on-Black jug, as No. 41. Damaged. Height 27.0. Layer 6.
50. Two thin bronze needles; not complete. Length 7.3; 5.3. — 38.
51. Levanto-Helladic pyxis, as No. 47, but with mat paint. One handle missing. Diam. 8.0. — 35.
52. Base-ring I jug, as No. 16. Vertical relief-lines on body. Height 15.0. Layer 6.
53. Red-on-Black pear-shaped jug with round base, and handle from rim to shoulder; part of neck missing. Paint obliterated. Height 8.3. Layer 6.
54. Bronze tweezer with loop-shaped top. Length 9.3. Layer 6.
55. Circular earring of bronze with overlapping ends. Diam. 2.0. Niche.
56. Circular ring of bronze with overlapping ends. Diam. 4.4. Niche.
57. Fragment of a bronze ring. Diam. 2.6. Niche.

M. C. III A.	5; 6 ^I	Total: 2 burial groups
M. C. III B.	1; 4 A; 4 B; 6 ^{II} ; 11; 12 ^I ; 13 ^I	» 7 burial groups
M. C. III C.	2; 3; 7; 8 ^I ; 9	» 5 burial groups
L. C. I A.	8 ^{II} ; 10 A; 10 B; 12 ^{II} ; 14 ^I	» 5 burial groups
L. C. I B.		
L. C. II A.	8 ^{III} ; 13 ^{II} ; 14 ^{II}	» 3 burial groups
L. C. II B.		
L. C. II C.		

The diagram shows clearly what has been pointed out above: there is a gap in the use of the burial ground after L. C. I A, the time of the mass-burials. Further, the burial ground definitely stopped being used after the L. C. II A period.

All the tombs, with the exception of Nos. 10 and 14, were constructed during the Middle Cypriote III period, and they have also many essential features common. The stepped corridor-shaped dromos is a rule, and the flat, vaulted chamber of more or less irregular shape is met with in most cases. Tombs 4 and 10 have two chambers, apparently an indication of the persistence of the tradition of the Early Bronze Age. The orientation of the tombs according to the cardinal points seems to be rather arbitrary.

Inhumation was the only type of burial, and coffins were not used. A squatting position of the bodies is met with only in pure M. C. III interments, but is not even there a rule without exceptions. The outstretched, dorsal position is characteristic to L. C. II, and L. C. I displays a more varied system, as can be expected during a period of mass-burials.

A comparison between the diagram and the field-map shows that the tombs containing interments of Late Cypriote date are found only in the N. E. section. The earlier tombs are found mainly at the opposite end.

The Cult places at Dhima

During the first excavation at Ajios Jakovos when the necropolis of Melia was investigated, we were in constant search for the settlement to which the tombs had once belonged, as it was our intention to make some stratigraphical tests which would corroborate the chronology of the tombs. One of the villagers of Mandres drew our attention to a field where his wooden plough had turned up much broken pottery, and a superficial investigation showed that the sherds of the surface layer belonged to approximately the same epoch as the latest burials in the tomb-field of Melia. A trial excavation was, therefore, decided upon the locality where these finds were made. It is situated not far from the northern outskirts of the village of Ajios Jakovos, on the road leading up to Mandres (Fig. 118). A small rill, watering the gardens of the village has formed a narrow valley between steep hills which, here and there, are covered by bushes and low, crooked pine-trees. The valley

widens towards the village, and the ground forms a series of low hills, which are called Dhima.

On top of one of these hills close to the village, the sherds of the Bronze Age were found and the first excavation carried out. We were disappointed in our expectations of finding a stratified settlement on this place, but the result of the excavation is rendered below under the heading: The Bronze Age Sanctuary. A month later — in September 1929 — another of the hills was investigated, some hundred metres to the north of the first. On the surface were certain traces indicating a cult place of the Iron Age, and an excavation was carried out under the leadership of Mr. A. Westholm. In the following description it is called The Iron Age Sanctuary.

I

THE BRONZE AGE SANCTUARY

(Plan XIII; Figs. 134—137)

DESCRIPTION

The excavation was started by digging a trench in an approximately east and west direction, crossing the top-plateau of the hill. The earth covering the virgin soil, a loose, sandy, sedimentary rock, was very scanty, and its depth varied from 0.25 to 0.80 m. Architectural remains were almost absent, and the boundaries of the excavation were only determined by the extent of a floor layer, lying partly on the rock, partly on top of a levelling stratum of sandy earth. The floor was covered by a culture stratum, which contained fragments of pottery and a deposit of beautiful finds. The simple stratification of the site can be studied in the sections (Plan XIII, 2). The extent of the floor could be fixed by systematic trenching and transverse trenching, and by excavating the area in small squares.

The floor turned out to be a roughly circular area with a maximum diameter of 10.10 m. Running in a north and south direction, about 1.50 m. to the west of the centre, lies a low wall of very poor construction, founded on the rock. It does not reach from edge to edge, but divides the floor into two unequal halves, the E. one of which lies about 0.25 m. lower. In this lower part of the area are two circular stone podia founded on the rock. The floor runs up against the wall and the podia. The northern of the two podia measures 2.62 m. in diameter, the southern only 1.12 m. Both reach a total height of 0.95 m. and stand 0.45 m. above the floor. Below the floor to the S. of the two podia is a circular rock-cut pit, which was filled with ash and potsherds, covered by a layer of rough stones. As the floor lay unbroken on top of the pit, the latter must be a remnant from earlier times.

The centre of the western section of the area was occupied by a large bath-shaped basin of terracotta placed in a shallow pit in the rock. Its edges rose 0.33 m. above the floor. The exterior dimensions of the basin are 1.28. 0.63 / 0.47, and the average thickness of

the ware is 0.05 m. On one side of the basin is a small rock-cut pit of trapezoid shape, and on the other is a small cylindrical pit. In this area, and especially in and around the terracotta basin all the finds were made. They lay on, or immediately above the floor.

FINDS (GROUPS: PLS. LXVI; LXVII; TYPES: L. OF PL. II)

1. Plain, circular silver bracelet with tapered, overlapping ends. Diam. 6.3.
2. Horseshoe-shaped gold finger-ring with a thick rectangular bezel, engraved with the cartouche of Thotmes III, flanked by two beetles. Diam. 2.4.
- 3+4+27. A gold necklace composed of seven hollow beads in the shape of pomegranates, and six large and two small, hollow beads in the shape of dates. In the centre, is a large Babylonian cylinder of shiny haematite with solid gold mountings. The representation on the cylinder runs as follows: — A group of two persons dressed in long gowns; horned, pointed helmets, and tip-tilted shoes, facing each other. They carry goats in their arms; between them stands a lion on its hind legs, and above the heads of the goats is a star. Behind the person on the left stands a miniature male figure, apparently naked. To the right of the group stands a single figure in similar dress also carrying an animal in his arms; his left arm is raised and holds a dagger. To the right of this figure are other two men similar to the first. Between them is a lion standing on his hind legs. Length of necklace 19.8. Length of cylinder 3.7.
5. A pair of large crescent-shaped earrings of twisted and plaited gold wire. Diam. 4.7.
6. A pair of spiral hair-rings of solid gold. Diam. 3.3.
7. A pair of hair-rings of gold, as No. 6. Diam. 1.9.
8. Finger-ring of gold with a circular bezel; the inside of the ring is plain, the outside consists of alternating plain and twisted gold wires. In the centre of the bezel, there has probably been either a stone or a piece of glass-paste. Diam. 2.0.
9. A pair of circular earrings of solid gold with overlapping ends. Diam. 3.5.
10. A pair of gold hair-rings, as No. 6. Diam. 3.4.
11. Gold finger-ring as No. 8. Diam. 2.0.
12. Babylonian cylinder of shiny haematite with solid gold mountings. On the cylinder are engraved four figures, arranged in two groups. In the first group stands an, apparently, female figure with her left hand raised and holding a knife, and her right bent at the elbow in a gesture of adoration. In front of her stands a lion-headed figure in a similar pose; they are both dressed in long gowns and tip-tilted shoes. Between them stands a naked male figure of miniature size, with his hands crossed on his breast. His face is in right profile. The second group consists of two persons, one of which holds a spear over his right shoulder, and a lion in his left hand. The other is winged, and wears a cap with two horns. He carries a goat in his arms, and touches with his right hand the lion which hangs from the left hand of the first figure. Behind the winged figure stands a prancing goat on his hind legs; between the two groups runs an inscription of cuneiform letters. The inscription is published by Dr. W. Riedel in the Appendix. Length 3.5.
13. Triangular axe of dark, shiny stone with straight, sharp edge. Length 4.7.
14. Oval bone plaque, pierced by three holes; not complete. Length 9.0.
15. Several fragments of plain gold leaf.
16. Fragment of a small silver funnel. Length 2.3.
17. Several fragments including a bronze chain, a piece of a bronze tweezer, and some lumps of iron.
18. Large White Slip I crater with flat base; wide, concave neck; stilted rim, and a wish-bone handle on shoulder. A wavy line on rim; groups of vertical lines inside rim; dotted, vertical lines on neck; a chain of hooked loops, framed by horizontal bands of ladder-pattern around belly; vertical, dotted lines, alternating with bands of ladder-pattern from belly to base; bands of oblique lines on handle. Height 24.3.
19. Levanto-Helladic pear-shaped amphora with narrow base; concave neck; flattened rim, and three horizontal handles on shoulder. Paint obliterated. Height 12.0.
20. A fragment of plain gold leaf.
21. Flat arrow-head of bronze with barbs and rounded top; the tang is straight and solid, and provided with profiled ridges. Length 6.7.
22. Leaf-shaped arrow-head of bronze with low midrib; pointed end, and straight, solid tang. Length 9.0.
23. Circular silver ring with a small mounting of gold. Diam. 2.8.
24. Six small silver funnels with gold mountings; three are not complete. Length 2.6.
25. Silver funnel, as No. 24. Not complete. Length 2.6.
26. Two silver funnels, as No. 24. Length 2.8.
27. Two date-shaped golden beads of small size (see No. 3).
28. Cylinder of shiny haematite. The centre of the representation is a winged Janus-faced figure dressed in long gown, and surrounded by a goat on her left side and a winged quadruped on her right side. The latter is turned upside down. To the right of the goat is a conventionalized palm tree growing up from the forehead of a bucranium. Length 1.9.
29. Biconical Base-ring II jug with cylindrical neck; flat rim, and handle from neck to shoulder; at top and base of handle are button-ornaments in relief; handle decorated with an incised, hatched band. Pieces of body missing. Height 14.3.
30. Levanto-Helladic squat jug with base-ring; concave, widening neck; plain rim, and handle from rim to



Fig. 134. Ajos Jakovos. Bronze Age Sanctuary.
View from S. E.



Fig. 135. Ajos Jakovos. Bronze Age Sanctuary.
Fragments of incense-burners *in situ*.

ANALYSIS AND CHRONOLOGY

There can be no doubt that the excavated area was once a cult place. The type of architecture, the rich finds, and above all the presence of the incense-burners, give satisfactory evidence in that respect. The state of preservation of the immovable remains was very poor, and does not permit any definite conclusions as regards the original arrangement of the sanctuary; and it is only a matter of good luck that so many of the votive offerings — most of which were found immediately below the surface of the soil — had escaped attention, especially as the immediate neighbourhood had been inhabited in Classical, Roman and Byzantine times, judging from the abundant remains of these epochs found on the ground around the sanctuary.

The sacred area has probably been fenced-in in some way, but of the enclosure not the slightest traces were found: it must have been of some perishable material. The sanctuary was divided into two parts by a wall, the low foundations of which have been described above. The two apartments communicated with each other by a door situated between the S. edge of the floor and the S. end of the dividing wall. The main entrance seems to have been from N. W. The S. and W. sides of the temenos are bound by the steep slopes of the hill, and the E. and N. sides are, more or less, blocked by the two circular podia of stones. Therefore, the N. W. side is the only convenient place for an entrance. This being so, the worshipper first entered the exterior court in the centre of which the large terracotta basin was placed. The main accumulation of votive gifts was found in and around this basin, but a small heap of pottery lay in Square D 1 just at the edge of the floor, apparently *in situ* (see Plan XIII, 1; Fig. 135).

Behind the wall on a slightly lower level lay the interior temenos, dominated by the two round podia which must be interpreted as altars. There were no ash or other traces of offerings, but the lack of these accessories is satisfactorily explained by the fact, that the



Fig. 136. Ajios Jakovos. Bronze Age Sanctuary.
The sacrificial basin during excavation.



Fig. 137. Ajios Jakovos. Bronze Age Sanctuary.
Votive offerings surrounding the sacrificial basin.

altars were only covered by a very thin layer of earth, which was entirely turned up by the plough. It is worth mentioning, that not a single votive gift was found in this apartment.

The chronology of the site is, in all essential parts, clear. A *terminus post quem* for the excavated floor and the finds is obtained by an examination of the potsherds found in the rock-cut pit below the floor of the inner temenos. This pit was surely the bothros of an older sanctuary situated on the same place, and the sherds found in it are fragments of earlier votive offerings. The same type of bothros is frequently found in the Late Cypriote sanctuary of Idalion (cf. Vol. II). Its presence here proves that the site was a cult place, even before the epoch represented by the excavated temenos and its contents. The fragments found in the pit are the following: —

Plain White Hand-made Ware	110	Red-on-Black Ware	50
Red Polished IV Ware	3	Red-on-Red Ware	4
Black Slip II Ware	96	White Painted V Ware	1
Red Slip Ware	27	Light-on-Dark Ware	9

This material dates the pit to M. C. III. The nine sherds of the unusual Light-on-Dark Ware are especially worth mentioning; they were found also in the neighbouring necropolis at Melia (Dromos of Tomb 3, and Chamber of Tomb 9) and in Tumulus 7 at Paleoskoutella (cf. below p. 429). This ware indicates a late stage of the period.

All the finds on, and immediately above the floor are dateable to the Late Cypriote II

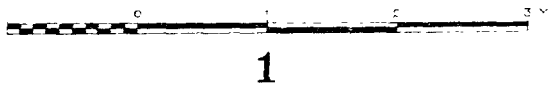
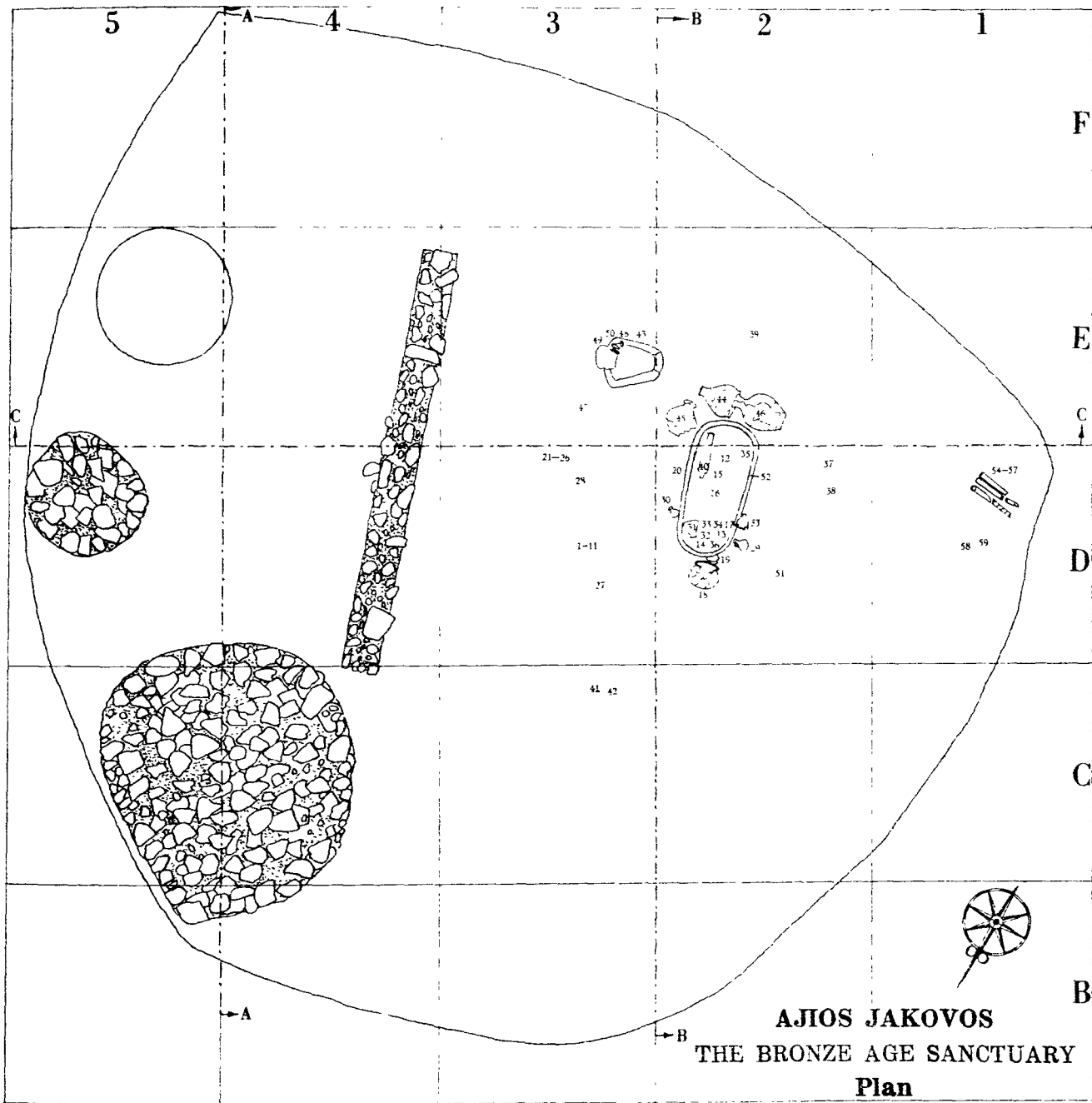

Sections

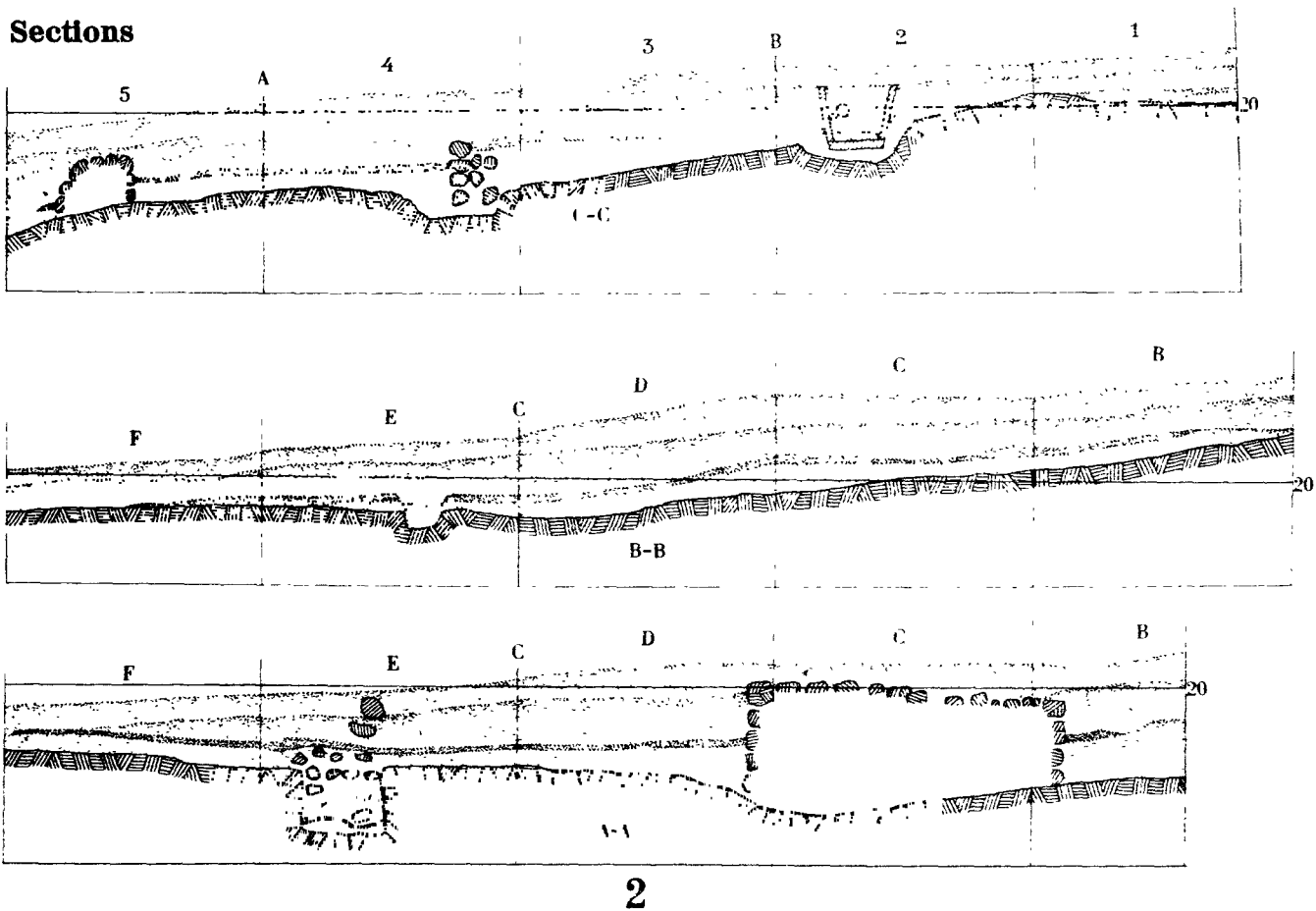

period and to a rather early stage of this epoch. The finger-rings Nos. 8 and 11 are of identical shape with the ring found in Enkomi Tomb 3, No. 130, and the date-shaped beads of our necklace No. 3+4--27 occur frequently in the composite necklace of the same tomb in Enkomi. A valuable *terminus post quem* for the most prosperous period of the sanctuary is also provided by the engraved ring No. 2 with the cartouche of Thotmes III, and the shape of the ring, moreover, corresponds closely to that of No. 46 in Tomb 3 of Enkomi. The evidence yielded by the pottery is in full accordance with this dating. Both the Cypriote, the Red Lustrous Wheel-made and the Levanto-Helladic Wares agree with a dating of the sanctuary to the 14th century B. C.

It is worth mentioning that none of the finds are safely dated to Late Cypriote I. This is peculiar as the bothros in the inner temenos shows that the sanctuary already existed in the Middle Cypriote III period. If it had been in uninterrupted use, either a Late Cypriote I bothros, or finds datable to this period among the votive gifts would have been found. At present, it is enough to state that, as far as our evidence goes, it seems inevitable to presume a gap in the continuous use of the cult place during the Late Cypriote I period, the same period that was introduced by the mass-burials in the necropolis of Melia.

II

THE IRON AGE SANCTUARY

(Plan XIV; Figs. 138—141)

ARCHITECTURAL DESCRIPTION

The small field where the second excavation at Ajios Jakovos was carried out lies on a low hill, close to the road leading up to the village of Mandres (Fig. 138). It is bounded on two sides by two small rills, which only contain water during the winter. The area was said to have yielded occasional finds of terracotta statuettes, and rumour maintained that a large, bearded statue of limestone had been found in the same field.

A trench was dug through the area in an approximately east and west direction. In the trench appeared the foundations of a house; and this and the region around it were laid bare. The excavation was carried out according to the usual system applied in the open field, i. e., the place was dug in squares with sides of 2 m., aligned at right angles to the trench. Thus, careful observations of the stratification of the site were made possible.

The house is a rectangular building facing North and South. It measures 6.95×10.75 m. Its N. short side is situated just at the edge of the low hill and is badly preserved. There is no boundary wall left. The long walls and the S. end-wall are built of rubble of local limestone, bound with much lime-cement. In the walls the jars Nos. 17 and 66—70 were embedded. The walls, founded on under-lying layers of debris, containing enormous quantities of potsherds, are about 0.80 m. high, and lined with a layer of lime-cement 0.03 m. thick. The same cement continues without a break over a small moulding at the base of the wall, and covers the whole floor of the building: it is supported by a compact layer



Fig. 138. Ajos Jakovos. Iron Age Sanctuary.
View from the North.

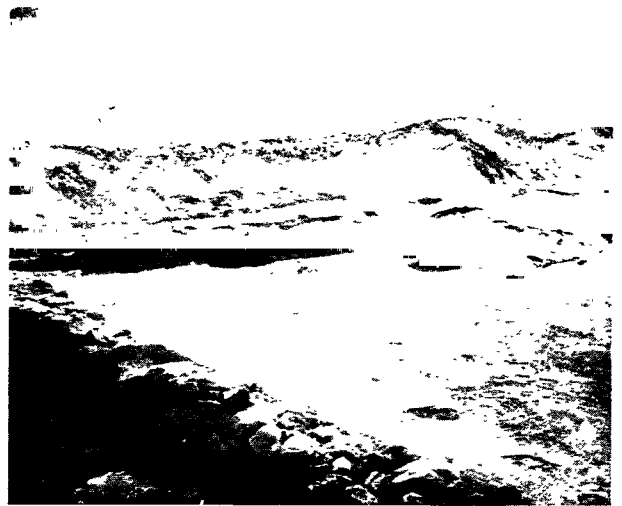

Fig. 139. Ajos Jakovos. Iron Age Sanctuary.
Interior view.

of rubble. This floor is hence called the second cement floor (Level 79.3), as it rests directly on top of another floor of exactly the same construction, called the first cement floor (Level 77.8), which runs up against the walls and on the same level as their base.

The house is divided into two rooms by a transverse wall, built approximately at right angles to the long W. wall, on which it abuts. The two rooms, the inner of which is the smaller, communicate with each other by means of a wide door between the E. end of the transverse wall and the long E. wall. The transverse wall is founded on top of the second cement floor. Near the W. wall of the inner room stands a small, square podium founded on the second cement floor and built against the cement revetment of the wall. It consists of fairly regular stones bedded in lime-cement, and is covered by a thin revetment of the same cement.

In the two sections through the house, another layer of stones of slightly larger size than those used for substructure of the two cement floors can be seen. This was, apparently, the foundation of a third floor which has completely disappeared, as it lay very close to the surface of the soil. Even the foundations are destroyed by the plough at the E. edge of the area.

At a distance of 0.70—0.80 m. from the long W. wall of the house runs a detached wall. It is roughly parallel with the longitudinal axis of the building and reaches a maximum height of 1.05 m. This measurement is only valid for the central part of the wall, which is founded on the same level as the W. long wall of the house. The rest of the wall is only approx. 0.50 m. in height. This is due to its being founded on a level about 0.55 m. higher. As no foundation trench was observed, it is apparent that the wall consists of an older central section, and that its extremities are newer. The central part is of a more solid construction than the wings, which consist practically of only two rows of stones piled on top of each other.

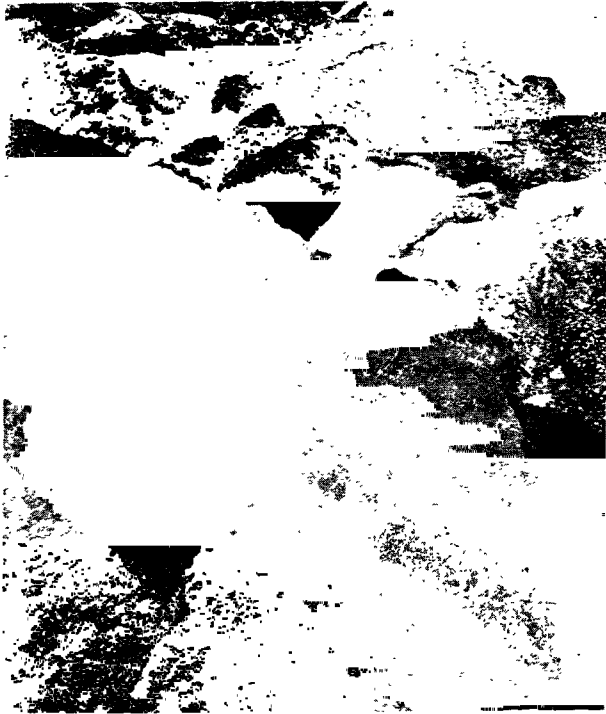

Fig. 140. Ajos Jakovos. Iron Age Sanctuary. Detail of the house, showing the two cement floors and a jar (No. 69) embedded in the wall.

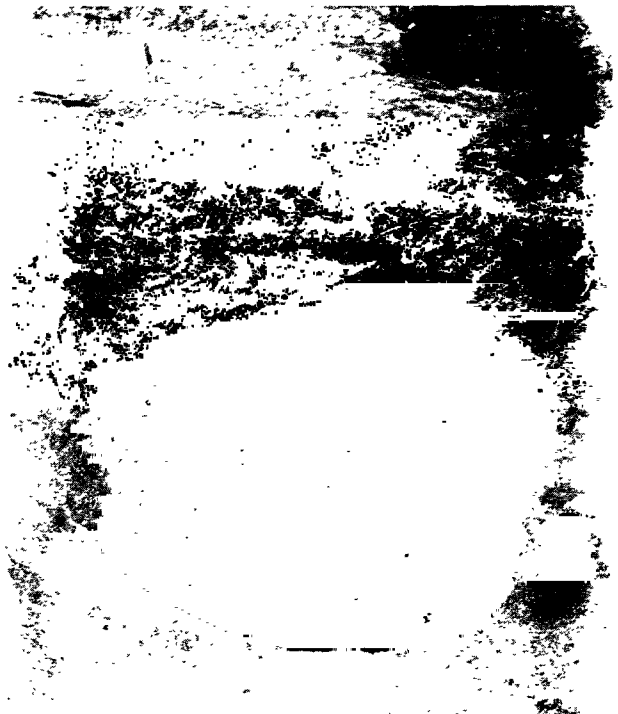

Fig. 141. Ajos Jakovos. Iron Age Sanctuary. One of the pits.

Around the building were found eight pits of peculiar shape and construction. They were numbered 1 to 8.* They are all of similar type, and a detailed description will, therefore, only be given of the best preserved one (No. 1). It is roughly circular in shape, and dug down from the surface of the soil to a depth of 1.20 m. The transverse section of the pit displays a pear-shaped figure with the maximum diameter about 0.25 m. above the flat floor, and the minimum diameter at the surface of the soil. The walls and the bottom of the pit consist of half-baked earth of a reddish colour, and are about 0.15 m. thick. These walls are the result of a fire which was lit at the bottom of the pit. Traces of this procedure were still left in most of the pits where the bottoms were blackened, and thin layers of ashes were found on the bottom, close to the walls. The pits have been closed by flat, circular stones. Such lids were found on the bottoms of Pits 1, 2, 7, and 8. The earth, filling this pit, was of loose consistency, finely pulverized, and of mainly grey colour. The pottery and other accidental finds made in the pit correspond with those found on the surface. A complete skeleton of a dog was found *in situ* in the filling. The situation of Pits 5 and 6 show that they have been dug when the house had fallen into ruins. This is made clear by the fact that the first cement floor is cut through by the diggers of pit No. 6. This circumstance and the character of the filling and the finds — especially the presence of the dog's skeleton — indicate a comparatively recent period as the prob-

* Nos. 7 and 8 are not visible on the plan as they were situated further South.

able date of all these pits. We shall have to return to the question, in the main analysis of the remains.

FINDS (PL. LXVIII)

1. Hemispherical, hollow bronze-button with a central hole. Diam. 2.2. C 4.* Surface layer.
2. Black-on-Red I (III) globular bottle with narrow neck; funnel-rim; handle-ridge, and handle from neck to shoulder. Encircling lines around neck and belly, and concentric circles on shoulder. Decoration almost obliterated. Height 5.3. C 4. Surface layer.
3. Head of terracotta statuette with projecting chin and nose, and fan-shaped head-dress. Black painted eyes. Paint worn. Height 3.8. C 4. Surface layer.
4. Head of a terracotta idol with projecting nose and eyes, and a flat cap. Nose broken, chin chipped. Height 2.8. C 4. Surface layer.
5. Head of a terracotta statuette of negroid type with projecting eyes; thick lips, and broad nose. The head-dress consists of a high, flat cap. Height 6.0. C 4. Surface layer.
6. Female terracotta statuette with trunk-shaped, hand-made, solid body; slightly projecting breasts, and lifted arms. The nose is beak-shaped, the eyes projecting, and the eyebrows marked in high relief. The dress is painted as encircling lines around arms and body, and two crossed lines on breast. The lips are marked with a broad stroke. Right ear and hand, and left arm missing. Height 18.0. C 4. Surface layer.
7. Fragment of a hand-made, solid terracotta statuette with lifted arms, and projecting breasts. Height 4.7. C 4. Surface layer.
8. The body of a hollow, trunk-shaped, wheel-made, female terracotta statuette with projecting breasts. Head and arms missing. Height 10.7. Surface layer.
9. Fragment of a moulded, female terracotta statuette. Head and lower part of body missing; surface much worn. Height 9.8. H 4. Surface layer.
10. Conical spindle-whirl of terracotta. Diam. 3.4. D 4. 80.0.**
11. Female terracotta head with large, round eyes; pointed chin; small mouth, and large nose. The hair falls backwards in two large plaits. The hair, the eyes, and a necklace are painted with dark red colour. Height 7.1. C 4. 79.3.
12. Small terracotta statuette with bell-shaped body; lifted arms, and a small, flat face. The head is bent backwards, and beard and nose project very much. Body and neck are pierced by holes, and the eyes and the beard are black painted. The dress is marked by means of two crossed lines on the front side of the body. Arms missing. Height 8.7. C 4. 77.7.
13. Circular disc of terracotta, which has served as a base for a group of small statuettes. Diam. 9.2. D 4. 80.0.
14. Upper part of a flute-playing terracotta statuette, dressed in a topped helmet. Height 7.8. D 4. 77.4.
15. The body of a terracotta statuette, as No. 8. Head and arms missing; base chipped. Height 10.8. D 4. 77.6.
16. Fragment of a very roughly modelled terracotta statuette with outstretched arms. Hands, top of head, and lower part of body missing. Height 6.0. D 4. 79.3.
17. Plain White Wheel-made jar of oblong shape with rounded base, and slightly out-turned rim. In the centre of the bottom is a small knob. The jar is closed by a cover consisting of unbaked clay and cement. Height 35.0. G-H 4. In the wall.
18. Terracotta statuette with solid, wheel-made, trunk-shaped body; projecting breasts, and a very large head. The nose is beak-shaped; the eyebrows rendered as high ridges, and the eyes round and slightly projecting. These features give the face a bird-like expression. Arms, right breast, and point of nose missing. Height 12.0. D 6. 79.2.
19. White Painted I squat, globular miniature jug with round base. Neck and handle missing; paint obliterated. Height 5.7. D 6. 79.8.
20. Scarab of blue paste with marked wing-cases, six legs and fan-shaped head. Representation worn away. Length 1.6. D 6. 79.2.
21. Seven pieces of varied glass. B 5. (Pit 1) 72.5.
22. Head of a terracotta statuette, as No. 18. Height 4.7. (Pit 7) 71.1.
23. Fragment of a terracotta statuette, as No. 16. Arms and lower part of body missing. Height 7.2. C 5. (Pit 1) 69.5.
24. Head of white limestone with grey patina. The face is very badly damaged, but the hair seems to indicate that it dates from either Cypro-Classic II or Hellenistic period. The hair is divided in the middle and combed backwards, where it is gathered in a loose knot. Height 10.8. C 4. (Pit 1) 68.2.
25. Small statuette of a frog. Both forelegs and right hind leg missing. Length 6.5. (Pit 8) 72.5.
26. Black-on-Red I (III) globular bottle with flat base; narrow neck; funnel-rim; handle-ridge, and handle from neck to shoulder. Encircling lines around neck and belly, and concentric circles on shoulder. Rim missing; paint worn. Height 4.8. D 8. 75.5.
27. White Painted I squat, globular miniature jug with round base. Neck and handle missing. Paint obliterated. Height 3.1. D 7. (Pit 4) 78.0.
28. Terracotta statuette, as No. 18, but with hollow body. A horizontal ridge on the back between the shoulders. Hands missing. Height 14.7. D 5. 79.0.
29. Small, roughly modelled terracotta statuette with solid, trunk-shaped body, and outstretched arms. The head is bent slightly backwards; the nose is large and triangular; the chin slightly projecting, and the hair arranged in a large, fan-shaped head-dress. The dress is rendered by

* Square ** Level

- encircling strokes around neck, body, and arms; the mouth is marked by a dark dot, and the eyes by encircled dots; the head-dress is painted with framed, radiating lines. Right hand missing. Head-dress chipped. Height 10.2. D 4. 79.0.
30. Fragment of a small, roughly modelled terracotta statuette with topped helmet. Height 7.3. D 5. 78.8.
31. Small, bell-shaped, wheel-made, hollow, terracotta statuette with lifted arms and projecting breasts. Head and arms missing. Height 10.7. D 7. (Pit 4) 70.7.
32. White Painted I squat miniature jug with rounded base; narrow, concave neck, and handle from neck to shoulder. Encircling lines around neck and belly; transverse lines on handle, and an encircled maltese cross on base. Height 5.8. D 7. (Pit 4) 71.5.
33. Small, roughly modelled statuette of a flying bird. Length 4.1. D 7. (Pit 4) 71.0.
34. Terracotta head, as No. 22. Height 5.2. C 5. (Pit 2) 78.0.
35. White Painted I miniature jug, as No. 32. Neck and handle missing. Height 4.2. H 3. 85.0.
36. Black Slip I biconical amphora with tall, narrow base-ring; concave neck, and two handles from neck to shoulder. The body is decorated with fluted lines from neck to base. Brown colour. Rim and one handle missing; base-ring chipped. Height 9.3. H 3. 84.0.
37. Moulded, female terracotta head. The face is round; the lips rather thick; the chin slightly projecting, and the ears adorned with several earrings. The hair is kept up in a veil and falls down in plaits on both sides of the neck. Nose missing; surface worn. Height 6.3. C 5. (Pit 2) 77.8.
38. Male head of terracotta with oval face; very projecting nose; small mouth with thick lips; slightly bulging eyes, and very small ears. The head-dress consists of a flat cap, below the edge of which the hair is visible on the forehead. On each side of the neck falls down a long, thin plait of hair. Nose chipped. Height 12.0. C 5 (Pit 2) 78.2.
39. Fragment of a terracotta statuette, as No. 16. Head and lower part of body missing. Height 4.2. D 7. (Pit 4) 69.5.
40. Moulded, female terracotta head with rounded face; large eyes, and ears adorned with several earrings. The hair is combed backwards, and falls down on both sides of the neck. Nose and chin chipped; surface worn. Height 8.4. G 3. 82.7.
41. Moulded, female terracotta head, of the same type as No. 40. Very badly worn. Height 5.0. D 2. Surface layer.
42. Female terracotta head with thin, triangular face; large nose; circular eyes, and straight mouth. The nostrils are marked by two impressed dots, and the ears consist of flat, oval knobs. The hair is combed backwards, and falls in five plaits on the back, and two large plaits on shoulder and breast. Height 8.1. D 3. 77.2.
43. Fragment of a terracotta statuette, as No. 16. Arms and lower part of body missing. Height 6.8. C 2. 77.5.
44. Terracotta statuette with hand-made, solid, trunk-shaped body; female breasts; lifted arms, and head bent backwards. The nose is large and triangular; the rest of the face is not modelled. Both arms missing. Height 9.9. C 2. 78.2.
45. Fragment of a goat's head of terracotta. Length 6.3. C 2. 78.5.
46. Upper part of a terracotta statuette, playing a double-flute, which he holds with both hands; he wears a conical helmet. Very rude fabric. Height 5.1. D 3. 78.5.
47. Birds head of terracotta, apparently a protome of a bird-shaped vase. Length 8.0. D 3. 78.5.
48. White Painted I miniature jug, as No. 32, but with concentric circles on base. Rim missing. Height 4.9. C 2. 78.0.
49. White Painted I miniature jug, as No. 48. Height 6.0. C 2. 77.5.
50. Thin bronze needle with an eyelet in one end. Length 7.2. D 5. 77.0.
51. Small terracotta statuette, as No. 16. Arms missing. Base and head chipped. Height 5.5. C 2. 79.2.
52. Small terracotta statuette of very rude fabric. The head is bent forwards; the left arm placed over the breast, and the right arm outstretched. Both hands missing. Height 6.4. C 2. 77.5.
53. Terracotta head, as No. 40. Much worn. Height 5.2. E 1. 77.5.
54. Fragment of a bull's head of terracotta. Length 4.4. F 4. 80.3.
55. Fragment of a conical spindle-whirl of ivory with incised, concentric circles. Length 2.5. Found on the bottom of Pit 8.
56. White Painted I miniature jug, as No. 48. Rim and handle missing. Paint worn. Height 5.3. D 3. 77.5.
57. Small, conical bowl of terracotta with pointed base. Diam. 2.9. D 3. 78.0.
58. Fragment of a terracotta horse. D 3. 77.0.
59. Bronze fragment, and a nail of iron with flat head and square section. Length of nail 5.2. F 3. 80.0.
60. Fragment of a moulded, naked, female statuette of terracotta. Length 14.3. F 4. 80.0.
61. Fragment of bronze leaf. Length 4.2. F 3. 79.5.
62. Bronze fragment. Length 1.3. F 3. 79.5.
63. Bronze leaf pierced by holes. Fragmentary. Length 6.3. G 5. 79.5.
64. Scarab of black steatite with marked wing cases, and incised lines on head. On the base is an incised figure of a stag (chamois) moving to the right, long horns, represented by a row of dots, reaching almost onto the back. An incised line round the edge. Length 1.8. D 2. 79.2.
65. White Painted I miniature jug, as No. 32. Rim and handle missing. Height 5.2. F 6. 82.0.
66. Fragments of a jar, as No. 17. G 3. In the wall.
67. Fragments of a jar, as No. 17. G 5. In the wall.
68. Fragments of a jar, as No. 17. G 5—6. In the wall.

- 69. Plain White Wheel-made jar, as No. 17. Height 32.3. F 6. In the wall.
- 70. Fragments of a jar, as No. 17. F 6. In the wall.
- 71. Double-conical bead of hard, black stone, pierced by a hole in the longitudinal axis. Length 1.9. F 6. 85.0.
- 72. Conical seal of blackened steatite with roughly rounded top, and flat, circular base. Three incised circles with central dots on base. Length 1.4. D 1. 73.0.
- 73. Double-conical spindle-whirl of terracotta, adorned with zigzag incisions. Diam. 2.7. E 2. 73.5.
- 74. White Painted I shallow bowl with flat base; rounded outline; plain rim, and two horizontal handles on body. Encircling lines around rim and base; an encircled spiral inside the bottom; latticed triangles between the handles, and a maltese cross outside the bottom. Handles and pieces of rim missing. Paint worn. Diam. 10.4. G 3. Surface layer.
- 75. Female terracotta head, as No. 40. Much worn. Height 6.4. Surface layer.

The most interesting finds are the fragmentary sculptures of terracotta. From a typological point of view, they can be divided into five types which are characterized by certain features: —

- Type 1. Wheel-made statuettes with large globular heads. They are generally hollow.
- Type 2. Hand-made small statuettes of very rough workmanship. (Snow-man technique)
- Type 3. Moulded, plank-shaped statuettes. These are always female.
- Type 4. More carefully modelled statuettes of medium size.
- Type 5. Statuettes of animals.

In order to obtain a convenient summary of the Object Register and, above all, to make the distribution of the terracotta statuettes among the above-mentioned five classes clear, the following diagram is arranged: —

Sculpture					Pottery					Bronze				Miscellaneous objects of terracotta		Glass	Stone	Ivory	Glyptics		
Terracotta					Limestone	Wh. P. I	Bl. Sl. I	Bl.-on-R. I (III)	Pl. Wh.	Needle	Leaves	Button	Fragments	Spindle-whirls	Bowl	Disc	Fragments	Bead	Button	Seal	Scarabs
Type 1	Type 2	Type 3	Type 4	Type 5																	
4. 8	3. 6	9. 37	5. 11	25. 33	24	19	36	2	17	50	61	1	59	10	57	13	21	71	55	72	20
12. 15	7. 12	40. 41	38. 42	45. 47		27		26	66		63		62	73							64
18. 22	14. 16	53. 60		54. 58		32			67												
28. 31	23. 29	75				35			68												
34	30. 39					48			69												
	43. 44					49			70												
	46. 51					56															
	52					65															
						74															
-9	-15	-7	-4	-6	-1	-9	-1	-2	-6	-1	-2	-1	-2	-2	-1	-1	-1	-1	-1	-1	-2

ANALYSIS AND CHRONOLOGY

The finds give full evidence, that the excavations have revealed a cult place. The type of sanctuary is, evidently, the house-chapel.

On basis of the data given in the architectural description above, and of the following analysis of the sections, the architectural development can be followed in detail.

Section I crosses the chapel obliquely, and shows that the first cement floor and the

four exterior walls are founded directly on top of thick layers of debris. In the first stage of its development the chapel seems to have contained only one room. We know nothing of the details of its equipment, a fact that is very natural, seen in the light of the following development. The next stage is represented by the second cement floor (Level 79.3) and the revetment of the walls. Now, the jars Nos. 17 and 66—70 were built into the walls at the same time as the revetment was applied. Full evidence of this can be seen, as the jars, which can be considered as wall-offerings, were found closed by lumps of clay, and by the cement of the revetment (Fig. 140). From this circumstance it can be concluded that of the first chapel, there remained only the floor and the foundations of the walls, when the second stage was introduced by the so-called second cement floor and the revetment. It can further be stated, that the foundations of the destroyed first chapel were carefully cleared of the covering debris as no earth was found between the two cement floors. This debris was, apparently, shovelled out round the house where it has formed the lower portions of the layer found at the foot of the walls. The stones visible in that stratum, in Square H 4 of Section I, are building material from this first chapel.

To the second chapel belong also the transverse wall and the altar. The chapel had thus a sort of pronaos in front of a cella. The position of the door and of the altar — for so the podium by the W. wall must be interpreted — shows the complete lack of axiality in the arrangements. It is very probable that both rooms were roofed, to judge from the excellent quality of the floors, but no traces of the original roof were found. If there was a front wall or no, cannot be stated, but I am inclined to suppose that we have to reconstruct the entrance of the chapel as a simple arrangement *in antis*.

The third floor (Level 83.1) indicates a third building period of which our knowledge is very scanty. The floor lies immediately below, or in the surface soil, and is to a great extent turned up by the plough. Probably, the layer of stones left intact was the substructure for a third cement floor, which has been removed as it was a great obstacle for the tillage of the soil. Between the second cement floor and this floor, is a layer of intact debris from the period of the former; but above the latter the thin layers are not *in situ*. This seems also to be the case round the walls outside the chapel, where sherds from very different periods lay mingled with each other. The disorder of this layer is partly due to the presence of the above mentioned pits, which are certainly of comparatively recent date. A valuable chronological item are the glass-fragments and the limestone head found in Pit 1. The pits are dug through all the layers, and the earth shovelled up at their construction, was spread over the neighbouring area: and thereby the mixed contents of the upper layers around the chapel are explained. There remains, however, the question of what purpose these pits served. There is nothing that denotes their having any direct connection with the sanctuary. Their contents are decidedly against the hypothesis that they were *favissae* for destroyed votive gifts, or for ashes from the altar. Moreover, they are spread all over the field and do not display any systematic arrangement about the chapel. It has already been pointed out that Pits Nos. 5 and 6 were dug after the definite destruction of the house-chapel.

In modern Cyprus, there is still in use in remote places, a system of preserving grain by digging vaulted pits in the earth of the same type as those here met with. When the pit is dug a fire is lit at the bottom in order to strengthen the walls and to disinfect the room. The ashes are cleared out, the pit is filled with grain, and finally closed by a flat stone fixed with mud-mortar. By applying this system, the grain is said to keep fresh for a very long time. It seems very probable that we have to deal with early specimens of these so-called "vouffes". That this field was used for the purpose might be due to the enormous quantities of potsherds found in the layers on top of which the sanctuary was built. Their presence doubtless facilitated the construction, and made the walls of the pits more solid. Perhaps the tradition of sanctity of the field still lived when it was used for its new purpose, and this reason may have contributed to the choice. The precious supplies of grain were put under the shelter of the old local god. If this theory holds good, it is evident that all the objects found in the pits were thrown in accidentally when the "vouffes" were no longer used. They belonged originally to the surface layer, and were carried into the cavities by rain-water.

Let us now consider the ceramic material from a chronological point of view. The sherds from two of the most representative squares are here presented in details. Tests were made in several other squares and the result was everywhere the same. In Square C 4 were found some sherds of Iron Age pottery of the classes White Painted III and IV, but on the whole, the material from the two Squares H 4 and D 4 can be considered conclusive.

Square D 4.					
83.0—81.0	Undetermined	c. 85 %			White Painted Wheel-made 7
Bronze Age	Base-ring	1			Bichrome Wheel-made 3
	Black Slip Wheel-made	14	73.0—71.0	Undetermined	c. 25 %
	Red Slip Wheel-made	4	Bronze Age	Black Slip II	132
Iron Age	White Painted I—II	25		Red Slip	77
	Red Slip I (III)	2		Black Slip Wheel-made	154
	Black Slip I	1		Red Slip Wheel-made	88
	Bichrome I	1		White Painted Wheel-made	15
				Bichrome Wheel-made	3
79.0—77.0	Undetermined	c. 80 %			
Bronze Age	Black Slip II	6	Square H 4.		
	Red Slip	2	83.0—80.0	Undetermined	c. 90 %
	Red-on-Black	2	Bronze Age	Black Slip II	2
	Base-ring	6	Iron Age	White Painted I	2
	Black Slip Wheel-made	46		White Painted II—III	2
	Red Slip Wheel-made	32	80.0—77.0	Undetermined	c. 60 %
Iron Age	White Painted Wheel-made	1	Bronze Age	Black Slip Wheel-made	102
	White Painted I—II	41		Red Slip Wheel-made	78
	Black-on-Red I (III)	1		White Painted Wheel-made	12
	Grey Bucchero	2		Bichrome Wheel-made	6
77.0—75.0	Undetermined	95 %	Iron Age	White Painted I—II	22
Bronze Age	Black Slip Wheel-made	7	77.0—76.0	Undetermined	c. 25 %
	Red Slip Wheel-made	9	Bronze Age	Black Slip II	7
75.0—73.0	Undetermined	c. 85 %		Red Slip (one wishbone-handle)	17
Bronze Age	Black Slip II	14		Black Slip Wheel-made	227
	Red Slip	13		Red Slip Wheel-made	226
	Black Slip Wheel-made	62		White Painted Wheel-made	25
	Red Slip Wheel-made	40		Bichrome Wheel-made	8

76.0—74.0	Undetermined	c. 35 %		Red Slip Wheel-made	61
Bronze Age	Black Slip II	8		White Painted Wheel-made	5
	Red Slip	12		Bichrome Wheel-made	7
	Red-on-Black	1			
	Black Slip Wheel-made	221	72.0—70.0	Undetermined	c. 25 %
	Red Slip Wheel-made	204		Black Slip II	23
	White Painted Wheel-made	24		Red Slip	7
				Black Slip Wheel-made	18
74.0—72.0	Undetermined	c. 20 %		Red Slip Wheel-made	8
	Black Slip II	37		White Painted Wheel-made	2
	Red Slip	24		Bichrome Wheel-made	1
	Black Slip Wheel-made	92			

In both squares we have pure Bronze Age layers below level 77.0. At this level lies the first cement floor, the exterior walls of the chapel, and the central part of the detached wall. From this level upwards, there was a mixed debris containing both Bronze Age sherds and sherds from Cypro-Geometric I to Cypro-Geometric III (Square C 4); and in this layer lay all the objects found outside the walls, except for the seal (No. 72) and the spindle-whirl (No. 73) which were found in the pure Bronze Age stratum. But how should this stratum be dated?

The most striking characteristic of the pottery of the layer is that more than 80 % of the registered sherds are wheel-made. To this percentage should be added at least 85 % of the undeterminate sherds, which consist of wheel-made wares in this proportion. Thus, of the potsherds about 90 % are wheel-made. The presence of Black Slip II and of Red Slip Ware is interesting, as well as that of a few sherds of Base-ring Ware in the upper layers of Square D 4.

Fortunately we know the local characteristics of the M. C. III pottery, both from the necropolis of Melia and of the bothros below the floor of the Bronze Age Sanctuary (cf. above p. 302 and p. 356). The latter especially must be dated to a late stage of Middle Cypriote III period because of the presence of the White Painted V Ware. In the bothros of the Bronze Age sanctuary all the sherds were hand-made: this is sufficient to show that they cannot be contemporary, and the layer must be later than Middle Cypriote III.

The main feature of the Late Cypriote II period in the necropolis and in the Bronze Age Sanctuary is the frequent occurrence of Levanto-Helladic Ware. This ware is missing in our Bronze Age stratum which must, consequently, be earlier than Late Cypriote II. Thereby the layer is dated approximately to Late Cypriote I, a date which is corroborated by the Base-ring sherds found in Square D 4.

But such an overwhelming majority of wheel-made wares is not met with in Cyprus at this epoch. It is a decidedly non-Cypriote trace, and must also be interpreted as the result of the presence of foreigners. The question will be dealt with further on, but it may be pointed out here that this layer, which is probably, a rubbish heap from a destroyed settlement, is the only remainder of the advanced stage of Late Cypriote I found in Ajios Jakovos. Both in the tombs and in the Bronze Age Sanctuary they are missing.

To date the house-chapel, we are referred to the finds, to the potsherds of the mixed layer around the house, and to the sherds found between the second cement floor and the

third floor which is an intact stratum. As regards the mixed layer we have seen that it contained sherds of White Painted I—IV Wares, and the pots found there are mostly late specimens of White Painted I Ware. Of the terracotta sculptures, specimens of Types 1, 2, 4, and 5 are found at varying levels in the same layer. Type 3, however, is mostly represented inside the chapel. They were found between the second cement floor and the third floor. They can, therefore, be attributed to the end of the period represented by the second cement floor. As Types 1 and 2 from stylistic point of view, must be placed earlier than Type 3, it seems reasonable to ascribe them to the period of the first cement floor. The same sort of idols is also found in Tombs 415 and 419 at Lapithos (cf. above pp. 223 and 234). This floor was cleared when the second was laid, and these statuettes were probably thereby brought in the position where they were actually found. Type 4 is more difficult to place. They were found in the same layer as Types 1 and 2, but show stylistical influence from Type 3. As the archaeological arguments are undecided, it seems reasonable to date them to an epoch contemporary with, or later than, Type 3, i. e., to the end of the period of the second cement floor. This floor is dated by the latest sherds in the intact layer below the third floor to Cypro-Geometric III. With this date the wall-offerings Nos. 17 and 66—70 agree: the shape of jar is, as far as I know, not met with in Cyprus before, but has its closest parallel in Palestine, where it is datable to the XXIIth Dynasty.¹ To the first cement floor belong, presumably, the very late specimens of White Painted I Ware, and the floor seems therefore to date from the transition between Cypro-Geometric I and II.

The third floor cannot be dated with any certainty. The limestone head No. 24 seems to be the latest find of the sanctuary. It is datable to Cypro-Classic II or even Hellenistic times. This yields, however, only a *terminus ante quem* for the floor.

E. S.

N I T O V I K L A

The Fortress

INTRODUCTION (Plan IV, 2)

East of the small river running beside the temple-site of Cura, some poorly wooded *Hali-*land, interspersed with small plots of cultivated earth, extends along the coast south of Korovia; it is known to the villagers as Nitovikla or Nichtovikla. This name more exactly designates a low hill on the western border of the area overlooking the plateau, and rising some 25 m. above the sea. Several travellers have noted the place and, especially some megalithic ruins appearing above earth and made almost inaccessible by abundant growth of thorny bushes. Hogarth first pointed out the obviously fortified character of the place.¹

During my stay in the Carpass in the late spring of 1928, I first became acquainted with the place, and was attracted by its many unusual features. The small burial ground² on the eastern edge of the area contained some rifled tombs which were said by the villagers to have yielded rich finds. An excavation was tempting, but the program of the Expedition was planned a long time ahead, so the place was kept in mind as an eventual scene of operations. The only digging carried out at that time, was the negative trial at the sacked temple-site of Cura, and the clearing of a built tumulus-tomb at Trachonas (see below pp. 461 ff.). The neighbourhood was investigated topographically and among other places, the tomb-fields of Paleoskoutella and Kountoura Trachonia were found, but not excavated (see below pp. 416 ff. and below pp. 439 ff.). It was decided that the burial grounds and the settlement should be excavated later on, and in the autumn of 1929, we set to work. Excavations started at the tombs of Nitovikla; thereafter the Fortress was cleared, and, finally, the burial grounds of Paleoskoutella and Kountoura Trachonia were excavated.

By cutting down the low bushes that covered most of the site, the outlines of the ruins were to a certain extent traceable, and the following observations as regards the main features of the site, were made before the excavation.

The stronghold of Nitovikla is situated in the south-west corner of an extensively fortified plateau, confined by a strong wall on the north side, leaving a narrow passage between the wall, and some high, almost perpendicular cliffs, running parallel with it. The east corner of the wall is marked by a large, square bastion, now completely ruined. To the south of this bastion the foundations of an other, equally large, can still be traced on the



Fig. 142. Nitovikla. The stronghold seen from the West.

surface: this last is the starting point for the south wall (Fig. 143) which connects the bastion with the Nitovikla fort. The western rampart of the enclosed area can only be traced as a considerable mound on the ground, running from the hill towards the North; the east side is occupied by a small necropolis surrounded by walls of smaller dimensions than the main enclosing ramparts.

The enclosed area is roughly rectangular in shape extending east and west for about 400 m., and north and south for 100—200 m. The highest point is the south-west corner — the Nitovikla fort.

Only one gate leads into this fortified dwelling-place, and to enter, it is necessary to approach it either through the long corridor outside the north wall, or by means of a rock-cut passage on the west side. The western approach comes from the low river valley and rises steeply upwards, passing through a narrow, outer gate, and a small, square, open room (Fig. 144); it ends with a right-angle turn to the right in front of the main inner gate. The passage along the north wall can only be entered conveniently from its eastern end, up to which a rock-cut road leads from the fertile plain, now occupied by the vast fields of the modern village of Gallinoporni. Distinct cuts in the rock of the road, show this entrance to have been the most frequently used during time of occupation.

In the western part of the enclosed area there is a well, built of irregular stones, and flanked by substructures for a winch. The villagers of Korovia told us that in this well, which is now half ruined, several bronze tools had been found, the description of which seemed to fit certain types belonging to the Late Cypriote period.*

On the ground inside the walls potsherds, fragments of hand-mills, stone pithoi, and other accessories of a dwelling place were occasionally found, and few heaps of rough building-stone indicated the site of some large houses. All the surface finds belong, seemingly, to Middle and Late Cypriote times.

* A spade, a plough-share, and some axe-heads.



Fig. 143. Nitovikla. The main southern rampart.



Fig. 144. Nitovikla. The outer gate of the western approach.

The masonry visible on the surface is of two types: —

1. A cyclopean type of wall is to be found on the north and south ramparts where huge blocks are roughly fitted together without mortar. Sometimes the walls have a considerable thickness and consist of a core of smaller stones, filling the space between the cyclopean blocks.
2. Small walls used for habitations etc. the material of which is strewn all about the place; specimens can still be seen at the well. No mortar is used and the stones are small and rough.

Some trial trenches in the neighbourhood of the well and the gate showed that the place could not have been very densely inhabited. No foundations of houses were found and the earth consisted of a hard, brownish, almost sterile clay covering the rock to a depth of about 1 m. In fact, the only remains of house foundations seem to be the large stone-heaps mentioned above. Evidently the place had not been permanently inhabited, and the large area seems quite superfluous for the few houses actually built within its limits, but it served as a refuge and a fortified camping-place for the surrounding population in times of war: it was a so-called "*Fluchtburg*". Further support for this explanation is found in the exceptionally small extent of the burial ground, clearly defined by its surrounding walls. Some fifteen tombs only were found in the necropolis, all of a small and poor type.

There was little to be gained by a total excavation of the whole inclosed area. The work had to be concentrated on certain spots, and the two places chosen for a thorough investigation were the necropolis at the east end of the area, and the hillock in the south-western corner, on which the fortress was found. A more superficial examination was made of the western entrance and some sections of the main rampart.

The following is a description in detail of the fortress.

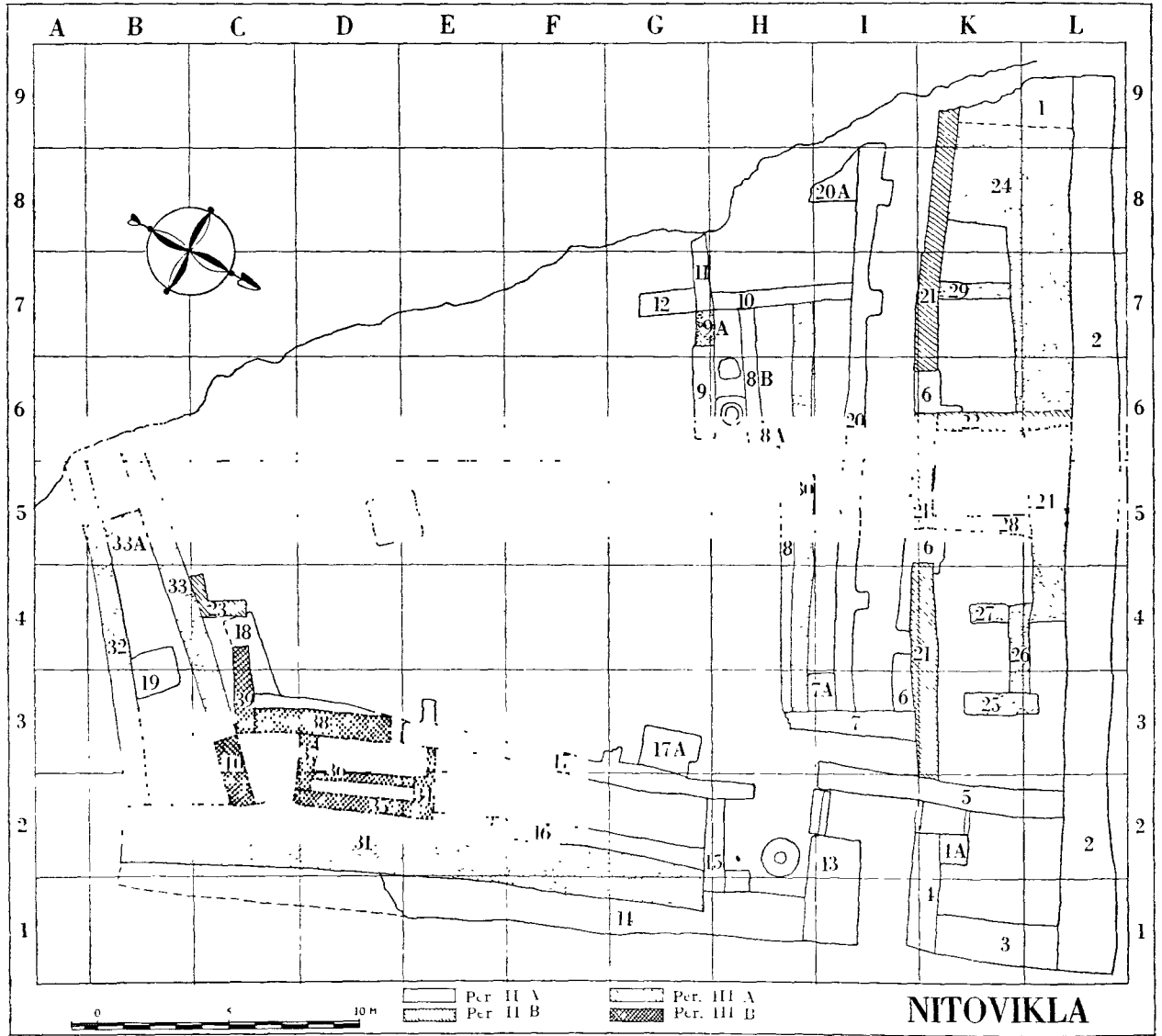

Fig. 145. Nitovikla. Analytical plan of the fortress.

ARCHITECTURE

DESCRIPTION OF THE WALLS* (PLAN XV, 1)

Wall 1.** Height 0.40. Width c. 1.80.

It is badly damaged and only a small part of its original length is preserved. The W. face is dispersed (cf. below Wall 20, p. 379) and the S. end is only a break. It is founded on the rock, and built of local sandstone rubble of medium size, joined together without mortar in irregular layers. The corner stone of the N. end was found down the hill-side. It was a carefully dressed block of fine local sandstone measuring 1.60 x 1.40 x 0.45 m.

* The description of Walls 19-33 are based on notes and observations made by Miss Joan du Plat Taylor, now Ass. Curator of the Cyprus Museum.

** The figures of the walls refer to the analytical plan, Fig. 145.

Its position in the wall is traceable, thanks to a platform of equal dimensions cut in the rock. The wall can be reconstructed similarly to Wall 2. The wall is bonded into Wall 2.

Wall 2. Height 1.88. Width 2.28—1.80. (Plan XV, 3; Fig. 146).

The wall is built on the uneven natural rock that reaches its summit at the middle of the wall: it is deepest at the S. W. end. This circumstance determined the construction of the wall. At this corner the base of the wall is brought up to the level of the summit of the rock by means of levelling courses of medium-sized rubble of local sandstone, without mortar. There are no distinct rows of stone, but the wall is stepped back in large courses. The lower sections are slightly broader than the upper ones. At the opposite end a similar, but less regular construction was used: on top of the horizontal base thus produced, are founded rows of huge, cyclopean blocks forming the main, exterior façade. The interstices are filled with smaller stones, but no mortar is used. The S. W. end is rather damaged, but the N. E. angle is fairly well preserved. It is built up of ashlar blocks, the largest of which measures $1.60 \times 1.10 \times 0.55$ m., and is slightly hollowed out on its upper surface. Close to this end, the wall has fallen down so that its transverse section can be studied: it reveals the fact that it is a shell-wall, the interior face of which is constructed of medium-sized rubble without mortar. The exterior is as above-described. Between these two shells is a core of smaller stones and earth-filling. The wall is bonded into Walls 1 and 3.

Wall 3. Height 1.05. Width 1.60. (Plan XVI, 2; Fig. 148).

The wall is of practically the same type as that previously described, but of ruder workmanship. The N. end, close to the angle made with Wall 2, is in a rather bad state of preservation, and the whole wall overhangs slightly. It is bonded into Walls 2 and 4.

Wall 4. Height 1.80. Width 0.98. (Plan XVI, 3).

The wall is built of local sandstone rubble of varying size, bedded in much mud-mortar. Occasionally pieces of conglomerate is used. No distinct lines of stone are found in the wall. The N. E. end, joining Wall 3, ends with a large megalith of sawn conglomerate ($1.95 \times 1.40 \times 0.35$ m.), based on a large sandstone block with rustic façade ($1.52 \times 1.00 \times 0.40$ m.). The megalith tapers slightly towards the top. The opposite end of the wall stands free, and is very solidly built of ashlar poros masonry in a somewhat irregular and modified system of headers and stretchers. Thus the sequence is as follows (counting from the base): two headers, one stretcher, three headers, one stretcher, one header. Some of the headers are considerably narrower than the rest of the blocks.

The wall can be considered as a kind of shell-wall, but not in the same strict sense of the word, as in Walls 2 and 3. The core consists of small stones and earth, and the shell is constructed as in the above-mentioned façade, but as the total thickness of the wall is only about one meter, the differentiation of the two elements is not so clearly marked as in Walls 2 and 3. The wall is bonded into Wall 3.

Wall 4 A. Height 0.46. Width 1.15.

This wall consists of a square podium built of rubble, except for a roughly dressed corner stone of poros. No mortar is used. The wall abuts on Wall 4.

Wall 5. Height 0.46. Width 0.98.

This wall is of the same type, material, and construction as Wall 4. It overhangs slightly to the East. The S. end is built of ashlar poros masonry, but the stones are square, and not arranged as headers and stretchers. The wall abuts on Walls 2 and 21.

Wall 6. Height c. 1.40. Width c. 1.00.

This wall is just visible above the surface of the upper floor-level, and could thus, only be studied in detail in the section revealed by the main trench. For more than the half of its total length it is hidden below the later Wall 21. There are two gaps in the superimposed wall, showing short sections of this wall, close to the transverse Walls 22 and 28 (cf. below p. 379). At each of these points is a buttress facing N.: the W. buttress is partly hidden below Wall 22 (Fig. 151). It is founded on the rock and built of the local sandstone rubble. The average size of the stones is less than those of Wall 5, and no attempt to arrange them in distinct rows could be traced. No mortar is used. The wall is bonded into Wall 7.

Wall 7. Height c. 0.40. Width 1.00.

The wall corresponds closely in all structural points to Wall 6. The measured height is its maximum projection above the later floor-level. The wall is bonded into Walls 6 and 8.

Wall 7 A. Height 0.40. Width 1.09.

The wall is a rectangular podium of sandstone rubble founded on the rock and abutting on the surrounding walls. It is partly covered by Wall 30.

Wall 8. Height 1.48. Width 1.38.

This wall is of the same construction and material as the two previous ones, but of larger dimensions. It is founded on the rock. The corner bonding it to Wall 7 is partly destroyed, and Wall 7 is throughout covered by the later Wall 26. Width, height, and face can therefore only be studied in the portion laid bare by the main trench. The wall is bonded into Walls 7 and 8 A.

Wall 8 A. Height c. 0.80. Width 0.90.

This wall is only a continuation of Wall 8 and is characterized by the same material and structure as that. It is founded on the rock and bonded into Walls 8 and 8 B.

Wall 8 B. Height 0.71. Width 0.64.

The wall is of rubble masonry of local sandstone as in the previous ones, but its width is considerably less. The S. face of the wall is lined with larger stones than the opposite side. The W. end is only 0.20 m. high and has served as a threshold for a doorway, about 1.75 m. wide. The wall is founded on the rock and bonded into Wall 8 A; its W. end (the threshold) abuts on Wall 10.

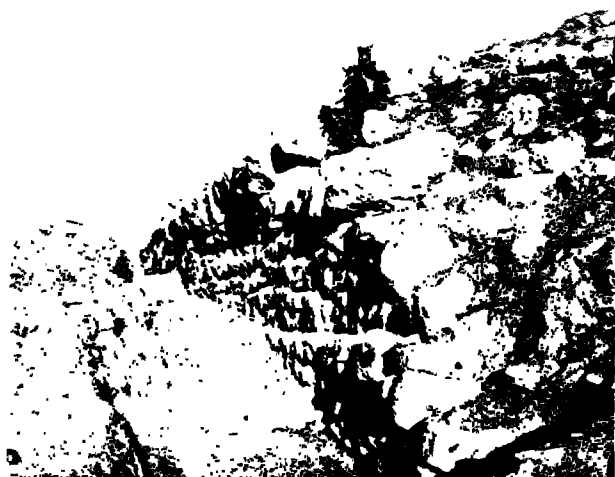

Fig. 146. Nitovikla. Wall 2, seen from the West.

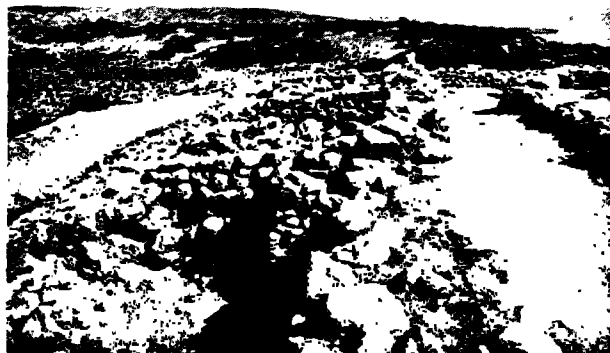

Fig. 147. Nitovikla. Wall 21 and the so-called Northern Casemates from the West.

Wall 9 and 9 A.

Height 0.77. Width 0.95.

Construction and material are the same, as those of Wall 8. Its E. end is damaged, and its W. part, Wall 9 A, a narrow filling resembling Wall 8 B. There is no bond between the W. section and the main body of the wall.

Wall 10.

Height 1.65. Width 0.70.

It is founded on the rock, and built of sandstone rubble without any attempt at definite courses. The stones are of medium size, and because of the narrowness of the wall, the facing stones meet in the middle: no mortar is used. The wall is bonded into Walls 11 and 20, and Wall 30 abuts on it.

Wall 11.

Height 0.64. Width 0.70.

The wall is of similar construction and material to Wall 10. It is founded on the rock and is bonded into Wall 10.

Wall 12.

Height 0.31. Width 1.00.

The wall is very fragmentary, and only its S. end is preserved to the height of one course of stones. The original length is also uncertain. It is founded on the rock and built of sandstone rubble of medium size, mixed with a few pieces of harder stone.

No mortar is used. The construction is that of a modified shell-wall of the same type as the above-described Walls 4 and 5, i. e., two faces of larger stones enclosing a core of small stones with earth-filling. The wall abuts on Wall 11.

Wall 13.

Height 1.88. Width 2.10. (Plan XVI, 4).

The wall is founded on the rock and faces Wall 4. It is like that wall in many details: thus, its N. E. corner is flanked by a megalith of sawn conglomerate, resting on a podium of a single poros block with rustic face. The dimensions of the megalith and of the podium are $1.20 \times 1.47 \times 0.45$ m., and $0.33 \times 1.46 \times 0.92$ m. respectively. The megalith is cracked

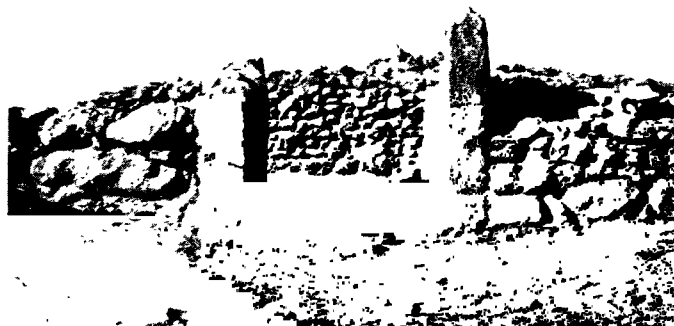

Fig. 148. Nitovikla. Walls 3 and 14 with the monoliths of Walls 4 and 13 (the gate).



Fig. 149. Nitovikla. Base of monolith of Wall 4.

at its E. end. The two faces of the wall are built in a similar technique. The material is sandstone rubble with a few pieces of conglomerate bedded in much mud-mortar. A certain attempt at courses is observed in the masonry. The W. end of the wall is built of ashlar blocks of poros in the angles where the order between headers and stretchers is the following (counting from the base): one header, two stretchers, one header, one stretcher, one header, one stretcher.

Between these strong faces a filling of smaller rubbles, chips, and earth is enclosed. The wall is a typical shell-wall, and is bonded into Wall 14.

Wall 14.

Height 1.25. Width 1.60. (Plan XVI, 2).

The exterior face is built of cyclopean blocks based on a levelling course of smaller stones. The construction thus resembles that of Wall 2, but as the ground here is almost level, the base is very low. The S. end of the wall is demolished. Some projecting cyclopean blocks indicate the joint between this wall and the main S. rampart (see above p. 372). Wall 31 is built upon, and partly covers this wall, and the inner face is only visible at its northern extremity. It is built of fairly large sandstone rubble: the core of the wall consists of stones of medium size with earth-filling, and is a direct continuation of the interior filling of Wall 13. The wall is founded on the rock, and bonded into Walls 13 and 15.

Wall 15.

Height 0.90. Width 0.90.

The wall is founded on the rock, and built of local sandstone rubble. The facing stones are slightly larger than those of the core and sometimes meet in the middle. Each end of the wall is provided with a buttress projecting from the N. façade, which do not reach as high as the wall itself. The wall is bonded into Walls 14, 16, and 17.

Wall 16.

Height 2.65. Width 0.80.

The S. end of the wall is hidden below Wall 31, and probably also damaged and demolished as is Wall 14. It is founded on the rock, and built of sandstone rubble of medium

size without mortar. The thickness of the wall is unequal, its N. end being slightly thinner than the middle section. At the narrow part, the facing stones are larger than in the wide part, and therefore, the latter has a narrow core of small stones with earth-filling. The wall is bonded into Wall 15.

Wall 17. Height 2.40. Width 0.70.

This wall is founded on the rock, and its S. end is hidden below Wall 35. Material and construction are the same as Wall 16. The W. face is provided with two narrow buttresses, which are both bonded into the wall, but not founded on the rock. The thickness of the wall is, like that of the previous one, not perfectly regular. The N. extremity is only 0.55 m. thick. The wall is bonded into Walls 15, 17 A, and 18.

Wall 17 A. Height 0.40. Width 2.10.

This wall is a low, square platform, jutting out from the N. end of Wall 17. It is built of rubble of sandstone of medium size without mortar. The N. angle is bonded into Wall 17, but the construction is not founded on the rock.

Wall 18. Height 0.60. Width c. 0.80.

This wall is in a very poor state of preservation. The S. face of the wall is demolished for almost its total length; the W. end is built over by the Wall 23, and Wall 39 is to a great extent founded on it. Material and construction are, as far as can be seen, the same as those of Wall 17, to which it is also properly bonded.

Wall 19. Height 0.95. Width 1.60.

The wall is a short, isolated fragment of a broad wall built of large rubble without mortar. It is founded on the rock, and its S. edge is partly covered by the inner side of Wall 32. It can be reconstructed in approximate accordance with Wall 2.

Wall 20. Height 2.20. Width 0.70—0.75.

The wall is founded on the rock and built of rubble of medium and small sizes. No mortar is used. The wall is not of the same thickness everywhere, and does not run rectilinearly. The middle section bulges on both sides. The W. extremity, like all the walls in this region of the fortress, is in a very poor state of preservation, and practically peters out on the rock. Three square buttresses are built on the N. face of the wall, two at the W. end, and one at the E. end. They are all bonded into the wall. The wall abuts to Wall 7, and is bonded into Walls 10 and 20 A.

Wall 20 A. Height 0.30. Width 1.60.

This wall is in a very fragmentary state: its present height shows only two courses of stone. The material is the usual local sandstone rubble without mortar, but it seems to have been of the same type as Wall 2. It is founded on the rock, and bonded into Wall 20.

Wall 21. Height 0.60. Width 0.80—1.05. (Fig. 147).

The wall is founded on top of Wall 6, except for the extreme E. end where it rests on a floor. There are two gaps in the middle section of the wall, leaving the underlying Wall 6 bare. The gaps are situated W. of the transverse Wall 22 and E. of the similar Wall 28.

The material is medium-sized blocks of local sandstone mixed with several pieces of sedimentary conglomerate. In spite of its narrowness, it is constructed as a sort of shell-wall, with larger facing stones enclosing a core of small stones and earth, and a certain order of layers is kept. The W. end is rather destroyed. The wall is bonded into Wall 22.

Wall 22. Height 0.55. Width 0.70. (Fig. 151).

This wall is founded on top of a floor, resting on masses of debris (cf. below p. 385). The material is sandstone rubble with some pieces of conglomerate. The stones are laid in fairly distinct courses and are of roughly equal size. No mortar is used. The N. part of the wall is hidden below Wall 24, and its S. extremity is bonded into Wall 21.

Wall 23. Height 0.45. Width 0.55.

The wall is angular and founded partly on debris, partly on the S. W. end of Wall 18. The opposite end is cut through, and damaged by Wall 33. It is very poorly constructed of sandstone rubble without mortar, and is not joined, or bonded to any other wall.

Wall 24. Height 1.20. Width 1.20—2.40.

This wall is a revetment wall built against Wall 1 and 2 and covering their inner faces and edges. Its S. edge, i. e., its visible face, is built of sandstone rubble without mortar. It serves as a shell for an interior core of smaller stones and earth-filling. Its W. extremity is very badly damaged and peters out on the rock. Its borders are, however, clear. It turns southwards and forms a large, nearly square platform with sides about 3.25 m. long. The wall is bonded into Walls 27, 28, and 29, covers the extreme north of Wall 22, and abuts on Wall 21.

Wall 25. Height 0.85. Width 0.80.

The wall is founded on a floor that rests on debris. It is rather damaged and the facing stones have fallen from the upper courses, thus revealing the crude core of small stones and earth. The material is medium-sized rubble of local sandstone, without mortar. The wall is bonded into Wall 26.

Wall 26. Height 0.85. Width 0.75.

This wall is founded on the same rammed floor as the previous one, and is of the same material and structure. The state of preservation is rather bad, especially at the W. extremity. The wall is bonded into Walls 25 and 27.

Wall 27. Height 1.05. Width 0.75.

The wall is founded on the same floor as the two previous ones, and material and construction are the same. The S. end of the wall is partly demolished. The wall is bonded into Walls 26 and 24.

Wall 28. Height 1.20. Width 0.75.

The S. part of the wall is almost founded on the rock, but as the rock falls away to the North, the contact between rock and wall ceases. There it is founded on layers of debris. It is built of sandstone rubble, bound with a small quantity of mud-mortar. The stones

are of fairly equal size and, to a certain extent, laid in distinct courses. The wall abuts on Walls 6 and 21, and is bonded into Wall 24.

Wall 29.

Height 1.60. Width 0.70.

This wall is founded on the rock and the material is local sandstone and, sporadically, conglomerate. No mortar is used. In the lower section, the wall is built in fairly regular courses, but becomes more irregular near the top. It abuts on Walls 6 and 21, and is bonded into Wall 24.

Wall 30.

Height 1.50. Width 0.80.

This wall is based on Wall 8 for the greater part of its length, but the western third is founded directly on the rock. The material is local sandstone rubble built without mortar. The stones are not arranged in courses. The facing stones are, as usual, somewhat larger than those of the core, which also contains some earth as a filling material. The wall abuts on Walls 7 and 10.

Wall 31.

Height 0.95. Width 2.45.

The wall is, at its S. end founded on the rock, but at the opposite end based on the remains of Wall 14 for more than the half of its total length: it is built partly over, partly against Wall 16, and is a typical shell-wall. The above-mentioned Wall 16 serves now as inner face to Wall 31. Where Wall 16 ends, a thin face of fairly large rubble of sandstone and conglomerate produces it to the length. The exterior face, somewhat damaged, is built of cyclopean blocks in the centre part. The rest consists of large rubble of equal size and more or less in courses. The core of the wall consists of stones and earth. No mortar is used. Wall 35 covers a section of the edge of the inner face. The wall is bonded into Wall 32, and abuts on Wall 15.

Wall 32.

Height 1.05. Width 1.15.

The extreme west of the wall breaks off at the edge of the rock, but the rest of the wall is well preserved. It is founded on the rock. The material is sandstone rubble of medium and large size as facing stones, laid in more or less regular courses, and small stones and earth in the middle. At the E. end near the angle with Wall 31, the construction is different: the sizes of the stones grow larger, and only a few small chips are wedged-in between them, and the alternation between the two techniques is marked by a clear division. The real angle construction is much damaged, and a large, square block of dressed poros, measuring $1.60 \times 1.05 \times 0.60$ m., was found down the hill-side. It corresponds roughly with the dimensions of the corner-blocks of Walls 1 and 2 (cf. above pp. 374 and 375), and belongs to this angle, which can thus be reconstructed in accordance with those above-described. The wall is bonded into Wall 31, and abuts on Wall 33 A.

Wall 33.

Height 1.20. Width 1.00.

The material and construction is of the same type as in the main part of Wall 32. It is founded on the rock, and overlies the S. edge of Wall 23. The base is broader than the top,

and the wall is regularly stepped back some inches for each course of stones. No mortar is used. The wall abuts on Walls 33 A and 40.

W a l l 33 A. Height 1.10. Width 0.55.

The wall is founded on the rock and built of medium-sized sandstone rubble without mortar. A certain order is kept in the faces, so that the stones are laid in more or less horizontal courses. The wall abuts on Walls 32 and 33.

W a l l 34. Height 0.75. Width 0.85.

The wall is founded partly on a floor, partly on the edge of Wall 31. It is built of medium-sized sandstone rubble without mortar. The facing stones are, as usual, larger than the stones in the core. Its western extremity continues in a low threshold consisting of one course of stones laid on the above-mentioned floor. The wall is bonded into Wall 35. The joint between this wall and Wall 36 is uncertain.

W a l l 35. Height 0.90. Width 0.60.

The wall is built upon the edge of Wall 31, and is of the same construction and material as Wall 34. It is bonded into Walls 34 and 37.

W a l l 36. Height 0.35. Width 0.35.

This wall consists only of a simple row of small stones laid on a floor. No mortar is used. Its connection with the neighbouring Walls 37 and 34 is uncertain.

W a l l 37. Height 0.85. Width 0.65.

The wall is founded on the same floor as Wall 34, and is of the same material and construction as it. Its eastern edge rests partly on top of Wall 31. The wall is bonded into Wall 38.

W a l l 38. Height 1.10. Width 1.05.

The N. end of the wall is damaged and peters out in Wall 17 on which it is founded. The rest of the wall rests on the above-mentioned floor, and is built partly on top of, and partly beside Wall 17. The material is local sandstone rubble built without mortar. Some pieces of conglomerate are occasionally used. The wall is bonded into Walls 37 and 39.

W a l l 39. Height 1.10. Width 0.70.

This wall is founded on the same level, as those previously described, where it is not built on top of Walls 17 and 18. Structure and material are the same as those of Wall 37. The wall is bonded into Wall 38.

W a l l 40. Height 0.60. Width 0.95.

The wall is built in the eastern prolongation of Wall 33, but rests on a layer of debris. It is built of sandstone rubble without mortar. The edging stones are slightly larger than those found in the core of the wall, which also contains some earth-filling and stone chips. The wall abuts on Walls 31 and 33.

CLASSIFICATION OF THE WALLS

The detailed description given in the previous pages, can be used as basis for a classification of the walls into several large groups. Such a classification should only be made with due consideration to structural points, apart from the different levels on which the walls happen to be founded; thus only, can an unassailable and objective survey of the development of architectural technique be obtained. This classification serves also as a summary of the Description of the Walls.

Type 1 is characterized by medium-sized sandstone rubble without mortar. The stones are not laid in distinct courses. The group comprises Walls 6—11, 15—18, 20, 23, 25—27, 30, 34—35, 37, and 39—40.

Type 2. Broad shell-walls of cyclopean, large, or medium-sized sandstone rubble without mortar. The stones are laid in courses, and the angles are built of ashlar masonry. To this group belong Walls 1—3, 14, 19, and 20 A.

Type 3. Narrow shell-walls of large and medium-sized sandstone rubble mixed with pieces of conglomerate, and bound with abundant mud-mortar. The ends of the walls are built of ashlar blocks. The rubble is not laid in courses. The group consists of Walls 4, 5, and 13.

Type 4. These walls are built of sandstone rubble and pieces of conglomerate of large and medium size. No mortar is used, but the stones are laid in distinct courses. The group comprises Walls 12 and 21—22.

Type 5. Broad shell-walls of medium and large sandstone rubble without mortar. The stones are not laid in separate courses. The group comprises Walls 24 and 31.

Type 6. Walls built of medium-sized sandstone rubble, with or without the addition of a few pieces of conglomerate. Mortar is used, but in small quantities, and the stones are kept in separate courses. To the group belong Walls 28 and 29.

Type 7. Walls built of sandstone rubble of medium and large size without mortar, but with courses in the walls. One of the walls (No. 32) can be reconstructed with an ashlar angle. To the group belong Walls 32—33 and 33 A.

Type 8. The material is sandstone rubble and conglomerate of medium size without mortar. The wall is built without courses. The group is only represented by Wall 38.

Type 9. The wall is built of small sandstone rubble without mortar. The stones are not laid in courses. This group also consists only of one wall, Wall 36.

STRATIFICATION

When the excavation of the Fortress began, two main trenches, 2.00 m. broad, were dug across the area, one running N. W. to N., and the other crossing the first at right angles. These were cut down to the natural rock throughout their total lengths. A shallow trench,

parallel to the second main trench was extended further to the N. It was only sunk to the latest floor-level, as revealed in the other trenches. The entrance of the Fortress was excavated in two halves, along its longitudinal axis so that the remaining central earth wall could be studied. Another section was cut through the architectural remains in the N. part of the Fortress. Finally, two details are presented in profile: — viz. a cistern and the remains of a staircase. The sections are described below.

SECTION I (PLAN XV, 2)

The section starts outside Wall 32, and runs to the exterior face of Wall 2. The surface layer is the same over the whole area, and consists of dark-brown earth, mixed with some stones and containing roots of bushes and plants. The section first crosses Walls 32 and 33: — the filling between these walls consists of gravel and rocky material without any floor-level. Wall 32 is founded on the rock, and the N. face of Wall 33 rests partly on Wall 23: the latter rests on earth. At the level of its first course of stones, lies a floor, (Layer 2), consisting of pebbles, packed in hard-trodden rocky matter, and extending to Square F 4 of the section: the level of the floor sinks gradually to this point where it ends. It is covered by a layer of clay containing varying quantities of stones (Layer 1). Close to Walls 33 and 23 the stones are very frequent. The thickness of Layer 1 varies from c. 0.80 m. to c. 0.40 m., and the direct contact with the floor is kept up to Square E 4 of the section. As the floor sinks, another layer of similar consistence is formed below the above-mentioned clay layer (Layer 3), and extends to the middle of Square F 4. Below the floor is a thin layer of debris. It consists of finely pulverized earth mixed with some ash and clayey matter, emanating from decomposed mud-bricks (Layer 4).

In Square H 4 the section crosses Wall 8 which is founded on the rock, and on top of which Wall 30 is built. The stratification will be most conveniently described by beginning close to the walls and working backwards to Square F 4, where we left off in the previous paragraph. Wall 30 is covered by a layer of decomposed mud-bricks mixed with stone fallen from the walls (Layer 1). From Wall 30 a floor layer starts (Layer 2) composed of large pebbles imbedded in rocky matter. It runs horizontally from the wall to Square F 4 of the section, and rests, for almost its total extent, on a layer of sterile, green clay (Layer 3). It rises abruptly at Square F 4 and tapers gradually towards the wall. This part of the layer rests on a sloping ramp of reddish clay and white rocky matter, set with large pebbles (Layers 4 and 5). The highest part of the ramp coincides in level with the top of Wall 8, and lies close against it. Below these strata, and accumulated against Wall 8 is a thick layer of dry, finely pulverized, grey earth containing streaks of ash and many potsherds (Layer 6), which rests upon a floor of local sandstone chips (Layer 7). The floor lies close up to Wall 8. Between the rock and the floor is a thin layer of reddish earth containing a few potsherds (Layer 8). Close to the wall is a pocket of loose earth of different colour, containing mostly small chips of stone; it is evidently a foundation trench.

Between the Walls 8 30 and Wall 20 the filling consists of the following layers: —

1. A layer of clayey earth, mostly emanating from decomposed mud-bricks. It starts at the top of Wall 20 and sinks gradually towards Wall 30, which it covers. It is identical and continuous with Layer 1 mentioned in the previous paragraph.

2. A horizontal floor stratum of pebbles and reddish clay, lying close against Walls 20 and 30.

3. A thick layer of mixed debris containing rubble, rocky matter, clay, and some carbonized matters.

4. A floor stratum of pebbles and rocky matter, lying close against Walls 8 and 20.

5. A layer similar to Layer 3.

6. Finely pulverized clay containing ash and many potsherds.

7. A hard-trodden floor of white rocky matter.

8. A thin bottom layer of decomposed rock.

The three Layers 6—8 are cut through close to Walls 8 and 20 by two foundation trenches. The floor (Layer 4) is laid over these.

Proceeding on the other side of Wall 20 the section crosses Walls 6, 21. Wall 6 is founded on the rock and the filling between Wall 20 and Walls 6, 21 is stratified in similar order to that observed in the previous part of the section. Thus, we have the following layers, counting from the top: —

1. A layer of mixed debris containing rubble, clay, and rocky matter.

2. A thin floor of pebbles and reddish clay. It lies up against the upper part of Wall 20 and on a level with the top of Wall 6.

3. A layer of mud-brick debris and stones.

4. A floor of pebbles and rocky matter lying close up to Wall 6.

5. A thick layer of mixed debris containing many chips of sandstone. It is somewhat obliquely stratified.

6. A layer of culture earth, containing ash, carbonized matter, and many potsherds. The rock slopes from the foot of Wall 6 towards Wall 20, and the layer starts at the highest point of the rock, near Wall 6. Its upper level runs horizontally, so that the layer reaches its maximum thickness close to Wall 20. There it is cut through by a foundation trench similar to that on the opposite side of the wall, and the debris of Layer 5 fills the trench.

The last part of the section lies between the Walls 6, 21 and Walls 2, 24. It consists of two layers of mud-brick debris, frequently mixed with rubble fallen from the walls (Layers 1 and 2). These rest upon a floor of reddish clay and gravel (Layer 3) which runs roughly horizontally from the lowest course of Wall 21, almost up to Wall 2 where it is destroyed by the masses of fallen stones from the wall. Below the floor is a thick layer of rocky matter and chips of sandstone (Layer 4), which reaches down to the rock close to the foot of Wall 24, where it forms a wide foundation trench. At this point the foundation trench cuts through Layers 5—8; Layer 6 forms a thin stratum of culture earth lying between the two floors (Layer 6 and 7) of pebbles and white rocky matter. The bottom stratum (Layer 8) consists of a thick layer of filling material such as rocky matter, chips of stone, sterile reddish clay, and stones.

SECTION II (PLAN XV, 2)

The section first crosses the massive remains of the Walls 14, 31, and 16. Between these walls, and Wall 17 the filling consists of the following layers, except for the surface layer which is the same as in Section I.

1. A wedge-shaped layer of reddish debris containing remains of decomposed mud-bricks.
2. A layer of similar consistency, but of grey colour.
3. A floor layer of small pebbles and white rocky matter lying close up to Walls 16 and 17.
- 4—6. Three thick, almost sterile layers of rocky matter of horizontal, or slightly oblique stratification.

On the other side of Wall 17 starts a floor stratum (Layer 3) of large pebbles pressed into a layer of hard-trodden clay: it runs horizontally, and as the level of the natural rock rises, the floor peters out on the rock. It is covered by two layers of sandy clay mixed with varying quantities of stones (Layers 1—2). The first we have met in the first part of Section I, with the same figure.

Close to Wall 17, where the rock lies at a much lower level, the space between the floor and the rock is filled with two thick layers of rocky matter (Layers 4 and 5), and a layer of decomposed mud-brick (Layer 6), met with in Section I as Layer 4 in Square E 4.

After the floor peters out on the rock the stratification is very simple: Layer 2 vanishes also, with the gradual rise of the rock, and the last half of the section consists only of Layer 1 resting on the rock and covered by the surface layer. The small cavities and irregularities of the rock are filled with sterile rocky matter.

SECTION III (PLAN XV, 2)

This section was cut when the excavation was brought to an end, and serves only to illustrate, diagrammatically, the different levels of the walls. These levels can also be studied by means of the height indices on the main plan. The section runs roughly parallel with Section II through the northern area of the Fortress. The walls crossed by the section are, from left to right Nos. 3, 5, 25, 27, 28, 22, 29, and 24. The rock is laid bare in all parts of the section except for the space between Walls 5 and 27, where the excavation is cut down to the lower floor-level, corresponding with Layer 6 in the last part of Section I.

SECTION IV (PLAN XVI, 1)

This section lies between the Walls 4 and 13. It starts outside a line marked by the exterior faces of Walls 3 and 14 and goes right up to the E. face of Wall 5.

Between the megaliths of Walls 4 and 13 is a deep pit dug by treasure hunters in modern times. It is dug down to a floor, or threshold of flat slabs, laid horizontally, and covering the space between the two walls; the slabs continue as a distinct floor from this point right



Fig. 150. Nitovikla. The cistern.

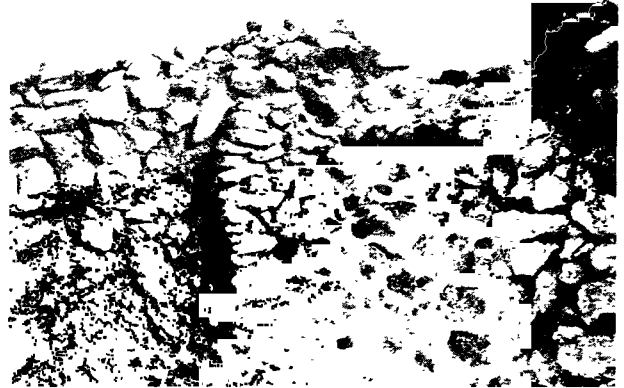

Fig. 151. Nitovikla. The angle between Walls 6/21 and 22, showing the buttress of Wall 6 covered by Wall 22.

up to Wall 5. To the left of the pit, i. e., outside the line of the exterior faces of Walls 3 and 14, the section cuts through the following layers: —

1. Earth thrown up from the pit dug in modern times.
2. The original surface layer, consisting of dark earth mixed with roots and stones.
3. A thick, sloping layer of slightly silted, grey clay.
4. A layer of dark-grey clay, containing small chips of white limestone and pulverized rocky matter.
5. A small sloping layer of pure clay.
6. A horizontal layer of reddish earth.

On the other side of the pit the stratification corresponds closely to the above, but here Layers 3 and 4 are separated by a bluish layer of ash and carbonized matter mixed with silted clay.

SECTION V (PLAN XVI, 1)

This section was cut during the excavation of a cistern, situated in the room enclosed by the Walls 13, 14, and 15. The narrow space within the cistern and the loose nature of the filling, did not permit a partial excavation combined with a detailed study of the remaining earth face, but as the gradual emptying of the well was carefully followed step by step, the stratification given on the drawing can, on the whole, be considered as a reliable diagram of the state of the filling, when excavated.

The construction of the cistern is remarkable. Its mouth consists of a circular monolith, measuring about 1.50 m. in diameter and about 0.25 m. in thickness, and pierced by a central hole of about 0.50 m. diameter; it rests upon the rubble masonry, which lines the interior of the cistern down to a depth of 2.40 m. This masonry again, rests on a rock-cut ledge and serves only as a structure to strengthen the upper part of the natural rock, and to prevent the cistern from collapsing. The lower part of the cistern is rock-cut, without any masonry lining, and here the rock is partly destroyed, giving an irregular shape to that

part of the cistern: originally, the shape was that of an elongated, truncated cone. The total depth is 7.40 m.; the upper diameter 0.51 m. and the bottom diameter 1.12 m. The mouth was filled with clay emanating from decomposed mud-bricks and thereafter followed a thick layer of finely pulverized matter mixed with several large stones. The destroyed section contained rocky matter, and the thick bottom layer consisted of sand and fine earth. The bottom was paved with sherds of thick pithos ware.

SECTION VI (PLAN XVI, I)

This section runs from Wall 8 A to Wall 10, parallel with Wall 8 B. Its only aim is to demonstrate how the top of Wall 8 A lay on a level with the later floor, and how access to the lower level beside Wall 10, was arranged by means of steps. The steps were only shown in the section by different coloured earths, and may have been framed with wooden planks.

ARCHITECTURAL ANALYSIS AND RELATIVE CHRONOLOGY

In the previous paragraphs, the building has been described in detail, and the masses of earth that covered it, have been studied and recorded on the sections. The next step in the interpretation of the building must be an attempt to combine these two elements — the architectural and the stratigraphical — and to elucidate their relationship. The building must therefore be analysed from the point of view of relative chronology, i. e., the different building periods, if any, must be decided upon, and the walls, floors, and other architectural features allotted to their correct places.

From a methodical point of view, a main principle, followed throughout this analysis, must be explained: —

The synchronisation of two walls is proved when they are bonded into each other, but, on the other hand, the lack of proper bonding does not prove that two walls belong to different periods. Primitive technique and crude material does not always make a real bond necessary for two adjoining and contemporary walls. These technical deficiencies are, in the first case due to the fact that the walls are mainly built of rubble masonry: in ashlar work, the lack of bond would have been more conclusive evidence. —

We now proceed to the analysis.

In Squares H—K 4 of Section I, the rock is covered by some layers of earth which all are cut through by the foundations of the Walls 8, 20, and 6. These layers are No. 8 to the south of Wall 8, Nos. 6—8 between Walls 8 and 20, and No. 6 between Walls 20 and 6, and are, consequently, earlier than the walls. No architectural remains can be ascribed to the layers in question, and they were only found in this part of the excavated area, where they have been preserved thanks to the presence of an oblong cavity in the natural rock, visible in Section I. Between Walls 8 and 20, these layers consist of a floor (Layer 7), resting on a levelled stratum (Layer 8), and covered by a layer of culture earth (Layer 6),

and are, therefore, an intact fragment of a house, or courtyard, existing on the site before the above mentioned walls were built. These are the remains of the oldest settlement of Nitovikla, and are dated by the contents of Layers 6 and 7.

In analysing the walls, it is convenient to divide them into different structural units, held together by the obvious synchrony of their respective parts; after which, the interrelations of the groups can be investigated.

- A. Walls 1, 2, 3, and 4 are bonded into one another, and are therefore contemporaneous, thus forming such a structural unit.
 - B. Walls 6, 7, 8, 8 A, and 8 B are held together by reciprocal bonds, and form another unit of the same kind.
 - C. Walls 13, 14, 15, 16, 17, 17 A, and 18 form a similar unit, as they have a coherent chain of bonds.
 - D. Walls 20, 20 A, 10, and 11 are also a structural unit, for similar reasons.
 - E. Walls 21 and 22 are bonded into each other, and can, consequently, be considered as a structural unit.
 - F. Walls 24, 25, 26, 27, and 28 are all reciprocally bonded into each other, and thus form another unit.
 - G. Walls 31 and 32 are held together by mutual, structural bonds.
 - H. Walls 34, 35, 37, 38, and 39, form a similar unit as they are all bonded into each other.
- Walls standing structurally free, and bonded into no other wall, are Walls 5, 7 A, 9, 9 A, 12, 19, 23, 29, 30, 33, 33 A, 36, and 40.

Wall 31 is partly built over the top of Wall 14, and covers a section of Wall 16: consequently, Unit G to which Wall 31 belongs, is later than the Unit C which comprises Walls 14 and 16.

Wall 35 is founded on the edge of Wall 31, whereby it is evident that Unit H is later than Unit G.

The N. edge of Wall 32 covers Wall 19; the latter is, consequently, earlier, and apparently, contemporary with Unit C.

Wall 23 is, at its N. extremity, built on top of Wall 18, but, at the opposite end, covered by Wall 33. This shows that Wall 23 is later than the whole of Unit C, comprising Wall 18, but earlier than Wall 33. The filling between Walls 32 and 33, revealed in Section I, shows that the two walls are contemporary. Wall 33 is, therefore, contemporary with Unit G.

Wall 40 is built against Walls 31 and 33, and is founded on a higher level: it is, therefore, later than Unit G, and, evidently, contemporary with Unit H.

From this part of our analysis we can already assume that we have to deal with four building periods: —

The first is represented by Unit C and Wall 19, which are earlier than Unit G and Wall 33. The second comprises only Wall 23 which is later than Unit C, but

earlier than Wall 33 and Unit G. To the third, belong the Unit G and Wall 33 which are earlier than Unit H and Wall 40, which form the fourth period.

Turning to another part of the excavated area, we see that Wall 24 is built in a foundation trench (see Section I) against Wall 2. Consequently, Wall 24 with Unit F is later than Wall 2 and Unit A.

Wall 21 is built on top of Wall 6: therefore, Unit B, to which Wall 6 belongs, is earlier than Unit E, which comprises Walls 21 and 22.

Wall 22 is partly covered by Wall 24, and, therefore, Unit E is earlier than Unit F.

Wall 30 is founded on Wall 8, and is, consequently, later than Unit B.

The whole of Unit D stands in no immediate structural relation to any other walls, and to determine its position in the scheme of relative chronology, we have to consult Section I. There it is shown that Wall 20 is founded in a narrow foundation trench, dug from the same level as that foundation trench in which Wall 8 is built. This is evidence for their synchrony, and consequently, Unit D is contemporary with Unit B, but earlier than Unit E, which, in its turn, is earlier than Unit F. This means, expressed shortly, that we can trace three different building periods in this section of the excavated area.

Let us now try to combine these results with the stratigraphical evidence, and, by this means, attempt to correlate the units, the chronological relations of which have been dealt with here.

The floor belonging to Wall 8 is shown in Section I by Layer 7 on the S. side of the wall (see above p. 385). This floor peters out on the rock and corresponds to Layer 3 of Section II. This layer also represents a floor which lies against Wall 17, and to which it belongs (see above p. 386). Thus, it is evident that Wall 17 and Wall 8 are contemporary, and the two Units C and B are parts of the same large group.

We have shown above, that Units D and B are contemporary because of the coincidence of the level, in which their foundation trenches are dug. This synchronisation is still further emphasized by their common floor (Layer 4 of Section I between Walls 8 and 20). Another floor, in the N. extremity of Section I shown as Layer 7, helps us to combine Walls 6 and 2. It is true that the floor is cut through by a foundation trench, dug when Wall 24 was erected against Wall 2, but at a distance of about 4.0 m. from the section towards the W. the floor is unbroken and lies close to the two walls. This can also, to a certain extent, be seen in Section III in the area between Walls 25 and 27: the level there shown, represents the floor in question.

Thus, the four units, called A, B, C, and D are all part of one single group of contemporary walls which are the oldest architectural remains in the excavated area, and they are called Group I.

The Units F and G with Wall 33 are both later than Group I: Unit E is, however, earlier than F (see above), and Wall 23 is also earlier than Unit G with Wall 33.

We have shown that Unit E and Wall 23 are later than Group I: from these premises we can, therefore, conclude that Unit E and Wall 23 should be placed between Group I and Units F and G with Wall 33, in a chronological sequence. This being so, it is reasonable

to suppose that Unit E and Wall 23 are contemporary, and that Units F and G with Wall 33 are also contemporary. The former can thus be comprised in one group, called Group II, and the latter in another, called Group III.

Unit H and Wall 40 were later than G with Wall 33 (see above p. 390). Consequently, they must be later than the whole of Group III, and form a group by themselves, called Group IV.

There still remain a few walls which have not yet been ascribed to any of these groups: they are Walls 5, 7 A, 9, 9 A, 12, 29, 30, 33 A, and 36. A glance at the plan shows that Wall 36 must belong to Group IV: it is aligned with the walls of this group and is surrounded by them; moreover, it is founded on the same level. Wall 33 A was surrounded by the same intact filling as that found in Section I between Walls 33 and 32 (see p. 284), and it cannot, therefore, be later than these walls. The top of the wall lies on a level with the two surrounding walls, and it is at right angles to these walls; thus, it cannot be earlier than they. Therefore, its synchronisation with Walls 32 and 33 is proved, and it can be ascribed to Group III.

In the other part of the excavated area, the remaining walls are more difficult to ascribe to the different groups. Starting with Wall 5 the following should be noticed: — Wall 21 abuts on Wall 5, and is, at its western extremity, founded on debris accumulated against Wall 5. It must therefore be later than this wall. Wall 21 belongs to Group II, and Wall 5 can, therefore, be ascribed to Group I, in spite of its lack of bond with Wall 2.

Wall 7 A is earlier than Wall 30, and is surrounded by walls of Group I. This is a good reason for assigning it to that group.

Wall 9 is founded on the rock and aligned with Wall 8 B: similarly to this wall, it is not built in a foundation trench, and the filling between the two walls consists of gradually accumulated rubbish, lying up against both walls. The walls are, therefore, contemporary and Wall 9 belongs to Group I.

Wall 9 A is a prolongation of Wall 9, but it is founded on debris and without an actual bond with Wall 9. It is, consequently, later, and must be ascribed to one of the three later groups. Reasons will be given later on for placing it in Group III (see p. 401).

The same can be said of Wall 30, of which we know nothing, except that it is later than Group I (cf. above p. 390).

Wall 29 abuts both on Wall 24 and on Wall 21. It is, consequently, contemporary with, or later than Wall 21, i. e., Group II, and I place it, preliminarily, in Group III, reserving the matter for later discussion (p. 401).

Finally there remains Wall 12. It is fragmentary, founded on the rock, and covered by layers through which no foundation trenches are dug. It is aligned in right angles to Wall 11, belonging to Group I: thanks to this concurring stratigraphical and structural evidence, it can be assigned to Group I.

The analysis, however, cannot be considered completed, before the layers are also ascribed to these different periods. They have, hitherto, only come into consideration to the



Fig. 152. Nitovikla. The Fortress seen from the North.

limited extent necessary for securing the proper ascription of the walls. We return therefore to the sections, to study them from the analytical point of view.

As already pointed out, Section I reveals some layers earlier than the first building period (see above p. 388): further we have stated that Layer 7 of Section I to the S. of Wall 8, which is identical with Layer 4 of Section II, is the main floor of the first building period (see above p. 398): Layer 2 in the same part of Section I is another floor which goes right up to Wall 30. It must be later than Layers 4 and 5, which are a sloping ramp piled up against Wall 8. The floor of this wall is Layer 7, dating from the first building period. Layers 2 and 4—5 are consequently floors belonging to later periods. As Layer 2 is the main floor of the central court, it cannot reasonably have been constructed during the fourth period, which is characterized only by some small restorations at the opposite part of the Fortress (cf. below). Consequently, Layer 2 ought to be dated to the third, and Layers 4—5 to the second building period. As Wall 30 is connected with Layer 2, and the ramp (Layers 4—5) with Wall 8, it must be presumed that Wall 30 belongs to the third period (Group III). Layer 6, which is below the floor of the second period (Layers 4—5) belongs to the first period. The almost sterile filling of green clay (Layer 3) must be assigned to the transition from the second to the third period as it fills the interstice between their floors.

In Square F 4 of Section I, the floor of the third period sinks abruptly and the floor of the first period has served both the second and third periods. Wall 23 rests on this floor, which is laid upon a thin layer of finely pulverized earth, mixed with ash (Layer 4), which must be ascribed to an epoch earlier than the first building period. Layer 1 in this part of the section is, therefore, to be attributed to the third period. The filling between Walls 32 and 33 is, of course, contemporary with the walls, and is thereby dated to the third period.

Now we will turn to the other end of the section. Layer 7 between the Walls 6/21 and 2, 24 is the floor of the first building period, as it goes right up to Wall 6 and is cut through by the foundation trench beside Wall 24 (cf. above p. 385). The culture stratum accumulated on the floor (Layer 6) belongs, consequently, to this period. Layer 8 is a stratum of artificial filling, spread below the floor, to level the ground. The floor on top of Layer 6 must be ascribed to the second building period: it is cut through, in the same way as other layers, by Layer 4 which is a similar filling to Layer 8, and serves as a substructure for the third floor (Layer 3). This floor and the two covering layers (Layers 1—2) mark the third building period.

Between Walls 8/30 and 20, and 20 and 6/21 the distribution of the layers among different periods is easy. Layer 2 is the floor of the third building period, and Layer 4 that of the first. The latter has, apparently, been used in the second, too. Layer 5 between Walls 20 and 6/21 is an obliquely stratified, artificial filling, supporting the floor of the first building period. The rest of the stratification has already been dealt with (see above p. 388).

In the main part of Section II there is only one floor stratum (Layer 4) covered by three thin layers of accumulated earth and debris: it has evidently been in permanent use during all the building periods, and it is supported by Layers 5 and 6 beside Wall 17. A similar stratification can be seen in the part of the section between the Walls 17 and 16, where Layer 3 is the common floor-level, supported by Layers 4—6 and covered by the debris of Layers 1 and 2.

Section IV also shows only one floor-level, the pavement at the bottom of the section. The rest of the strata are accumulated debris, emanating from the final destruction of the building.

The walls of the fourth building period are not crossed by any sections; they were all founded on the floor-level, common to the three earlier building periods, and this floor was again used during the last period.

The stratigraphical and the architectural evidence show that the two building periods, called above the second and the fourth, are of considerably less importance and extent than the first and the third. It seems therefore more correct to consider the former as sub-periods of the latter. Our final relative chronology, including the epoch earlier than the first building period, can, therefore, conveniently be compressed into the following outline: —

- I. Pre-Fortress period
- II. First building period
 - A) Walls 1—20 A, except Wall 9 A
 - B) Walls 21—23
- III. Second building period
 - A) Walls 24—33, and Wall 9 A
 - B) Walls 34—40.

ARCHITECTURAL SYNTHESIS

The next stage of our investigation will be an attempt to build up a comprehensive view of the architecture of each period. This must be examined from the points of view of form and plan and of architectural technique, especially with regard to the classification of the walls.

It is a matter of course, that this point of view cannot be applied on Period I. i. e., the so called pre-Fortress epoch. Everything that can be said about it, is already mentioned in the analytical chapter. The layers in question are tiny remains of a humble settlement, which occupied the hillock before the building activity of Period II A started. A floor consisting of a simple layer of trodden, white limestone matter, spread on a thin levelling stratum of artificial filling, and covered by a layer of mixed debris, containing much ash were the only remnants. This indicates that the settlement was destroyed by fire.

PERIOD II A

Material and Construction

Comparing the summary given in the Classification of Walls (p. 383) with the walls of this period, we can state that this first architectural period of the fortress is characterized by the occurrence of our Types 2 and 3, i. e., shell-walls with ashlar corners and ends, such as are not found in any of the other building periods. The common Type 1 is frequently represented and one single wall (Wall 12) belongs to Type 4.

Of the mud-brick walls, which must be presumed at various points of the interior architecture, e. g. the S. wall, and the partition walls of the Northern Casemate, the Storehouse, the Kitchen etc., (cf. below) nothing was left except decomposed debris.

The interior floors (cf. Stratification p. 385 ff.) consisted of small pebbles set in a layer of white limestone matter: this forms a very hard-wearing surface. The terrace below the Northern Casemates was paved with the same material, and the courtyard with pebbles of larger size packed together in a bed of grey clay.

The roofs must have been flat and it is very likely that they were of the still common, Cypriote type, with parallel beams set near together, covered by a layer of twigs and sticks, the whole packed by a thick layer of clay.

Special attention must, of course, have been paid to the water supply: the cistern (see p. 387 and Fig. 150) and a large stone jar are the only remains of such arrangements inside the Fortress. In the main fortified area, not far from the entrance of the Fortress was a well, (see above p. 372), which evidently supplied their needs during normal conditions; but during times of siege, the access to the well could be cut off, and the defenders had to fall back upon the supply of the cistern. This was not very large as the cistern only held about 4.5 cubic meters: the water collected was, of course, rain-water and it must have been lead into the cistern by channels from the roofs. It must be kept in mind that the possibility remains of other cisterns having been cut in the rock in the S. W. part of the Fortress, which is now entirely destroyed.



Fig. 153. Nitovikla. The fortress seen from within the main fortified area.

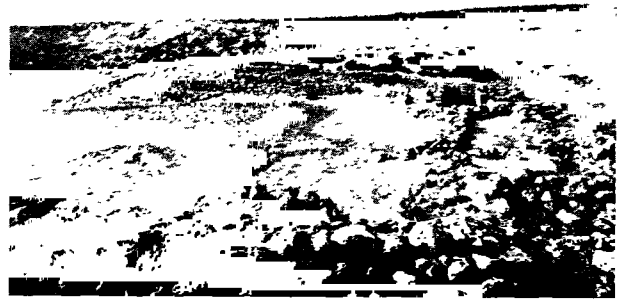

Fig. 154. Nitovikla. The courtyard. In foreground Wall 39.

Form and Plan

The period introduces building activity on a larger scale, and a glance at the plan clearly shows its fortified character: a central area, enclosed by massive ramparts. Another observation can also be made at once: — the W. side of the top plateau is destroyed. This side of the hill is the steepest, and is exposed to the destructive effect of the west winds, and the plateau has been, and is still being gradually undermined by the rapid erosion of the soft sandstone rock. In Section II the considerable overhang can be seen. On the slope below the western edge lay masses of building debris, which proves that we have to reconstruct a system of walls on this side, similar to those on the other sides of the plateau. Wall 1 is a fragment of the flanking wall i. e., the main western rampart on the destroyed, side, and Wall 2 is the northern rampart. Walls 3 and 14 serve as ramparts for the E. side, from which the enclosure could be entered. The southern part of the area lacks exterior walls of this period, except for the tiny fragment, Wall 19, which is a valuable criterion of the extension of the fortress at this epoch. The cause of the almost entire destruction of this side is other, than that of the W. side: here it has not been demolished by natural causes but has, apparently, been purposely pulled down. We shall return to this question, later on.

These large exterior walls enclose an area of an irregular, trapezoid shape — the main courtyard of the fortress (Fig. 154). It is bounded by several walls, the plan of which we must now examine.

Between Wall 6 and Wall 2 we have an extensive, oblong room entered by a door, opening from the narrow corridor between the Walls 5 and 7: the floor lies on the level 99.8. The buttresses of Wall 6 make it very probable, that this long room has been divided into three apartments by walls of perishable material, and that these walls have rested on the solid buttresses of the stone wall. Outside this suite of rooms runs a narrow corridor bounded by Wall 20. Its floor lies on a slightly lower level than the floor of the rooms. Parallel with this corridor lies another very narrow passage bounded by Wall 8, and at the junction of Wall 8 and Wall 8 A, it widens into a trapezoidal room enclosed by the Walls

8 A, 8 B, 10, and 20. The floor of the passage lies in the section at level 97.6; that of the room consists of the natural rock which here rises to level 95.4: that is to say, the floor of the passage sinks westwards until it meets the gradually rising level of the natural rock. In the section, the floor of the courtyard lies on 90.5. The section through these walls and floors thus gives a picture of a terrace in front of a corridor and a suite of rooms. At the W. end of the terrace, is the entrance to a trapezoidal room. The difference in level between the terrace and the courtyard is about 0.80 m., and the floor of the corridor and the suite of rooms along the northern defences — hereafter called the Northern Casemates — are laid on this high level. The corridor was entered by a flight of steps, founded on Wall 7 A. The top of Wall 20 lies here on a considerably lower level (102.7), indicating the threshold, and the gap in Wall 6 shows another entrance to the Northern Casemates. To judge from the type of the floor the corridor was roofed in, but along its whole southern long side it was probably open, thus serving as a sun shelter, but still freely admitting light into the rooms behind. Such an arrangement is still a characteristic feature of Cypriote domestic architecture. The buttresses of Wall 20 show the places of the supporting columns.

The trapezoidal room contained a fireplace on the floor and in the earth covering the floor fragments of animals' bones, charcoals, and quantities of broken pottery were found. It is, therefore, called the Kitchen. East of the hearth was a large stone jar standing *in situ*, and it seems reasonable to suppose, that it was separated from the hearth by a wall of some perishable material. The jar was directly accessible from the courtyard, and has probably served as a tank for drinking water. The Kitchen could be entered, not only from the platform but also by a door in its S. wall (Wall 9); it was divided into two compartments by Wall 8 B, in the S. one of which the hearth was situated: the other may have served as a store-room.

Behind the Kitchen is another trapezoidal room enclosed by Walls 10, 11, 20, and 20 A: it is very badly preserved, as are all architectural remains in this part of the fortress, and parts of its W. and S. walls are entirely demolished and have fallen down the hill-side. The corridor runs along the short side of the room, and it seems probable that it was entered from this side. This arrangement can be compared with the main entrance to the Northern Casemates, to which access was gained from the narrow passage between Walls 5 and 7. The room behind the Kitchen seems to be the only remaining one of a row of casemates similar to the suite along the N. defences. Wall 12 indicates decidedly a continuation of the complex in that direction, but we are left in ignorance as to its definite plan.

The platform in front of the Northern Casemates was about 0.8 m. higher than the floor of the courtyard: it can be seen in Section I that this floor goes right up to Wall 8, and there was, consequently, an abrupt difference in level; a difficulty which must have been overcome by means of some flights of steps built of perishable material. As such arrangements could not be traced in the section, they must have been placed somewhere else along the terrace.



Fig. 155. Nitovikla. The terrace and the corridor in front of the Northern Casemates, seen from the inner gate.



Fig. 156. Nitovikla. The tower and the store-room at the eastern rampart, seen from the inner gate.

The entrance to the fortress was reached by the passage between the Walls 4 and 13; the gate itself was flanked by two megaliths placed upon bases with rustic decorations. To the right of the entrance is a square room, enclosed by the Walls 2, 3, 4, and 5: This room was entered over two thresholds between Walls 4 and 5, and its square plan, isolated situation, and massive exterior walls show that it was a tower. Wall 4 A is, apparently, a base for a wooden staircase leading up to the higher parts of the structure. On the other side of the entrance are the foundations of a similar tower (Walls 13, 14, and 15), and in the corner between Walls 14 and 15 is a square setting of stones, doubtless of the same type and for the same purpose, as Wall 4 A.

To reach the courtyard from the main gate it was necessary to turn to the left, pass a second gate leading into the left-hand tower, and from there the yard finally was accessible. The threshold of the second gate is a large monolith with steps cut in it. In the lefthand tower, also, the above-mentioned water cistern (see above p. 387) is found. —

The main E. rampart (Wall 14) is demolished at its S. extremity. Inside the rampart, are Walls 16, 17, and 17 A. To disentangle the functions of these walls we have to consult Section II. They enclose a narrow space entered by a door at the S. end of Wall 17. Between the walls is a floor, at the same level as the courtyard. This space must, therefore, have been a room under roof, a fact that is likewise proved by the construction of its floor. Its width varies slightly, but does not exceed 2.5 m. Its total length is difficult to fix because of the bad state of preservation of Wall 16, but it was at least 14.0 m. Such a long and narrow room cannot conveniently have been used for anything else but a store-room.

How was the space between Walls 14 and 16 utilised during this period? The question cannot be answered with certainty. Wall 31 belonging to a later epoch now fills the space, and it seems reasonable to suppose that it was used in a way similar to that above-described, i. e., as a store-room. The possibility must, however, be admitted that the two Walls 16 and 14 have served as shells for a core, and that, consequently, the space between them was filled in the same way as in the following Period III A (cf. below p. 402).

The construction of the S. rampart is unknown; as pointed out above, it has been demolished, and the only remaining parts are the two short Walls 18 and 19.

In the middle of the courtyard lies a square base of rubble masonry: in the earth-filling above and around it were found much ash and carbonized matters. As it stands quite free and lacks all structural function, it seems very probable that it was an altar.

To sum up the characteristic features of the first fortress. It was surrounded on all sides by massive ramparts. The entrance was guarded by two towers, and consisted of a covered passage with a right angle turn to the left, and closed by an inner gate. Along the N. side of the courtyard lay the Northern Casemates, a suite of three large rooms with a sun shelter along the façade. In front of these was a platform slightly raised above the courtyard, and reached by short flights of steps. The Kitchen lay in front of the barracks and could be entered either from the platform, or directly from the court. Along the W. rampart there was, apparently, a suite of barracks similar to the Northern Casemates, but only one of the rooms is preserved. The opposite side of the court was flanked by a long storehouse, and in the centre lay the altar.

The height of the ramparts can be reconstructed with a fair amount of accuracy. The reconstruction must start from a fixed point and that we have got in the floor of the Northern Casemates. This floor lies on level 99.8, and the height of the casemates can be reconstructed, at about 3.00 m.: we, thus, reach the level 129.8. Supposing that the roof of the casemates lay flush with the top of the rampart, we must add at least another meter for a parapet, giving the level 139.8: the foot of the rampart lies on the level 81.0 (see Section I), and the difference between these two figures gives the minimum height of the rampart, rather less than six meters. The floor of the store-room inside the E. rampart lies on approximately the same level as the floors of the Northern Casemates (see Section II), and calculating from the same measurements, we obtain the same total height.

The roofs of casemates and store-rooms together with the body of the rampart seem, thus, to have served as a main platform for the defenders, from whence they could throw their weapons into the ranks of the attackers, themselves protected by the parapet. How the soldiers of the garrison reached their places on the ramparts, i. e., by what means they communicated with the roofs of the casemats, or the storehouse, can be explained by the buttresses of Wall 17, and by Wall 17 A. Their purpose remains obscure, unless one supposes that they served as bases for ladders, or wooden staircases leading up to the roofs. The reconstructed sketch shows how the problem can reasonably be solved.

PERIOD II B

M a t e r i a l a n d C o n s t r u c t i o n

In the Classification of Walls (see above p. 383) the walls of this period are characterized as Type 4, with exception of Wall 23, which belongs to the common Type 1.

The epoch is, therefore, mainly characterized by the use of conglomerate as building material, and the method of laying the stones in separate courses in the walls.

Floors and roofs are of the same kind as those of the previous period, and other technical details are also in accordance with Period II A.

Form and Plan

The building activity of this epoch is very scanty. Entrance, ramparts, courtyard, storehouse, Western Casemates, Kitchen, and the terrace in front of the Northern Casemates were the same as in the previous period. Access to the platform in front of the Northern Casemates, from the courtyard, was facilitated by building a sloping ramp lined with large pebbles and reaching right up to the top of Wall 8; this ramp is represented by Layers 4—5 to the south of Wall 8 in Section I. The other alterations are, as far as can be seen, limited to some repairs to the Northern Casemates and the southern rampart, represented by Walls 21—23.

The base of the Northern Casemates were raised by the building of Wall 21: the old entrance to the block was closed by extending the wall right down to Wall 5, and two new doors were opened in the façade, for which the old Wall 6 served as thresholds. Further, one of the supposed partition walls of perishable material was replaced by a wall with stone base (Wall 22), and the other was, apparently, definitely pulled down. The floor of the Casemates was raised about 0.20 m.

At the opposite end of the courtyard, the small wall fragment 23 is a proof that some restorations were carried out here, as well. It is, however, a matter of conjecture to what extent and for what purpose they were made. The uncertainty is due to the destruction, probably due to invaders, of this part of the Fortress at the end of Period II B.

PERIOD III A

Material and Construction

For the technical innovations introduced in this period, I again refer to the Classification of Walls (p. 383). Types 5, 6, and 7 consist exclusively of walls from this period: the broad shell-walls are not provided with ashlar corners; in some of the walls small quantities of mud-mortar are used as binding material, and the stones are laid in distinct courses. The common Type 1 comprises also several of the walls from this epoch.

The floors of the platform and of the new Northern Casemates consist of reddish clay set with chips of stones and small pebbles. The pavement of the court is the same as in the previous periods. This consistency with the technique of the earlier epochs holds good also for the roofs and other details, as far as they could be studied. Thus the old cistern still served as a water-supply, and the stone jar at the back of the Kitchen was probably still accessible.

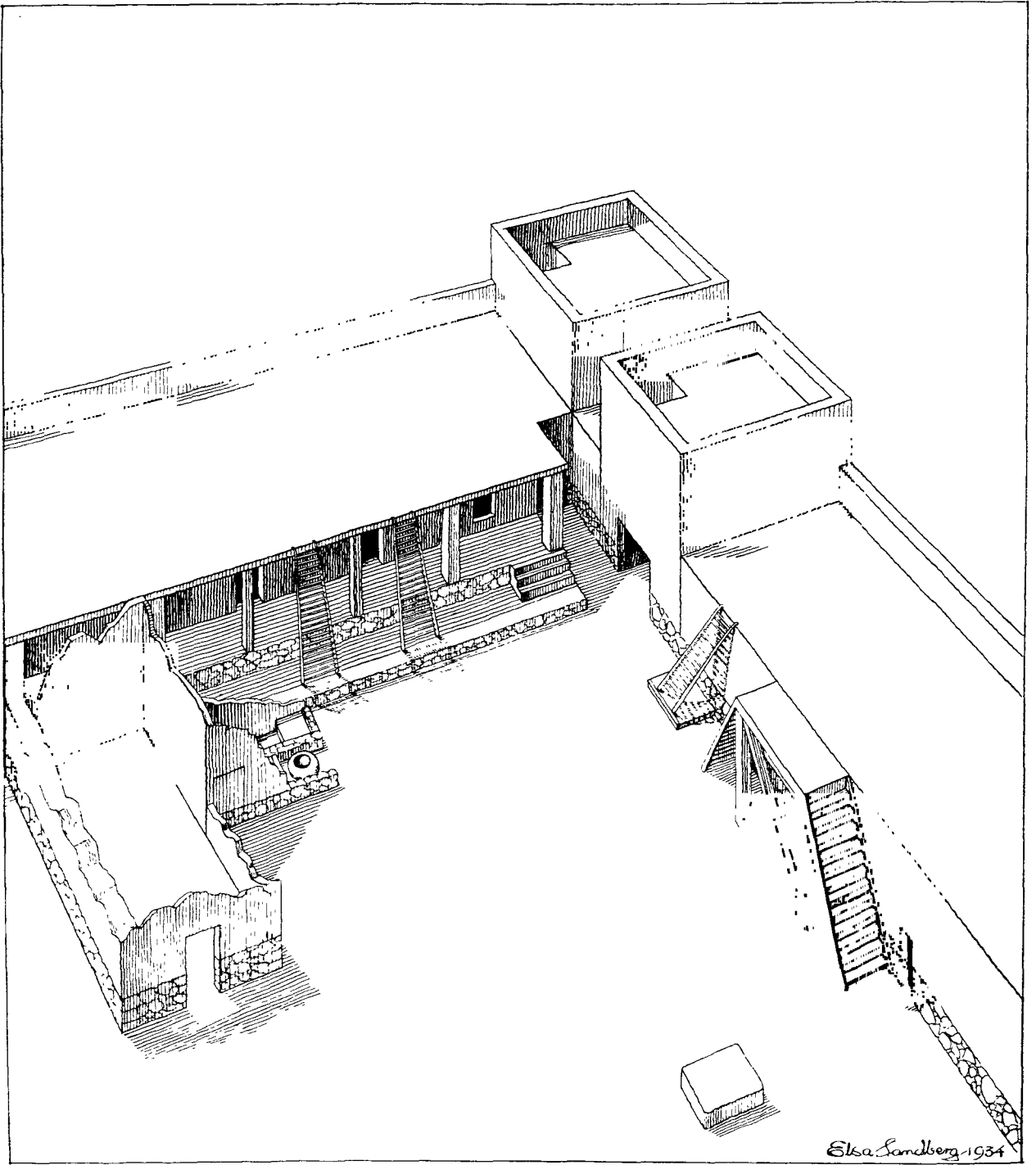

Fig. 157. Nitovikla. Reconstructed sketch, showing the courtyard and surrounding buildings during Period III A.

Form and Plan

After the catastrophe at the end of the previous period the Fortress was repaired and rebuilt without delay, and they stuck to the old plan in all essential details. The entrance and its towers had withstood the general destruction, and therefore kept their old form without any traceable repairs. The Kitchen and the Northern Casemates were very badly damaged, and their debris covered the floors and the platform in front of them (Layers 3 and 4 in the concerned part of Section I). Fire seems to have completed the destruction. We can conveniently start our survey of the restoration from this point. In first place, the debris and the older floors were dug through down to the natural rock along the inner side of the main northern rampart, and Wall 24 was built as a strengthening revetment against Wall 2. It widens considerably towards the West and forms in the angle a square area of the same size and shape as that of the N. entrance tower. It seems reasonable to suppose that it served as the foundations for a third, corresponding tower, but the bad state of preservation makes it difficult to find a definite proof of this hypothesis.

The space, previously occupied by the Northern Casemates, was thus diminished and divided into seven small rooms by partition Walls 25—29. Walls 21 and 22 were re-used, as well as the old doorways. Thus all the new rooms communicated with each other, except for the westernmost one of the suite: this room is very small, and may have had some connection with the supposed W. tower. The floors of the new casemates and the open corridor in front of them were laid on top of the debris, thereby raising the level about 0.90 m.

This rendered necessary a corresponding raising, not only of the northern rampart, but also of the platform in front of the casemates. Wall 20 was raised about 1.00 m., and Wall 30 was based on Wall 8. Wall 30 was built as a prolongation of Wall 8, right through the ruins of the old Kitchen, until it reached the Western Casemates at Wall 10. The floor of the new platform in front of the Northern Casemates can be seen as Layer 2 in the part of Section I concerned.

The whole N. side of the courtyard was also raised by means of artificial filling (Layer 3 in the middle part of Section I) and reset with new stone.

The Kitchen, which had been considerably reduced by the building of the new terrace bounded by Wall 30, was rebuilt at its old level. The S. door into the courtyard was blocked up by Wall 9 A, and the new entrance was made by a door facing E.: the threshold of this door was the old Wall 8 A, the top of which now lay at the same level as the surrounding courtyard, and a flight of two steps lead down to the floor of the Kitchen. This arrangement can be studied in Section VI.

In the fragment of the western rampart and its casemates no traceable repairs were carried out.

The eastern rampart had suffered severely from the siege and the conquest of the Fortress: its entire southern extremity had to be built anew, and it was strengthened

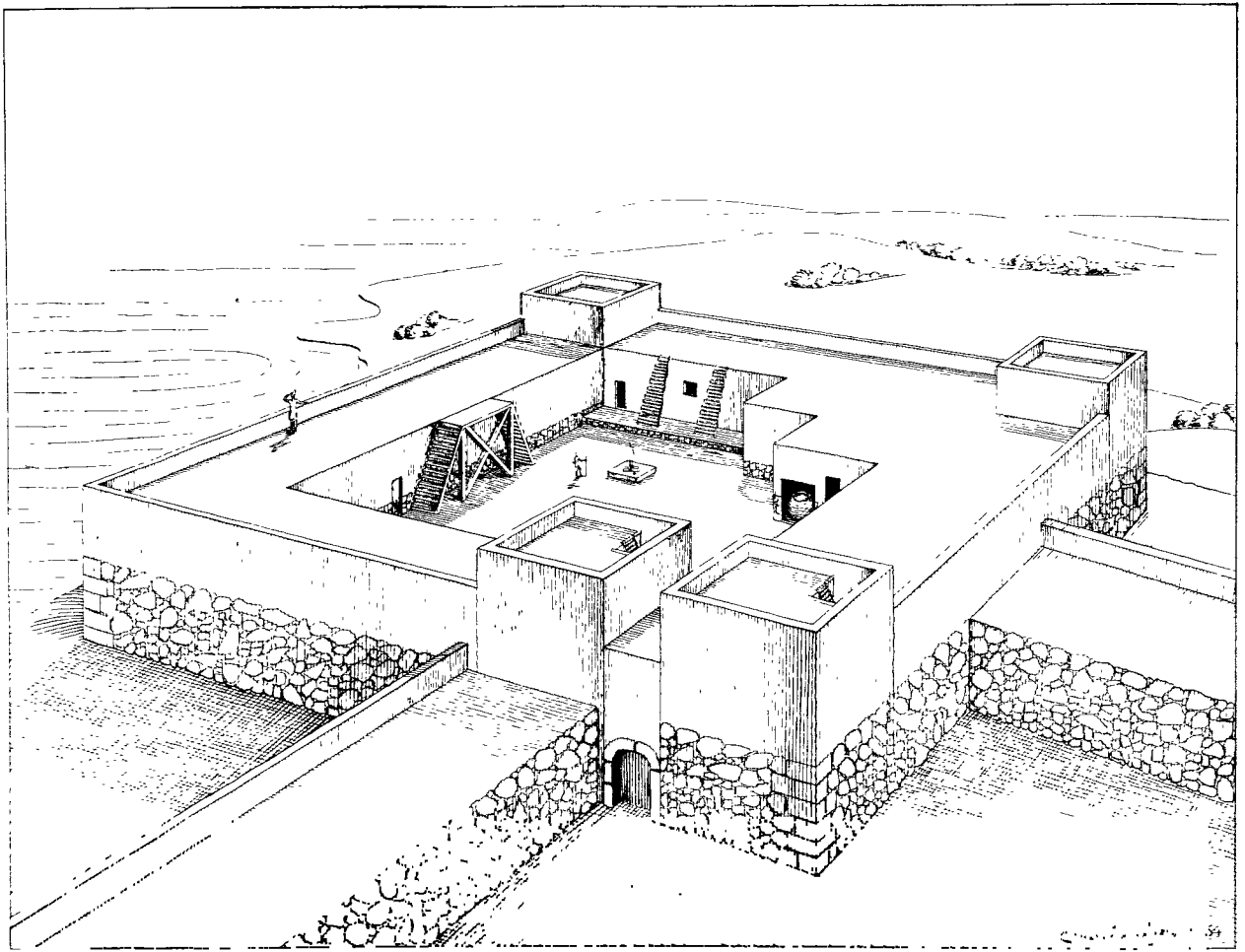

Fig. 153. Nitovikla. Reconstructed sketch, showing a view of the whole Fortress during Period III A.

on the opposite side as well. This was carried out by building Wall 31, which filled the space between Wall 16 and the remaining portion of Wall 14. The storehouse inside the rampart seems to have been rebuilt on the old level and plan: at least, there is no new floor traceable in Section II.

The southern rampart consists of two Walls, 32 and 33. They converge gradually westwards, and the filling between them (see Section I) shows that there was no open space between them where the section crosses. At the eastern extremity, however, the space between the walls, which here reaches its maximum, must have been a room, as it communicates with the western storehouse. Wall 19, dating from Period II A, has, apparently, been used as a base for a partition wall.

Wall 23, dating from Period II B, was still visible above ground, and has probably served the same purpose as Wall 17 A and the buttresses of the Wall 17, i. e., a base for ladders, or wooden staircases leading on to the top of the rampart. The W. extremity of the S. rampart has fallen down the hill-side, which is badly undermined at this point. Therefore a comprehensive view of the fortifications cannot here be obtained.

PERIOD III B

Material and Construction

From the technical point of view, this epoch does not show anything new of interest. The alterations are limited to the walls: the mortar used in the previous period is again abandoned, and the stones are of small size. Types 8 and 9 of the Classification of Walls only comprise walls from this period, and the rest belong to Type 1.

Form and Plan

The building activity of this period is limited to a very small area and does not show any radical alterations in the general plan or appearance of the Fortress. In the S. E. corner of the area there is a small rectangular system of Walls (Walls 34—39) which can be ascribed to this, the very last stage of development of the architecture of the Fortress: by means of them, the main western storehouse is divided into three apartments, two of which communicate with each other: the third seems to be rather isolated, as it is also enclosed by Wall 40. It resembles in plan and situation the room close to the western tower, enclosed by Walls 21, 24, and 29. Wall 39 had probably a similar function to that of Wall 23, i. e., it made access possible to the southern rampart by means of wooden staircases and ladders.

ABSOLUTE CHRONOLOGY

During the whole excavation not a single object was found, except potsherds. For the dating of the different periods of the Fortress we must rely entirely upon the pottery. As is to be expected in a place like this, a very great many of the sherds represent fragments of large pithoi and jars, made of thick Plain White Ware and of Coarse Ware, both hardly possible to analyse from a chronological point of view. It seems, therefore, wiser to omit these undeterminate wares in the forthcoming review of the ceramic material, in order not to upset the proportions of the determinate classes. The very abundant Plain White Wheel-made Ware of thin fabric cannot either conveniently be used as a chronological criterion. It occurs in great masses in all strata, and as the fragments are not large enough to render a reconstruction of the original shapes possible, no typological differences can be discerned: it is therefore also omitted. The three classes of Pithos Ware, Coarse Ware, and Plain White Ware are, therefore, only calculated in approximate percentages in the diagrammatic statistics below. On the whole, the site was poor in potsherds, and only about 125 boxes were collected during the excavation. The selected conclusive material is given below.

TRENCH I

Square C 4, southern part.

108.0—106.0	Pithos Ware etc.	more than 95 %	0
	Monochrome		1
106.0—104.0	Pithos Ware etc.	about 90 %	0
	Black Slip III		2
	White Slip		2
	White Painted Wheel-made		2
104.0—102.0	Pithos Ware etc.	about 90 %	0
	Black Slip III		1
	Red Slip		1
	White Painted Wheel-made		2
	Bichrome Wheel-made		3
102.0—100.0	Pithos Ware etc.	about 60 %	0
	Black Slip II		23
	Black Slip III		8
	Red-on-Black		7
	Red Slip		6
	Black Slip Wheel-made		20
	White Painted Wheel-made		4
	Bichrome Wheel-made		4

Square D 4, southern half.

104.5—102.5	Pithos Ware etc.	more than 95 %	0
	Monochrome		2
	Black Slip Wheel-made		2
	White Painted Wheel-made		9
	Bichrome Wheel-made		1
102.5—100.5	Pithos Ware etc.	more than 90 %	0
	Black Slip II		24
	Red-on-Black		19
	Red Slip		12
	Base-ring		2
	White Slip		2
	Black Slip Wheel-made		26
	Red Slip Wheel-made		6
	White Painted Wheel-made		2
	Bichrome Wheel-made		1
	A piece of flint. Fragments of bones		
100.5—98.7	Pithos Ware etc.	more than 80 %	0
	Black Slip II		21
	Black Slip III		2
	Red-on-Black		6
	Red Slip		12
	White Painted V		1
	Black Slip Wheel-made		21
	Black Lustrous Wheel-made		3
	White Painted Wheel-made		3
	Bichrome Wheel-made		16
	Bones		
98.7—96.7	Plain White Hand-made	about 50 %	0
	Red-on-Black		7
	Red Slip		5
	Bichrome Wheel-made		1

Square D 4, northern half.

104.5—100.5	Pithos Ware etc. only		
100.5—98.5	Pithos Ware etc.	more than 95 %	0
	Monochrome		2
	Base-ring		11
	White Painted Wheel-made		17
	Bichrome Wheel-made		6
98.5—96.5	Pithos Ware etc.	more than 90 %	0
	Black Slip II		11
	Red-on-Black		5
	Monochrome		2
	Base-ring		6
	White Slip		1
	Black Slip Wheel-made		9
	White Painted Wheel-made		14
	Bichrome Wheel-made		5
	Fragments of bones		
96.5—94.5	Pithos Ware etc.	about 50 %	0
	Black Slip II		19
	Red-on-Black		5
	Red Slip		2
	White Painted V		2
	White Slip		1
	Black Slip Wheel-made		15
	Black Lustrous Wheel-made		3

Square E 4, southern part.

104.0—100.0	Pithos Ware etc.	about 95 %	0
	Black Slip Wheel-made		1
	Red Slip Wheel-made		2
	White Painted Wheel-made		1
100.0—98.0	Pithos Ware etc.	more than 95 %	0
	Black Slip II		1
	Base-ring		2
	White Painted Wheel-made		1
	Bichrome Wheel-made		3
98.0—96.0	Pithos Ware etc.	more than 95 %	0
	Monochrome		3
	Base-ring		1
	Black Slip Wheel-made		3
	White Painted Wheel-made		5
	A piece of flint. One tooth.		

Square F 4, northern part.

103.5—99.5	Pithos Ware etc.	more than 95 %	0
	Base-ring		2
99.5—97.5	Pithos Ware etc.	more than 95 %	0
	Bichrome Wheel-made		1
97.5—95.5	Pithos Ware etc.	a few sherds.	

Square G 4, northern part.

103.0—99.0	Pithos Ware etc.	more than 95 %	0
	Red Slip		1
	Black Slip Wheel-made		3
	One spindle-whirl.		

99.0—95.0	Pithos Ware etc. only	
95.0—90.0	Pithos Ware etc. only	
Square H 4.		
101.0—99.2	Pithos Ware etc.	more than 90 %
	Black Slip III	2
	Monochrome	3
	Base-ring	2
	White Slip	1
	Black Slip Wheel-made	7
	Red Slip Wheel-made	2
	White Painted Wheel-made	2
	Bichrome Wheel-made	2
93.0—90.8	Pithos Ware etc.	more than 60 %
	Black Slip II	18
	Red-on-Black	10
	Red-on-Red	2
	Black Slip Wheel-made	15
	Red Slip Wheel-made	10
	White Painted Wheel-made	8
	Bichrome Wheel-made	11
	Bones	
Between Walls 8'30 and 20.		
110.0—106.0	Pithos Ware etc.	more than 95 %
	Monochrome	1
	White Painted Wheel-made	1
106.0—101.5	Pithos Ware etc.	about 60 %
	Black Slip II	9
	Black Slip III	3
	Red-on-Black	3
	Red Slip	2
	Base-ring	2
	White Slip	1
	Black Slip Wheel-made	29
	Red Slip Wheel-made	4
	Bichrome Wheel-made	3
91.0—89.0	Pithos Ware etc.	about 50 %
	Black Slip II	20
	Black Slip III	2
	Red-on-Black	7
	Red Slip	2
	Black Slip Wheel-made	76
	Red Slip Wheel-made	3
	White Painted Wheel-made	4
	Bichrome Wheel-made	4
89.0—87.0	Pithos Ware etc.	about 15 %
	Red Polished IV	4
	Black Slip II	33
	Red-on-Black	34
	Red-on-Red	7
	Red Slip	4
	White Painted IV	1
	Black Slip Wheel-made	55
	Red Slip Wheel-made	12
	White Painted Wheel-made	3
	Bichrome Wheel-made	1

TRENCH II

Between Walls 16 and 17.

105.0—99.0	Pithos Ware etc.	more than 80 %
	Black Slip II	4
	Monochrome	1
	Base-ring	1
	White Slip	1
	Black Slip Wheel-made	7
	Red Slip Wheel-made	2
	White Painted Wheel-made	24
	Bichrome Wheel-made	8
99.0—95.0	Pithos Ware	20
95.0—90.0	Pithos Ware	14
Square E 3.		
103.5—97.5	Pithos Ware etc.	more than 90 %
	Black Slip II	4
	Base-ring	1
	White Slip	1
	Black Slip Wheel-made	2
	White Painted Wheel-made	11
	Bichrome Wheel-made	6
97.5—95.0	Pithos Ware etc.	more than 95 %
	Black Slip Wheel-made	3

THE GATEWAY

97.5	Fragments of a large stirrup-vase of painted Coarse Ware. (Pl. LXX, 5).
92.0—88.0	Pithos Ware etc. more than 95 %
	Black Slip Wheel-made 4

WESTERN CASEMATES

On the floor.

	Pithos Ware etc.	more than 60 %
	Black Slip II	79
	Red-on-Black	6
	Red-on-Red	1
	Red Slip	19
	Monochrome	6
	White Slip	1
	Black Slip Wheel-made	43
	Red Slip Wheel-made	11
	White Painted Wheel-made	15
	Bichrome Wheel-made	14

KITCHEN

On the floor.

	Pithos Ware etc.	more than 90 %
	Black Slip II—III	28
	Red Slip	9
	Monochrome	26
	Base-ring	39

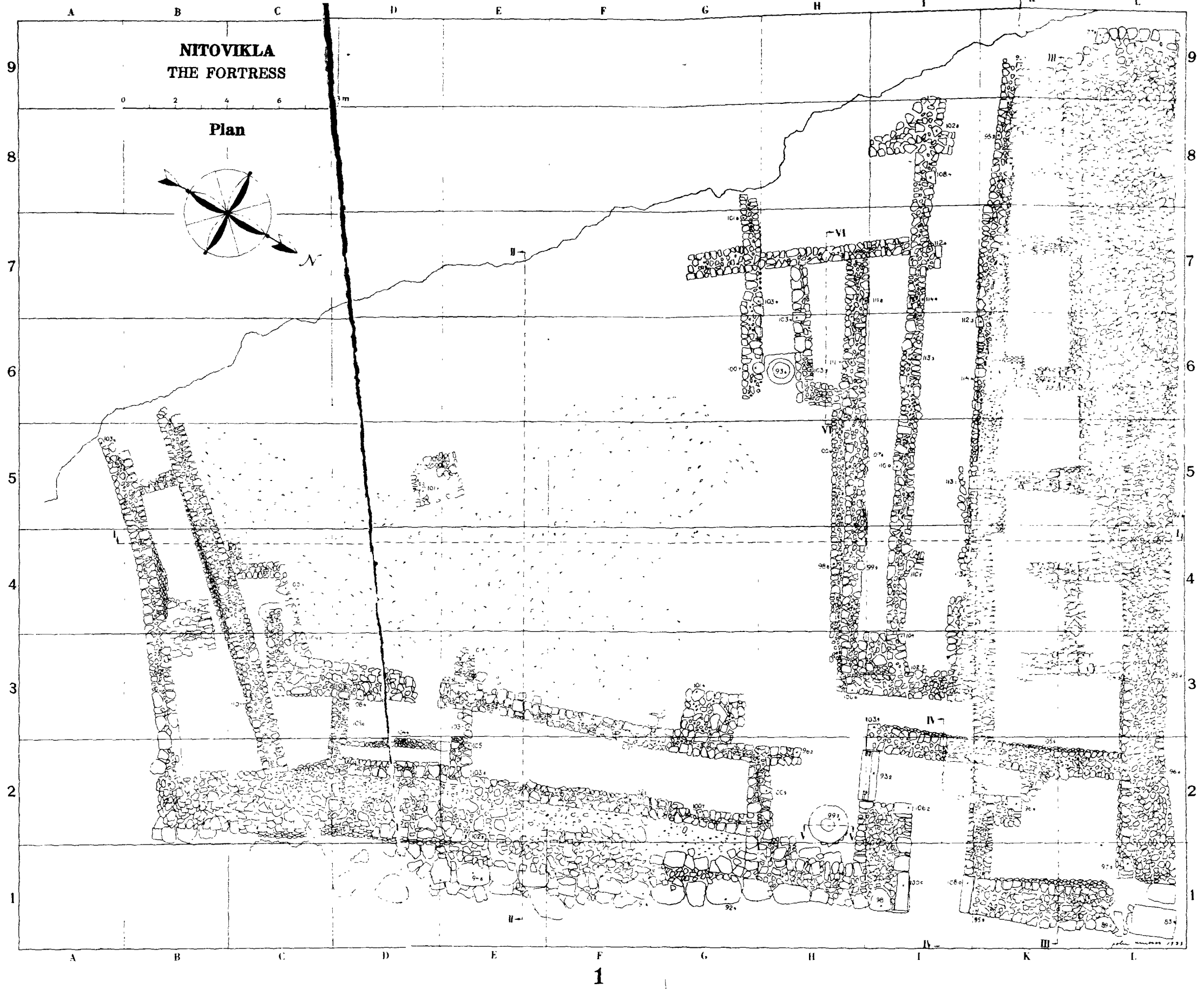

Sections

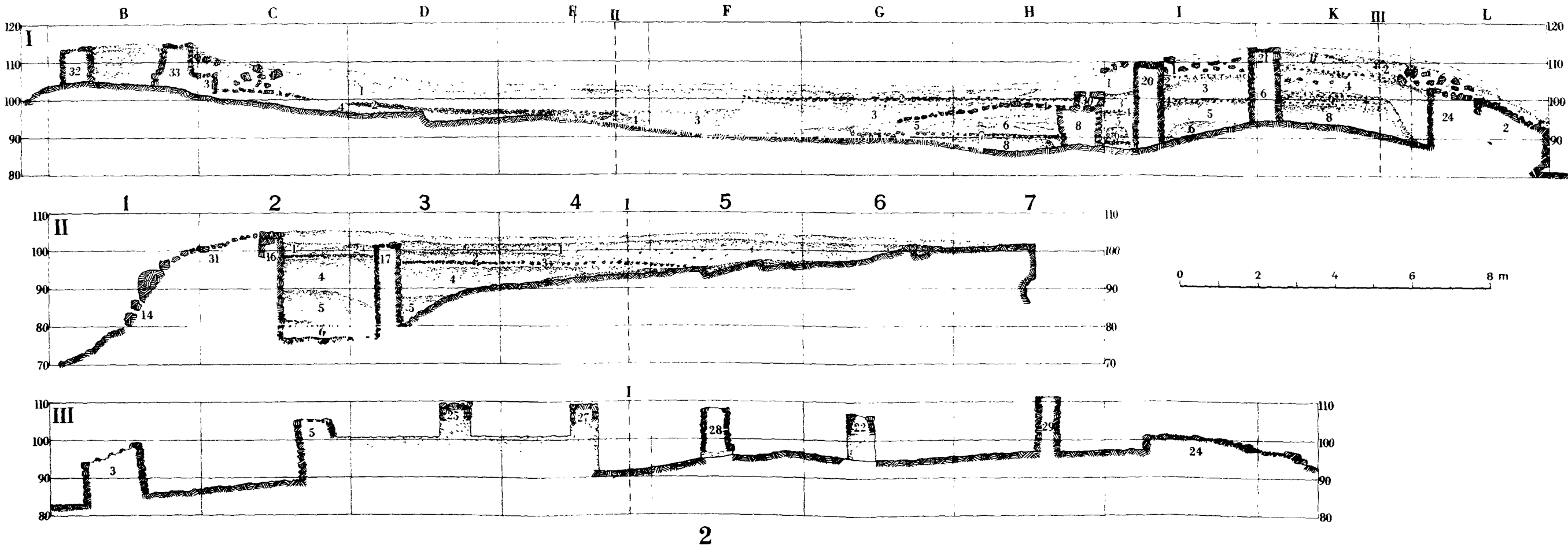

2

NORTHERN FAÇADE OF WALL 2

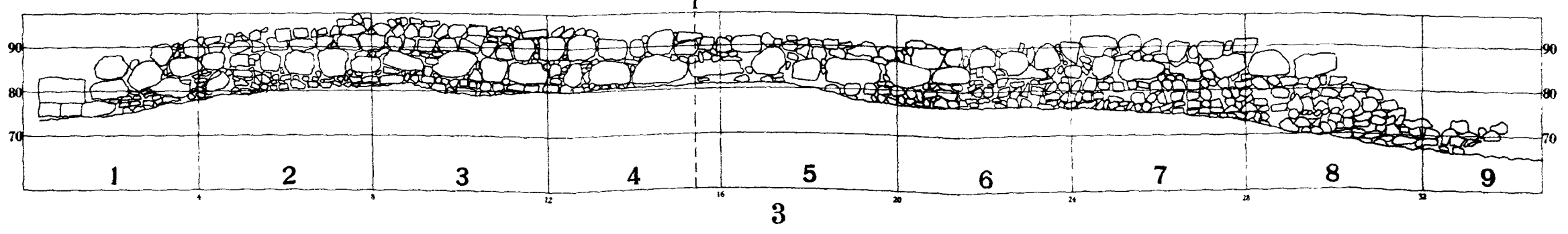

3

John Henry 1933

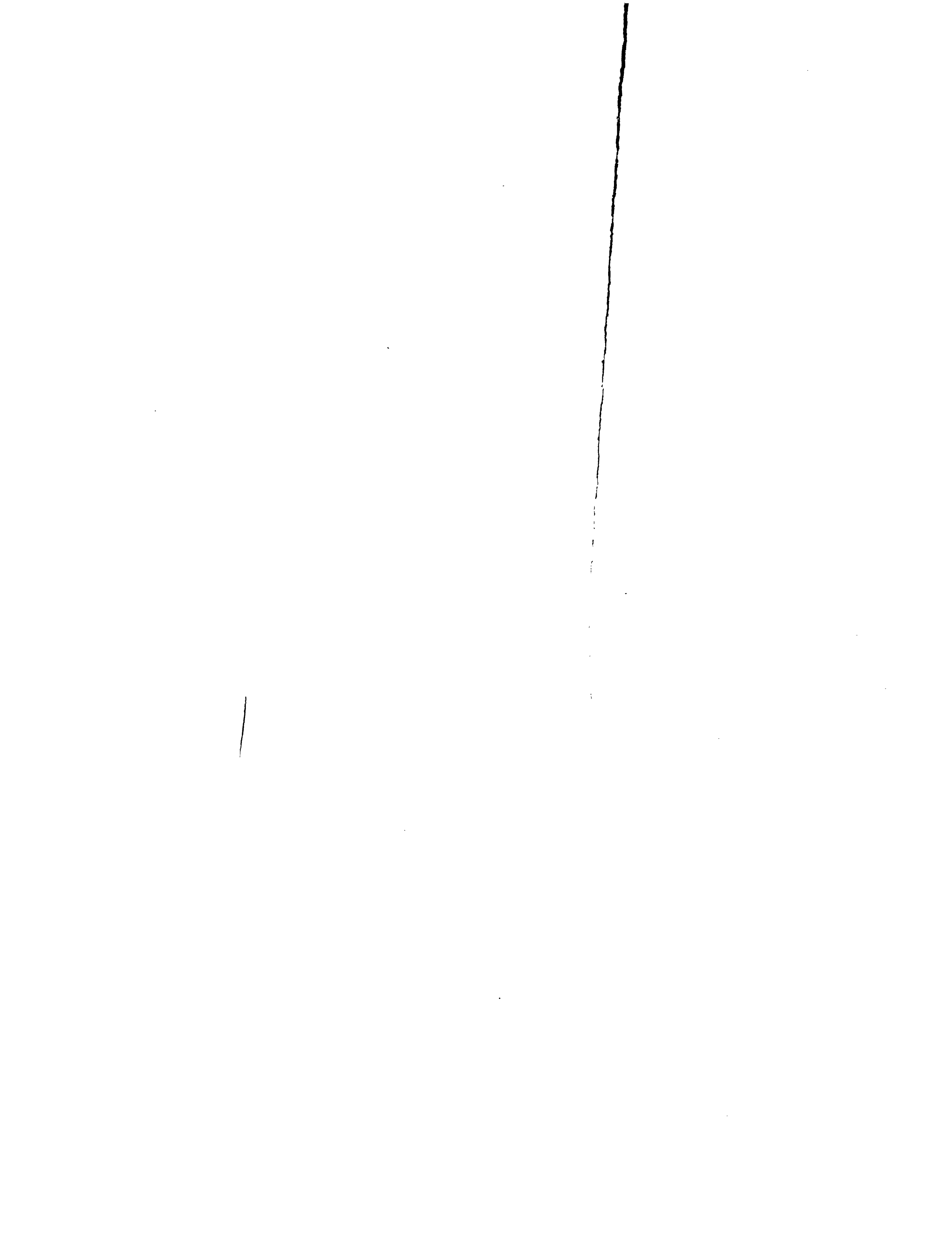

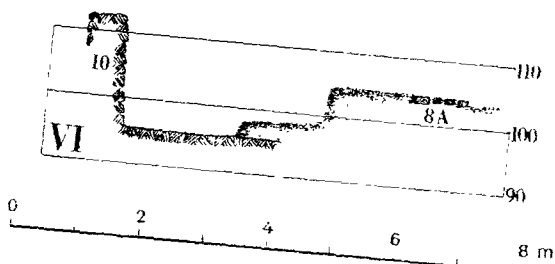
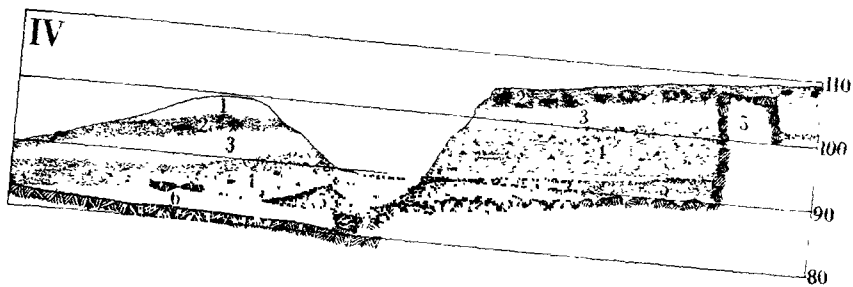

1

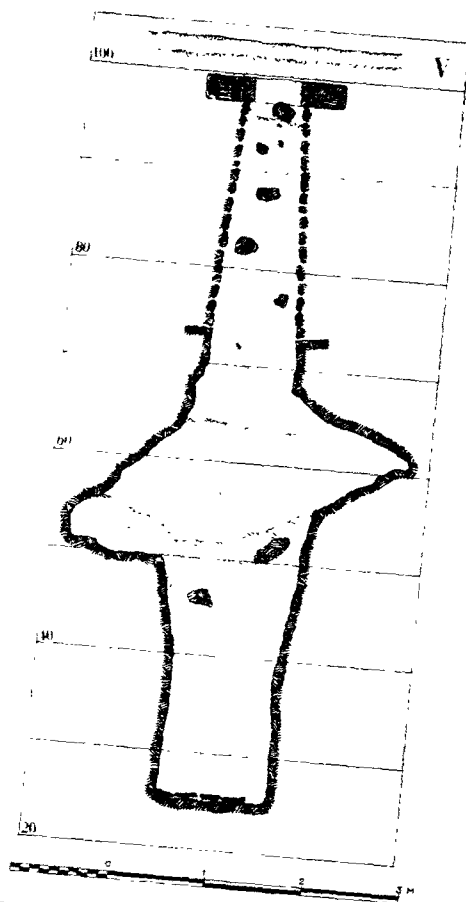

EASTERN FAÇADE OF WALLS 14, 13, 4, 3, 2

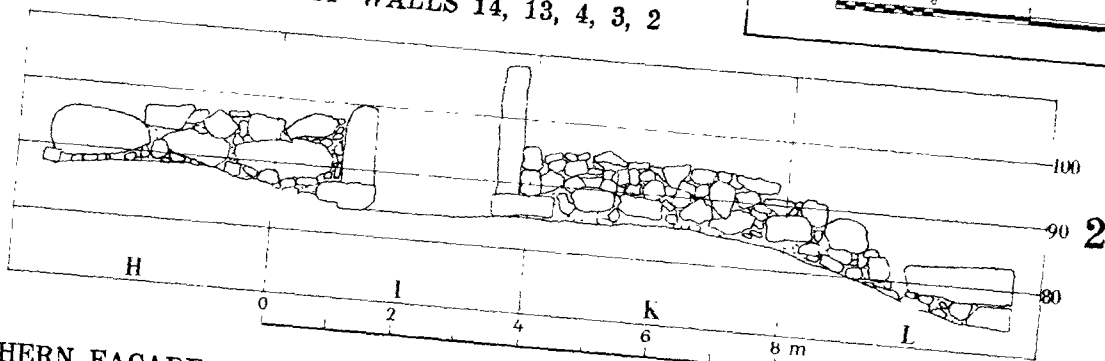

2

SOUTHERN FAÇADE OF WALL 4

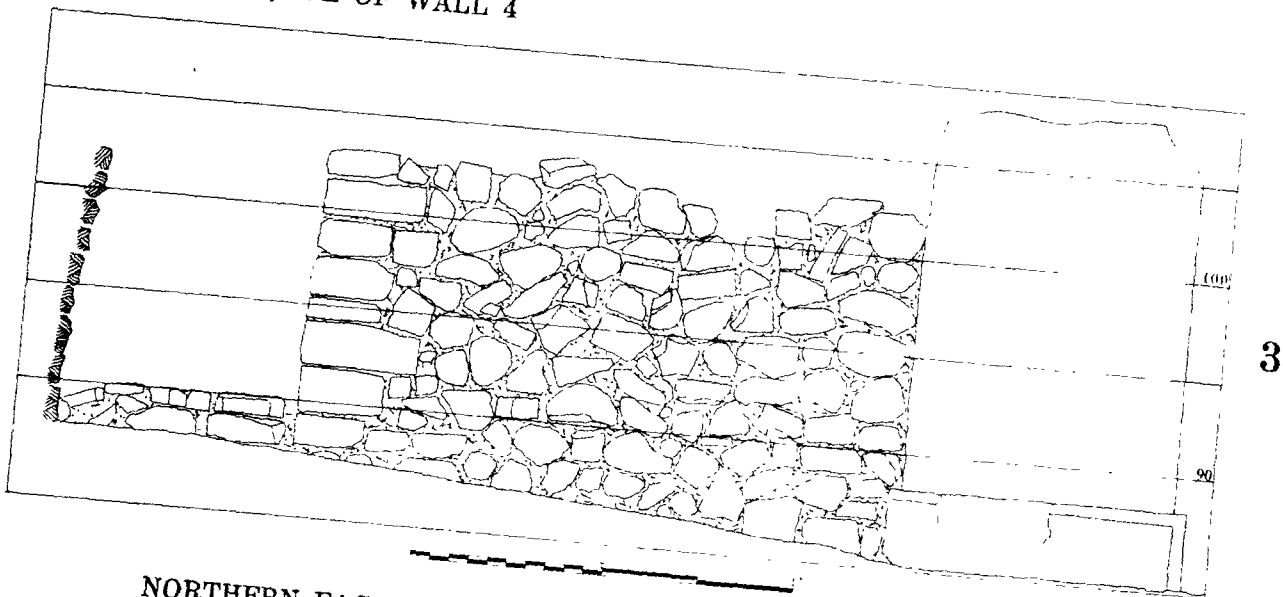

3

NORTHERN FAÇADE OF WALL 13

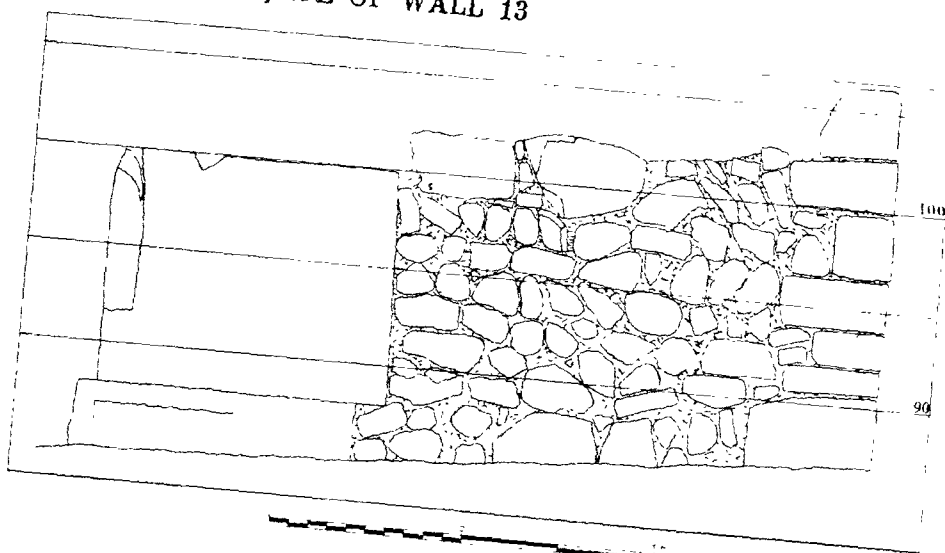

4

of the courtyard, which was relaid at the beginning of Period III A. They are also found at the inner gate, the Western Casemates, on the floor of the Kitchen, and to the north of Wall 2, all places where the architecture of Period II A survived to the end of the last period.

The question remains how long Period III A lasted: we have no sherds that can be safely dated to Late Cypriote II in the whole Fortress. The Levanto-Helladic sherd in the northern entrance tower and the fragments of the large stirrup-vase in the Gateway are certainly the two latest ceramic specimens found, but neither of them is, as far as I can see, dateable to 1400 B. C. or later. I omit, of course, the Iron Age sherd and the Hellenistic cup found in the Cistern, which only serve to show how long it was open, and in use, after the destruction of the old Fortress. The discussion seems, therefore, to show that the Fortress was abandoned before Late Cypriote II; consequently, the end of Period III B falls within Late Cypriote I. Considering the apparently short duration of the two sub-periods II B and III B, we are able to suggest the following chronology:—

Period I	M. C. III A.
Period II A)	M. C. III B and C.
Period II B)	
Period III A)	L. C. I A and B.
Period III B)	

The Necropolis

The above-mentioned, small necropolis connected with the settlement of Nitovikla, was found at the east end of the area, outside the two great eastern bastions. It is surrounded by walls, which, however, except for the eastern one, are in a very ruined condition. They are of considerably smaller dimensions than the city walls, but are constructed in the same way of rough stone blocks without mortar.

Twelve tombs were found opened, and all had been rifled in modern times. They were said to have contained Late Cypriote pottery, and a few scarabs and cylinders.

In spite of a very thorough investigation with trial pits all over the area, we did not succeed in finding more than three intact tombs.

TOMB I (Fig. 159: 1—4)

	SIZE		
	Length	Width	Depth
Dromos	1.93	1.06	1.11
Stomion	0.72	0.89	—
Chamber	2.03	2.72	—

SHAPE

The dromos is a small, oblong pit which widens gradually towards the entrance of the chamber. All the corners are rounded, and the cutting is rather careless. The floor slopes gently towards the stomion, and the sides of the dromos are roughly perpendicular. The door was blocked by a vertical slab of local limestone and some small stone wedges. Immediately inside the door stone is a low step which marks the beginning of the stomion. The roofs of stomion and chamber were fallen in, but the former could be reconstructed as a horizontal tunnel, ending with a short step down to the level of the chamber floor. The shape of the chamber is irregular and the right-hand portion of the floor is sunk about 0.15 m. lower than the rest.

STRATIFICATION

The dromos was filled with three layers of fine *chavara* waste. The lower two sank slightly before the doorway, but the upper was unbroken over stomion and chamber. The filling of the latter consisted of three strata of debris from the roof, and a small fan-shaped layer of dromos earth, limited to the area inside the door. Immediately below these masses of extraneous earth, lay the burial and culture stratum resting on the floor: it contained all the finds and the remains of three bodies. To judge from the above stratification, the tomb was only used for a short time, the three burials taking place more or less simultaneously.

BURIALS

Of the three bodies, only two skulls and some mouldered skeletal fragments were left; therefore, nothing can be said concerning the burial customs of this tomb.

FINDS (GROUPS: PL. LXIX, I, 2; TYPES: L. OF PL. II)

1. Biconical spindle-whirl of terracotta. Diam. 3.1. Floor.
2. Red-on-Black globular jug with round base; short, concave neck; splaying rim, and a high, arched handle from rim to shoulder. Horizontal bands of parallel lines around rim and shoulder. Handle missing. Height 6.6. Floor.
3. Biconical spindle-whirl of terracotta. Diam. 4.1.
Black Slip biconical spindle-whirl. Diam. 3.4. Floor.
4. Black Slip II globular jug with round base; cylindrical neck; splaying rim, and handle from rim to shoulder. Height 13.0. Floor.
5. Red-on-Black globular jug with round base; concave neck; splaying rim, and handle from rim to shoulder. Bands of horizontal lines around neck; zig-zag designs between bands of vertical lines from neck to base. Height 12.3. Floor.
6. Elongated, spherical mace-head of grey stone, pierced by a tapering hole through centre. Length 6.9. Floor.
7. Red-on-Black shallow bowl with round base; in-curving rim, and a rising loop-handle below rim. Groups of parallel, wavy lines crossing the bottom at right angles, both within and without; transverse lines on handle. Diam. 8.0. Floor.
8. Red-on-Black jug, as No. 2. Bands of parallel lines around neck, and bands of vertical lines from neck to base; transverse lines on handle. Height 8.3. Floor.
9. White Painted IV globular jug with cylindrical neck; splaying rim, and handle from rim to shoulder. Encircling lines around neck; body covered with alternating straight and wavy lines from neck to base, ending in a wheel-ornament on base. Rim chipped. Height 14.1. Floor.
10. Thin, straight bronze needle, with an eyelet at top. Broken. Length 11.5.
Short, thick bronze needle, pierced by an eyelet near the pointed end. Length 6.8.
Straight bronze pin with small, flattened head, pierced by an eyelet halfway down the shaft. Broken. Length 9.3.
Bronze pin, pierced by an eyelet halfway down the shaft. Length 7.6.
Fragment of a thick bronze pin. Length 6.7. Floor.
11. Plain bronze ring with overlapping ends. Diam. 3.7. Floor.
12. Leaf-shaped bronze knife with two edges; straight sides, and rounded top; four rivet-holes. Length 9.6. Floor.
13. Red-on-Black jug, as No. 8. Height 7.6. Floor.

14. Black Slip biconical spindle-whirl. Surface worn. Diam. 3.3.
Flat, oval spindle-whirl of terracotta. Diam. 3.6.
Black Slip, biconical spindle-whirl. Surface worn. Diam. 4.0.
Biconical spindle-whirl of bone. Diam. 4.2. Floor.
15. Red-on-Black jug, as No. 8. Height 8.3. Floor.
16. Black Slip II miniature globular jug with round base; concave neck, and handle from rim to shoulder. Rim chipped; paint worn. Height 7.4. Floor.
17. Red-on-Black jug, as No. 8, but larger. Neck missing. Height 13.8. Floor.
18. Black Slip II globular miniature jug with round base; cylindrical neck, and an arched handle from rim to shoulder. Paint worn. Height 7.7. Floor.
19. Black Slip biconical spindle-whirl. Diam. 2.6.
Black Slip spherical spindle-whirl. Diam. 3.8. Floor.
20. Straight bronze pin, tapering to a point; very small, flattened head, and an eyelet halfway down the shaft. Length 11.4. Floor.
21. Narrow, leaf-shaped, double-edged bronze knife with midrib; straight sides; rounded top, and two rivet-holes. Length 10.1. Floor.
22. Red-on-Black jug, as No. 5. Bands of horizontal lines around neck and shoulder; bands of vertical lines from shoulder to base, and transverse lines on handle. Paint worn. Height 10.4. On top of No. 23.
23. Red-on-Black jug, as No. 8. Height 10.4. Floor.
24. Red-on-Black jug, as No. 8. Height 13.4. Floor.
25. Black Slip II miniature globular jug, as No. 16, but with an arched handle from rim to shoulder. Paint much worn. Height 6.4. Found on top of No. 26.
26. Red-on-Black jug, as No. 8. Height 9.1. Floor.
27. Short, straight bronze pin tapering to a point; small, flattened head, and an eyelet halfway down the shaft. Length 7.5. Floor.
28. Red-on-Black globular jug with round base; concave neck, splaying rim, and handle from neck to shoulder. Decorated as No. 22. Paint worn. Height 19.8. Floor.
29. Three bronze pins, as No. 27. One badly corroded and incomplete. Length 10.9; 8.9; 7.5. Floor.
30. Thin, straight bronze pin with a loop-head, and a wire wound round below it. Length 8.1. Floor.
31. Black Slip II globular jug with round base; distinct shoulder; cylindrical neck; splaying rim, and handle from neck to shoulder. Paint much worn. Height 10.2. Floor.
32. Spherical spindle-whirl of unburnt clay. Diam. 4.4.
Black Slip spherical spindle-whirl. Worn. Diam. 4.1. Floor.
33. Red-on-Black jug, as No. 8. Height 8.5. Floor.
34. Red-on-Black jug, as No. 28. Paint worn. Height 10.2. Floor.
35. Red-on-Black jug, as No. 8. Height 9.2. Floor.
36. Leaf-shaped, double-edged bronze knife with midrib; straight sides; indented, flat tang, and four rivet-holes. Point broken. Length 18.5. Floor.
37. Rectangular, double-edged bronze scraper with midrib, and short, narrow tang. Length 10.5. Floor.
38. Oblong whetstone, pierced horizontally at one end. Length 8.2. Floor.
39. Leaf-shaped, double-edged bronze knife with midrib; straight sides; pointed top, and three rivets. Point missing. Length 10.5. Floor.
40. Red-on-Black jug, as No. 28. Height 31.3. Floor.
41. Fragments of two bronze pins; badly corroded. Floor.
42. White Painted IV jug, as No. 9. Friezes of hatched lozenges and triangles on shoulder, and a cross-ornament on bottom. Paint badly worn; rim and handle missing. Height 7.2. Floor.
43. Red-on-Red jug, as No. 2, but with beaked mouth. Irregular, horizontal lines around shoulder. Handle and spout missing. Height 7.8. Floor.
44. Red-on-Red globular jug, as No. 4. Bands of parallel lines around neck and shoulder, and bands of horizontal lines from neck to base. Handle missing. Height 9.4. Floor.
45. Red-on-Black biconical spindle-whirl. Worn. Diam. 4.0.
Black Slip spherical spindle-whirl. Diam. 3.0.
Black Slip spindle-whirl, as above. Diam. 3.4. Floor.
46. Elongated, spherical mace-head of stone with a tapering hole through centre. Length 7.5. Floor.

Summing up the Object Register, we obtain the following diagram:

P o t t e r y				B r o n z e					Terracotta	S t o n e	
Bl. Sl. II	Red-on-Black	Red-on-Red	Wh. P. IV	Knives	Scraper	Needles	Pins	Ring	Spindle-whirls	Mace-heads	Whet-stone
4. 16	2. 5. 7	43. 44	9. 42	12. 21	37	10. 10	10. 10. 10	11	1, 3, 3	6	38
18. 25	8, 13. 15			36. 39			20. 27. 29		14, 14. 14	46	
31	17. 22. 23						29. 29. 30		14. 19. 19		
	24. 26. 28						41. 41		32. 32. 45		
	33. 34. 35								45. 45		
	40										
-5	-15	-2	-2	-4	-1	-2	-11	-1	-14	-2	-1

CHRONOLOGY

The diagram shows that the contents of the tomb are fairly homogeneous. The Red-on-Black Ware dominates among the pottery in a remarkable way. The tomb dates from the Middle Cypriote III period.

TOMB 2 (Fig. 159: 5—8)

	SIZE		
	Length	Width	Depth
Dromos	1.69	0.86	1.06
Stomion	0.23	0.80	—
Chamber	2.40	2.68	—

SHAPE

The plan of the tomb resembles that of Tomb 1. The dromos is small, but more regularly cut, and has a horizontal floor. The walls are roughly perpendicular, the stomion is short and horizontal, and ends in an abrupt step down to the chamber floor. The difference in level between stomion and chamber is c. 0.45 m. The door stone was found removed to the back of the dromos, and stomion and chamber had collapsed. The chamber is roughly circular in shape, and the roof can be reconstructed as a low, flat vault. The left side of the chamber is 0.10 m. lower than the rest.

STRATIFICATION

The dromos had recently been excavated by tomb-robbers and the door stone removed; but when they found that the chamber was filled with debris from the collapse of the roof, they never carried out the final excavation. The chamber was dug out from above and the following stratification observed: —

- 1) Below the surface layer and an oblique stratum of fine sand, lay four layers of *chavara* debris, representing different stages in the collapse of the chamber.
- 2) A layer of mixed dromos earth and stones in and below the stomion. This stratum is the filling of a trial pit, dug by the tomb-robbers through the debris of the stomion.
- 3) A culture layer consisting of burial remains, traces of mouldered wood, and dark earth. It rested on a thin stratum of broken *chavara*.
- 4) A layer of fine sand.
- 5) A burial layer resting on the floor.

The Layers 3 and 5 represent two different burial periods and were separated by an artificial filling (Layer 4); above this the *chavara* floor was spread. To the upper layer belong the objects Nos. 3—7, 17—19, 23—25, 30—31, 33—34, 39—41, 43—49, 52, 54, 58, 60, 63, 66, 70, and 72—73. The rest of the finds, i. e. Nos. 1—2, 8—16, 20—22, 26—29, 32, 35—38, 42, 50—51, 53, 55—57, 59, 61—62, 64—65, 67—69, and 71, were found on the floor with the exception of No. 28, which lay in Layer 5, but 0.03 m. above the floor.

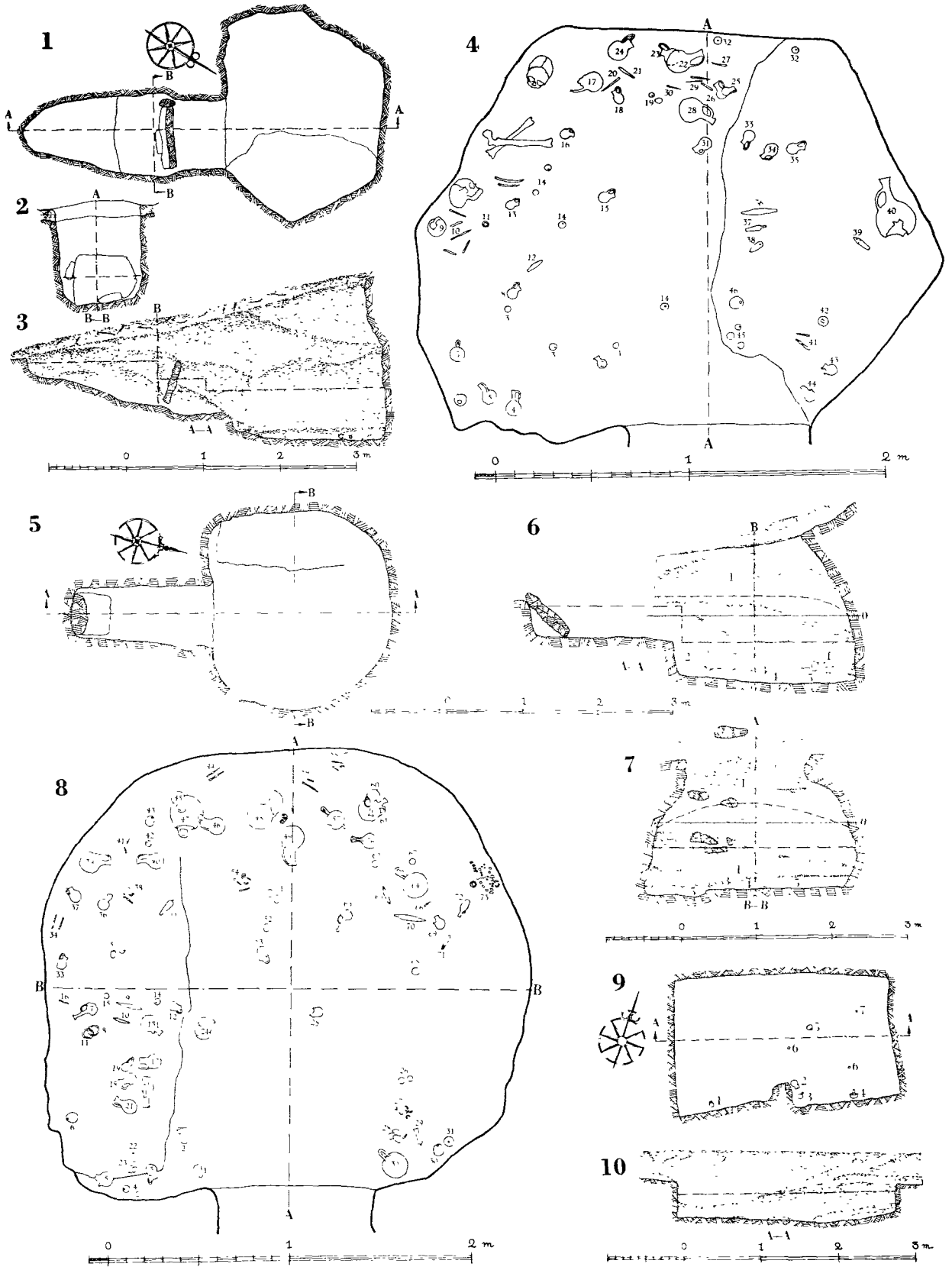

Fig. 159. Nitovikla. Tomb 1, Plan (1); Sections B-B, A-A (2, 3); Finds *in situ* (4). Tomb 2, Plan (5); Sections A-A, B-B (6, 7); Finds *in situ* (8). Tomb 3, Plan (9); Section A-A (10).

BURIALS

The bottom layer contained badly mouldered remains of four bodies, and the top layer three bodies in the same poor state of preservation. The abundant traces of wood which were found in the upper layer cannot be taken as evidence for the use of coffins for the dead bodies: these remains are mainly localized to a roughly circular area near one of the burial layers, and it seems, therefore, probable that they are the remnants of a wooden cist, or perhaps bowl, belonging to the tomb-gifts.

FINDS (GROUP: PL. LXIX, 3; TYPES: L. OF PL. II)

1. Red-on-Black globular jug with round base; short, concave neck; oblique mouth, and an arched handle from rim to shoulder. Parallel lines around neck, and groups of vertical lines from neck to base. Transverse lines on handle. Handle missing. Height 7.2. Floor.
2. Red-on-Black jug, as No. 1, but with splaying rim. Paint worn. Height 8.7. Floor.
3. Red-on-Black globular jug with round base; concave neck; splaying rim, and a high, arched handle from rim to shoulder. Horizontal bands of parallel lines around neck and shoulder, and vertical bands of parallel lines from neck to base. Transverse lines on handle. Paint worn. Height 11.1. — 81.
4. Red Polished spherical spindle-whirl. Diam. 2.6. Plain White biconical spindle-whirl. Diam. 4.1. — 79.
5. Red-on-Black jug, as No. 3. Horizontal bands of parallel lines around neck; bands of vertical lines from neck to base. Handle missing; rim chipped. Height 10.6. — 79.
6. Red-on-Black globular jug with round base; cylindrical neck; oblique mouth, and an arched handle from rim to shoulder. Decorated as No. 5. Neck and handle missing. Height 6.8. — 80.
7. Base-ring I depressed jug with tall, tapering neck; funnel-rim, and handle from neck to shoulder. The longitudinal axis of the jug leans backwards. Vertical relief-lines on body, and horizontal on neck. Height 13.8. — 79.
8. Circular bronze bracelet with overlapping ends; badly corroded. Diam. 6.3. Floor.
9. Leaf-shaped, double-edged bronze knife with midrib; slightly concave sides; flat, indented tang with three rivets. Badly corroded. Length 15.0. Floor.
10. Small, double-edged bronze knife with concave sides, and small, narrow tang. Length 10.1. Floor.
11. Circular bronze bracelet with overlapping ends. Diam. 6.2. Floor.
12. Red-on-Black jug, as No. 1. Height 6.6. Floor.
13. Black Slip II globular jug with round base; cylindrical neck, splaying rim, and a small, vertical string-hole projection at base of neck. Height 13.1. Floor.
14. Black Slip spherical spindle-whirl. Paint worn. Diam. 3.9. Floor.
15. Spherical spindle-whirl of terracotta. Diam. 2.9. Floor.
16. Fragments of a bronze pin with an eyelet halfway down the shaft. Much corroded. Length c. 5.2. Floor.
17. Red-on-Black jug, as No. 3, but with vertical bands of small, horizontal panels. Height 12.2. — 80.
18. Black Slip III globular jug with flattened base; wide, cylindrical neck; thin rim; pinched mouth, and handle from neck to shoulder. Paint obliterated. Height 9.5. — 82.
19. Red-on-Black jug, as No. 6. Height 8.6. — 81.
20. Red-on-Black quadrangular jug with flat base; splaying neck and rim, and handle from neck to shoulder. Parallel, wavy lines around neck, and groups of vertical, wavy lines from neck to base; transverse lines on handle. Rim chipped. Height 17.3. Floor.
21. Black Slip II globular jug with round base; concave neck; splaying rim, and an arched handle from rim to shoulder. Paint worn. Height 12.6. Floor.
22. Spherical mace-head of stone, pierced by a hole through the centre. Diam. 5.2. Floor.
23. Fragments of a White Painted IV jug. — 73.
24. Base-ring I squat jug with wide, tapering neck; flat rim, and a horned handle from rim to shoulder. Horizontal relief-lines around rim, and a wavy relief-line around body. Height 12.5. — 80.
25. Red-on-Black jug, as No. 6. Height 7.5. — 78.
26. Black Slip, spherical spindle-whirl. Diam. 3.8. Spherical spindle-whirl of terracotta. Diam. 3.3. Floor.
27. Fragments of several bronze rings; badly corroded. Floor.
28. Fragments of a White Painted IV jug. — 82.
29. Broad, double-edged bronze scraper with concave sides, and short, tapering tang. Tang broken. Length 9.8. Floor.
30. Almost spherical mace-head of stone with a tapering hole through the centre. Diam. 6.4. Floor.
31. Spherical mace-head of stone, as No. 30. Diam. 5.7. Floor.
32. Red-on-Black shallow bowl with round base, and a rising, horizontal handle on rim. Groups of parallel lines meeting at right angles, both within and without. Transverse lines on handle. Paint much worn. Diam. 13.8. Floor.
33. Red-on-Black jug, as No. 6. Paint obliterated. Height 7.6. — 82.
34. Two bronze pins, tapering to the points, and pierced by eyelets halfway down the shafts. Length 8.4; 7.2. — 78.

35. Triangular bronze knife with midrib, and straight sides. Point and tang missing; much corroded. Length 10.7. Floor.
36. Red Polished IV jug, as No. 21. Height 8.4. Floor.
37. Red-on-Black jug, as No. 2. Paint worn. Height 8.7. Floor.
38. Fragments of several bronze pins and rings; badly corroded. Floor.
39. Red-on-Black globular jug with round base; concave neck; splaying rim, and handle from rim to shoulder. Horizontal bands of parallel lines around neck and shoulder; bands of vertical lines from neck to base. Transverse lines on handle. Paint worn. Height 16.7. — 73.
40. White Painted IV globular jug with flattened base; cylindrical neck; splaying rim, and handle from rim to shoulder. Encircling lines around neck; body covered with alternating straight and wavy lines from neck to base. Surface worn. Height 14.2. — 75.
41. Fragments of two bronze pins with thickened tops. — 75.
42. Black Slip spindle-whirl, as No. 14. Diam. 3.6. Floor.
43. Oblong, ovoid mace-head of stone with a tapering hole through the longitudinal axis. Diam. 6.1. — 75.
44. Two bronze pins with thickened tops, and eyelets halfway down the shafts. Length 9.6; 9.7. — 71.
45. Red-on-Black jug, as No. 39. Paint worn. Height 12.0. Found on top of No. 47.
46. Red-on-Black jug, as No. 39. Height 16.3. — 71.
47. White Painted IV globular bowl with round base; contracted, out-turned rim; a knobbed, upright handle on rim, and a spout opposite the handle. Bands of wavy lines around rim and shoulder; an ornate frieze of hatched lozenges and encircled dots around shoulder; vertical bands of wavy line from shoulder to base, and transverse lines on handle. Spout missing. Diam. 12.8. — 83.
48. Red-on-Red jug, as No. 49. Height 24.3. — 76.
49. Red-on-Red globular jug with round base; tall, narrow neck; splaying rim, and handle from rim to shoulder. Encircling lines around neck and belly; vertical bands of parallel lines from neck to base, and transverse lines on handle. Below belly, the vertical bands are composed of horizontal lines. Height 21.8. — 76.
50. Bronze chain composed of three rings. Diam. c. 5.7. Floor.
51. Biconical spindle-whirl of terracotta with incisions. Damaged. Spindle-whirl, as above. Chipped. Diam. 4.3. Floor.
52. Black Slip biconical spindle-whirl with incisions. Damaged. Diam. 3.6. — 76.
53. Red-on-Black jug, as No. 1. Height 9.2. Floor.
54. Fragments of several bronze pins and rings; badly corroded. — 75.
55. Elongated, oval spindle-whirl of terracotta. Diam. 3.1. Spindle-whirl of terracotta, as above. Diam. 3.1. Floor.
56. Red-on-Black globular jug with round base; concave neck; splaying rim, and handle from rim to shoulder. Wavy lines around neck and shoulder; transverse lines on shoulder. Height 13.8. Floor.
57. Red-on-Black bowl, as No. 32, but with a loop-handle at rim. Paint slightly worn. Diam. 10.0. Floor.
58. Fragments of four bronze pins with thickened tops, and eyelets halfway down the shafts. — 71.
59. Bronze pin with a "mushroom-head", and an eyelet halfway down the shaft. Length 10.2. Fragment of a straight bronze pin. Floor.
60. Base-ring I jug, as No. 7, but with curved relief-lines on body. Height 14.5. — 71.
61. Red-on-Red globular jug with round base; concave neck; a knobbed handle from neck to shoulder, and two projections on shoulder opposite the handle. Parallel, wavy lines around rim and neck, and horizontal, wavy lines below and opposite the handle. Paint somewhat worn. Height 16.7. Floor.
62. Biconical spindle-whirl of terracotta. Diam. 3.4. Floor.
63. Base-ring I jug, as No. 7. Base-ring missing. Height 13.9. — 70.
64. Red-on-Red shallow bowl with round base; contracted rim, and a rising loop-handle at rim. Decorated as No. 32. Diam. 14.7. Floor.
65. Leaf-shaped, double-edged bronze knife with midrib; convex sides, and short, narrow tang. Length 11.3. Floor.
66. Fragment of a bronze pin; badly corroded. — 73.
67. Plain finger-ring of bronze; badly corroded. Diam. 3.2. Floor.
68. Spherical spindle-whirl of terracotta. Diam. 4.0. Floor.
69. Black Slip II jug, as No. 36. Height 7.7. Floor.
70. Leaf-shaped, double-edged bronze knife with midrib, and straight sides. Tang missing; badly corroded. Length 18.1. — 70.
71. Leaf-shaped, double-edged bronze knife with midrib; straight sides; rounded top, and two rivet-holes. Length 9.5. Floor.
72. Red-on-Red lentoid jug with flat base; narrow, concave neck; splaying rim, and a vertical string-hole handle between neck and shoulder. Horizontal, wavy lines around neck, shoulder, and body; vertical, wavy lines from neck to base. Height 10.7. — 73.
73. Necklace consisting of plain and fluted, spherical beads of faience, and smaller cylindrical beads. — 71.

Summing up the Object Register and distributing the finds between the two groups, we obtain the following diagram:

	Pottery							Bronze							Terracotta	Faience	Stone
	R. P. IV	Bl. Sl. II	Bl. Sl. III	Red-on-Black	Red-on-Red	Wh. P. IV	Base-ring I	Knives	Scraper	Pins	Ring	Bracelets	Chain	Fragments	Spindle-whirls	Necklace	Mace-heads
1st burial period	36	13		1, 2, 12	61	28		9	29	16, 59	67	8	50	27	14, 15, 26		22
		21		20, 32, 37	64			10		59		11		38	26, 42, 51		
		69		53, 56, 57				35							51, 55, 55		
							65								62, 68		
							71										
	-1	-3		-9	-2	-1		-5	-1	-3	-1	-2	-1	-2	-11		-1
2nd burial period			18	3, 5, 6	48	23	7	70		34, 34				54	4, 4, 52	73	30
				17, 19, 25	49	40	24			41, 41							31
				33, 39, 45	72	47	60			44, 44							43
			46			63				58, 58							
										58, 58							
										66							
			-1	-10	-3	-3	-4	-1		-11				-1	-3	-1	-3

CHRONOLOGY

The presence of the Base-ring I Ware in the second group together with a majority of Middle Cypriote pottery, among which the Red-on-Black Ware predominates, dates the group to the beginning of Late Cypriote I. The first group consists exclusively of Middle Cypriote pottery, but precedes the later group only by a comparatively short space of time, to judge from the absence of accumulated, extraneous earth between the layers. It must, therefore, be dated to the end of the Middle Cypriote III period.

TOMB 3 (Fig. 159: 9—10)

SIZE

Length	Width	Depth
2.92	1.80	0.48

SHAPE

The tomb is a shallow, rock-cut shaft, roughly rectangular in shape with a projecting buttress on one of the long sides. The sides are perpendicular, and the floor roughly horizontal.

STRATIFICATION

The rock was covered by c. 0.40 m. of field earth, of which the top 0.30 m. was turned up by the plough. The shaft was dug out and re-filled in modern times for more than three quarters of the total area. The intact section revealed a very simple stratification:

a burial layer was found directly on the rock-floor, and the shaft was filled to the brim by finely pulverized *chavara*. A few finds lay in the bottom stratum and on the floor. No skeletal material was preserved.

FINDS

1. White Painted IV globular jug with round base; concave neck; splaying rim, and an arched handle from rim to shoulder. Wavy lines around neck; hatched triangles on shoulder, and wavy lines meeting in a cross on the bottom. Handle missing. Height 7.6. Floor.
2. White Painted IV globular jug with round base; cylindrical neck; splaying rim, and handle from rim to shoulder. Horizontal lines around neck; body covered with alternating straight and wavy lines from shoulder to base. Height 12.7. Floor.
3. Red-on-Red jug, as No. 1. Vertical stripes from neck to shoulder. Surface worn; handle missing. Height 8.5. Floor.
4. Black Slip II shallow bowl with round base; straight, vertical rim, and an upright, horizontal handle on rim. Black outside; white, unpainted inside. Diam. 11.3. Floor.
5. Red Polished IV globular jug with round base. Neck and handle missing. Height 7.0. Floor.
6. Spherical spindle-whirl of terracotta. Diam. 4.4.
7. Biconical spindle-whirl of terracotta. Diam. 3.8. Floor.
8. Biconical spindle-whirl of terracotta. Diam. 3.2. Floor.
8. Fragment of a straight, thick bronze pin. Floor.

Summing up the Object Register and classifying the finds, we obtain the following diagram: —

P o t t e r y				Bronze	Terracotta
R. P. IV	Bl. Sl. II	Red-on-Red	Wh. P. IV	Pin	Spindle-whirls
5	4	3	1. 2	8	6. 6 7
-1	-1	-1	-2	-1	-3

CHRONOLOGY

The above-described finds are only a small percentage of the objects, once deposited in the tomb; but, as no potsherds were found in the removed earth, they are the only criterion for the date of the tomb. All indicate the dating of the burial to the Middle Cypriote III epoch.

E. S.

P A L E O S K O U T E L L A

The Necropolis

INTRODUCTION

A mile and a half north of the Fortress of Nitovikla, midway between the villages of Korovia and Gallinoporni, lies the necropolis of Paleoskoutella on a high, wooded hill close to the road. An ancient causeway, now almost entirely hidden by an abundant vegetation of bushes, leads along the south side of the hill up to the spacious plateau (Fig. 160).

The steep, western cliffs have in two places broken away and revealed a tomb cut in the rock, containing heaps of broken pottery belonging to the end of the Middle Bronze Age. In the centre of the plateau, was a deep crevice filled with stones and earth, marking the position of another fallen-in tomb.

The necropolis is of an, as yet, unknown type in Cyprus (Plan IV, 1). The plateau is dominated by a very large tumulus in a central position surrounded by several smaller ones, placed at regular distances from each other. Some of the latter are badly destroyed, and some have almost vanished, but the whole cemetery seemed to have contained some twenty tombs. No tombs of the usual Cypriote type, without tumulus, could be found. Not only the type of tomb but also the position of the necropolis on a hilltop is unparalleled in Cypriote Bronze Age with the possible exception of Leondari Vouno near Nicosia.

Seven of the tumuli were investigated, among them the large central one.

TUMULUS I (Figs. 161; 162; 163: 1—7; 164)

SIZE		
Length	Width	Height
c. 8.75	c. 6.00	c. 1.65

SHAPE AND STRATIFICATION

The tumulus was a low heap of stone and earth piled up on a roughly oval area. The stones were all crude blocks of local stone of a hard, calcareous structure, and their sizes varied from a maximum of c. 0.50 m. in length to small chips.

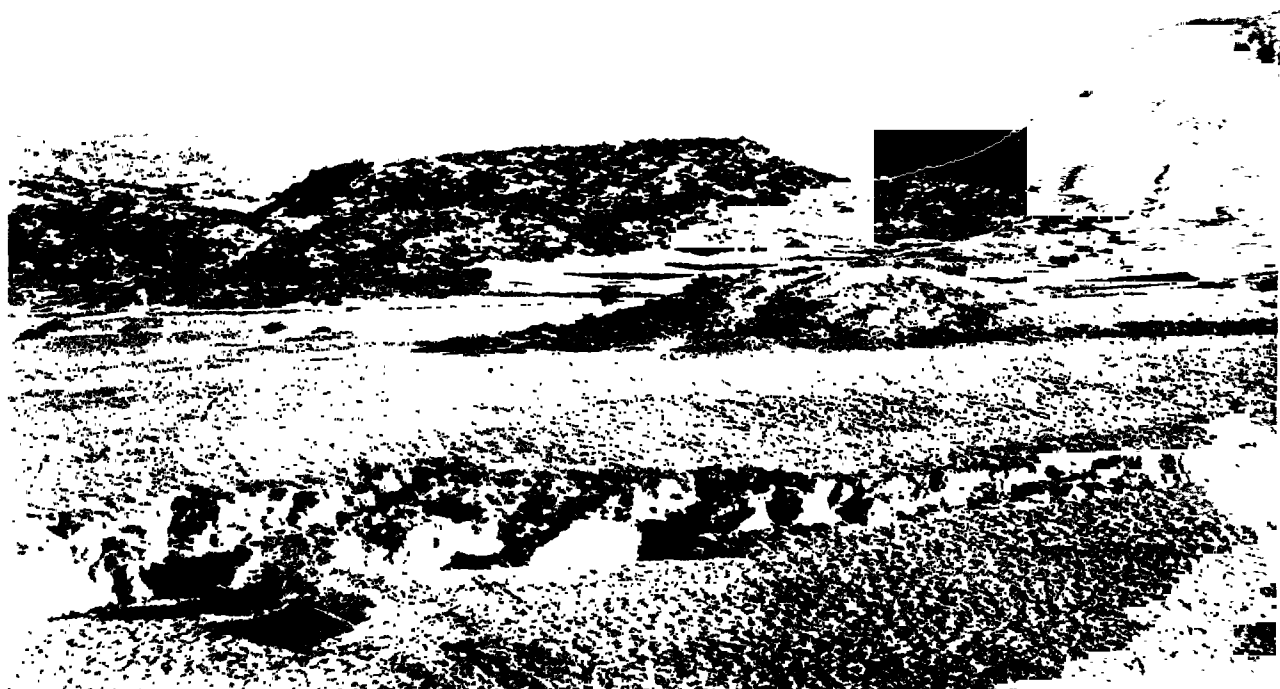

Fig. 160. Paleoskoutella. The hill of the necropolis, seen from the South.

At the W. long side of the tumulus, the stones were laid in a sort of retaining wall founded on the lower strata, thus giving strength, and a certain distinct shape to the construction. The S. end of this wall turned almost at right angles to the East, where a short wall of similar construction joined the first. The area enclosed by these two stone revetments formed the central part of the tumulus on which the upper stones were piled.

The interior structure of the mound was revealed by a longitudinal section. The majority of the stones were found in the surface layer, and the interior consisted to a great extent of earth.

On the W. side, especially along the retaining wall, the stones were very frequent, but in the N. section, the filling consisted mainly of earth. The stratification showed a conical layer, 1.10 m. thick, consisting of obliquely stratified earth, mixed with rocky matter and stones. It rested on a horizontal layer of white limestone waste which covered the rock. On all sides of the conical, stony layer, which should be considered as the heart of the mound, ordinary earth containing some gravel and small stones was shovelled up, so that the area of the tumulus grew larger and its sides sloped more gradually. Finally, the construction was revetted with the above-mentioned stones.

The tumulus was thus trenched and studied, but no traces of burial or tomb were found; so the whole mound was dug up and removed, and the area on which it was erected was laid bare. This area — c. 9.10 × 5.60 m. — consisted of the roughly levelled natural rock,



Fig. 161. Paleoskoutella. Tumulus 1 before excavation.

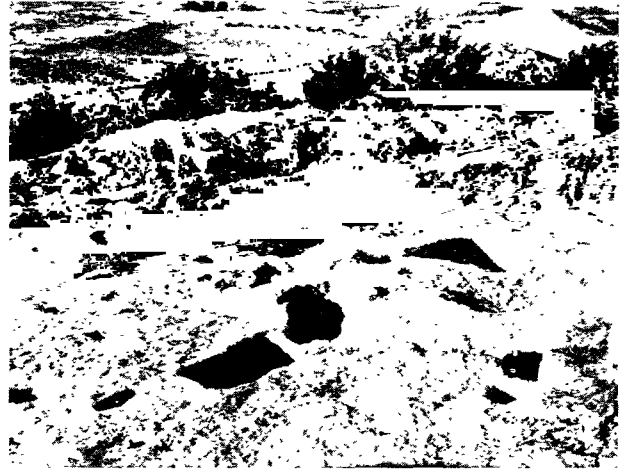

Fig. 162. Paleoskoutella. The cult place found below Tumulus 1.

separated into a northern and a southern section. The latter is an approximately square area with a roughly worked, horizontal floor: originally the natural rock sloped gently westwards, and, thus, the eastern edge of the levelled area formed a sharply cut ledge. The N. and S. edges of the area also formed gradually rising ledges. Within these defined borders are several cuttings in the rock. In the N. E. corner is a small cavity (No. 1), shaped like a niche, cut into the side of the ledge: its entrance started from a cylindrical pit like a miniature dromos, and was closed by a small, circular stone. The total length of the complex is 0.58 m., and its maximum width 0.43 m. Immediately behind the entrance of the niche is a narrow, cylindrical pit, 0.25 m. deep and 0.20 m. in diameter (No. 2). Following the N. ledge for 1.35 m. towards the West, we find a circular pit (No. 3), 0.46 m. in diameter, and 0.60 m. in depth. Close to it is a rectangular basin (No. 4) of approximately the same depth: its length is 0.95 m. and its width 0.48 m. The cuttings Nos. 5, 6, 7, 9, and 11 are small circular or oblong holes of the same type as, and approximate size of No. 2. They are spread about the central part of the area. In the S. W. corner, diagonally opposite the niche No. 1, is a circular pit sunk in the rock floor. From the bottom of this pit opens on a small chamber, roughly circular in shape. The construction is essentially of the same type as the so-called "chimney-tombs" in Enkomi (cf. below p. 573), but of miniature size. Thus the entrance pit has a diameter of 0.64 m. and a depth of 0.85 m. and the chamber a diameter of 0.75 m. and a height of 0.68 m. Finally, in the S. E. part, two other circular pits of approximately the same shape and size as No. 3 were found (Nos. 10 and 12). The former was covered by a circular slab of local limestone.

The N. section of the main area is somewhat more irregular. Its eastern part lies at a higher level than the west, and is pierced by the small, circular pits Nos. 13, 14, 17, 18, and 19, all of the same type as No. 2 mentioned above. They are grouped on both sides of a roughly rectangular basin 1.25 × 0.70 m., and about 0.35 m. in depth. At the bottom

of this shaft is an outlet cut like a pipe through the rock, and starting from the centre of the short, west side. It is 0.35 m. long, and opens into the cylindrical pit, No. 16, situated at the edge of the western, or lower part of this section of the main area. Its mouth lies about 0.15 m. lower than the bottom of the basin, No. 15.

To complete the description of the site the following observations should be noted with regard to the earth-filling of all these cavities.

Close to the N. border of the S. section was a layer of dark earth, mixed with *chavara* material and a few potsherds. In the bottom of Pits Nos. 3, 4, and 10 lay thin strata of sticky, dark earth, containing some sherds and fragments of burned animal bones; the "chamber" of Pit No. 8 was filled with dry earth of dark colour, probably emanating from some mouldered organic matter. Basin No. 15 and Pit No. 16 held thick layers of culture earth of the same consistency as those observed in Pits Nos. 3, 4, and 10, but containing a greater percentage of splinters of animal bone. Above the basin, there was an accumulation of dark, finely pulverized earth with many bones. On the ledge near the E. side of the S. section, a small jug of Black Slip II Ware was found. The rest of the pits were filled with the white, sterile *chavara* earth which covered the whole area, and above which the tumulus was erected.

The interpretation of the many unique features of the area found below Tumulus I will be given further on. It is sufficient here, to state that neither a tomb, nor anything indicating a permanent dwelling-place, was found. The ledges, the numerous pits and cavities, arranged according to an intricate system, and the presence of animal bones all point to one fact: that the place served as a cult place where sacrifices and other religious ceremonies have been carried out; further its position in the centre of a graveyard surely indicates that the dead were the objects of the cult.

CHRONOLOGY

Except for the single Black Slip II jug mentioned above and a spindle-whirl, no complete finds were obtained in the area. All the potsherds found in the bottom strata were collected and the diagram below shows their classification and proportion: —

	Bl. Sl. II	R. Sl.	Red-on-Black	Red-on-Red	Pl. Wh.	Red-on-Red + Wh. P. V	Total
Number of sherds	264	108	295	22	20	6	725
Percentage	36.5 %	14.9 %	40.5 %	3.1 %	4.1 %	0.9 %	100 %

Of the Red Slip sherds, approximately two thirds are more of a brown than red colour. Almost all the sherds, with the exception of the Plain White Ware, are fragments of shallow bowls, some of which are very advanced in shape with contracted rims. The Plain White sherds have belonged to large jars. The large amount of Red-on-Black Ware, the advanced shapes of the bowls, and the presence of the sherds of Composite Ware (Red-on-Red

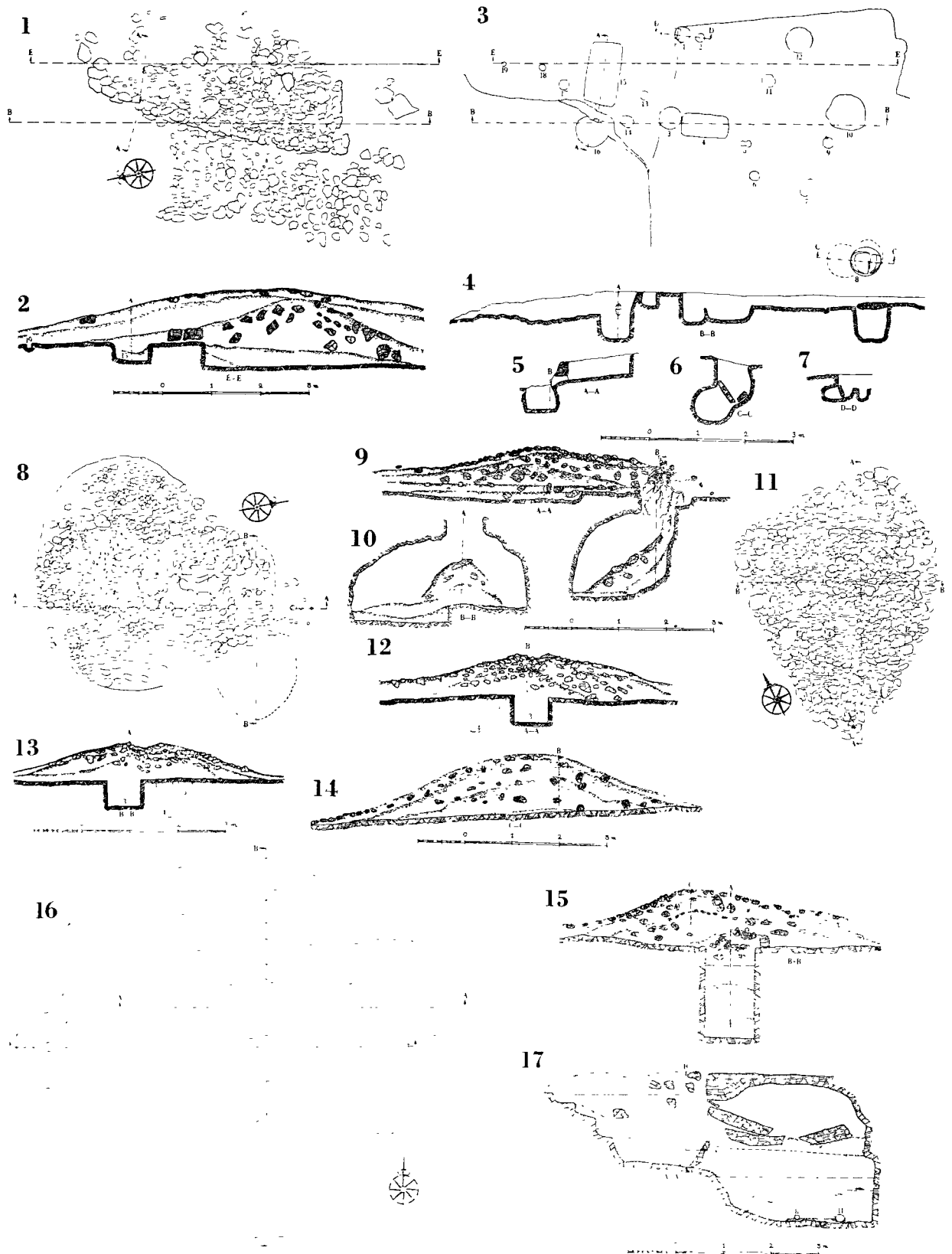

Fig. 163. Paleoskoutella. Tumulus 1, Plan of tumulus (1); Section E-E (2); Plan of excavated area (3); Sections B-B, A-A, C-C, D-D (4, 5, 6, 7). Tumulus 2, Plan (8); Sections A-A, B-B (9, 10). Tumulus 3, Plan (11); Sections A-A, B-B (12, 13). Tumulus 4, Sections C-C, B-B (14, 15); Plan of tumulus (16); Section A-A (17).

and White Painted V) date the deposit to the end of the Middle Cypriote III epoch. As the sherds were found mostly on the floor, this period denotes the last use of the cult place.

TUMULUS 2 (Figs. 163: 8—10; 165)

SIZE

	Length	Width	Depth	Height
Tumulus	c. 6.50	c. 6.00	—	c. 1.20
Entrance of the tomb	1.07	0.76	0.43	—
Tomb-chamber	1.99	3.68	—	1.71

SHAPE

The tumulus is a low mound of roughly circular plan: it is built up of three layers of reddish earth and rock material, very frequently mixed with crude stones of different size. The surface layer, especially, contains many stones. At the northern edge of the mound where a big *aoratos* tree was growing, most of the stones were missing. Here also the stratification of the tumulus was broken through, and the convex outline of the tumulus sank in to a concave curve. These circumstances show that the mound has been dug through at this point. Below there lay the tomb.

The shape of the tomb is that of a so-called "chimney-tomb" (cf. pp. 418 and 573); it is entered by a circular hole in the roof, which leads directly down to the chamber without stonion, or steps. The chamber is "kidney-shaped" and slightly asymmetrical. The eastern half of the floor lies c. 0.40 m. lower than the rest. The structure is well preserved and the roof forms a curved vault. The stone slab which covered the entrance hole had fallen into the chamber, evidently pressed down by the roots of the *aoratos* tree.

STRATIFICATION

In the chamber the stratification was very simple. No traces of culture earth were found. The filling consisted of two fan-shaped layers of surface earth, which had intruded through the entrance, and one horizontal stratum of fine rock debris, resting directly on the floor. In this layer some potsherds were found (cf. below). The closing stone was found on top of the upper layer; consequently, very much extraneous earth had not poured in after the stone had fallen in. This was due also to the fine network of roots from the tree which were plaited into an almost tight roof. If the tomb was used for burial purposes — and it is difficult to suppose that it was not — the body and its tomb-gifts have been removed. It is difficult to fix the date of the reopening of the tomb, but one or two circumstances which might throw light on the question, are worth mentioning: —

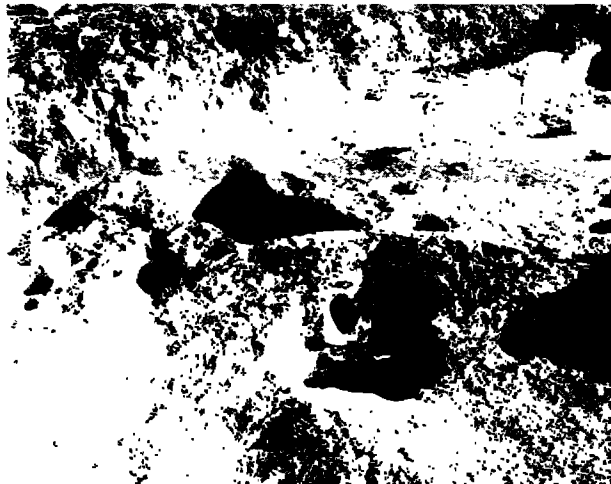

Fig. 164. Paleoskoutella. Tumulus 1. The communicating cavities 15 and 16.



Fig. 165. Paleoskoutella. Tumuli 2 and 3 before excavation.

1. The whole tumulus was intact except for the small area just over the tomb. This fact points to a rather remote epoch for the "robbery" as it seems to presume an exact knowledge of the position of the tomb in the large tumulus.
2. Bodies and tomb-gifts have been removed, and as the latter were very likely chiefly vases, it does not seem probable that the "robbery" took place in Byzantine, or modern times, when ancient tombs were — and are — sacked, merely for the gold and jewelry.
3. The age of the *aoratos* tree on top of the tomb could be estimated at about 60 years which is, in any case, a *terminus ante quem*.

All these circumstances therefore point to a remote epoch for the "robbery", but the matter will be discussed later (see pp. 437 ff.).

CHRONOLOGY

The few potsherds found in the bottom stratum are the only criterion for the dating of the tomb. The diagram shows their proportion and classification.

	Bl. Sl. II	R. Sl.	Red-on-Black	Pl. Wh.	Total
Number of sherds	9	11	33	6	61
Percentage	14.8 %	18.0 %	57.4 %	9.8 %	100 %

The Red-on-Black Ware which dominates the diagram, were all pieces of shallow bowls often with thin, contracted rims, and vertical loop-handles. The Red Slip sherds are to a great extent of a brown colour. The proportion and classes of the sherds date the stratum and, thereby the tomb, to the latter part of the Middle Cypriote III period.

TUMULUS 3 (Figs. 163: 11—13; 165)

SIZE

Length	Width	Height
c. 6.60	c. 5.00	c. 0.95

SHAPE AND STRATIFICATION

The tumulus has the same shape, structure and stratification as Tumulus 2: the stone-filling only is somewhat more compact. On the top of the mound the stones form a low, circular cavity. No tomb was found below. The rock was carefully smoothed to a horizontal floor into which five pits were cut. It is evidently a cult place of the same type as the one revealed below Tumulus 1, but on a smaller scale. Three of the pits are of rectangular shape, and two are round. They vary in depth from 0.35 to 0.70 m. The large, central basin contained a bottom layer of dark, sticky earth with potsherds and a few, burnt fragments of animal bones. Traces of ash and carbonized matter were found sporadically on the rock floor and in the pits.

CHRONOLOGY

The potsherds found in the bottom stratum of the tumulus and in the pits are collected in the following diagram: —

	R. P. IV	Bl. Sl. I-II	R. Sl.	Red-on-Black	Pl. Wh.	Total
Number of sherds	26	120	41	40	22	249
Percentage	10.4 %	48.2 %	16.5 %	16.1 %	8.8 %	100 %

In comparison with the two previous tumuli, the percentage of the Red-on-Black Ware is remarkably small. The Black Slip Ware is abundant, and must, to a great extent, be classified as Black Slip I Ware. These features, together with the presence of Red Polished IV Ware, point to a rather early stage of the Middle Cypriote III period, for the date of the tumulus.

TUMULUS 4 (Figs. 163: 14—17; 166: 1)

SIZE

	Length	Width	Depth	Height
Tumulus	c. 8.00	c. 8.00	—	c. 1.25
Dromos	3.22	1.09	2.04	—
Stomion	0.19	0.80	—	c. 0.60
Chamber	3.31	4.48	—	c. 1.45

SHAPE

The tumulus is approximately circular in plan: it contained comparatively few stones, and was composed of four layers of clay and rock material. Below the mound was found a rock-cut tomb.

The tomb did not lie exactly below the centre of the tumulus. The dromos is of the long and narrow corridor type, and is well cut with perpendicular sides, and three steps leading down from the further end to an oblong, flat area in front of the stomion. The face of the tomb is much eroded, and because of the gradual decomposition of the rock the stomion was, when excavated, much larger than originally. Its original height could be reconstructed by means of the door slab which was still *in situ*. The stomion is a short, wide passage ending in an abrupt slope down to the horizontal floor of the chamber.

The chamber is of an unusual plan. The back wall is divided into two halves by a broad buttress, approximately 0.60 m. wide, projecting 1.60 m. towards the centre. The left section is smaller, but the asymmetrical effect is to a certain extent counterbalanced by a small, rather more than semicircular niche cut in the corner to the left of the entrance: the niche lies on a level with the floor. The roof had collapsed, but its original height could be reconstructed thanks to the preserved section close to the back wall.

STRATIFICATION

The dromos-filling consisted of three layers of horizontally stratified rock material. The uppermost layer contained some stones of the same kinds as those used in the tumulus, and just above the E. end of the dromos, there was a considerable accumulation of such stones. This stratification showed that the tomb was intact, when found.

The chamber contained much extraneous earth, mostly emanating from the partial collapse of the roof. Heavy pieces of rock were found on top of thick layers of *chavara* debris, reaching a maximum thickness of about 1.75 m.

Above the upper stratum of debris some earth from the dromos-filling had intruded, which contained a few sherds: below the main mass of roof debris was a fan-shaped layer of dromos earth. The bottom layer of the chamber consisted of culture earth and burial remains, resting directly on the floor. On each side of the central buttress was found the remains of a body together with its tomb-gifts. There is no evidence for any great difference in time between the two burials, and it seems reasonable to suppose that they were carried out simultaneously, judging by the intact state of the dromos-filling.

BURIALS

There was not very much left of the two skeletons. Of the one in the N. half of the chamber some badly mouldered fragments of the skull were found; six vertebrae, one femur, and two cubital bones. They were, evidently, *in situ*, and are sufficient to reconstruct the original position of the dead body: it was placed lying on the left side, with drawn up legs and bent arms; the head lay towards the centre of the chamber. The other seemed to have been

deposited in a similar way, but with the head towards the back wall. The evidence in the latter case is, however, not very strong.

FINDS (GROUP: PL. LXXI, I; TYPE: L. OF PL. II)

1. Red-on-Black globular jug with round base; widening neck, and an arched handle from neck to shoulder. Horizontal bands of parallel lines around neck and shoulder; bands of vertical lines from neck to base; transverse lines on handle. Paint much worn. Height 19.2. Floor.
2. Red-on-Black shallow bowl with round base; a horizontal handle below rim, and a string-hole at the rim between shanks of handle. Bands of parallel lines from edge to edge crossing the bottom at right angles, both within and without; shorter groups of vertical lines in their interstices. Handle missing; rim chipped. Diam. 15.3. Floor.
3. Red-on-Black miniature jug, as No. 1, but with handle from rim to shoulder. Paint obliterated. Height 7.0. Floor.
4. Red-on-Black large, shallow bowl with round base; short, open spout, and a vertical string-hole projection opposite the spout. Groups of parallel lines, arranged in fringes around edge, and in broad bands from rim to base, both within and without; short, vertical lines in the interstices outside. Incomplete. Diam. 34.0. Floor.
5. Black Slip II globular amphora with round base; wide, concave neck, and two handles from neck to shoulder. Paint worn. Height 25.3. Floor.
6. Plain White Hand-made oval jar with flate base; short, widening neck, and thick rim. A band in relief with impressed zigzag lines around shoulder. Height 56.5. Floor.
7. Red-on-Black depressed, globular jug with distinct shoulder; flat base; cylindrical, wide neck; splaying rim, and an up-turned loop-handle on shoulder. Decorated as No. 1, but without horizontal bands around shoulder; transverse lines on rim. Piece of handle missing. Height 12.6. Floor.
8. Red-on-Black globular amphoriskos with round base; wide, cylindrical neck; splaying rim, and two string-holes through neck. Decorated as No. 1. Height 11.2. Floor.
9. Black Slip II oval jug with round base; concave neck; oblique mouth, and an arched handle from rim to shoulder. Handle missing. Height 7.5. Floor.
10. Red-on-Black bowl, as No. 2, but with contracted rim. Rim chipped; paint much worn. Diam. 17.2. Floor.
11. Red-on-Black oval jug with flattened base; distinct shoulder; wide neck; flat rim; an up-turned, horizontal handle on shoulder, and two projections opposite the handle. A band of horizontal lines around neck, and vertical bands of parallel lines from neck to base. Paint much worn. Height 21.0. Floor.
12. Red-on-Black jug, as No. 1, but with splaying rim. Handle missing; paint much worn. Height 28.5. Floor.
13. Black Slip spherical spindle-whirl. Paint worn. Diam. 4.3. Floor.
14. Black Slip II globular jug with round base; short, concave neck, and an arched handle from rim to shoulder. Rim pierced by a string-hole below handle. Handle missing. Height 14.1. Floor.
15. Red-on-Black bowl, as No. 2, but with a spout opposite the handle. Paint badly worn. Damaged. Diam. 24.2. Floor.
16. Black Slip biconical spindle-whirl. Diam. 4.2. Floor.

The Object Register is summed up in the following diagram: —

		P o t t e r y					Terracotta		
Bl.	Sl. II	Red-on-Black					Pl. Wh.	Spindle-whirls	
5.	9.	1.	2.	3.	4.	7.	6	13.	16
		8.	10.	11.	12.	15			
	-3			-10			-1		-2

CHRONOLOGY

The overwhelming majority of the Red-on-Black Ware is the principle feature of the tomb group. The shapes of the two jugs Nos. 7 and 11 are unusual, and fairly advanced. The tomb might be dated to approximately the middle of Middle Cypriote III.

TUMULUS 5 (Fig. 166: 2, 3; 169)

	SIZE			
	Length	Width	Depth	Height
Tumulus	c. 5.50	c. 4.80	—	c. 0.60
Dromos	2.30	0.73	c. 0.70	—
Chamber	1.45	2.21	—	1.18

SHAPE

The tumulus is low, and consisted almost exclusively of stone. Near the W. edge the dromos of a tomb starts which to a very great extent lies outside the mound. As it is, however, partly covered by it, and the rest of the area below the tumulus only consisted of the crude bed-rock, the close connection of the tomb and the tumulus cannot be considered accidental.

The dromos is a narrow, sloping passage provided with irregular steps, leading down to the chamber: at the upper edge are two excrescences of irregular shape. Close to the entrance of the chamber the dromos is destroyed by the collapse of the stomion. The chamber is small and "kidney-shaped" with horizontal floor, and almost perpendicular sides.

STRATIFICATION

The dromos was filled with stones and *chavara* waste, and the area of the dromos and destroyed stomion were covered by flat stones of irregular shapes forming a pavement running horizontally below the edge of the rock. This pavement must, consequently, have been laid after the stomion was destroyed. The chamber contained a compact filling of rubble, resting on a thin bottom layer of eroded rock material. There was no culture earth, and no finds or burial remains. The rubble is of the same type as that found in the tumulus. There is no reason supporting an hypothesis that the tomb was originally a cenotaph; for a cenotaph must have some tomb-gifts, or show some traces of burial ceremonies, offerings or sacrifices. In this case nothing of that kind was found. It must therefore be supposed that the contents of the tomb have been removed, and the question then arises, when did that happen? As pointed out above, the pavement on top of the dromos must have been laid after the collapse of the stomion, and, as is shown by the section, Fig. 166: 3, the stone-filling in the chamber cannot have been brought in after the pavement was laid. Thus, the tomb having been emptied, the chamber was filled with stones, the dromos with stones and broken *chavara*, and the paving slabs were laid on top. It is clear without further comment, that this procedure cannot have been carried out by tomb-robbers in modern, or comparatively modern, times. The dislocation and the small size of the tumulus have also to be considered: the original position of the tumulus was surely on top of the tomb, and it must, therefore, have been removed in order to reach the tomb, as some of its stones were used for the filling of the chamber. All these particular ceremonies, connected with the plundering of the tomb, indicate that it took place fairly soon after the burial, and that it was made for some special reason. The matter will be discussed later.

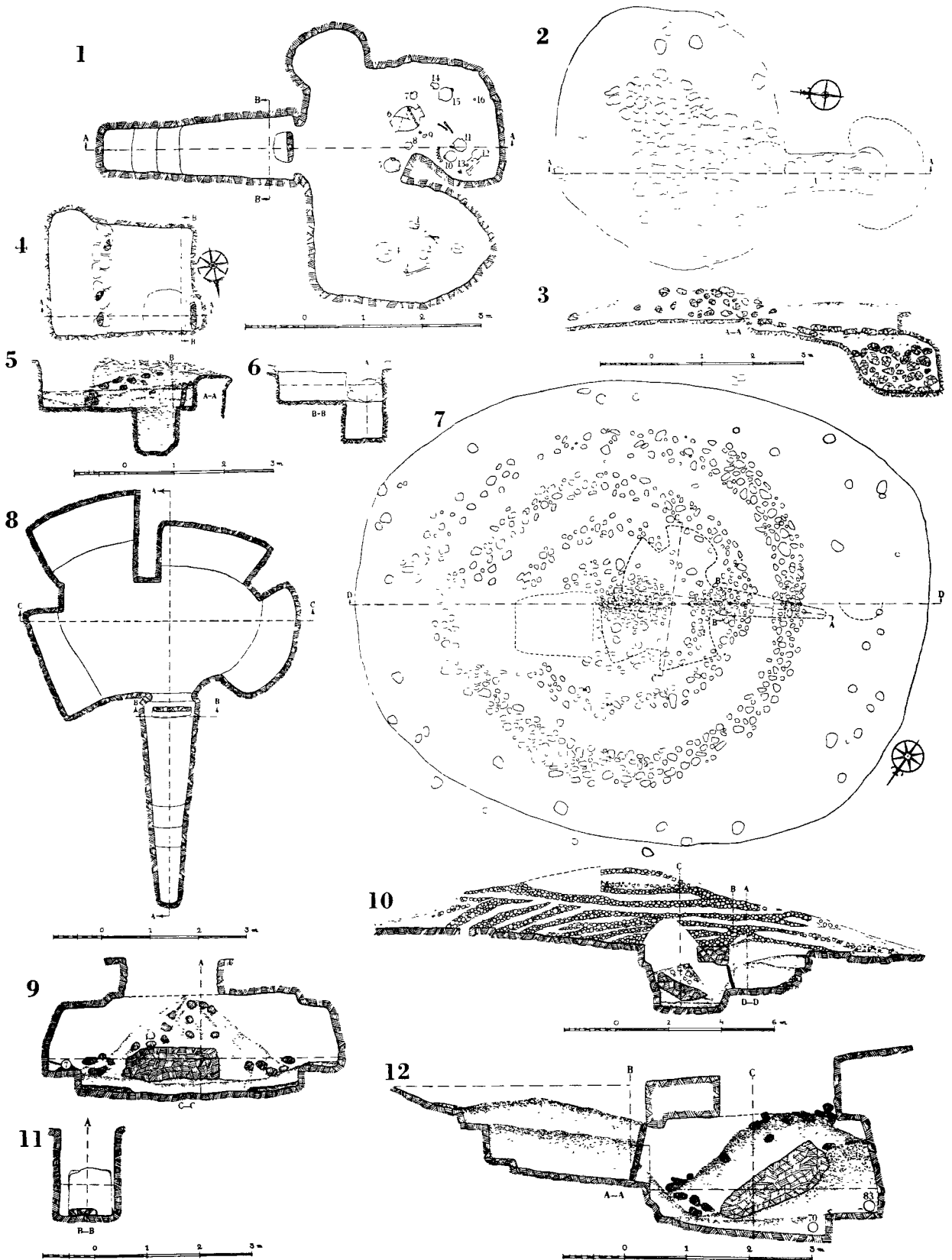

Fig. 166. Paleoskoutella. Tumulus 4, Plan of tomb with finds *in situ* (1). Tumulus 5, Plan (2); Section A-A (3). Tumulus 6, Plan (4); Sections A-A, B-B (5, 6). Tumulus 7, Plan of tumulus (7); Plan of tomb (8); Sections C-C, D-D, B-B, A-A (9, 10, 11, 12).

CHRONOLOGY

The tomb-chamber itself did not contain any sherds, or other chronological criteria. In the dromos-filling, only six sherds were found, four of them being fragments of Red-on-Black Ware bowls and two being of Black Slip II Ware: these are, of course, not enough for an attempt at an exact dating, but indicate certainly, an approximate synchrony with the previous tumuli.

TUMULUS 6 (Fig. 166: 4—6)

SIZE

	Length	Width	Depth
Basin	2.83	2.24	0.94
Pit	0.85	0.83	0.85

SHAPE

This, so-called, tumulus was situated immediately on the W. edge of the top plateau of the hill. The ground slopes considerably, and the rock is partly undermined by gradual weathering, caused by the west winds. It is the lowest point on the plateau, and was therefore exposed also to the destructive effect of the rain. This is the reason for the tumulus being almost destroyed.

What was actually found was only a roughly rectangular basin sunk in the rock to an average depth of 0.90 m. In the N. W. corner was a circular pit cut down to a further depth of 0.85 m. In the same corner, stood an erect slab of local limestone which, seemingly, had served as a cover of the pit. Behind the slab, and in the diagonally opposite corner, are small, apsidal excrescences cut in the sides of the basin. A low wall of rubblestones, only two courses high, was built across the basin running in N. S. direction.

STRATIFICATION

To the E. of the wall was a modern trial pit, apparently dug by tomb-robbers. The intact stratification started on the other side of the wall: on the rock floor lay a horizontal stratum of fine *chavara* covered by two oblique layers of earth, frequently mixed with stones and broken *chavara*. Their oblique formation may indicate the original elevation of the tumulus, and if this holds good, the centre of the tumulus must be reconstructed at a point lying beyond the present edge of the rock. That is, *a priori*, not improbable, as the wind still undermines the precipice, and continually diminishes the area of the top plateau.

The pit was filled with stones and *chavara*: there was no culture earth, or burial remains either in the pit or in the basin, and the shape of the complex has nothing in common with a tomb. On the contrary, there are several similarities to the cult place found below Tumulus 1. There, too, was an rectangular basin with circular pits cut in the rock, but of larger dimensions and a more complicated shape. Taking into consideration the possibility —

or, rather, the likelihood — that the place is only partly preserved, it seems reasonable to suppose that the area excavated below the so-called Tumulus 6 is of the same type as that explored below Tumuli 1 and 3.

CHRONOLOGY

In the intact bottom layer of the basin and in the pit several potsherds were found. An analysis of them is given in the diagram:—

	R. Sl.	Bl. Sl. II	Red-on-Black	Red-on-Red	Pl. Wh.	Coarse Ware	Total
Number of sherds	45	80	56	9	14	4	208
Percentage	21.6 %	38.5 %	27.0 %	4.3 %	6.7 %	1.9 %	100 %

Among the Red Slip Ware are many fragments of bowls with narrow, contracted rims. This advanced shape, the large percentage of Red-on-Black Ware and the absence of Red Polished IV Ware seem to date the tumulus to the later part of Middle Cypriote III.

TUMULUS 7 (Figs. 166: 7—12; 167; 168; 170—173)

SIZE

	Length	Width	Depth	Height
Tumulus	c. 22.00	c. 17.50	—	c. 3.10
Dromos	4.08	1.05	1.62	—
Stomion	0.18	0.80	—	0.90
Chamber	3.47	5.50	—	1.92

SHAPE AND STRATIFICATION OF THE TUMULUS

The large tumulus, which raises its mighty outline on the central area of the top plateau, was investigated at the end of the season. It had been attacked by tomb-robbers who had dug a large pit to a depth of 1.20 m. from the top of the tumulus. What, apparently, made the tomb-robbers stop their digging, was the constant obstruction met with, thanks to the special construction of the mound. This construction was revealed by a broad trench that we dug through the whole tumulus, cutting it into two halves along a line running approximately East and West. Thereby the old trial pit was also dug through.

Before the tumulus was built the rock was levelled to form a roughly horizontal area, and in the centre of this the first heaps of crude rubble-stones were piled up. The system of the construction is made clear by the section, Fig. 166: 10: layers of clayey earth alternate with rubble stones in conical layers all round the tumulus, up to a height of about 1.30 m. On top of all these oblique strata, a horizontal layer of earth was spread and rammed hard, after which follow, in regular alternation, layers of stone and earth, all roughly horizontally laid. The effect of this building method on the plan of the tumulus as seen from above

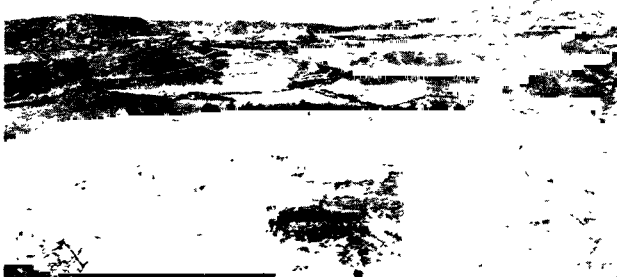

Fig. 167. Paleoskoutella. View of the necropolis from top of Tumulus 7.



Fig. 168. Paleoskoutella. Tumulus 7 before excavation.

is peculiar. The socle is mainly revetted with earth without stone settings, but the upper part gives the impression of having been built with casings of rubble in concentric circles round the top. This alternation of earth and stones made the tumulus very hard to work through, and it was difficult to prevent the sides of the deep trench from falling in. Approximately below the centre of the tumulus, the tomb was found.

SHAPE OF THE TOMB

The dromos is a long, widening corridor with perpendicular sides. It is extremely well cut, and all the angles are very sharp. Three steps, the middle one of which is the highest, lead down to an oblong, sloping area in front of the stomion. The doorway is rectangular in shape, and was closed by a single slab of calcareous stone, fitting neatly into the opening. The stomion is a short passage provided with two steps, leading down to the horizontal floor of the chamber. The plan of the chamber is very elaborate: approximately opposite the entrance is a projecting, parallelepipedic pillar reaching from floor to roof and dividing the chamber into two halves. Each of these halves is provided with two niches raised about 0.40 m. above the floor and separated by regular, projecting buttresses. The roof is flat. In the two niches, on either side of the entrance, the height is slightly less than in the rest of the chamber, and the difference is clearly marked. The stone cutters' work is very exact, and the chamber is remarkably well preserved. Neither the chamber, nor the dromos show any traces of repeated use; they look fresh and their details could have been cut yesterday. The enormous weight of the tumulus above has, however, caused a thorough collapse of the roof just above the centre of the chamber. Around the edges the system of niches has relieved the pressure, and these sections were found in a very good state of preservation.

STRATIFICATION OF THE TOMB

The dromos was filled with three intact, horizontal layers of rock material. Above the stomion was a heap of stones belonging to the tumulus. The stratification showed that the



Fig. 169. Paleoskoutella. Tomb of Tumulus 5.



Fig. 170. Paleoskoutella. The trench through Tumulus 7.

tomb had not been entered after the tumulus was built; that is to say, that the work on the tumulus started after the last burial in the chamber.

On, and below the niches lay find strata and burial remains, directly on the floor and covered by a thin layer of very fine *chavara* dust, which had to some extent intruded through the doorway. Above this lay the debris from the fallen-in roof: it consisted mainly of a large single block, which had, apparently, fallen from a sudden shock, and it may well have been the result of the work of our pick-axes during the early stages of trench digging on top of the chamber: anyhow, the fractures were quite fresh. A considerable mass of the tumulus had followed the roof in the collapse, but the construction of the mound limited the amount of fall (cf. the section Fig. 166: 10). Fortunately the damage caused by the break was not very great, as no bodies or tomb-gifts were deposited in the centre of the chamber. From the stratigraphical point of view, there is no evidence for the relative chronology of the fourteen burials found in the chamber.

BURIALS

In three of the niches lay two skeletons in lateral, contracted positions, and below the niches seven other skeletons were found; one niche was occupied by a single burial only. All had been deposited, as far as could be stated, in the same positions. Two of the skeletons in the niches and three of those on the floor were, however, very fragmentary. A striking feature of the deposit is that no skeleton had been removed in order to make place for another. Also, the fact that two skeletons were placed in each of the three niches is very unusual. As a matter of fact, all the fourteen bodies make the impression of having been brought into the chamber simultaneously.

The bearings of such an hypothesis upon the problems of Tombs 2 and 5 will be discussed in the Concluding Remarks.

FINDS (GROUPS: PLS. LXX, 2; LXXI, 2; LXXII; TYPES: L. OF PL. II)

1. Red-on-Black shallow bowl with round base: contracted rim, and an up-turned, horizontal handle on rim. Groups of parallel lines crossing the bottom at right angles, both within and without; transverse lines on handle. Diam. 12.7. Floor.
2. Black Lustrous Wheel-made oval jug with narrow base-ring; narrow, cylindrical neck; wide funnel-mouth, and handle from rim to shoulder. Height 13.2. Floor.
3. Red-on-Black globular jug with round base; short, concave neck, and handle from neck to shoulder. Groups of roughly parallel, short lines irregularly scattered over the surface. Paint worn. Height 13.1. Floor.
4. Red-on-Black flat, wide bowl with round base; plain rim; small, vertical handle from rim to body, and a spout opposite the handle. Decorated as No. 1, but with groups of short lines hanging from the rim in the interstices of the crossed bands. Diam. 27.2. Floor.
5. Bronze pin with small, flattened head, and an eyelet half way down the shaft. Length 10.4. Floor.
6. Bronze pin, as No. 5. Length 10.4. Floor.
7. Red-on-Black globular jug with round base; concave neck; slightly splaying mouth, and handle from neck to shoulder. Encircling lines around neck; a band of parallel lines around shoulder, and vertical bands from neck to shoulder. Lines on handle. Height 28.5. Floor.
8. Red-on-Black jug, as No. 7, but with handle from rim to shoulder. Horizontal bands of parallel lines around neck and shoulder; vertical bands from neck to base, and narrow, vertical lines from shoulder to base in the interstices of the bands. Height 25.0. Floor.
9. Red-on-Black globular amphora with round base; wide, concave neck, and two handles from neck to shoulder. Horizontal bands of parallel lines around neck and shoulder, and vertical bands of parallel lines from neck to base. Transverse lines on handle. Part of body, and one handle missing. Height 15.8. Floor.
10. Black Slip I globular amphora with round base; cylindrical neck, and two handles from neck to shoulder. Height 20.7. Floor.
11. Fragments of a Black Slip II bowl. Paint obliterated. Floor.
12. Red-on-Black bowl, as No. 4; decorated as No. 1, but with bands of hatched lozenges radiating from centre to rim in the interstices of the bands. Diam. 27.1. Floor.
13. Red-on-Black jug, as No. 7, but with vertical bands from neck to base. Height 34.2. Floor.
14. Black Slip II globular jug with short, concave neck; round base, and handle from neck to shoulder. Damaged. Height 18.0. Floor.
15. Red-on-Black globular jug with flat base; tall, tapering neck; splaying rim, and handle from neck to shoulder. Paint almost obliterated. Height 19.2. Floor.
16. Earring of bronze consisting of a circular ring with overlapping ends on which a spiral is mounted. Diam. 3.2. Floor.
17. Red-on-Black globular jug with round base; concave neck; splaying rim, and an arched handle from rim to shoulder. Horizontal bands of parallel, slightly wavy lines around neck, and similar bands from neck to base. Part of handle missing. Height 13.0. Found inside No. 18.
18. Red-on-Black bowl, as No. 1. Paint much worn. Diam. 13.2. Floor.
19. Red-on-Red globular jug with round base; short, concave neck, and an arched handle from rim to shoulder. Horizontal bands of parallel lines around neck and shoulder; bands of vertical lines from neck to base; similar designs on shoulder; transverse lines on handle. Paint worn. Height 9.7. Floor.
20. Red-on-Black jug, as No. 17. Height 13.4. Floor.
21. Red-on-Black squat amphora with flat base; distinct shoulder; wide, concave neck; splaying rim, and two string-hole projections on shoulder; rim pierced by string-holes. Horizontal bands around neck and belly, and vertical bands from neck to base. Pieces of rim missing. Height 13.0. Floor.
22. Red-on-Black bowl, as No. 1, but with a large loop-handle at rim. Diam. 12.3. Floor.
23. Black Polished spherical spindle-whirl. Paint worn. Diam. 2.3. Found inside No. 24.
24. Red-on-Black bowl, as No. 1. Paint somewhat worn; incomplete. Handle missing. Diam. 16.0. Floor.
25. A pair of bronze earrings, as No. 16. Diam. 3.8. Floor.
26. Plain White Hand-made shallow bowl with round base. Half the bowl missing. Diam. 7.2. Floor.
27. Light-on-Dark globular jug with round base; tall, tapering neck; flaring rim, and handle from rim to shoulder. Decorated as No. 19. Height 30.5. Found in No. 28.
28. Red-on-Black bowl, as No. 1. Paint much worn. Diam. 17.8. Floor.
29. Red-on-Black jug, as No. 15, but with round base. Encircling lines around neck; vertical bands from neck to shoulder; short groups of parallel lines around base of handle, and two hatched lozenges as front ornament. Height 18.4. Floor.
30. Black Slip I amphora, similar to No. 10, but with concave neck, and splaying rim. Height 29.2. Floor.
31. Red-on-Black amphora, as No. 9. A hick, encircling line around shoulder, and broad, vertical lines from rim to base. Height 17.2. Floor.
32. Red-on-Black bowl, as No. 1. Handle and piece of body missing. Diam. 13.3. Floor.
33. Red-on-Red globular jug, as No. 7. Decoration almost obliterated. Height 28.3. Floor.
34. Red-on-Red shallow bowl, as No. 22; decorated as No. 4. Diam. 10.7. Found inside No. 35.

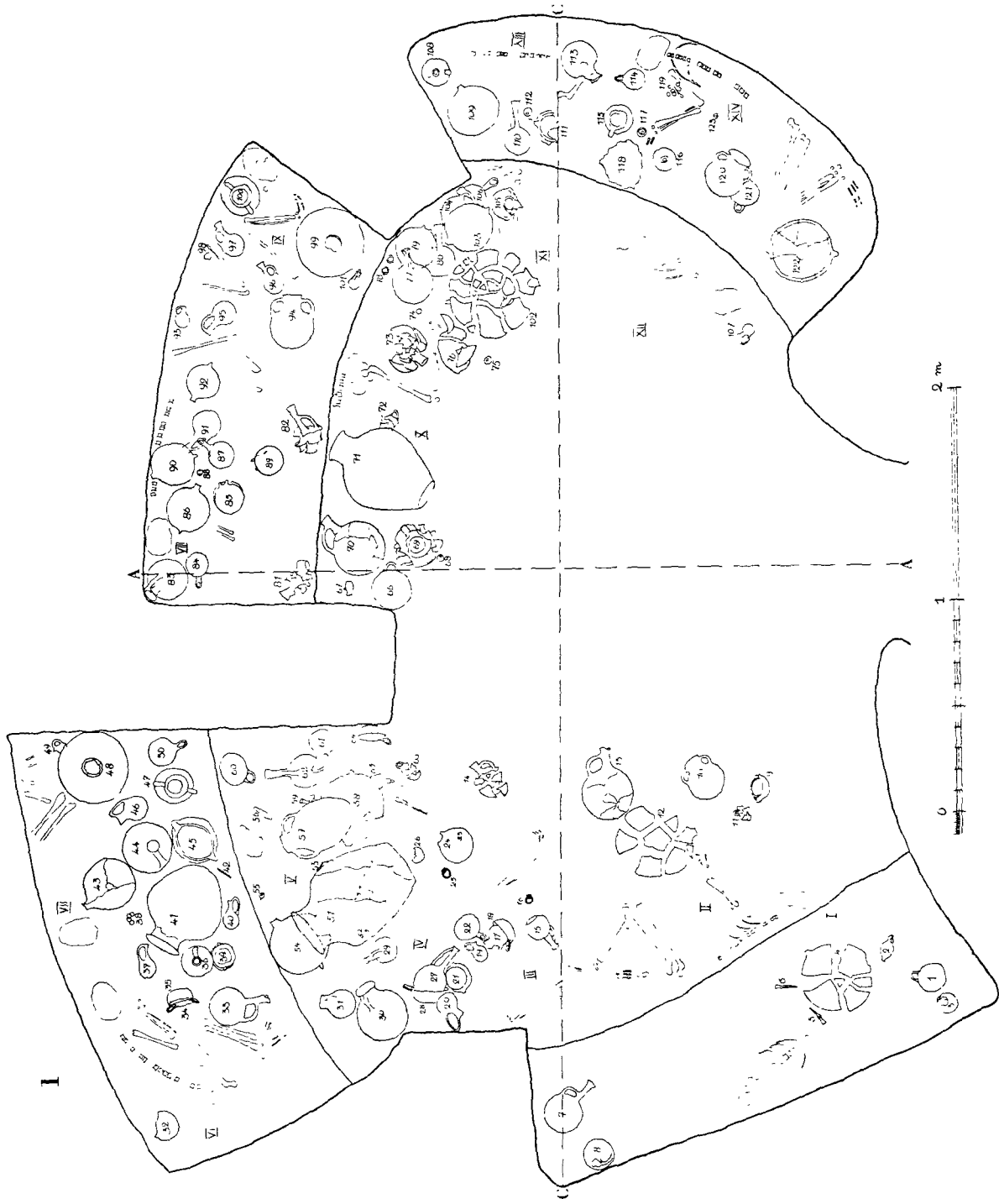

Fig. 171. Paleoskoutella. Chamber of Tumulus 7 with finds *in situ*.

35. Red-on-Red bowl, as No. 1. Diam. 11.2. Floor.
36. Red-on-Black jug, as No. 15. Bands of horizontal lines around neck, and vertical bands from neck to base, crossing the bottom at right angles. Transverse lines on handle. Mouth missing; paint partly worn. Height 21.0. Floor.
37. Red-on-Black globular jug with flat base; narrow, cylindrical neck, and handle from rim to shoulder. Horizontal bands of parallel lines around neck, and bands of vertical lines from neck to base. Transverse lines on handle. Paint much worn. Height 16.2. Floor.
38. A chain of bronze consisting of four, plain rings with overlapping ends. Broken. Floor.
39. Red-on-Black oval amphora with flat base; widening neck; splaying rim pierced by string-holes; two string-hole projections on shoulder. Decorated as No. 21. Height 13.3. Floor.
40. Black Slip II jug with round base; concave neck, and an arched handle from rim to body. Paint obliterated. Height 13.4. Floor.
41. Plain White Wheel-made oval, depressed jar with flat base; concave neck, and flaring rim. Impressed lines around shoulder. Neck damaged. Height 40.3. Floor.
42. Thin, plain bronze pin. Length 7.6. Floor.
43. Red-on-Black bowl, as No. 4; decorated as No. 1. Diam. 24.7. Floor.
44. Red-on-Black jug, as No. 7; decorated as No. 29; paint almost obliterated. Height 33.0. Floor.
45. Plain White Hand-made deep cooking-pot with round base; short, vertical rim, and two handles from rim to shoulder. Height 20.0. Floor.
46. Red-on-Black jug, as No. 17; decorated as No. 37, but with a horizontal band around belly. Height 15.3. Floor.
47. Red-on-Red globular amphora with concave, widening neck, and two handles from neck to shoulder. Horizontal bands of vertical lines around neck, and groups of vertical bands of parallel lines from neck to base. Rim chipped. Height 21.8. Floor.
48. White Painted Wheel-made jar, as No. 41. A double frieze of hatched triangles on shoulder, and vertical stripes from neck to shoulder. Rim missing. Height 33.1. Floor.
49. Black Slip II globular jug with round base; short, concave neck, and an arched handle from rim to shoulder. Paint obliterated. Height 6.1. Floor.
50. Red-on-Black bowl, as No. 22. Diam. 12.4. Floor.
51. Plain White Hand-made oval jar with flat base; concave neck, and profiled, stilted rim. A relief-band around shoulder. Height 56.3. Floor.
52. Black Slip biconical spindle-whirl with incised zigzag lines. Diam. 3.0. Floor.
53. Red-on-Black jug, as No. 15; decorated as No. 36. Pieces missing; paint worn. Height 27.8. Floor.
54. Red-on-Black bowl, as No. 4; decorated as No. 1. Diam. 29.4. Floor.
55. Black Slip spherical spindle-whirl. Diam. 2.4. Floor.
56. Leaf-shaped, double-edged bronze knife with midrib; straight sides, and rounded top with three rivets. Length 10.3. Floor.
57. Black Slip II amphora, as No. 30, but with oblong, ovoid body. Paint much worn. Height 36.3. Floor.
58. Red-on-Black bowl, as No. 4; decorated as No. 1; incomplete. Diam. 32.4. Floor.
59. Fragments of a Black Slip I jug. Paint obliterated. Floor.
60. Red-on-Red bowl, as No. 1. Groups of short, parallel lines scattered over the surface. Transverse lines on handle. Diam. 14.0. Floor.
61. Red-on-Black jug, as No. 8. Horizontal bands of parallel lines around neck and shoulder; vertical bands from neck to base, and zigzag patterns composed of short, vertical lines in their interstices. Transverse lines on handle. Height 20.5. Floor.
62. Red-on-Black jug, as No. 7, but with oval body. Bands of horizontal lines around neck, and vertical bands of parallel lines from neck to base, crossing the bottom at right angles. Transverse lines on handle. Height 27.6. Floor.
63. Red-on-Black jug, as No. 17, but with straight rim, and lower handle. A thick, encircling line around shoulder, and broad, vertical line from rim to base. Height 9.0. Floor.
64. Red-on-Black bowl, as No. 1. Paint worn; incomplete. Diam. 13.5. Floor.
65. Fragments of a Red Slip shallow bowl with round base; contracted rim, and a horizontal handle near the rim. Floor.
66. Red-on-Black bowl, as No. 1. Paint worn; incomplete. Diam. 18.5. Floor.
67. Black Slip II jug, as no 49, but with flat base. Height 6.5. Floor.
68. Black Slip spherical spindle-whirl. Paint worn. Diam. 3.0. Floor.
69. Black Slip I amphora, as No. 30. Paint worn. Height 25.1. Floor.
70. Red-on-Black jug, as No. 13. Incomplete. Height 34.0. Floor.
71. Plain White Hand-made jar, as No. 51, but with a rope-ornament in relief around shoulder. Height 48.4. Floor.
72. Red-on-Red bowl, as No. 1. Incomplete. Diam. 14.7. Floor.
73. Red-on-Black jug, as No. 7. Incomplete. Height c. 31.0. Floor.
74. Thin, plain finger-ring of bronze with overlapping ends. Diam. 2.5. Floor.
75. Red Polished spherical spindle-whirl. Diam. 3.3. Floor.
76. Red-on-Black bowl, as No. 4, but with contracted rim, and horizontal handle; decorated as No. 1, but with radiating bands of fine, transverse lines from centre to rim in the interstices of the vertical bands. Damaged; incomplete. Floor.
77. Red-on-Black jug, as No. 8. Decorated as No. 61,

- but without decorations in the interstices. Paint worn. Height 26.4. Floor.
78. Two plain bronze rings with overlapping ends. Diam. 3.6. Floor.
79. Plain White Hand-made shallow, wide bowl with round base; horizontal handle near the rim, and an open spout opposite the handle. Diam. 19.5. Floor.
80. Red-on-Red globular jug with flat base; distinct shoulder, widening neck, and handle from neck to shoulder. Horizontal bands of parallel lines around neck, and vertical bands of parallel lines from neck to base; transverse lines on handle. Height 24.2. Floor.
81. Red-on-Black oval jug with widening sides; flat base; distinct shoulder; splaying mouth, and handle from neck to shoulder. Decorated as No. 62, but with slightly wavy lines. Height 24.7. Floor.
82. Red-on-Black jug, as No. 7, but with tall, cylindrical neck. Decorated as No. 62. Incomplete. Height 31.2. Floor.
83. Red-on-Red jug, as No. 27. Height 28.3. Floor.
84. Red-on-Black bowl, as No. 22. Paint worn on the outside. Diam. 10.6. Floor.
85. Red Polished IV shallow bowl with round base; contracted rim, and an up-turned, horizontal handle below rim. Handle missing. Diam. 13.2. Floor.
86. Red-on-Black bowl, as No. 4. Diam. 20.3. Floor.
87. Red-on-Black bowl, as No. 22. Diam. 13.0. Floor.
88. Red-on-Black biconical spindle-whirl with zigzag lines on body. Diam. 3.7. Floor.
89. Red-on-Black bowl, as No. 1, but of conical shape, and with plain rim. Diam. 13.5. Floor.
90. Red-on-Red flat bowl with round base; a small, vertical handle below rim, and an open spout approximately opposite the handle. Decorated as No. 4. Diam. 21.6. Floor.
91. Red-on-Black globular jug with round base; distinct shoulder; tall, tapering neck; splaying rim, and handle from rim to shoulder. Height 22.2. Floor.
92. Red-on-Black bowl, as No. 4, but deeper. Irregular groups of parallel, red lines scattered all over the surface. Diam. 15.5. Floor.
93. Red-on-Black jug with round base; short, concave neck; oblique rim, and handle from rim to shoulder. Decorated as No. 3. Paint worn. Height 10.4. Floor.
94. Black Slip I amphora, as No. 30. Paint worn. Height 25.3. Floor.
95. Red-on-Black jug, as No. 8. Horizontal bands of parallel lines around neck, and bands of vertical lines from neck to base. Transverse lines on handle. Paint worn. Height 17.8. Floor.
96. Red-on-Black jug, as No. 82; decorated as No. 13. Height 16.2. Floor.
97. Red-on-Red jug, as No. 7, but with widening neck. Irregular, vertical bands on body; embossed surface. Height 18.1. Floor.
98. Plain bronze ring with overlapping ends. Diam. 3.3. Plain bronze pin with loop-shaped eyelet. Length 7.9. Floor.
99. Plain White Wheel-made jar, as No. 41, but without incised decoration. Incomplete. Height 37.0. Floor.
100. Red-on-Black amphora, as No. 10. Horizontal lines around neck, and vertical bands of parallel lines from neck to base. Transverse lines on handles. Paint worn. Height 20.5. Floor.
101. Plain White Hand-made oval jug with round base; concave neck, and an arched handle from rim to shoulder. Height 8.5. Floor.
102. Red-on-Black bowl, as No. 4, but with fine bands of transverse lines radiating from centre to rim in the interstices of the crossed bands. Diam. 34.3. Floor.
103. Red-on-Black bowl, as No. 4. Paint partly worn; flaws in the clay; incomplete. Diam. 22.0. Floor.
104. Red-on-Red jug, as No. 27. Height 26.7. Floor.
105. Red-on-Black amphora, as No. 31; decorated as No. 100, but with a horizontal band around shoulder. Handle and part of body missing. Height 16.3. Floor.
106. Plain White Hand-made shallow bowl with round base; contracted rim, and a large loop-handle below rim. Diam. 12.7. Floor.
107. Red-on-Black jug, as No. 63; decorated as No. 46. Height 8.7. Floor.
108. Red-on-Black jug, as No. 80; decorated as No. 62. Neck missing. Height 18.0. Floor.
109. Red-on-Black bowl, as No. 4. Flaws in the clay. Diam. 24.8. Floor.
110. Red-on-Black jug, as No. 82; decorated as No. 62. Height 25.1. Floor.
111. Wide crater of Coarse Ware with round base; out-turned rim, and two handles from rim to shoulder. Half the vase missing. Diam. 14.0. Floor.
112. Black Slip spherical spindle-whirl. Diam. 3.7. Floor.
113. Black Slip I amphora, as No. 10. Paint worn. Height 21.7. Floor.
114. Red-on-Black bowl, as No. 1. Paint worn. Diam. 10.0. Floor.
115. Red-on-Black jug, as No. 63; decorated as No. 46. Height 17.0. Floor.
116. Plain White Hand-made depressed jug with flat base; cylindrical neck; flaring rim, and two string-holes through neck. No handle; base partly missing. Height 13.1. Floor.
117. Red-on-Black jug, as No. 17; decorated as No. 95. Paint worn. Height 6.0. Floor.
118. Piece of gypsum plaster, used for repairing a large vase with round base. Length 21.8. Floor.
119. Bronze fragments of various shapes; badly corroded. Floor.
120. Black Slip I amphora, as No. 30. Paint worn. Height 21.5. Floor.
121. Red-on-Red bowl, as No. 1; decorated as No. 4. Diam. 13.4. Floor.
122. Plain White Hand-made wide bowl with flat base; straight sides; flat rim, and two handles from rim to body. Diam. 29.8. Floor.
123. Biconical spindle-whirl of lead. Length 2.0. Floor.

To complete the description of the finds there should be a short summary of the main features of the potsherds found in the tumulus. The principle features are the large percentage of Red-on-Black Ware; the fine specimens of Red-on-Red and Dark-on-Light Wares; Plain White Hand-made Ware and Black Slip II Ware. These formed the bulk of the sherds, but also the wheel-made wares were remarkably frequent: Red Slip; Black Slip; White Painted; Bichrome, and Plain White Wares were represented. A small selection of the more than 5,000 sherds is given on Pl. LXX, 2.

Summing up the Object Register and classifying the finds, we obtain the following diagram: —

Pottery																				Lead	Bronze				Terra-cotta	Gypsum plaster
Hand-made										Wheel-made																
R. Pol. IV	Red Sl.	Bl. Sl. I	Bl. Sl. II	Red-on-Black				Red-on-Red	Light-on-Dark	Pl. Wh.	Coarse Ware	Black Lustr.	Wh. P.	Pl. Wh.	Spindle-whirl	Knife	Pins	Rings	Chain	Fragments	Spindle-whirls					
85	65	10	11	1	3	4	7	8	19	27	26	111	2	48	41	123	56	5	16	38	119	23	118			
		30	14	9	12	13	15	17	33		45				99		6	25				52				
		59	40	18	20	21	22	24	34		51						42	25				55				
		69	49	28	29	31	32	36	35		71						74	78				68				
		94	57	37	39	43	44	46	47		79						98	78				75				
		113	67	50	53	54	58	61	60		101							98				88				
		120		62	63	64	66	70	72		106											112				
				73	76	77	81	82	80		116															
				84	86	87	89	91	83		122															
				92	93	95	96	100	90																	
				102	103	105	107	108	97																	
				109	110	114	115	117	104																	
									121																	
-1	-1	-7	-6						-60		-13	-1	-9	-1	-1	-1	-2	-1	-1	-5	-6	-1	-1	-7	-1	

CHRONOLOGY

The chief features of the contents of the tomb are the same as those traceable in the statistics of sherds from all the tumuli. The Black-on-Red Ware is found in an overwhelming majority flanked on one side by the Red-on-Red, and on the other, by the Black Slip Wares. The Red Slip bowl is only fragmentary, but its shape is very advanced and reminds one of the early Monochrome bowls. The Light-on-Dark jug is an exquisite and unique specimen. Of the imported wares, the White Painted jar is worth mentioning. The Black Lustrous jug also emphasizes the relatively late date. The whole group certainly contains some early and some late specimens, the latest of which date the closing of the tomb to the end of the Middle Cypriote III period, and the erection of the tumulus is thereby dated, too.



Fig. 172. Tumulus 7. Chamber with finds *in situ*.



Fig. 173. Tumulus 7. Tomb seen towards the dromos.

CONCLUDING REMARKS

Apart from the extraordinary shape of necropolis and tombs, the extensive cult of the dead, and the characteristic contents of the tombs, which have all been treated above, there remain some points that should be considered here.

In the first place, the complete abandoning and desecration of the cult places found below Tumuli 1, 3, and 6 (cf. above pp. 419, 423, and 428): the votive gifts have been taken away, and the sacred places have been covered over not only by thick layers of white clayey earth and rock matter, but also hidden below mounds of stones of the same type as those found on top of the tombs. This marks an abrupt cessation of the cult, which was never again taken up. To judge from the potsherds found on the floors of the respective sites, this happened at the very end of Middle Cypriote III.

Secondly, there is the emptying of Tombs 2 and 5. It has been shown above (pp. 422 and 426), that strong reasons speak for dating these events to a time not long after the burials took place. These could be dated to the middle of Middle Cypriote III, and therefore the actual emptying of the chambers seem to be contemporary with the desecration of the cult places.

Finally, we have the intact burials in the large tumulus. The tomb-gifts show a slightly heterogeneous collection of late and early specimens, but as the position in the tomb postulates a contemporary burial of all the bodies, the latest finds date the whole burial. This took place at the end of Middle Cypriote III, and thereafter the large mound was built up. The sherds found in the trench agree with this dating.

Can these three events be related in some way with one another, other than their apparent synchrony? No tombs, not even a single sherd, datable to the Late Cypriote times, were found in the necropolis; also the cult places were abandoned before that time. This is, of course, sure proof that the place ceased to be used as a burial ground at the end of

Middle Cypriote III, but does not, however, explain the minute desecrations and the emptying of the smaller tumuli. In connection with the latter, another question arises: where are the skeletal remains of the bodies buried in these tombs? To my mind, it is inevitable to connect the heterogeneous burial of the large tumulus with the emptying of the smaller tombs, viz., their contents have been brought over to a common resting place below the central tumulus. Several of the burial remains in Tomb 7 give also the impression of having been brought into the chamber as mouldered corpses, or perhaps only as skeletal remains. This is the case, especially, with three of the bodies on the floor, which, had we to deal with successive burials, ought to have been the latest, and best preserved. The final proof would be given, if some potsherds from the smaller tumuli fitted into pots, or fragments from Tumulus 7. That, however, could not be stated definitely, but one of the Plain White fragments found in Tomb 2 was, evidently, part of the same jar as one sherd found in the main trench dug through Tumulus 7. This fact is of some conclusive value, and the hypothesis can be considered proved (see Pl. LXX, 2).

Only the largest of the minor tumuli (T. 4) was left intact. The dead, buried there, rested safe below the intact mound.

All this extensive ceremonial, carried out before the place ceased to be used as burial ground is difficult to understand, without supposing that the people who used it, left their dwelling-places as well as the region, and that they made their sacred burial ground safe from the violation of the coming foreigners and invaders. What connection these events have with the history and development of the neighbouring Fortress of Nitovikla will be studied further on.

E. S.

KOUNTOURA TRACHONIA

The Necropolis

INTRODUCTION

When walking along the shepherds' paths by the rocky shore, east of the Fortress of Nitovikla, one comes, after a mile or so, upon the hilly forest land of Kountoura Trachonia. It is bordered, on one side, by one of the many flat-topped, bare hills so typical for the landscape of eastern Carpass, and from its foot the wooded slope sinks gradually to the sea-shore. Our attention was first drawn to the place by some cave-tombs, cut in the steep rock wall overlooking the lower part of the burial ground. They are clearly visible from a distance, and are now used by the shepherds as occasional shelter from the winter rains. In the forest below there were many traces of clandestine excavations; more than a dozen tombs had been opened and emptied of their contents, and heaps of potsherds from Cypro-Classic to Hellenistic times could be picked up on the ground. Eight of the tombs showed unusual features: dromos and chamber are mainly of the ordinary type, but the tombs were covered by low mounds of earth, lined by upright stone slabs. Unfortunately these tumuli and stone linings had also attracted the attention of the modern tomb-robbers, and no intact tombs of that type were found: Tomb 15 (see p. 459) is a good specimen of the average type. Fourteen intact tombs without tumuli were found. The tombs of the two types were not separated on the site, and the tumuli lay here and there among the ordinary tombs. According to the reports of the peasants in the neighbouring villages none of the secretly excavated tombs were very rich.

TOMB 1 (Fig. 176: 1—3)

SIZE

	Length	Width	Depth	Height
Dromos	1.13	0.91	0.45	—
Chamber	0.38	0.60	—	0.45

SHAPE AND STRATIFICATION

The tomb is of miniature size and consists of a shallow, oval dromos with rounded corners and a flat floor, and a small oblong chamber on 0.12 m. lower level. The

entrance was closed by a slab of local limestone. The dromos was filled with two layers of intact *chavara* material, and in the chamber lay the badly mouldered remains of a child's skeleton covered by a small layer of debris from the roof. No tomb-gifts were found in the chamber.

TOMB 2 (Figs. 174; 176: 4—7)

	SIZE			
	Length	Width	Depth	Height
Dromos	3.10	1.50	1.28	—
Stomion	0.26	0.81	—	0.85
Chamber	1.83	2.27	—	1.00

SHAPE

The dromos is a shallow basin, widening towards the entrance of the chamber. It is provided with four steps at the narrow end which lead down to a flat, rectangular area in front of the stomion. The walls are perpendicular, and the whole dromos is carefully cut. The entrance was closed by an upright slab of local limestone, wedged with some small stones and chips. Round the door stone the rock was somewhat worn.

The stomion is a short, slightly sloping passage, and the chamber is a roughly square room with horizontal floor, vertical walls, and flat roof.

STRATIFICATION

The dromos-filling consisted, except for the two surface layers, of three strata of rock material. The two lower strata were approximately horizontal, but their front sections were cut through by the loose, obliquely stratified top layer. This circumstance indicates that the chamber has been reused for secondary burials, for which the dromos was only partly excavated. In the chamber were found two strata of debris from stomion and roof, covering the find stratum. The latter rested on a thick bed of sand. All the finds and the skeletal remains lay on roughly the same level. To the small differences no special significance can be attributed, as the maximum variation was 0.05 m.

An attempt to establish a relative chronology of the contents in spite of the lack of stratigraphical evidence, can be carried out, thanks to the special disposition of the skeletal remains, and the grouping of the deposit. To the right of the door were found two skeletons which, apparently, were not *in situ*. They clearly represent an earlier stage, and have been removed together with their gifts when the chamber was reused. The deposit belonging to them consists of the finds Nos. 1—17 and 32—33 and a bowl found in the bottom layer of the dromos. The rest of the tomb-gifts, i. e., Nos. 18—31 and 34—35 belong to two skeletons *in situ* near the opposite wall. There also was found the skull of a third skeleton which belongs to the earlier stage.



Fig. 174. Kountoura Trachonia. Tomb 2, dromos.



Fig. 175. Kountoura Trachonia. Tomb 8, dromos.

BURIALS

The burial customs are revealed by the two latest skeletons found *in situ*. They were lying in dorsal, outstretched positions surrounded by their tomb-gifts. Their heads lay towards the door, and a lamp was placed immediately inside the door. In both burial periods coins were used as tomb-gifts, but they were not found in immediate connection with the dead bodies.

FINDS (GROUP: PL. LXXIII, I; TYPES: L. OF PL. II)

C h a m b e r

1. Black Lustrous sack-shaped jug with flat base; thick, splaying rim, and handle from rim to shoulder. Height 12.2. — 53.
2. Plain White sack-shaped jug with flat base; distinctly splaying rim, and handle from rim to shoulder. Height 15.7. — 53.
3. Bronze coin; much corroded; illegible. Diam. 1.5. Weight 3.03. Floor.
4. Bronze coin; much corroded; illegible. Diam. 1.4. Weight 2.80. Floor.
5. Bronze coin; much corroded; illegible. Diam. 2.4. Weight 8.30. Floor.
6. Plain White jug, as No. 2. Height 18.5. — 53.
7. Black Lustrous wide, pear-shaped jug with flat base, concave neck, splaying rim, and handle from rim to body. Height 8.3. — 54.
8. Black Lustrous tear-bottle with narrow neck and base, and ovoid body. Height 10.8. Found on top of No. 8.
9. Plain White depressed jug with base-ring; tall, cylindrical neck; narrow, pinched mouth, and handle from rim to shoulder. Height 16.8. — 53.
10. Plain White jug, as No. 8. Height 18.9. — 52.
11. Plain White squat jug with base-ring; narrow, cylindrical neck; convex collar-rim, and handle from neck to shoulder. Height 19.3. Found inside No. 11.
12. Painted Black Lustrous kantharos with two upright, vertical handles. A wreath of leaves painted in white around body. Incomplete; paint worn. Height 12.2. — 56.

12. Plain White conical, sack-shaped jug with base-ring: splaying rim, and handle from rim to shoulder. Height 16.0. Found on top of Nos. 13 and 14.
13. Plain White jug, as No. 8, but with a ridge below neck. Height 22.8. — 53.
14. Plain White jug, as No. 8. Height 17.6. — 53.
15. Plain White jug, as No. 8. Height 18.9. — 54.
16. Plain White jug, as No. 10, but with biconical, stitted rim. Height 16.2. — 54.
17. White Painted biconical jug with base-ring; short, concave neck; convex, pinched mouth, and handle from rim to shoulder. Red, encircling lines around shoulder; vertical, leaf-shaped stripes around neck, and a front ornament of two leaves opposite the handle. Height 18.5. — 56.
18. Black Lustrous jug, as No. 1. Handle missing; rim chipped. Height 16.0. — 52.
19. Black Lustrous jug, as No. 1. Height 18.9. — 51.
20. Black Lustrous jug, as No. 1. Height 17.3. — 51.
21. Black Lustrous flat bowl with base-ring, and in-bent rim. Diam. 13.7. — 53.
22. Black Lustrous bowl, as No. 21. Diam. 13.3. — 55.
23. Plain White jug, as No. 10, but with short, concave neck. Height 18.1. — 51.
24. Plain White depressed jug with flat base; widening neck; in-bent rim, and handle from rim to shoulder. Height 16.2. — 53.
25. Plain White jug with profiled outline; distinct shoulder; cylindrical neck; concave, thick rim, and handle from neck to shoulder. A ridge around neck. Height 19.3. — 55.
26. Plain White jug, as No. 8, but with short, conical neck, and a long, pinched mouth. Height 18.7. — 52.
27. Black Lustrous biconical jug with narrow base-ring; large, concave neck: splaying mouth; in-bent rim, and handle from top of neck to shoulder. Height 11.5. — 56.
28. Plain White jug, as No. 26. Height 17.4. — 52.
29. Plain White jug, as No. 8. Height 15.2. — 54.
30. Black Lustrous biconical jug with base-ring. Neck and handle missing. Height 10.3. — 54.
31. Flat, trefoil-shaped lamp of terracotta with base-ring, and flaring rim. Diam. 9.5. — 53.
32. Plain White pear-shaped jug with concave neck, in-bent rim, and vertical handle on shoulder. Height 8.0. — 56.
33. Plain White jug, as No. 8. Height 14.4. — 54.
34. Bronze coin. *Obverse*: Head of Ptolemaeus II in right profile; wearing taenia. *Reverse*: Eagle facing left; sitting on a thunderbolt with wings open. Worn on both sides. Diam. 1.8. Weight 4.30. — 55.
35. White Painted oval jug with flat base; short, narrow neck; convex, pinched mouth, and handle from rim to shoulder. Encircling lines around rim and neck; broad, vertical stripes from neck to base; narrow, horizontal lines on the front side, and a wavy line on handle. Height 9.8. — 54.

Dromos

1. Plain White shallow bowl with base-ring, and rounded outline. Diam. 13.0.

A summary of the Object Register and a distribution of the finds between the two burial groups, gives the following diagram:—

	P o t t e r y				Bronze	Terracotta
	Pl. Wh.	Wh. P.	Bl. Lustrous	Painted Bl. Lustr.	Coins	Lamp
1st group	2. 5. 8. 9 10. 12. 13. 14 15. 16. 32. 33 -12	17 -1	1. 6. 7 -3	11 -1	2. 3. 4 -3	
2nd group	23. 24. 25. 26 28. 29 -6	35 -1	18. 19. 20 21. 22. 27 30 -7		34 -1	31 -1
Dromos	1 -1					

TOMB 3 (Fig. 176: 8—10)

SIZE

	Length	Width	Depth	Height
Dromos	3.06	1.27	1.57	—
Stomion	0.23	0.83	—	c. 0.75
Chamber	1.60	1.42	—	c. 0.95

SHAPE

The dromos is of essentially the same type as that of Tomb 2, but because of the loose consistency of the rock, the floor and the façade are defaced. The steps in the narrow end are all obliterated, and the stomion has been enlarged by a partial collapse of the roof. In front of the doorway is a small, trapezoid area sunk down to a level of 0.08 m. below the main floor of the dromos. The door-packing consisted of a large irregular block of local limestone, flanked by some smaller pieces of the same material. The stomion is short and wide, and slopes down to the horizontal floor of the chamber. The chamber is of a regular and symmetrical shape with angular corners towards the doorway; parallel sides, and an apsidal back wall. The roof had fallen to a great extent, but could be reconstructed as having been almost flat.

STRATIFICATION

The dromos was filled with *chavara* stratified in three horizontal layers. The two, lower strata were of slightly coarser consistency. The tiny culture layer of the chamber was covered by a heavy mass of debris fallen from roof and stomion. There were traces of two burials; the earlier one represented by a disturbed layer of dark earth and fragments of bones, the later by a skeleton along the right wall. To this belong, apparently, Finds Nos. 1—8; and to the earlier stage, Finds Nos. 9—16. All the finds were found on the floor, an indication that the difference in time between the two groups cannot be very great.

BURIALS

Of the later skeleton only the femora, the skull, and one tibia were left. They show that the dead body was placed in dorsal, outstretched position with the head towards the door.

FINDS (GROUP: PL. LXXIII, 2; TYPES: L. OF PL. II)

- | | |
|--|---|
| <ol style="list-style-type: none"> 1. Plain White depressed jug with base-ring; narrow, cylindrical neck; convex rim: pointed, pinched mouth, and handle from rim to shoulder. A ridge around neck. Height 19.0. — 134. 2. Plain White sack-shaped jug with base-ring; concave neck; splaying rim, and handle from rim to shoulder. Height 15.2. Found on top of No. 3. 3. Plain White shallow bowl with base-ring; curved outline, and splaying rim. Diam. 13.2. Floor. 4. Plain White jug, as No. 1, but without ridge, and with a twin-handle from rim to shoulder. Height 15.2. Floor. 5. Plain White jug, as No. 2. Height 18.0. Floor. 6. Plain White bowl, as No. 3. Rim chipped. Diam. 13.1. Floor. 7. Black-on-Red shallow bowl with base-ring, and horizontal rim. Red inside; black rim, and mottled outside. Diam. 16.0. Floor. 8. Plain White jug, as No. 1, but with biconical body. Pink surface; incomplete. Height 24.7. Floor. | <ol style="list-style-type: none"> 9. Plain White jug, as No. 4. Piece of body missing. Height 18.6. Floor. 10. Plain White large, oval amphora with base-ring; conically widening neck; stilted rim, and two horizontal handles on shoulder. The amphora was covered with a plain plate. Height 51.2. Floor. 11. Depressed jug of Coarse Ware with flat base; slightly concave, wide neck, and a handle from rim to shoulder. Height 9.9. Floor. 12. Plain White jug, as No. 4. Pieces of body missing. Height 22.3. Floor. 13. Trefoil-shaped, open lamp of terracotta with flattened base, and flaring rim. Diam. 11.6. Floor. 14. Plain White jug, as No. 4. Height 13.1. Floor. 15. Plain White jug, as No. 4. Height 15.1. Found on top of No. 16. 16. Plain White bowl, as No. 3, but with higher rim, and more angular outline. Rim chipped. Diam. 12.4. Floor. |
|--|---|

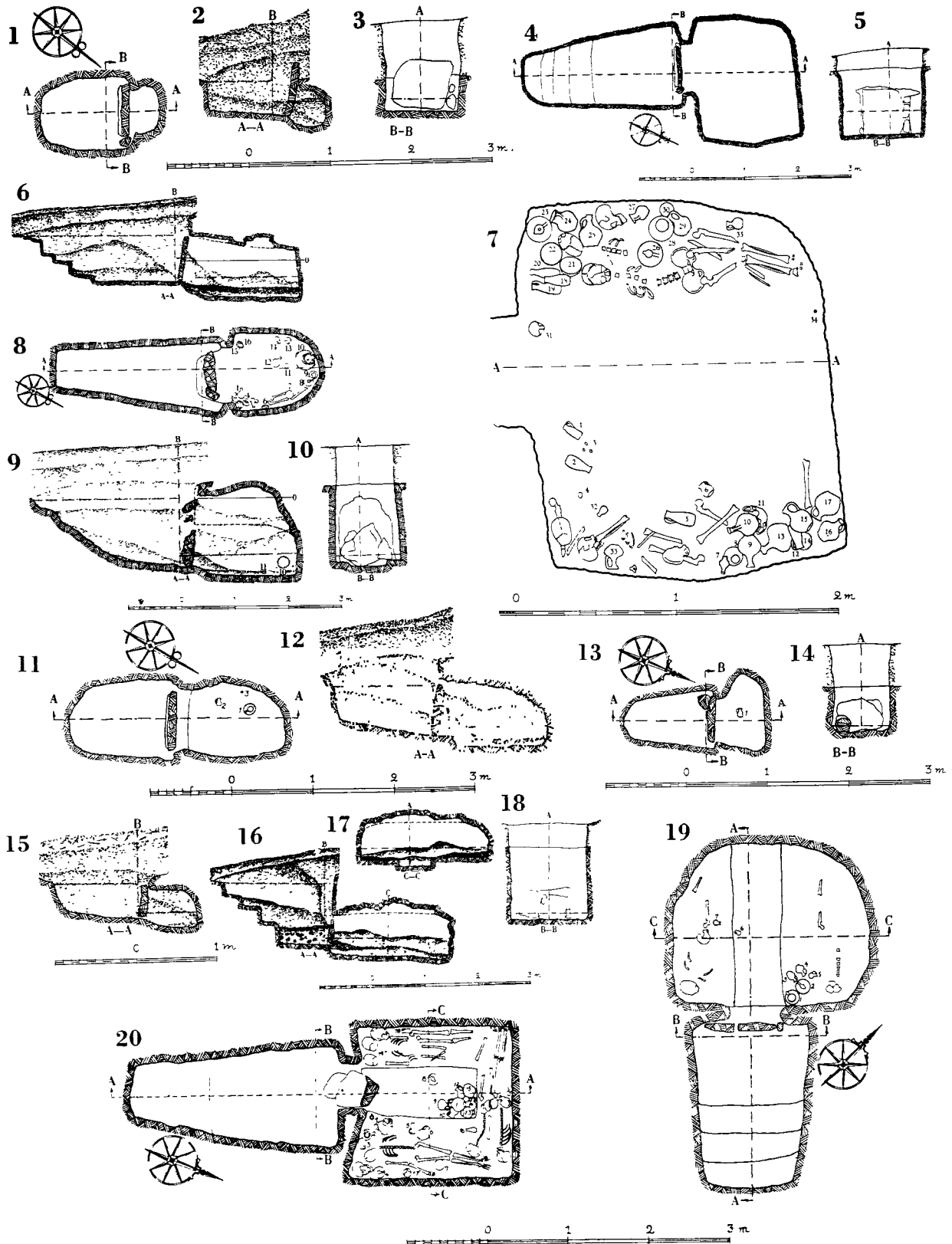

Fig. 176. Kountoura Trachonia. Tomb 1, Plan (1); Sections A-A, B-B (2, 3). Tomb 2, Plan (4); Sections B-B, A-A (5, 6); Finds *in situ* (7). Tomb 3, Plan (8); Sections A-A, B-B (9, 10). Tomb 4, Plan (11); Section A-A (12). Tomb 5, Plan (13); Sections B-B, A-A (14, 15). Tomb 6, Sections A-A, C-C, B-B (16, 17, 18); Plan (19). Tomb 7, Plan (20).

Summing up the Object Register and distributing the finds between the two groups we obtain the following diagram: —

	P o t t e r y			Terracotta
	Pl. Wh.	Bl.-on-R.	Coarse Ware	Lamp
1st group	9, 10, 12, 14 15, 16 -6		11 -1	13 -1
2nd group	1, 2, 3, 4, 5 6, 8 -7	7 -1		

TOMB 4 (Fig. 176: 11—12)

SIZE

	Length	Width	Depth	Height
Dromos	1.34	0.98	0.94	—
Stomion	0.18	0.71	—	0.70
Chamber	1.20	0.93	—	0.80

SHAPE AND STRATIFICATION

Both the shape and stratification of this tomb closely resemble Tomb 1: the miniature size, the intact filling of *chavara* material and debris, and the fragmentary remains of a child's skeleton in the chamber. Here the body was accompanied by three tomb-gifts.

FINDS (PL. LXXIII, 3)

1. Oval jug of Coarse Ware with flat base; short, wide neck, and handle from rim to shoulder. Height 14.8. Floor. neck; pinched mouth, and handle from rim to shoulder. Height 9.8. Floor.
2. Plain White sack-shaped jug with flattened base; concave
3. Spiral ring of bronze. Diam. 1.9. Floor.

The Object Register is summed up in the diagram: —

	P o t t e r y		Bronze
	Pl. Wh.	Coarse Ware	Ring
	2 -1	1 -1	3 -1

TOMB 5 (Fig. 176: 13—15)

SIZE

	Length	Width	Depth	Height
Dromos	1.14	0.71	0.57	—
Chamber	0.58	0.90	—	0.43

SHAPE AND STRATIFICATION

This tomb, too, is in all essential details a replica of Tomb. 1. The filling of dromos and chamber are intact debris and rock material. Traces of a child's burial together with a miniature pot were found on the floor.

FIND (PL. LXXIII, 4)

1. Plain White sack-shaped jug with flattened base, concave neck, pinched mouth, and handle from rim to shoulder. Height 11.7. Floor.

TOMB 6 (Fig. 176: 16—19)

SIZE

	Length	Width	Depth	Height
Dromos	2.15	1.45	1.37	—
Stomion	0.22	0.61	—	0.57
Chamber	1.98	2.42	—	c. 0.80

SHAPE

The dromos is an almost rectangular basin of a comparatively great width, and provided with four very regular steps in the further end. They lead down to a rectangular, horizontal area in front of the stomion. The sides of the dromos are perpendicular, except for the façade which is somewhat worn. The doorway was closed by two equally large stone slabs and a few wedging stones. The stomion leads by means of a low step down to the deeper section of the chamber floor. The chamber is roughly circular in shape with almost perpendicular sides and a low, flat roof. In the prolongation of the stomion runs a channel-shaped groove dividing the chamber into two halves, like two low shelves or ledges. The left ledge is narrower than the right one.

STRATIFICATION

The dromos was filled with broken *chavara* increasing in hardness towards the bottom. The bottom layer which started from the level of the last step in the dromos contained many chips of stone. Just in front of the door there was a dark, vertical layer of moist earth, apparently the deposit from intruding water. It has followed the rock-cut face from the surface down to the entrance of the stomion, and seems to be the reason for the erosion of the rock in this section of the dromos.

On the benches of the chamber lay two bodies surrounded by their tomb-gifts. They were covered by a thin layer of rock debris, and in the central groove lay a sterile stratum of sand and *chavara*, and some dromos-filling which had poured in through the door-packing. There is neither stratigraphical, nor other evidence for fixing the relative chronology of the two burials, as both were found intact and have been deposited independently of each other. As a matter of fact, it is not probable that the difference in time between them was very great, and their state of preservation seems rather to imply an approximate synchrony.

BURIALS

There were only a few fragments of the two skeletons left, but the remains were still significant enough to assume a reconstruction of the original positions of the dead bodies. They were both placed in outstretched, dorsal positions with the heads towards the door of the chamber.

FINDS (PL. LXXIII, 5)

- | | |
|---|--|
| 1. Biconical jug of Coarse Ware with flat base; wide, concave neck, and handle from rim to shoulder. Height 19.5. Floor.
2. Plain White depressed jug with base-ring; narrow, concave neck; pointed, pinched mouth, and handle from rim to shoulder. Height 24.5. Floor.
3. Plain White jug, as No. 2. Height 14.8. Floor.
4. Plain White jug, as No. 2. Height 15.7. Floor. | 5. Plain White jug, as No. 2. Height 10.5. Floor.
6. Plain White pear-shaped jug with flat base; narrow, cylindrical neck; thick collar-rim, and handle from neck to shoulder. Height 8.0. Floor.
7. Plain White depressed jug with flat base; short, tapering neck; wide, horizontal rim, and handle from rim to shoulder. Height 7.5. Floor. |
|---|--|

A summary of the Object Register is given here below:—

Pl. Wh.	Coarse Ware
2, 3, 4, 5, 6, 7	1
-6	-1

TOMB 7 (Figs. 175; 176: 20; 177; 179: 1—3)

SIZE

	Length	Width	Depth	Height
Dromos	2.54	1.23	1.26	—
Stomion	0.30	0.54	—	0.84
Chamber	1.85	1.89	—	c. 1.00

SHAPE

The dromos of the usual type, is well cut, and provided with three steps at the further end. The area in front of the dromos is rather large, and its floor is perfectly horizontal. The door stone was found leaning inwards into the stomion, which is a narrow passage, leading by means of two steps down into the deep, central section of the chamber. The chamber is square, its sides are vertical and the roof is shaped like a flat barrel-vault. Inside the stomion is a rectangular, sunken area surrounded by ledges on three sides. The corners of the front wall project towards the dromos forming acute angles with the longitudinal side walls.

STRATIFICATION

The dromos was filled with intact layers of rock material. In front of the stomion, the roots of a "*schinia*" bush have broken through the filling. They have drawn the rain-water into the stomion, and it seems probable that this is the reason why the door stone was found fallen forward. Their tight network has, however, prevented the dromos-filling from intruding into the chamber to any great extent.

The chamber contained eight skeletons, two near the back wall, and three near each of the side walls. A large number of the tomb-gifts were found in a common deposit in the central hollow, and the rest was placed in the immediate neighbourhood of their respective bodies. There is small evidence for establishing a chronological sequence between the finds; it can be stated that the pots Nos. 4, 7, and 17 have been brought into the chamber earlier than the rest of the finds on the same ledge, but that is not enough for a distinct grouping of the contents.

BURIALS

The skeletal remains were all fairly well preserved, and there could be no doubt about their original positions. All have been buried in dorsal, outstretched positions. The six bodies found near the side walls lay parallel with their heads towards the entrance, and the two near the back wall in a similar position with their heads in an eastern direction. A small lamp and some coins — the latter found in close connection with one of the skulls — were found among the tomb-gifts.

FINDS (GROUP: PL. LXXIV, I; TYPES: L. OF PL. II)

- | | |
|--|--|
| <p>1. Plain White sack-shaped jug with flat base; thick, stilted, rim, and handle from rim to shoulder. Height 10.6. Floor.</p> <p>2. Oval jug of Coarse Ware with flat base; bulging neck, and handle from rim to shoulder. Height 17.3. Floor.</p> <p>3. Plain White depressed, globular jug with base-ring; convex neck; collar-rim, and twin-handle from neck to shoulder. Height 12.7. Floor.</p> <p>4. Plain White biconical jug with base-ring; tapering neck; pinched mouth, and handle from rim to shoulder. Height 16.5. Floor.</p> <p>5. Plain White sack-shaped jug with flat base; narrow neck; pinched mouth, and a handle from rim to shoulder. Height 13.8. Floor.</p> <p>6. Plain White jug, as No. 4. Height 18.0. Floor.</p> <p>7. Plain White shallow bowl with base-ring; curved sides, and splaying rim. Diam. 12.6. Floor.</p> <p>8. White Painted squat, biconical jug with base-ring; tapering neck; collar-rim, and handle from neck to shoulder. Encircling lines around rim, neck, and belly; crossed lines on handle. Paint worn. Height 16.8. Floor.</p> | <p>9. Plain White jug, as No. 8, but with shorter neck, and pinched rim. Height 12.5. Found on top of No. 11.</p> <p>10. Jug of Coarse Ware, as No. 2. Height 11.4. Floor.</p> <p>11. Plain White jug, as No. 4. Reddish surface; rim chipped. Height 20.7. Found on top of No. 10.</p> <p>12. Plain White jug, as No. 9. Height 12.3. Floor.</p> <p>13. Plain White jug, as No. 4, but with collar-rim. Height 20.0. Found on top of No. 14.</p> <p>14. Plain White jug, as No. 4. Height 16.4. Found on top of No. 15.</p> <p>15. Plain White jug, as No. 13, but with cylindrical neck, and a ridge below neck. Height 20.7. Floor.</p> <p>16. Plain White jug, as No. 1, but with base-ring, and splaying rim. Height 12.1. Floor.</p> <p>17. Trefoil-shaped, open lamp of terracotta with plain base, and horizontal rim. Diam. 10.4. Floor.</p> <p>18. Plain White jug, as No. 5. Reddish surface. Height 10.0. Floor.</p> <p>19. Bronze coin; much corroded; illegible. Diam. 1.9. Weight 6.80. Floor.</p> <p>Bronze coin; much corroded; illegible. Diam. 1.7. Weight 5.74. Floor.</p> |
|--|--|

The Object Register can be summed up in the following diagram: —

P o t t e r y					Bronze	Terracotta
Pl. Wh.		Wh. P.	Coarse Ware	Coins	Lamp	
1, 3, 4, 5, 6, 7, 9	8	2, 10	19, 19	17		
11, 12, 13, 14, 15, 16, 18	-1	-2	-2	-1		
-14						



Fig. 177. Kountoura Trachonia. Tomb 7.
Interior view.



Fig. 178. Kountoura Trachonia. Tomb 8.
Interior view.

TOMB 8 (Figs 175; 178; 179: 4—7)

SIZE

	Length	Width	Depth	Height
Dromos	2.58	2.00	1.12	—
Stomion	0.21	0.91	—	0.95
Chamber	2.02	2.37	—	1.24

SHAPE

The dromos is short, and widens very much towards the entrance. It has only two low steps at the further end, but the lack of depth is counterbalanced by three steps in the stomion. The doorway is high, and had originally a rectangular outline. It was slightly de-faced by the erosion of the rock. The door stone is a roughly rectangular block with convex upper edge. The sides were wedged with narrow chips of rock stone. The chamber is square in shape, and of the same construction as Tomb 7 with a central basin surrounded by three wide ledges. The roof is a flat barrel-vault.

STRATIFICATION

In the dromos the filling consisted of three intact layers of broken *chavara*, and the chamber contained, except for the culture earth, thick masses of debris from the roof, and some earth from the dromos, which had poured in through the door-packing. On the ledge near the right side, lay a burial stratum representing one burial; near the back ledge was another which, however, was partly removed, or rather covered by the tomb-gifts of a third body. The latter had probably been situated on the left ledge, but was found swept down into the central basin. There the remains lay at the back part. By removing the tomb-gifts

to the back ledge and the mouldered remains to the basin, a place was cleared for a new burial on the left ledge. For some reason, however, this burial was never made. To divide the finds into chronologically different groups is a difficult matter, as all were found on the floors of the ledges.

BURIALS

The skeletons were not well enough preserved to allow of any conclusions being drawn as regards the burial customs.

FINDS (GROUPS: PL. LXXIV, 2, 3; L. OF PL. II)

1. Plain White biconical jug with flat base; short, narrow, concave neck; splaying rim, and handle from neck to shoulder. Height 10.3. Found on top of No. 2.
2. Plain White pear-shaped jug with flat base; narrow neck; collar-rim, and handle from neck to shoulder. Height 8.2. Floor.
3. Plain White depressed jug with base-ring; narrow, cylindrical neck; stilted rim, and handle from neck to shoulder. Height 16.3. Floor.
4. Plain White sack-shaped jug with flat base; convex rim, and handle from rim to shoulder. Traces of black paint on handle. Height 22.4. Floor.
5. Plain White jug, as No. 4. Rim chipped. Height 16.0. Floor.
6. Mine-shaped jar of Coarse Ware with sack-shaped, pointed body; convex shoulders; stilted rim, and two vertical handles below shoulder. Height 52.1. Floor.
7. Plain White jug, as No. 3, but with twin-handle. Floor.
8. Depressed, oval jug of Coarse Ware with flat base; bulging neck, and handle from rim to shoulder. Height 14.1. Floor.
9. Plain White jug, as No. 3, but with pinched mouth, and handle from rim to shoulder. Height 21.7. Floor.
10. White Painted oval jug with base-ring; tapering neck, and handle from neck to shoulder. Neck and handle covered with a thin, black slip. Rim missing. Height 16.5. Floor.
11. Jug of Coarse Ware, as No. 8. Height 14.4. Floor.
12. Jug of Coarse Ware, as No. 8. Height 12.2. Floor.
13. Plain White pear-shaped jug with flat base, and profiled rim. Height 5.5. Floor.
14. Jug of Coarse Ware, as No. 8. Height 12.6. Floor.
15. Jug of Coarse Ware, as No. 8. Height 15.5. Floor.
16. Plain White pear-shaped amphoriskos with flat base, and flat rim; two knob-shaped projections on shoulder. Height 6.9. Floor.
17. Plain White jug, as No. 3, but with collar-rim. Height 19.0. Floor.
18. Plain White oval jug with base-ring; distinct shoulder; cylindrical neck; stilted rim, and an arched twin-handle from neck to shoulder. Height 20.5. Floor.
19. Plain White jug, as No. 9. Height 13.9. Floor.
20. White Painted depressed jug with distinct shoulder; flat base; concave neck; pinched mouth, and handle from rim to shoulder. Encircling lines around rim, neck, and body, vertical, leaf-shaped stripes on shoulder, and transverse lines on handle. Height 9.3. Floor.
21. Plain White torpedo-shaped, cylindrical jug with pointed base; conical shoulder; concave neck; splaying rim, and vertical handle below shoulder. Height 31.5. Floor.
22. Horseshoe-shaped finger-ring of bronze with a large oval bezel. On the bezel is engraved a representation of a sphinx with unfolded wings, and tail curved upwards sitting in left profile on top of an Ionic capital. In front of the sphinx is a hieroglyphic sign. Diam. 2.4. Floor.

A summary of the Object Register gives the following diagram:—

P o t t e r y											Bronze	
Pl. Wh.							Wh. P.	Coarse Ware			Ring	
1.	2.	3.	4.	5.	7.	9.	10.	20.	6.	8.	11.	22
13.	16.	17.	18.	19.	21.			12.	14.	15.		
			-13.				-2.		-6.		-1.	

TOMB 9 (Figs. 179: 8—9; 180)

SIZE

Length	Width	Depth
2.15	0.84	1.24

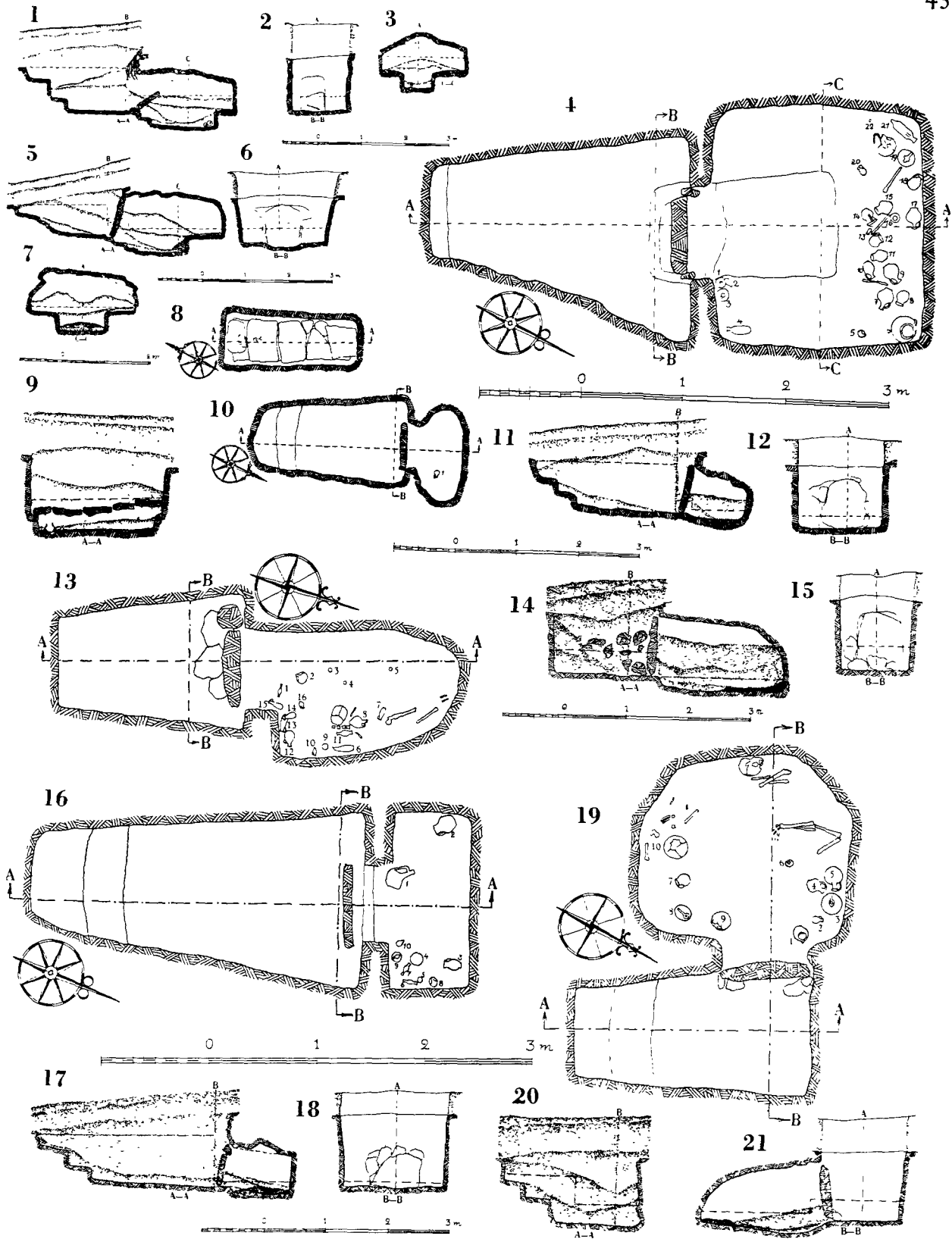

Fig. 179. Kountoura Trachonia. Tomb 7, Sections A-A, B-B, C-C (1, 2, 3). Tomb 8, Plan (4); Sections A-A, B-B, C-C (5, 6, 7). Tomb 9, Plan (8); Section A-A (9). Tomb 11, Plan (10); Sections A-A, B-B (11, 12). Tomb 12, Plan (13); Sections A-A, B-B (14, 15). Tomb 14, Plan (16); Sections A-A, B-B (17, 18). Tomb 13, Plan (19); Sections A-A, B-B (20, 21).

SHAPE AND STRATIFICATION

The tomb is a narrow, rectangular, rock-cut shaft with perpendicular sides. The lower section of the shaft is of slightly smaller dimensions than the upper, and a ledge is thus formed in the rock on which rested five large, covering slabs. Below the slabs lay the scanty remains of a body, and two vases.

The whole shaft was filled with *chavara* dust, and the tomb was evidently intact.

FINDS

- | | |
|--|---|
| 1. Depressed crater of Coarse Ware with round base; splaying rim, and two handles from rim to shoulder. One handle, and several pieces of body missing. Height c. 16.0. Floor. | 2. White Painted oval jug with narrow base; cylindrical neck, and stilted rim. Encircling lines around shoulder. Surface much worn. Brown, lustrous paint directly on the rough ground. Height 13.2. Floor. |
|--|---|

TOMB 10

SIZE

	Length	Width	Depth	Height
Dromos	2.83	1.60	1.34	—
Stomion	0.25	0.70	—	c. 0.75
Chamber	3.01	2.38	—	c. 0.95

SHAPE

The dromos is of the normal, stepped type, and very careful workmanship. The stomion is destroyed through a partial collapse of the rock, but its height could be reconstructed by means of two jambs of poros stone which gave the dimensions of the door. Thanks to these jambs the door stone remained *in situ*, when the stomion was destroyed. The plan of the chamber is rectangular, and its interior closely resembles that of Tomb 8. The centre of the chamber is occupied by a rectangular basin of approximately the same width as the doorway, and starting just at the end of the stomion. Broad ledges surround the basin on the three other sides. The roof was rather damaged, but could be reconstructed as a low barrel-vault. Floor and ledges are horizontal.

STRATIFICATION

In the dromos was an oblique bottom layer of hard, rammed *chavara* starting from the middle step and confined by the back section of the dromos. This was, apparently, the remainder of the original dromos-filling. On top of this, lay two layers of coarse rock material containing many stones and chips of rock. They were the result of a refilling of the partly excavated dromos, and the stratification, thus, indicates repeated burials in the chamber. The top layer above the fallen-in stomion was of a dark colour, and has evidently attracted the moisture from the rain-water. On the ledges in the chamber lay thin burial strata covered by debris from roof and stomion. All the finds were laid directly on the floor of

the ledges, and in the central basin. The stratification, therefore, does not aid in fixing the relative chronology of the contents: other indications are also very poor, and it seems safer to treat the tomb-gifts as one group.

BURIALS

The skeletal material was so fragmentary that nothing can be said with certainty about the original positions of the bodies. Only the ledges have been used as burial places, and the central basin was occupied by common deposits of tomb-gifts. Among the burial gifts was an extraordinary number of coins.

FINDS (GROUPS: PL. LXXV; TYPES: L. OF PL. II)

1. Black Lustrous shallow bowl with base-ring, and in-bent rim. Thick ware. Diam. 12.0. Found on top of No. 2.
2. Plain White oval jug with base-ring; wide, cylindrical neck; splaying, profiled rim, and handle from rim to shoulder. Height 23.2. Floor.
3. Black Lustrous pear-shaped jug with high base-ring; short, concave neck; flaring rim, and handle from neck to shoulder. Handle missing. Paint worn. Height 14.9. Floor.
4. Black Lustrous sack-shaped jug with flat base; splaying rim, and handle from rim to shoulder. Paint worn, mottled surface. Height 14.1. Floor.
5. Plain White oval jug with flat base; narrow, concave neck; stilted rim, and handle from rim to shoulder. Handle missing. Height 9.3. Floor.
6. Black Lustrous jug, as No. 3. Height 12.0. Floor.
7. Plain White depressed jug with base-ring. Neck and handle missing. Floor.
8. White Painted sack-shaped jug with flat base; narrow, short neck, pinched mouth, and handle from rim to shoulder. Vertical stripes from rim to base. Height 9.6. Floor.
9. Black Lustrous jug, as No. 4. Rim and handle missing; mottled surface. Height 17.7. Floor.
10. Black Lustrous bowl, as No. 1. Diam. 13.1. Floor.
11. Bronze coin; corroded; illegible. Diam. 1.6. Weight 4.65. Floor.
Bronze coin; corroded; illegible. Diam. 1.5. Weight 3.75. Floor.
Bronze coin; corroded; illegible. Diam. 1.2. Weight 2.05. Floor.
Bronze coin. *Obverse*: Head of Alexander the Great in right profile. *Reverse*: Quiver and club. Diametrically: *ΔΕΜΗΤΡΙΟΥ* Border of dots. (Demetrius Poliorcetes.) Diam. 1.7. Weight 6.15. Floor.
Bronze coin, as above, but worn. Diam. 1.7. Weight 5.50. Floor.
12. Bronze coin. *Obverse*: Bearded head of Zeus in right profile. Border of dots. *Reverse*: Eagle on thunderbolt; wings open; head in left profile. Upwards from left: *ΠΤΟΛΕΜΑΙΟΥ ΒΑΣΙΛΕΥΣ*. Diam. 2.00. Weight 6.95. Floor.
Bronze coin, as above, but much worn. Diam. 2.0. Weight 6.90. Floor.
Bronze coin, as above. Diam. 1.6. Weight 3.35. Floor.
13. Plain White jug, as No. 7, but with concave neck, and arched handle from rim to shoulder. Rim missing. Height 15.7. Floor.
14. Plain White sack-shaped jug with flat base; splaying rim, and handle from rim to body. Height 16.9. Floor.
15. Black Lustrous jug, as No. 4. Rim and handle missing; mottled surface, paint worn. Height 17.4. Floor.
16. Black Lustrous jug, as No. 4. Rim and handle missing; mottled surface; paint worn. Height 17.7. Floor.
17. Black Lustrous jug, as No. 4. Rim and handle missing; mottled surface; paint worn. Height 15.7. Floor.
18. Black Lustrous jug, as No. 3. Handle missing; mottled surface. Height 11.0. Floor.
19. Black Lustrous bowl, as No. 1. Diam. 7.4. Floor.
20. Black Lustrous jug, as No. 3. Height 12.2. Floor.
21. Wide, squat cooking-pot of Coarse Ware with round base; splaying rim, and handle from rim to shoulder. Handle missing; rim chipped. Height 13.3. Floor.
22. Black Lustrous jug, as No. 3. Handle missing. Height 12.4. Floor.
23. Bronze coin; corroded, illegible. Diam. 2.0. Weight 4.65. Floor.
Bronze coin; corroded; illegible. Diam. 1.8. Weight 3.45. Floor.
Bronze coin; corroded, illegible. Diam. 1.7. Weight 3.70. Floor.
Bronze coin; corroded; illegible. Diam. 1.6. Weight 2.55. Floor.
Bronze coin. *Obverse*: Bearded head of Zeus in left profile; probably wearing taenia. Border of dots. *Reverse*: Eagle on thunderbolt; wings open. Left of eagle an oval shield; above the shield a monogram. Upwards from left: *ΠΤΟΛΕΜΑΙΟΥ ΒΑΣΙΛΕΥΣ* (Ptolemaeus II) Diam. 2.8. Weight 14.60. Floor.
Bronze coin, as above, but much worn. Diam. 1.8. Weight 4.00. Floor.

- 24. Plain White wide, conical amphora with pointed base, and small base-knob; cylindrical neck; thick rim, and two handles from neck to shoulder. Height 62.0. Floor.
 - 25. Plain White jug, as No. 7, but with short, concave neck; pinched mouth, and handle from rim to shoulder. Height 17.7. Floor.
 - 26. Black Lustrous jug, as No. 4. Mottled surface; deformed in the kiln. Height 17.3. Floor.
 - 27. Plain White jug, as No. 5. Stroke polished surface. Height 11.3. Floor.
 - 28. Black Lustrous bowl, as No. 1. Diam. 11.4. Floor.
 - 29. Black Lustrous jug, as No. 4. Mottled surface. Height 16.5. Floor.
 - 30. Black Lustrous depressed jug with base-ring; wide, cylindrical neck; large, profiled rim, and handle from neck to shoulder. Height 11.4. Floor.
 - 31. Red Slip pear-shaped jug with round base; short, concave neck, and large, flaring rim. Height 8.5. Floor.
 - 32. Plain White jug, as No. 25, but with collar-rim. Handle missing. Height 18.1. Floor.
 - 33. Black Lustrous jug, as No. 30, but with narrow neck. Height 13.5. Floor.
 - 34. Black Lustrous jug, as No. 3. Height 12.6. Floor.
 - 35. Black Lustrous squat jug with base-ring; horizontal shoulder; concave, wide neck; splaying rim, and an arched handle from rim to shoulder. Height 8.6. Floor.
 - 36. Black Lustrous very squat, biconical jug with wide base-ring, and convex shoulder. Handle and neck missing. Height 5.0. Floor.
 - 37. Bronze coin; corroded, illegible. Diam. 1.8. Weight 4.75. Floor.
- Bronze coin; corroded; illegible. Diam. 1.2. Weight 2.25. Floor.
- Bronze coin. *Obverse*: Bearded head of Zeus in left profile. Border of dots. *Reverse*: Obliterated. (Ptolemaeus II.) Diam. 2.7. Weight 13.8. Floor.
- Bronze coin. *Obverse*: Bearded head of Zeus in left profile. Border of dots. *Reverse*: Eagle on thunderbolt; wings open. Oval shield to the left of eagle, and above shield a monogram. Border of dots. Upwards from left: *ΙΤΟΛΕΜΗΙΟΥ ΒΑΣΙΛΕΥΣ*. Worn. (Ptolemaeus II.) Diam. 2.8. Weight 13.65. Floor.
- Bronze coin. *Obverse*: Obliterated. *Reverse*: Fore part of humped bull. In the field to the left a monogram. (Seleucus II.) Diam. 1.3. Weight 2.05. Floor.

Summing up the Object Register, we obtain the following diagram: —

P o t t e r y						B r o n z e							
Pl. Wh.			Bl. Lustrous			R. Sl.	Wh. P.	Coarse Ware		Coins			
2.	5.	7	1.	3.	4.	31	8	21	11.	11.	11.	11.	11
13.	14	24	10.	15.	16.				12.	12.	12.	23.	23
25.	27	32	19.	20.	22.				23.	23.	23.	23.	37
			29.	30.	33.				37.	37.	37.	37.	37
			36										
-9			-21			-1	-1	-1	-19				

TOMB 11 (Fig. 179: 10—12)

SIZE

	Length	Width	Depth	Height
Dromos	2.60	1.34	0.98	—
Stomion	0.21	0.65	—	0.71
Chamber	0.68	1.48	—	0.75

SHAPE

The dromos is somewhat shallower than usual, but of essentially the same type as those above-described. The chamber is entered by a slightly sloping stomion, blocked by a large slab of local limestone. It is an elongated oval in shape with the entrance from the long side, and its dimensions are very small.

STRATIFICATION

The dromos was filled with horizontally stratified *chavara* material in two layers. Just in front of the door is a narrow, perpendicular stratum, caused by the surface water that has found its way down into the chamber. In the chamber lay some fragments of a child's skeleton together with a vase. It was covered by debris from the roof, and a fan-shaped layer of dromos earth which had intruded through the door-packing.

FIND (GROUP: PL. LXXIV, 4)

1. Plain White squat jug with base-ring; narrow, concave neck; splaying, pinched mouth, and an arched handle from rim to shoulder. Two ridges between neck and shoulder, and a sharp edge on top of handle. Height 11.4. Floor.

TOMB 12 (Fig. 179: 13—15)

SIZE

	Length	Width	Depth	Height
Dromos	1.72	1.24	1.21	—
Stomion	0.30	0.73	—	0.94
Chamber	1.66	1.16	—	1.08

SHAPE

The dromos is a parallelepipedic pit with vertical sides and horizontal floor. No steps are cut in the back wall. The stomion is a short passage, blocked by a flat, upright slab, kept in position by several uncut stones. The chamber is asymmetrical, and the stomion opens close to the left side wall; the back wall of the chamber is curved. Only to the right of the entrance is a rectangular corner.

STRATIFICATION

At the further end of the dromos lay two short, horizontal strata of *chavara* which were cut through by an oblique layer of loose consistency, containing many stones of various sizes. This must be interpreted as an indication of repeated burials in the chamber, the horizontal strata being the remains of an original dromos-filling. Near the back wall of the chamber, lay a removed burial stratum representing the earlier stage, and along the right side the later burial was found. The finds were mainly found in a common deposit close to the door, and cannot, therefore, be conveniently distributed between the two groups. Burials and finds lay directly on the floor, and were covered by heavy masses of debris from roof, walls, and stomion.

BURIALS

The later body was only partly preserved. The skull, the back bone, a femur, and a tibia indicate that the body was buried according to the usual method, i. e., in dorsal, outstretched position with the head towards the door.

FINDS (GROUPS: PL. LXXIV, 5, 7; TYPES: L. OF PL. II)

1. Black Lustrous slender tear-bottle with high base; widening neck, and stilted rim. Height 12.7. Floor.
2. Trefoil-shaped, open lamp of terracotta with flattened base, and horizontal rim. Diam. 12.1. Floor.
3. Bronze coin; much corroded; illegible. Diam. 2.0. Weight 7.05. Floor.
4. Bronze coin. *Obverse*: Head of horned Zeus Ammon in right profile. *Reverse*: Cult statue of Aphrodite, standing fullface on a low pedestal; she wears long chiton, draped in archaic manner; right hand rests upon her breast, while in her lowered left she holds a flower. Border of dots. Upwards from left: *HTO.IEM HTOI B.IΣI.IEΩΣ*. (Ptolemaeus III.) Diam. 2.5. Weight 12.75. Floor.
5. Bronze coin; much corroded; illegible. Diam. 1.5. Weight 3.50. Floor.
6. Black Lustrous sack-shaped jug with flat base; splaying rim, and handle from rim to shoulder. Rim chipped; handle missing. Height 20.7. Floor.
7. Black Lustrous jug, as No. 6. Paint worn. Height 12.4. Floor.
8. Black Lustrous oval jug with base-ring; very narrow, concave neck; thick, flaring rim, and handle from rim to shoulder. Base not painted. Height 16.3. Floor.
9. Black Lustrous jug, as No. 6; upper part of jug missing. Mottled surface. Height 7.5. Floor.
10. Plain White oblong jug with flat base; narrow, cylindrical neck; stilted rim, and handle from neck to shoulder. Height 7.7. Floor.
11. Plain White wide tear-bottle with tall base; widening neck, and stilted rim. Height 15.5. Floor.
12. Black Lustrous pear-shaped jug with base-ring; flaring rim, and vertical handle on shoulder. Mottled surface. Height 14.7. Floor.
13. Black Lustrous jug, as No. 6. Paint worn. Height 15.2. Floor.
14. Black Lustrous jug, as No. 6. Height 16.4. Floor.
15. Black Lustrous jug, as No. 6. Height 15.3. Floor.
16. Plain White jug, as No. 10. Height 8.5. Floor.

The Object Register is summed up in the diagram below: —

P o t t e r y		Bronze	Terracotta
Pl. Wh.	Bl. Lustrous	Coins	Lamp
10. 11. 16	1. 6 7 8. 9, 12 13. 14. 15	3 4. 5	2
-3	-9	-3	-1

TOMB 13 (Fig. 179: 19—21)

SIZE

	Length	Width	Depth	Height
Dromos	2.18	1.33	1.11	—
Stomion	0.22	0.79	—	0.94
Chamber	1.74	1.92	—	1.05

SHAPE

The dromos is of the same type as most of the above-described tombs, i. e., a short passage with three regular steps at the further end, and a rectangular, horizontal area in front of the stomion. The stomion, however, does not open, as usual, into the prolongation of the longitudinal axis of the dromos, but is cut at the end of the left-hand side. It is short and wide, and slopes gently down to the level of the chamber floor. The door-packing consisted of an upright slab of limestone, wedged and supported by several small stones. The plan of the chamber is an irregular square with rounded corners. The floor is horizontal and roof and walls form a flat vault.



Fig. 180. Kountoura Trachonia.
Tomb 9.

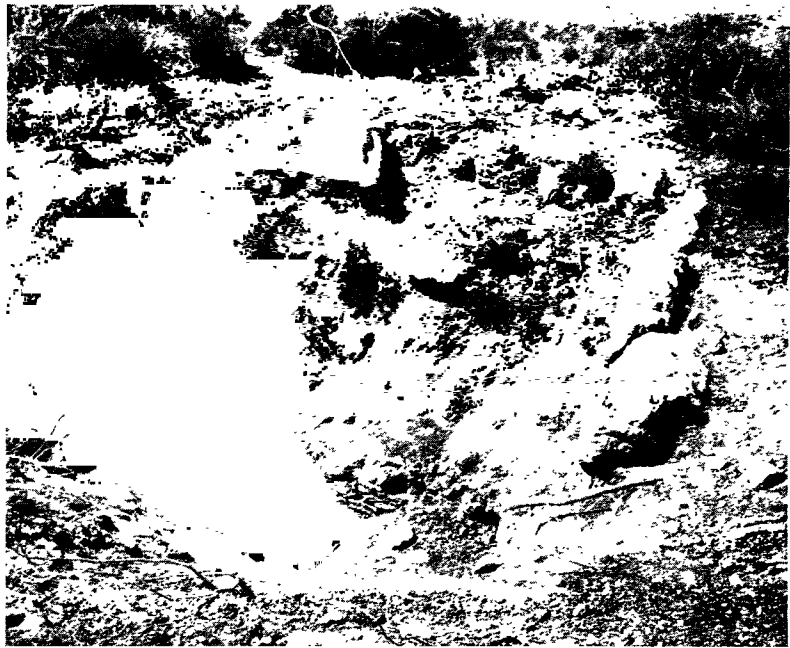

Fig. 181. Kountoura Trachonia. The tumulus of Tomb 15.

STRATIFICATION

The dromos was filled by three layers of rock material. They were all intact, but formed down-curving lines in the longitudinal axis of the dromos, owing to the position of the stonion. The culture earth in the chamber lay directly on the floor and consisted of scanty remains of two burials, one near each long side of the chamber. All the tomb-gifts were found on the floor, and the find stratum was covered by a thin layer of debris from the roof and some earth which had found its way into the chamber through the stones of the door-packing.

BURIALS

The state of preservation of the skeletal material did not permit any conclusions to be drawn as regards the original positions of the bodies.

FINDS

1. Oval jug of Coarse Ware with flat base; wide, convex neck, and handle from rim to shoulder. Height 12.7. Floor.
2. Plain White oval jug with flat base; convex neck; collar-rim, and handle from neck to shoulder. Height 9.9. Floor.
3. Plain White biconical jug with base-ring, narrow, concave neck; pinched mouth, and twin-handle from rim to shoulder. Reddish surface. Height 21.7. Floor.
4. Plain White jug, as No. 3, but of depressed, globular shape, and with a plain handle from rim to shoulder. Height 18.4. Floor.
5. Plain White jug, as No. 4. Height 24.5. Floor.
6. White Painted very squat, biconical jug with base-ring; convex neck; pinched mouth, and handle from rim to shoulder. Vertical stripes on shoulder. Handle missing. Height 8.8. Floor.
7. Jug of Coarse Ware, as No. 1. Height 12.5. Floor.
8. Plain White large askos with base-ring, collar-rim, and a profiled, knobbed handle from neck to body. Height 17.0. Floor.
9. Plain White jug, as No. 3, but with convex neck, and a plain handle from rim to shoulder. Height 17.0. Floor.
10. Plain White jug, as No. 4. Height 26.0. Floor.

The Object Register is summed up in the diagram here below:—

P o t t e r y		
Pl. Wh.	Wh. P.	Coarse Ware
2, 3, 4, 5, 8, 9, 10	6	1, 7
-7	-1	-2

TOMB 14 (Fig. 169: 16—18)

	SIZE			
	Length	Width	Depth	Height
Dromos	3.04	1.62	1.18	—
Stomion	0.25	0.70	—	0.63
Chamber	0.73	1.62	—	c. 0.70

SHAPE AND STRATIFICATION AND BURIALS

The proportions between chamber and dromos are not of the normal type. The dromos is very long, wide and shallow, and the chamber is of a small, rectangular plan. The stomion was blocked up by a short slab, wedged with many small stones. The dromos-filling consisted of *chavara* material in two layers, and the chamber contained, except for a burial stratum on the floor, a small amount of extraneous earth. The few fragments of bone that were found belonged, apparently, to one body which had been placed in a dorsal, out-stretched position with the head to the East. To judge from the shortness of the burial stratum the remains do not seem to have belonged to a grown up person. They were surrounded by some vases as tomb-gifts.

FINDS (GROUP: PL. LXXIV, 6; TYPES: L. OF PL. II)

1. Plain White squat, biconical jug with base-ring; tall, tapering neck, and a long, angular handle from neck to shoulder. Height 27.3. Floor.
2. Oval jug of Coarse Ware with flat base; widening neck; in-bent rim, and handle from rim to shoulder. Height 20.5. Floor.
3. Black Lustrous oval jug with base-ring; widening neck; stilted rim, and handle from neck to shoulder. Mottled surface. Height 15.5. Floor.
4. Plain White rounded bowl with small base-ring. Diam. 11.8. Floor.
5. Plain White small, biconical jug with flat base; narrow, concave neck; thick, stilted rim, and handle from rim to shoulder. Height 5.6. Floor.
6. Plain White slender tear-bottle with high base; cylindrical neck, and stilted rim. Height 13.8. Floor.
7. Plain White tear-bottle, as No. 6. Height 13.3. Floor.
8. Trefoil-shaped, open lamp of terracotta with flattened base, and horizontal rim. Diam. 9.4. Floor.
9. White Painted pear-shaped jug with flat base; cylindrical neck; pinched mouth, and handle from rim to shoulder. An encircling line around neck, and vertical stripes from neck to base. Height 12.4. Floor.
10. Black Lustrous covered, squat lamp with raised, flat base; tubular nozzle, and two projections. A rough relief of a winged head, and radiating stripes on upper side. Diam. 9.4. Floor.

Summing up the Object Register, we obtain the following diagram: —

P o t t e r y				Terracotta	
Pl. Wh.	Wh. P.	Bl. Lustrous	Coarse Ware	Lamps	
1, 4, 5, 6, 7	9	3	2	8, 10	
-5	-1	-1	-1	-2	

TOMB 15 (Figs. 181; 182: 1—2)

SIZE

	Length	Width	Depth	Height
Tumulus	c. 7.50	c. 6.35	—	c. 1.70
Dromos	2.56	1.44	1.10	—
Stomion	0.22	0.65	—	0.60
Chamber	0.88	1.11	—	0.72

SHAPE AND STRATIFICATION OF THE TUMULUS

The tumulus is a low, nearly circular heap of earth placed right over a rock-cut tomb. It consists of conical layers of earth; clay with small stones; rocky matter, and gravel. In order to strengthen the construction some stones were laid on the rock behind the further end of the dromos. Against this the lower strata of the tumulus were piled up. The top of the mound is marked by a rectangular casing of large, upright slabs of local limestone. The upper edges of the slabs lay on a level with the surface of the tumulus, projecting slightly above the ground. The top of the tumulus was dug through in modern times and the stone casing was partly removed. The tomb-robbers had, with their narrow shaft, come exactly upon the stomion of the tomb below. The door stone was found over-turned, and the chamber completely sacked. The excavation was carried through in order to get a complete plan of the tomb, and in the hopes of finding datable sherds.

SHAPE AND STRATIFICATION OF THE TOMB

The dromos very much resembles the type we are used finding in this necropolis. It is a long, shallow, and fairly wide passage, provided with two steps at the further end. A large horizontal area is cut in front of the stomion, a slightly sloping, narrow tunnel of no great length. The chamber is irregular and of small size. It contained only some sherds of the usual Plain White Ware.

CHRONOLOGY

The tombs of Kountoura Trachonia can only be dated by means of the coins found in them. Of the fifteen tombs only four contain coins. They are Tombs 2, 7, 10, and 12.

Tomb 2 contains four coins, three of which are illegible and the fifth datable to Ptolemaeus II. In Tomb 7 were found two coins both illegible. Tomb 10 is the best of the tombs as regards coins. There are nineteen of them, two of which belong to Demetrius Poliorcetes, five to Ptolemaeus II and one to Seleucus II. Two other badly worn pieces can with approximate certainty also be attributed to Ptolemaeus II. The rest are illegible. Finally Tomb 12 contains two illegible, and one belonging to Ptolemaeus II.

For making these notices more surveyable they are arranged in a table: —

	Tomb 2	Tomb 10	Tomb 12
Demetrius Poliorcetes		2	
Ptolemaeus II	1	5 (7)	
Ptolemaeus III			1
Seleucus II		1	

The coin of Demetrius Poliorcetes according to Hill¹ was struck 294 B. C. after the capture of Salamis, and most of the coins of Ptolemaeus II are of the type struck in Cyprus about 270—260 B. C. That of Ptolemaeus III dates from the middle of the third century.¹ Finally, Seleucus II Callinicus reigned 246—226 B. C. The coins thus span almost over the whole third century B. C., and its later half is the date to which the tombs ought to be ascribed. Both the earliest and the latest coin are found in Tomb 10. Although repeated burials had taken place in the tomb, the archaeological evidence seems to show that the difference in time between the first and the last burials was rather short. This is a warning from using the coins as exact chronological data. In spite of the presence of a coin struck 294 B. C. the *terminus post quem* for the tomb must be 246, the date of Seleucus II's accession to the throne.

E. S.

T R A C H O N I A S

INTRODUCTION

After some three miles' walk along the shore eastwards from Kountoura Trachonia, one comes upon a locality called Trachonas. It is situated some two miles S. E. of Gallinoporni, and the fields of the village with plantations of carob-trees extend right down to the sea. The site is an ancient burial ground containing tombs from the Cypro-Geometric II period down to Hellenistic times. Most of them are rifled. One tomb was said to have been enormously rich. It was a vaulted structure, built of huge slabs which had to be broken in forcing the entrance. The monument was still to be seen, as the blocks were too large to be removed and used for modern building purpose. The Expedition decided to inspect the place, and ten days were spent at the end of April, 1928, in clearing the tomb and its vicinity. The result of the investigation is presented here below.

THE BUILT TOMB (Figs. 182: 3—9; 183—186)

SIZE

	Length	Width	Depth	Height	Diam.
Tumulus	—	—	—	—	c. 23.0
Dromos	6.65	2.56	3.60	—	—
Stomion	0.55	0.90	—	0.93	—
Chamber	3.27	2.72	—	2.35	—

SHAPE AND STRATIFICATION

The tomb is situated on a hill-slope, and is a tumulus tomb, although the present state of preservation of the mound is very bad. Its construction can be described in the main as follows. The mound was erected above a large, roughly rectangular pit cut in the rock. On the bottom of the pit, which measured about 16 m. 11 m. square and about 6 m. in depth, the tomb chamber was built on top of some substructions. Through the debris of the mound a wide, stepped dromos leads down to the entrance of the chamber. The S. W. edge of the square pit is on a level with the ground, so that no sharp edge is to be found at this

TRACHONAS

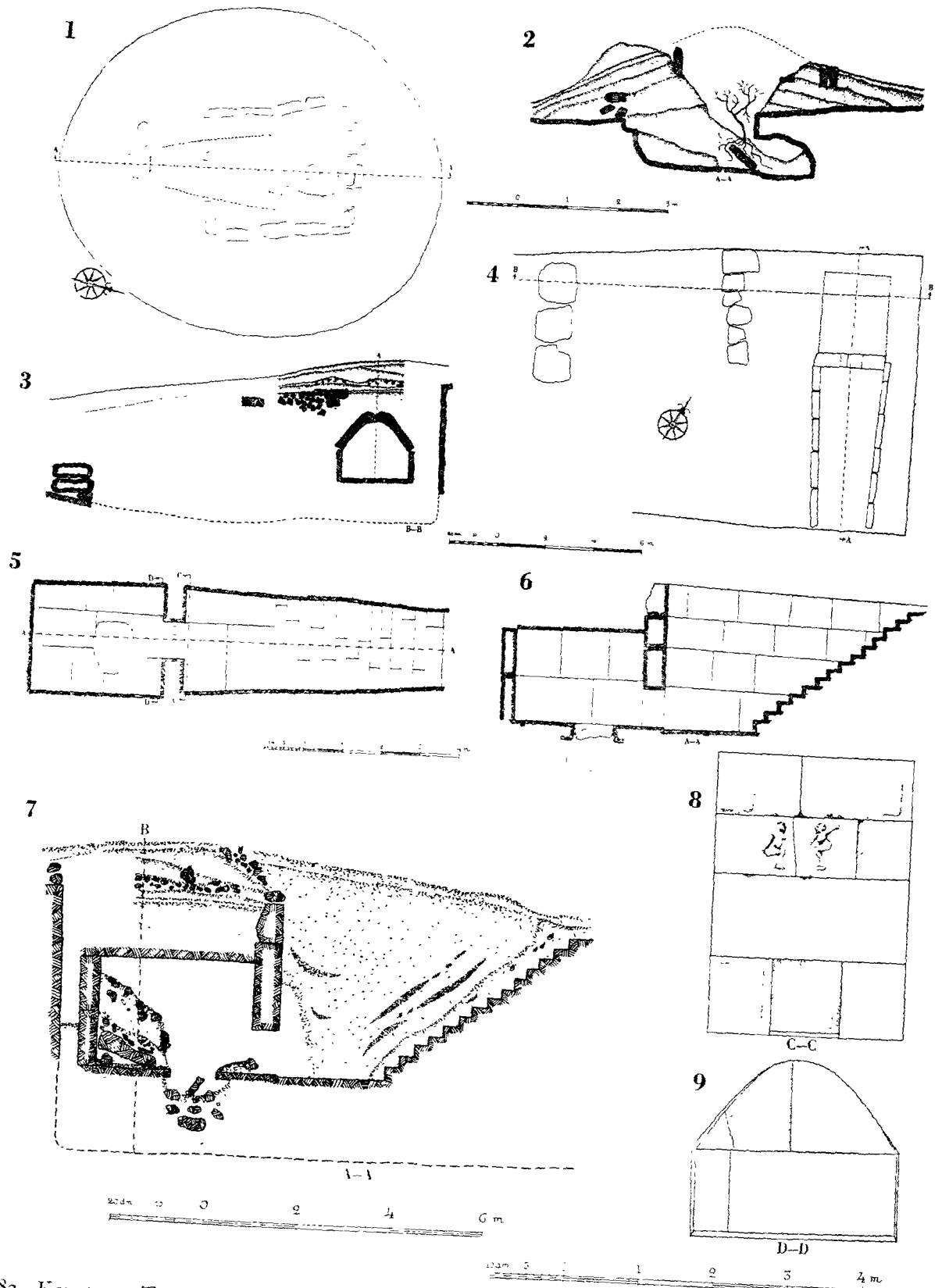

Fig. 182. Kountoura Trachonia. Tomb 15, Plan (1); Section A-A (2). Trachonias. The built tomb, Section B-B (3); Plan (4); Architectural plan (5) and section (6); Sections A-A, C-C, D-D (7, 8, 9).



Fig. 183. Trachonas. The dromos.



Fig. 184. Trachonas. The dromos seen from the doorway.

part. All the blocks and rock debris that were the products of the enormous cuttings were taken out this way. The preparations for the construction of the tomb were carried out in the same way as when stone cutters work in an ordinary Cypriote quarry. As a matter of fact, it seems very probable that the stones used for building the tomb were extracted from the pit. They consist of the same sandstone as the local rock.

On heavy substructions of roughly cut stones was found the tomb-chamber, entirely covered by the mound. On the S. W. side where no rock-cut edge supported the structure, a low, massive wall of roughly dressed masonry sustained the impending masses of the mound. In order not to weaken the structure, the tumulus was not trenched through entirely, and so its stratification and construction could be only partly studied. The mound consisted of several layers of clayey earth, stones, and rock debris alternating more or less regularly with each other.

The dromos of the tomb widens slightly towards the entrance of the chamber, and consists of fourteen regular steps of an average height of 0.25 m. and a length of about 0.30 m. Each step is built of two slabs, well fitted together and forming a perfectly horizontal plane. This staircase leads down to a square area in front of the door. The floor of this area which is built of three large blocks, slopes slightly towards the last step of the staircase, thus preventing rain-water from accumulating in the chamber. The sides of the dromos are built of similar slabs, the largest one measuring 2.10 m. in length. Plaster is used as binding

material, but the joints are very close. Each wall consists of four parallel courses of blocks which slope in the same direction as the floor of the frontal area. The average height of the courses is 0.90 m. The thickness of the blocks is not more than 0.30 m. The short front wall of the dromos is built in the same way. In the lower part the blocks are of still larger dimensions. The lintel blocks, for instance, measure $3.55 \times 1.10 \times 0.65$ m. and reach from edge to edge of the dromos.

The wall above the door is decorated with two rather weathered sculptures in relief. The left one is a steatopygous male figure in right profile. Its total height is 0.58 m. The head is long and narrow with projecting nose and chin, short hair, and is probably close-shaved. The left arm is bent at the elbow and lifted in a gesture of adoration, the right one hangs straight behind the back, with the hand resting on the enormous hinder parts. The legs, only one of which is seen in the relief, are bent at the knees; the feet are large and the heels slightly lifted.

The right figure is of a similar type but somewhat smaller (total height 0.53 m). It faces the left one and is in left profile. The head is more depressed; the hair short and flying backwards, and the nose very projecting, almost beak-shaped. The right arm is directed forwards, the left one backwards, indicating a vivid movement. The legs and posteriors are of the same type as those of the left figure, but the foot is lifted, so that the right one can be seen only indistinctly behind it.

The action of these two strange figures must be interpreted as a ritual dance, and it seems probable that they are to be understood as death dæmons, not as human beings (see Vol. IV).

Flanking the figures are square, rustic excrescences on the top blocks.

The entrance of the chamber is a very small, square hole, which was formerly blocked by a single stone, fitting exactly to the opening. A narrow, cylindrical hole in the threshold, close to the right jamb, shows that the door has turned on a pivot. The chamber lies on the same level as the front area of the dromos. It is built in the same sort of well-dressed masonry as the dromos, and is covered by a false barrel-vault, constructed of six large blocks, three on each side. The blocks are curved and lean against the opposite row, meeting in the middle. Traces of red colour on the walls indicate that the chamber had been decorated with paintings of linear designs. The back wall was broken through from outside, whence the modern tomb-robbers had entered by smashing one of the blocks. They had also injured the floor by lifting one of the slabs and digging into the substructions of the mound. Further, they had broken the door of the tomb from the inside, and dug a hole in the filling of the dromos in their search for another chamber. Otherwise the structure had not suffered any damage.

The stratification of the dromos was very instructive. Close to the steps was a very thin intact layer of the original dromos-filling. This ended at the beginning of the square area in front of the door, and was to its entire extent covered by a secondary layer of filling of a much looser consistency, containing gravel, small stones, and earth mixed with decomposed rock. This was a proof of two separate burial periods.

The chamber had been searched by the tomb-robbers, and was partly filled with debris



Fig. 185. Trachonas. Interior view.



Fig. 186. Trachonas. The reliefs above the entrance.

dug up from the pit in the floor. Masses of foreign earth had also intruded through the hole in the back wall. In one of the back corners there was a thin layer of small extent which gave the impression of being almost intact. It consisted of the dark brown earth, usually found in the burial strata of tombs. The sherds obtained from this layer have been kept in a separate group.

CHRONOLOGY

As the tomb, for easily understood reasons, contained no finds, the dating must be based only on the type of structure, the reliefs, and the sherds from the supposed intact layer in the chamber.

The type of tomb must certainly be connected with the built tombs of Tamassos, excavated by Mr. Ohnefalsch-Richter. The dromoi and the main type of construction are, in both cases, the same. Thin sandstone blocks of considerable dimensions are used, and the masonry is essentially of the same construction. The chambers differ in many important details, but the roofs are built in accordance with the same principles, i. e., rows of huge blocks leaning against each other and forming a false vault. At Tamassos the interior is shaped like a saddle-roof, and sculptured like large beams in evident imitation of a wooden construction; here at Trachonas the insides of the blocks are curved in the shape of a barrel-vault. This fact does not necessarily indicate a difference in time, as is shown by the tombs at Marion, where the same necropolis contains contemporary chamber tombs of both these types (see Vol. II).

The tombs at Tamassos are reliably dated to Cypro-Archaic time, and the construction of our tomb points decidedly to the same era. The relief figures are certainly of a very primitive type which entirely agrees with this dating.

Finally, the sherds from the supposed intact layer can be dated to the same period.

There is one fragment of a spherical bottle with flat funnel-rim and handle-ridge. It is decorated with concentric circles round the shoulder, encircling lines around neck and rim, and small, black triangles on the rim. It can be classified as a fairly late specimen of the White Painted IV class. Four other fragments belong to a flat bowl of the Plain White IV class with flat, out-turned rim and no handle.

As all three data of chronology point to the same period, the tomb can be dated to the middle of the Cypro-Archaic I period.

But sherds from the upper dromos-filling and the fragments found in the removed layers of the chamber are of quite another type and date. They consist of Plain White pottery of late Hellenistic date. Jugs with pinched mouths, like those found at Kountoura Trachonia, and coarse domestic pottery prevail. In the dromos was found a lamp with biconical body, flat bottom, a long nozzle, and a hole at the top of the body, which latter is decorated with incised, radiating lines. This material gives the date of the second burial, the tomb-gifts of which the modern plunderers had taken. Their description of chandeliers, golden bracelets, ring-stones and bronze vessels is in entire agreement with the date.

E. S.

E N K O M I

The Necropolis

INTRODUCTION

The necropolis of Enkomi was found and extensively investigated in 1896 by Messrs. Murray, Smith, and Christian on behalf of the Cyprus Exploration Fund. The extraordinarily rich contents of the tombs, including Mycenæan pottery, jewelry, ivories and faience, gave encouragement for further explorations. For more than 30 years the old necropolis has been the object of clandestine excavations, and hundreds of tombs have thus been plundered. The Cyprus Museum made a trial excavation in 1913, without, however, finding any tombs, and equally negative was the result of a small experimental search by Mr. R. Gunnis in 1927.

A topographical description of the place is found in Mr. Murray's publication.¹ In connection with this, the following notes may be added (Plan II, 3).

East of the village of Enkomi, there extends for half a mile a flat plateau, where the white limestone rock is covered only by a very thin layer of sandy earth. It is poorly cultivated, and mainly used as pasture. The plateau ends in a steep crag, and below this lies the necropolis at a locality called Ajios Jakovos. The ground, which consists of the same sedimentary rock as the plateau, slopes gradually down to a small river-bed, and is covered with heavy masses of architectural debris and culture earth, sometimes reaching a depth of about 4 m. As Mr. Murray has pointed out, these are the remains of a Byzantine settlement. This deserted town, the name of which probably still adheres to the locality, must have been a rich and important place, judging from the well-built foundations of large houses scattered everywhere around the place. These ruins could only be superficially studied, but some features are worth mentioning, however. At many places it could be seen that the settlement was stratified in two distinct layers, indicating successive habitation during two subsequent periods. The lack of finds is remarkable: practically nothing except fragments of coarse pottery and tiles, and a few coins were discovered, and even the glazed Byzantine ceramic was rare.

The necropolis was once surrounded with a wall, the traces of which can still be seen above ground in the part near the crag. Three roads lead down from the plateau to the burial ground (see Plan II, 3). Their date, however, as well as that of the water-tunnel mentioned by Mr. Murray, is very uncertain. It seems dangerous to presume that they are contemporary with the necropolis.

Our excavations started in the north-west part of the burial ground, a white spot on Mr.

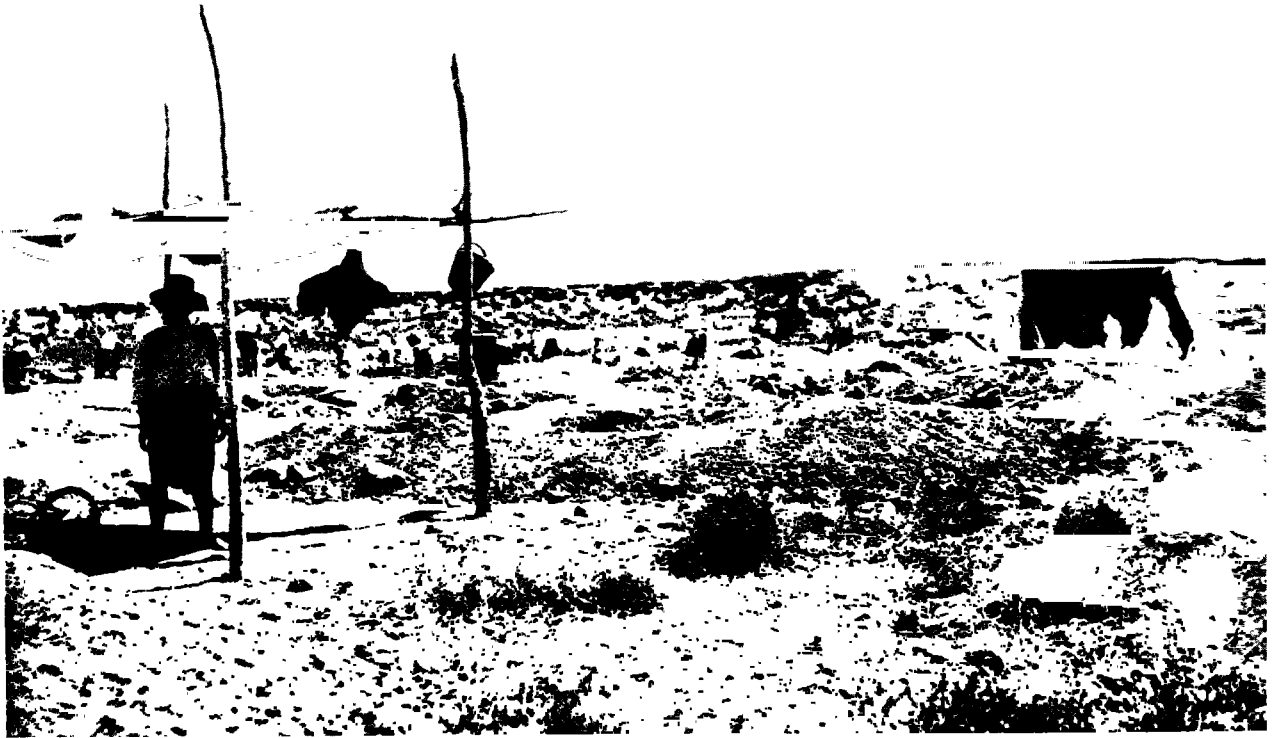

Fig. 187. Enkomi. The necropolis.

Murray's field-map, and our original plan was to drive a series of trial pits from the neighbourhood of Mr. Murray's tomb 69, down to the road leading to Limnia. More than 200 large pits were dug, revealing several tombs, the majority of which, however, had been completely destroyed by the Byzantine houses which here were found very close together. Most of the foundations seem to belong to large, monumental buildings built of large ashlar blocks. Sometimes these foundations were sunk down in the tomb chambers, sometimes the roofs of the caves had been broken through, and the cave used for sanitary purpose. The result here was not very encouraging and the trial-digging was transferred to the neighbourhood of Mr. Murray's tombs 86, 84, and 89 and thence northwards along the road, thus uniting the two trial fields. The British excavations had not touched this place in consequence of the depth of the Byzantine debris and of the difficulties caused by the ground-water rising to the level of the tombs, an experience we shared in our trial pits both here and in the north-west area. The experimental diggings made at the latter place were more successful, and all the best tombs were found there. The excavations were carried out in June and July 1930.

TOMB 1 (Fig. 188: 1, 2)

	SIZE	Diam.	Height
Stomion		0.79	0.52
Chamber		1.69	1.00

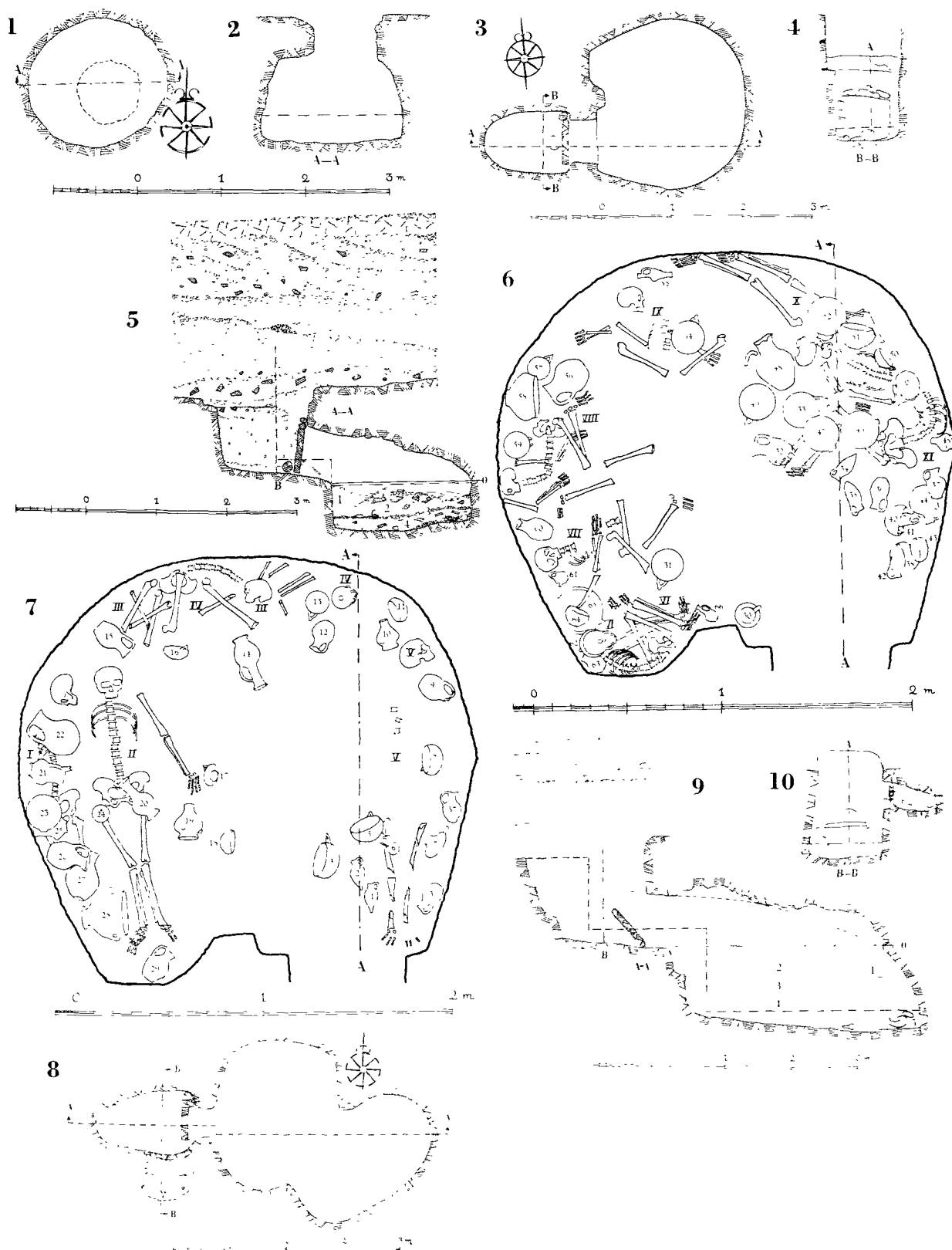

Fig. 188. Enkomi. Tomb 1, Plan (1); Section A-A (2). Tomb 2. Plan (3); Sections B-B, A-A (4, 5); Finds *in situ*, first period (6); second period (7). Tomb 3, Plan (8); Sections A-A, B-B (9, 10).

SHAPE

The tomb was found robbed, and contained nothing but debris from the Byzantine settlement above. It is worth mentioning only on behalf of its peculiar shape. The chamber is circular, and the walls are slightly curved up to a height of c. 1.00 m. where the flat roof starts. The entrance to the tomb is a circular hole in the roof, covered by a stone slab. The same type of tomb was observed at Paleoskoutella, but there it was covered by a low tumulus. If this tomb has also been marked out in a similar way, is a question which the archeological evidence cannot answer, as the Byzantine layers went right down to the rock.

TOMB 2 (Figs. 188: 3—7; 189)

SIZE

	Length	Width	Depth	Height
Dromos	1.65	0.93	1.18	—
Stomion	0.33	0.53	—	0.65
Chamber	2.10	2.43	—	1.15

SHAPE

The dromos of this tomb is a small, oval shaft with roughly vertical sides, and a low step close to the surface of the rock on the short side opposite the entrance. A corresponding cutting can also be traced above the door. The left side of the dromos has been levelled and cut down about 0.20 m. to serve as a base for the foundations of a Byzantine house. The floor slopes gently towards the entrance of the single chamber. This was closed by a stone slab approximately rectangular, and wedged in by smaller stones. The stomion is a short, almost horizontal tunnel, ending in a deep, perpendicular step, leading down to the floor of the chamber. The chamber is irregular, but roughly circular in shape, with perpendicular walls, an unlevelled floor, and a curved roof. The entrance is situated close to the right side-wall, which gives the chamber an asymmetrical appearance.

STRATIFICATION

The surface of the bed-rock was found at a considerable depth, and over it lay stratified debris to a depth of about 2.5 m. in all. This contained principally the remains of buildings in the Byzantine settlement, and is, consequently, of no value for our present investigation. The principle feature is the two distinctly separated floors: the upper one was covered with oblique layers of architectural debris, and the lower one of similar material in horizontal stratification. The layer between the floors was more than 1.00 m. thick, but yielded no finds, except for some sherds of coarse domestic pottery, and no chronological conclusions can be drawn from them.

The dromos of the tomb was filled with *chavara*, which gave the impression of being perfectly intact. Just above the door was a wedge-shaped layer of dark, greenish *chonnos*



Fig. 189. Enkomi. Tomb 2. Interior view.



Fig. 190. Enkomi. Tomb 5.

mixed with some clay. This layer went down to the upper part of the door stone. The builders of the Byzantine epoch cannot possibly have avoided noticing the tomb, as the wall of the house was founded at the levelled edge of the dromos, and it seems probable that the clay and chonnos layer was a filling of a shaft dug by them. It is like a stratum at the back of the dromos, containing sand and poros matter, evidently emanating from the dressing of the building stones. Even if the house builders thus detected the tomb and dug out a part of its dromos, they made no attempt to sack it. The door stone was *in situ*. In the dromos was a bottom layer, c. 0.10 m. thick, of the same matter as the rest of the filling, but of a more compressed consistency. It has to be interpreted as the remains of the original filling, which was left intact at the excavation of the dromos for secondary burials. On account of the considerable depth, at which the tomb was found, the dromos-filling was infiltrated with water, and was compressed to a hard consistency.

Inside the chamber, which was comparatively well preserved, the ground water had permeated from floor and walls, and water covered parts of the deposit. Before we could start the excavation, the water had to be pumped out, and during the work the pump had to be permanently used, in order to prevent the chamber from being refilled. The following stratification was observed: —

- 1) A fan-shaped layer of fine *chavara* material close to the entrance.
- 2) A conical layer of debris from the roof, containing some large pieces of rock.
- 3) A burial layer of culture earth mixed with skeletal remains.
- 4) A compact, horizontal layer of *chavara* and silted clay.
- 5) Another burial layer of the same consistency as Layer 3, resting directly on the floor.

Consequently the tomb has been used in two different periods. Layer 1 is the last earth that has entered the chamber, and has poured in through the door-packing. Layer 2 is thickest in the centre, and it is due to the partial collapse of the roof. Just above the apex of the cone the roof was damaged. Layer 3 represents the later burials, which were

placed on a levelled bed of clay and rocky matter (Layer 4), covering the original burial layer (Layer 5).

To the later burial period belong five skeletons placed along the walls of the chamber. They are numbered from left to right, I—V. To Skeletons I and II belong the tomb-gifts Nos. 17—29, to Skeletons III and IV the finds Nos. 12—16, and to Skeleton V the finds Nos. 1—11. The situations of finds and skeletal remains make it clear that Skeletons III and IV with the finds Nos. 12—16 are older than the rest of the deposit. To judge from the state of preservation, Skeleton V, which was almost destroyed, is older than the two well preserved Skeletons I and II. This being so, we have got a relative chronology for this later burial period, yielding the following sequence: —

- 1) Skeletons III and IV with the finds Nos. 12—16.
- 2) » V » » » » 1—11.
- 3) » I » II » » » » 17—29.

The earlier burial period comprised six skeletons, placed around the walls and numbered from left to right VI—XI. In this group, Skeleton XI together with the finds No. 37 and 42—49 must be later than the rest of the deposit, as it was found on a slightly higher level. Skeletons VI—X with the rest of the finds seem to form a fairly homogeneous group. We should, thus, get a chronological sequence in the earlier burial period, too: —

- 1) Skeletons VI—X with the finds Nos. 30—36, 38—41, and 50—68.
- 2) » XI » » » » 37, 42—49.

BURIALS

In the earlier stratum satisfactory evidence is given as regards the original positions of the dead bodies. Skeleton VI has been sitting in the left corner, facing the centre of the tomb with its legs much contracted. The knees have been elevated, and the arms placed in the bosom. By the gradual decomposition of the dead body, the skeleton has fallen in the position in which it was actually found. The head had fallen to the left and the spinal column slightly forwards in the same main direction, so that the projections of the vertebrae were lying upwards. Skeleton VII has been sitting close to the left side of No. VI in a similar position, but the water has brought some disorder to the bones. The same could be stated for VIII and IX which came next in order around the circular wall of the chamber. Skeleton X differs in its position from the rest of the skeletons in this layer. It was found lying on its back in an almost outstretched position with its arms along the sides. Skeleton XI has been sitting with its back towards the wall in the same position as VI.

In the upper layer Skeletons I and II were lying side by side in dorsal positions with the feet towards the entrance. Skeleton V had the same position, but was in a very poor state of preservation. III and IV were found at the back wall of the chamber. It was evident that they were not *in situ*. They were, apparently, the two older skeletons, removed in order to give space for the later ones.

FINDS (GROUPS: PL. LXXVI, I, 2; TYPES: L. OF PL. II)

1. White Shaved bobbin-shaped bottle with pointed base; cylindrical neck; slightly pinched mouth, and handle from rim to shoulder. Height 16.6. — 52.
2. White Shaved bottle, as No. 1. Height 17.2. — 52.
3. Black Slip III oval jug with flattened base; cylindrical neck; slightly pinched mouth, and handle from rim to shoulder. Height 17.0. — 52.
4. White Slip II hemispherical bowl with in-turned rim, and a wish-bone handle below rim. Slip and decoration obliterated. Piece of rim missing. Diam. 17.8. — 52.
5. White Slip II bowl, as No. 4. Horizontal bands of ladder-pattern around and below rim; similar, vertical decorations from rim to base; chain of rectangular loops below rim; a front ornament of dotted lines; transverse lines on handle. Diam. 17.2. — 52.
6. Monochrome, squat jug with flat base; tall, cylindrical neck; pinched mouth, and handle from rim to shoulder. Grey slip. Height 11.3. — 52.
7. Base-ring II conical bowl with raised rim, and a hooked wish-bone handle below rim. Diam. 16.0. — 52.
8. White Slip II bowl, as No. 4. A ladder-pattern band around rim; similar, vertical decorations from rim to base; two vertical, dotted lines as front ornament. Paint worn. Diam. 14.8. — 38.
9. Black Slip Wheel-made oval jug with flat base; cylindrical neck; ridge below neck, and handle from rim to shoulder. Part of neck missing. Height 18.0. — 38.
10. Levanto-Helladic pear-shaped amphora, with raised base; concave neck; flat rim, and three horizontal handles on shoulder. Black encircling lines around rim, shoulder, and base; a band of curved, vertical lines between handles; black handles. Mat paint; worn. Height 15.1. — 38.
11. Monochrome bowl with flat base; raised, in-turned rim, and a wish-bone handle below rim. Worn, reddish paint; end of handle missing. Diam. 12.1. — 38.
12. Red Slip Wheel-made jug, as No. 9. Height 15.7. — 38.
13. Monochrome bowl, as No. 11. Diam. 11.3. — 38.
14. Base-ring II oval jug with tall, concave neck; flaring rim; a ridge below neck, and handle from neck to shoulder. Horizontal and oblique bands of white lines around neck and body. Height 28.6. — 38.
15. Plain White Wheel-made oval jug with flat base; widening neck; pinched mouth, and handle from rim to shoulder. Height 21.5. — 38.
16. Monochrome bowl, as No. 11. Diam. 12.1. — 38.
17. Monochrome bowl, as No. 11. Diam. 12.1. — 50.
18. Monochrome bowl, as No. 11. Diam. 11.6. — 52.
19. Levanto-Helladic pear-shaped amphora, as No. 10, but with a net-work pattern between handles. Slightly lustrous paint. Height 18.6. — 52.
20. Base-ring II jug, as No. 14. Height 25.5. — 50.
21. White Slip I jug with base-ring; wide neck; flat rim; handle from rim to body, and a horned projection at top of handle. Dots and wavy lines on rim and handle; vertical bands of plain and latticed lozenges on neck; dots and crosses below rim; ladder-patterns in vertical and horizontal bands on body; small groups of plain lozenges in their interstices; crossed lines on base. Height 19.6. — 50.
22. White Painted V oval jug with concave neck; pinched mouth, and handle from rim to shoulder. Encircling lines around rim and neck, and vertical lines from neck to base. A letter on top of handle. Height 28.4. — 42.
23. Plain White Wheel-made plate with base-ring; raised, in-turned rim, and a horizontal, cylindrical string-hole handle on rim. Diam. 18.3. Found on top of No. 25.
24. White Shaved bottle, as No. 1. Height 16.3. — 50.
25. Black Slip Wheel-made squat, conical jug with base-ring; wide, tapering neck; plain rim, and handle from rim to shoulder. Horizontal ridges around neck. Height 18.2. — 52.
26. Red Slip Wheel-made jug, as No. 9. Height 22.4. Found on top of No. 27.
27. Plain White Wheel-made oval jug with flat base; concave neck; pinched mouth, and handle from rim to shoulder. Height 25.8. — 52.
28. Plain White Wheel-made deep crater with raised base-ring; angular outline; flat rim, and two vertical handles on the sides. Height 22.3. — 52.
29. Red Slip Wheel-made jug, as No. 26. Height 18.8. — 52.
30. Plain White Hand-made oval jug with flat base; cylindrical, wide neck; splaying rim, and handle from rim to shoulder. Rim chipped. Height 18.1. Floor.
31. White Slip II bowl, as No. 4. Slip and decoration obliterated. Diam. 16.9. Floor.
32. Plain White Wheel-made jug, as No. 27. Piece of rim missing. Height 20.8. Floor.
33. White Slip I bowl, as No. 4, but with a rounded wish-bone handle. Encircling lines, framing a dotted line around rim; groups of vertical lines from rim to base, and transverse lines on handle. Diam. 19.0. Floor.
34. White Shaved bottle, as No. 1. Height 17.1. Floor.
35. White Shaved bottle, as No. 1. Height 17.1. Floor.
36. Black Slip III oval jug with flattened base; tapering neck; pinched mouth, and handle from rim to shoulder. Paint much worn. Height 17.8. Floor.
37. Oval Hand-made Bucchero jug with base-ring; cylindrical neck; ridge below neck; splaying rim, and handle from rim to shoulder. Fluted body. Height 15.9. — 54.
38. Black Slip III squat jug with flat base; wide, cylindrical neck; splaying rim, and handle from rim to shoulder. A ridge around neck, and a wavy relief-line on shoulder; a projection on top of handle. Projection missing; paint worn. Height 16.0. Floor.
39. White Shaved bottle, as No. 1. Height 16.0. Found in No. 40.
40. White Slip II bowl, as No. 5. Paint worn; piece of rim missing. Diam. 16.2. Floor.
41. Monochrome bowl, as No. 11. Diam. 11.6. Found in No. 40.

42. White Shaved bottle, as No. 1. Height 16.8. — 75.
43. Monochrome bowl, as No. 11. Diam. 12.1. — 75.
44. Plain White Hand-made globular jug with flat base; narrow, cylindrical neck; a relief-line below neck; thick rim, and handle from neck to shoulder. Height 20.5. — 75.
45. Levanto-Helladic amphora, as No. 10. Encircling lines around rim, neck, body, and base; spirals and dots on shoulder; red handles. Mat, red paint; much worn. Height 11.9. — 75.
46. Plain White Wheel-made plate, as No. 23. Diam. 19.4. — 75.
47. Plain White Wheel-made plate, as No. 23. Diam. 19.7. — 75.
48. Plain White Wheel-made jug, as No. 15. Height 29.1. — 75.
49. White Slip II bowl, as No. 4. Encircling bands of ladder-pattern, framing a dotted line around rim; vertical bands of similar pattern from rim to base, and a front ornament of two vertical, dotted lines; transverse lines on handle. Diam. 19.8. — 75.
50. White Slip I shallow bowl with flat base; in-turned rim, and a horizontal handle below rim. Ladder-pattern around rim, and bands of similar pattern and lattice-lozenges from rim to base. Diam. 12.0. Floor.
51. Monochrome bowl, as No. 11, but with raised rim. Diam. 16.5. Floor.
52. White Slip II bowl, as No. 5. Diam. 19.9. Floor.
53. Black Slip II miniature jug with rounded base; cylindrical neck; oblique mouth, and an arched handle from rim to shoulder. Paint obliterated. Height 8.8. Floor.
54. White Slip I bowl, as No. 33. Straight, wavy, and dotted lines in horizontal and vertical direction around rim, and on body; transverse lines on handle. Diam. 17.5. Floor.
55. Base-ring I tall, narrow bottle with cylindrical neck; flat rim; handle-ridge, and handle from neck to shoulder. Paint worn. Height 19.0. Floor.
56. Plain White Wheel-made globular jug with cylindrical neck; pinched mouth; ridge below neck, and handle from rim to shoulder. Height 23.5. Floor.
57. Monochrome bowl, as No. 11. Diam. 12.1. Floor.
58. Base-ring I deep bowl with raised rim, and a hooked wish-bone handle below rim. Diam. 23.2. Floor.
59. Monochrome bowl, as No. 11. Diam. 14.1. Floor.
60. Black Slip Wheel-made oval jug with flat base; cylindrical neck; pinched mouth, and handle from rim to shoulder. Handle and piece of neck missing. Height 19.1. Floor.
61. White Painted V globular jug with flattened base; short, wide, cylindrical neck; arched handle from rim to body, and a tubular spout opposite the handle. Traces of encircling lines around rim and neck, and of vertical lines on body. Height 9.2. Floor.
62. Plain White Wheel-made jug, as No. 15. Height 20.2. Floor.
63. Black Slip Wheel-made jug, as No. 60. Height 13.6. Floor.
64. Monochrome bowl, as No. 11. Diam. 11.7. Floor.
65. Plain White Wheel-made crater, as No. 28. Height 18.0. Floor.
66. Base-ring I globular jug, with tall, tapering neck; funnel-rim; double handle-ridge around neck, and handle from neck to shoulder. Base-ring chipped. Height 12.4. Floor.
67. Cylinder of white faience. On the cylinder is represented a deity sitting on a small chair with crossed legs without back, and holding a staff in his elevated right hand. The end of the staff touches an object placed on a square base. This object is probably a fetish, or perhaps a libation jar. From the left approaches a procession of four adorers. The first of them holds a lyre; his knees are bent which might indicate a dancing movement. The three other adorers are dressed in long gowns and approach the deity with raised arms. Engravings rather worn. Length 1.9. Found in the sieves.
68. Cylinder of steatite. On the cylinder is represented a man standing full-face with his head turned to the left, and his arms bent. The lower section of the cylinder is occupied by four graphical signs. On each side of the man there are bucrania, one of which is flanked by a pair of horns of consecration. The rest of the space is occupied by two designs impossible to interpret. One has the shape of a copper ingot, and the other is composed of three hooked lines. They might be letters. Length 2.0. Found in the sieves.

A distribution of the finds into different classes among the burial periods and their subordinate sections is given in the following diagram: —

		Pottery														Glyptic
		Hand-made							Wheel-made							
		Bl. Sl. II	Bl. Sl. III	Wh. P. V	Base-ring I	Base-ring II	Monochrome	Wh. Shaved	Pl. Wh.	Bucchero	Wh. Sl. I	Wh. Sl. II	Pl. Wh.	Red Sl.	Bl. Sl.	
1st period	1	53	36 38	61	55 58 66	41, 51 57, 59 64	34 35 39	30		33 50 54	31 40 52	32, 56 62, 65		60 63		67 68
	-1	-2	-1	-3		-5	-3	-1		-3	-3	-4		-2		-2
	2					43	42	44			49	46, 47 48			45	
						-1	-1	-1			-1	-3			-1	
2nd period	1				14	13 16						15	12			
					-1	-2						-1	-1			
	2		3		7	6 11	1 2		37		4, 5 8			9	10	
		-1		-1	-2	-2	-1		-1		-3			-1	-1	
	3			22	20	17 18	24			21		23, 27 28	26 29	25	19	
				-1	-1	-2	-1			-1		-3	-2	-1	-1	

CHRONOLOGY

The finds of the earlier part of the first burial period do not comprise any Levanto-Helladic Ware. That is an indication that the earliest burials fall into the Late Cypriote I period. Such pottery occurs from the later part of the first burial period and onwards, but rather rarely. These burials may, therefore, be ascribed to the early part of Late Cypriote II, and as the stratigraphical conditions show that they are but slightly separated from the earliest burials, these ought to be dated to the very end of Late Cypriote I.

TOMB 3 (Figs. 188: 8—10; 191: 1; 192)

SIZE

	Length	Width	Depth	Height
Dromos	1.83	1.10	1.67	—
Stomion	0.38	0.51	—	0.80
Chamber	3.82	3.08	—	1.85
Cupboard	0.71	1.01	—	0.40

SHAPE

The dromos consists of a small, oval shaft widening towards the entrance. The back wall slopes obliquely, and a step is cut in its lower section to facilitate entering the chamber.

The right-hand side is vertical and provided with a small cupboard, closed by a single stone. The opposite long side overhangs, so that the maximum width of the dromos is found at the bottom.

The stomion, leading into the chamber, runs horizontally for a length of about 0.40 m. and then suddenly drops down to the level of the floor by a steep step. The chamber is approximately circular in shape with a large, oval niche, opening on to the right end of the back wall on a level with the floor. The niche is almost of the same size as the rest of the chamber, and therefore the whole tomb is 8-shaped. The floor slopes towards the back wall, and roof and walls form a flat vault, the apex of which is close to the stomion.

STRATIFICATION

Above the level of the rock was a layer of earth, c. 1.80 m. deep, which had accumulated on the top of the tomb in later times, and all of which belonged to the Byzantine settlement. It shows a stratification similar to that mentioned in connection with Tomb 2. The same upper floor-level, covered by a thin layer of dark culture earth, containing coarse Byzantine pottery, was also traceable here. On top of the culture earth were two strata of red and yellow clay, emanating from decomposed, sun-dried bricks. To the earlier Byzantine period belonged a compact layer of stone and earth, which has evidently been the floor of a courtyard. It was covered to the depth of approx. 1.00 m. by horizontally stratified, architectural debris. From the level of this early Byzantine courtyard was dug a shaft, leading right down to the door stone of the tomb, which was found moved and turned back. The shaft contained a dark, loose earth mixed with charcoal and carbonized matter. It also contained some Late Cypriote potsherds. The original filling was found intact at the back of the dromos, and consisted of two layers of *chavara*. The lower one was moist and greenish, and to a great extent mixed with *chommos*. Just below the step in the dromos was a small, wedge-shaped stratum of very hard *chavara* mixed with small stones. The intact portion of the filling shows that the tomb has been used for several burials, and the shaft in front of the door, with the moved door stone that the tomb has been entered and sacked in early Byzantine times. Some earth had fallen through the hole between the door stone and the front wall of the dromos, so that the remaining earth formed a vaulted arch preventing more earth from intruding.

The stratification of the chamber comprised: —

- 1) A thin, horizontal layer of brown, silted clay.
- 2) A compact layer of rock debris, covering most of the chamber except the area close to the back wall of the niche.
- 3) A mixture of *chavara*, clay, and culture earth spread over the whole chamber. It contained skeletal remains and fragmentary tomb-gifts.
- 4) A very thick layer of moist clay mixed with culture earth, containing the bulk of the finds.
- 5) A seemingly intact burial stratum, containing finds and mouldered skeletons. It was covered by a layer of sand, and was limited to the innermost corner of the niche.

The history of the tomb is easily traceable from the stratification. After the plundering in Byzantine times — represented by the Layers 3 and 4 — the roof has partly collapsed (Layer 2), and the debris has gradually been covered over by clay and water, which have poured in through the door (Layer 1). To judge from the abundant finds still left in the tomb, the robbers had worked superficially, but with a frightfully destructive effect. Only a very small section of the tomb (Layer 5) had escaped ransacking. The thin layer of sand, covering this stratum, shows that originally there had been at least two separate burial layers in the tomb. The large amount of finds and their high quality prove that the tomb once was very rich, and contained many bodies.

Of course the levels of the finds, given in the Object Register, have no conclusive value as to their relative date, as none of them are *in situ*. Exceptions to this rule are Finds Nos. 151—155, 156—161, 181—182, 184—197, 202, 204, 211—217, 233—236, and 239 which were all found in the undisturbed layer in the niche. These finds rested directly on the floor, and were consequently a part of the original deposit of the first burial period.

BURIALS

All the skeletal material was either scattered in Layers 3 and 4, or mouldered; nothing can be said therefore about burial customs. To judge from the fragments of bones found, at least fifteen persons had been buried in the tomb.

FINDS (GROUPS: PLS. LXXVI, 3, LXXVII, LXXVIII; TYPES: L. OF PL. II)

Chamber

- | | |
|---|--|
| <ol style="list-style-type: none"> 1. Levanto-Helladic oval jug with flat base; concave neck, and handle from rim to shoulder. Broad, encircling bands around rim, neck, and body; three wavy lines around shoulder, and framed, transverse lines on handle. Lustrous paint. Height 21.5. — 41. 2. Plain White Wheel-made shallow bowl with flat base; in-turned rim, and a string-hole handle on rim. Diam. 10.5. — 43. 3. Monochrome bowl with flat base; raised rim, and a wish-bone handle below rim. Reddish paint; worn and damaged. Diam. 12.1. — 46. 4. Plain White Wheel-made crater with high base-ring; short, wide neck; flat rim, and two handles from rim to shoulder; a marked line between neck and body. Piece of rim missing. Height 27.5. — 64. 5. Monochrome bowl, as No. 3; dark paint. Diam. 15.2. — 35. 6. White Slip I hemispherical bowl with in-turned rim, and a rounded wish-bone handle below rim. A wavy line around rim; bands of parallel lines below rim, and from rim to base. Diam. 18.2. Floor. 7. White Shaved bobbin-shaped bottle with pointed base; cylindrical neck; pinched mouth, and handle from rim to shoulder. Height 17.5. — 70. 8. Levanto-Helladic squat pyxis with flat base; conical shoulder; short, concave neck; out-turned rim, and | <ol style="list-style-type: none"> two horizontal handles on shoulder. Encircling lines around rim, neck, shoulder, and body; a dotted line between handles; painted handles. Lustrous paint; worn. Diam. 10.5. — 70. 9. Levanto-Helladic shallow bowl with flat base; curved outline, and handle from rim to body. Encircling lines round rim and body; concentric circles inside, and painted handle. Red, lustrous paint. Diam. 11.7. — 70. 10. Plain White Wheel-made shallow bowl with flat base, and a horizontal handle below rim. Piece of rim missing. Diam. 11.5. — 70. 11. Levanto-Helladic pyxis, as No. 8, but without dotted line between handles. Dark, lustrous paint. Diam. 9.5. — 70. 12. Plain White Wheel-made bobbin-shaped bottle with base-ring. Neck and handle missing. Height 25.0. — 70. 13. White Shaved bottle, as No. 7. Height 12.5. — 70. 14. Black Slip Wheel-made oval jug with flat base; concave neck; a ridge below neck; pinched mouth, and handle from rim to shoulder. Height 18.2. — 70. 15. Levanto-Helladic shallow bowl with raised base; curved outline, and handle from rim to body. Encircling lines around rim and base; spirals and vertical, wavy lines connected by angular lines below rim. Diam. 12.8. — 70. 16. Plain White Wheel-made plate with base-ring; distinct rim, and a ledge-handle at rim. Diam. 24.1. — 70. |
|---|--|

17. Levanto-Helladic pear-shaped amphora with raised, narrow base; concave, short neck; flaring rim, and three horizontal handles on shoulder. Encircling lines around rim, neck, shoulder, belly, and base; a band of N-shaped ornaments between handles. Handles missing. Lustrous paint; worn. Height 16.7. — 70.
18. Base-ring II conical bowl with concave, angular outline, and raised rim. Handle and pieces of rim missing. Diam. 15.5. — 70.
19. White Shaved bottle, as No. 7. Height 12.1. — 70.
20. White Shaved bottle, as No. 7. Height 13.6. — 70.
21. Plain White Wheel-made plate with base-ring; flat rim, and a string-hole handle below rim. Diam 22.5. — 70.
22. Levanto-Helladic pear-shaped jug with narrow, raised base; narrow neck; splaying, pinched rim, and three handles from rim to shoulder. Encircling lines around rim, neck, body, and base; a band of dots, and short, vertical lines between the handles; painted handles. Red, lustrous paint. Height 14.6. — 95.
23. Lentoid bottle of multi-coloured glass with narrow neck; thick rim, and two handles from neck to shoulder. The ground-colour is bluish white, with yellow incrustations in irregularly curved lines. Piece of base missing. Height 7.2. — 70.
24. Plain White Wheel-made biconical jug with flat base; concave neck; pinched mouth, and handle from rim to shoulder. Height 16.0. — 70.
25. Red Slip Wheel-made oval jug with flat base; concave neck; a ridge below neck; pinched mouth, and handle from rim to shoulder. Rim chipped. Height 14.0. — 70.
26. Fragments of a white and yellow faience bowl. Found on different levels.
27. Red Lustrous Wheel-made tall bottle with base-ring; tall, tapering neck, and handle from neck to shoulder. Height 32.4. — 95.
28. Red Lustrous Wheel-made lentoid bottle with narrow, cylindrical neck; thickened rim; one handle from rim to body, and two vertical handles on shoulder. Incomplete. Height 28.9. — 32.
29. Plain White Wheel-made plate with base-ring, in-turned rim, and a ledge-handle on rim. Diam. 20.3. — 82.
30. Monochrome bowl, as No. 3. Diam. 14.0. Floor.
31. Levanto-Helladic deep crater with high, raised base; bulging sides; wide, concave neck; flat rim, and two handles from rim to shoulder. Broad, encircling lines around neck, body, and base; herring-bone pattern on rim, and a frieze of conventionalized tree-ornaments ("radiating pillars") around belly. Lustrous paint; worn. Height 35.4. — 95.
32. Loom-weight of stone, with a vertical hole through top. Height 6.8. — 80.
33. Levanto-Helladic squat jug with raised base; concave neck; splaying rim, and handle from rim to shoulder. Encircling lines around rim, neck, belly, and base. Height 9.4. — 70.
34. White Shaved bottle, as No. 7. Height 16.8. — 68.
35. Levanto-Helladic squat jug with raised base; narrow, concave neck; flat rim, and two handles from neck to shoulder. Encircling lines around rim, neck, and body; painted handles. Dark, lustrous paint. Height 11.9. — 69.
36. White Slip II almost hemispherical bowl with in-turned rim, and a triangular wish-bone handle below rim. Bands of ladder-pattern around rim, and from rim to base; dotted, vertical lines in their interstices, transverse lines on handle. Piece of rim missing. Diam. 18.6. — 81.
37. Base-ring II oval jug with tall, cylindrical neck; flaring rim, and a flat handle from neck to shoulder; a ridge below neck. Horizontal lines on body and neck; two vertical, incised lines on handle. Height 25.9. — 94.
38. Levanto-Helladic pear-shaped stirrup-vase with high, raised base, and bulging sides. Encircling lines around neck, spout, and body; chevrons on shoulder, and concentric circles on the knob. Base chipped. Dark, lustrous paint. Height 17.9. — 94.
39. Levanto-Helladic shallow bowl with raised base; angular outline, and a horizontal handle below rim. Encircling lines around rim, body, and base; concentric circles inside. Handle missing. Mat paint. Diam. 16.4. — 84.
40. Plain White Wheel-made plate, as No. 29. Diam. 21.5. — 84.
41. Levanto-Helladic cup with flat base; concave sides, and a vertical handle on the side. Encircling lines around rim and body; concentric circles on base. Dark, lustrous paint. Height 5.5. \pm 0.
42. Base-ring II biconical jug with cylindrical neck; flat rim, and handle from neck to shoulder. Two incised lines on handle, and two button-ornaments at its root. Piece of rim missing. Height 11.3. Floor.
43. Levanto-Helladic pear-shaped amphora, as No. 17. Encircling lines around rim, neck, and body; a band of vertical lines between handles. Dark, lustrous paint; much worn. Piece of rim missing. Height 13.4. Floor.
44. Levanto-Helladic cup with base-ring; concave sides, and handle from rim to body. Encircling lines around rim and base; a wavy line around body; painted handle. Dark, mat paint. Height 3.8. Floor.
45. Levanto-Helladic shallow bowl with raised base; curved outline, and handle from rim to body. Encircling lines around rim and base, and concentric circles inside. Dark, slightly lustrous paint; much worn. Diam. 9.7. Floor.
46. Horseshoe-shaped finger-ring of solid gold with an oval bezel. On the bezel is an engraved representation of two winged quadrupeds grouped in a heraldic design round a palm-tree. The design is very conventionalized. Diam. 2.0. Found on top of the disturbed layer.
47. Circular gold earring with overlapping ends, and a round plaque attached to the ring. Diam. 2.0. Floor.

48. Crescent-shaped earring of solid gold with overlapping ends. Diam. 2.0. Floor.
49. Crescent-shaped twisted earring of solid gold with overlapping ends. Diam. 2.5. Floor.
50. Gold earring, as No. 47. Diam. 2.1. Floor.
51. Circular earring of gold with a pendant in granulated work, in the shape of a bull's head. Length 1.7. Floor.
52. Two gold beads. Floor.
53. Globular fluted bead of black faience. Diam. 1.1. Floor.
54. Two gold beads. Found in the sieves.
55. Circular earring of gold with overlapping ends, and a pendant in granulated work. Length 1.4. Found in the sieves.
56. Circular gold leaf used as a nail-head. Found in the sieves.
57. Two gold beads. Found in the sieves.
58. White Shaved bottle, as No. 7. Height 16.7. — 83.
59. Base-ring II jug, as No. 37. Height 21.3. — 91.
60. Plain White Wheel-made jug, as No. 24. Height 22.2. — 96.
61. Red Lustrous Wheel-made lentoid bottle. Neck and handle missing. Height 13.5. — 89.
62. Plain White Wheel-made oblong jug with flat base; concave neck; pinched mouth, and handle from rim to shoulder. Handle missing. Height 15.7. — 78.
63. Plain White Wheel-made plate, as No. 29. Piece of rim missing. Diam. 20.4. — 82.
64. Plain White Wheel-made flat, conical bowl with base-ring; no handle. Piece of rim missing. Diam. 20.9. — 84.
65. Levanto-Helladic shallow bowl with raised base; curved outline, and handle from rim to body. Encircling lines around rim and body; an encircled spiral on bottom. Dark-red, lustrous paint. Diam. 10.7. — 87.
66. Levanto-Helladic amphora, as No. 17. Encircling lines around rim and body, and a running spiral between handles. Piece of rim missing. Dark, lustrous paint. Height 17.1. — 88.
67. Levanto-Helladic amphora, as No. 17; decorated as No. 43. Red, lustrous paint; worn. Height 13.0. — 92.
68. Black Slip Wheel-made oval jug with flat base; concave neck; a ridge below neck; pinched mouth, and handle from rim to shoulder. Piece of rim missing. Height 17.8. Floor.
69. White Shaved bottle, as No. 7. Height 16.3. — 82.
70. Plain White Wheel-made bowl with base-ring, and curved sides. No handle. Diam. 19.7. — 87.
71. Base-ring II squat, globular jug. Two curved relief-lines as front ornament. Part of neck and handle missing. Height 20.0 — 92.
72. Monochrome bowl, as No. 3. Diam. 19.3. — 102.
73. Base-ring II deep, conical bowl with raised rim, and a curved wish-bone handle below rim. Diam. 11.7. Found inside No. 72.
74. Base-ring II squat, globular jug with cylindrical neck; flaring rim; two ridges around neck, and handle from neck to shoulder. Height 23.7. Floor.
75. Base-ring II oval jug with tall, tapering neck; flaring rim with open spout, and handle from neck to shoulder. Two handle-ridges; a ridge below neck, and four curved relief-lines as front ornament. Height 21.3. — 102.
76. Plain White Wheel-made jug, as No. 24. Rim chipped. Height 13.9. Floor.
77. Base-ring II flat bowl with raised rim, and a curved wish-bone handle below rim. Diam. 17.3. Floor.
78. Levanto-Helladic globular stirrup-vase with raised base. Encircling lines around rim, neck, body, and base; transverse lines on shoulder. Knob and handle missing. Red, lustrous paint. Height 10.0. — 89.
79. Levanto-Helladic amphora, as No. 17. Encircling lines around rim, neck, body, and base; a dotted scale-pattern on shoulder. Dark, lustrous paint. Height 11.8. — 100.
80. Two gold beads. Found in the sieves.
81. Fragment of a diadem of gold leaf, ornamented with impressed dots at the edges, and designs in the shape of double-shields in the middle. Length 3.7. Found in the sieves.
82. Two lentoid, fluted paste beads. Diam. 1.9. One spherical, plain paste bead. Diam. 0.9. Found in the sieves.
83. Fragment of a drinking cup of faience in the shape of a female head. Nose and right eye remaining. Black iris, lids, and brow. Length 3.6. Found in the sieves.
84. Circular ivory lid, with a small hole in the centre. A complicated pattern of double volutes, bands, and circles, framed by a hatched band around edge, covers the upper side of the lid. Broken. Diam. 8.7. Floor.
85. Oval ivory disc with two incised lines around edge. Length 6.8. Floor.
86. Rectangular piece of ivory pierced by two holes. Length 4.4. Found in the sieves.
87. Spherical bottle of multi-coloured glass in the shape of a pomegranate. Damaged. Floor.
88. Gold bead. Floor.
89. Piece of a gold mounting, belonging to a cylinder. Diam. 1.5. Floor.
90. Gold bead. Found in the sieves.
91. Two gold beads. Floor.
92. Gold bead. Floor.
93. Gold bead. Found in the sieves.
94. Fragment of plain strip of gold leaf. Length 7.3. Floor.
95. Band-shaped strip of gold leaf with a hole at each end. Length 10.5. Floor.
96. Silver-gilt pin ornamented with egg mouldings in horizontal bands around upper end of shank. The head consists of a plain gold knob, and the shank is provided with an eyelet in the middle. Length 6.7. Floor.
97. Gold bead. Found in the sieves.
98. Small gold mounting in the shape of a socket. Length 0.8. Floor.

99. Flat, circular bead of blue faience. Diam. 1.7. Floor.
100. Fragments of a strip of gold leaf. Length 8.1. Floor.
101. Gold bead. Floor.
102. Flat, circular silver-lead ring. Diam. 1.4. Floor.
103. Thick, circular ivory disc with incised lines around edge. Diam. 7.4. — 98.
104. Fragments of an ivory lid decorated with an incised, plaited band around edge. — 98.
105. Gold bead. — 104.
106. Circular earring of silver-lead. Broken. Diam. 2.3. Floor.
107. Oblong, plain socket of ivory. Incomplete. Length 8.1. — 96.
108. Oval disc of ivory with incised, encircled dots on the upper side. Chipped. Diam. 4.4. — 96.
109. Squat, globular stirrup-vase of faience with base-ring, and indented handles. The vase is decorated in black and white with encircling lines around neck, knob, handles, belly, and base; black dots on white ground on shoulder. Spout missing. Height 9.3. — 93.
110. Gold finger-ring with a large cylindrical mounting in which a seal of paste has been fixed. The ring is decorated with a ridge, and the mounting with impressed circles and lines. Diam. (mounting included) 2.4. Found in the sieves.
111. Wheel-shaped bead of paste with spokes and hub in network. Diam. 1.6. Found in the sieves.
112. Crescent-shaped, circular earring of solid gold with overlapping ends. Diam. 2.6. Found in the sieves.
113. Five paste beads of varying shape. Found in the sieves.
114. Small strip of gold leaf with rounded ends, and a hole at each end. Length 6.1. — 96.
115. Plain White Wheel-made biconical jug with flat base; an impressed line below neck; widening neck; plain rim, and handle from rim to shoulder. Height 17.6. — 78.
116. White Shaved bottle, as No. 7. Height 19.4. — 79.
117. White Slip II bowl, as No. 36. Handle missing. Diam. 17.7. — 83.
118. White Shaved bottle, as No. 7. Height 16.6. — 80.
119. Levanto-Helladic squat, globular stirrup-vase, with encircling lines around neck and body; hatchings on shoulder, and a dot on knob. Neck missing. Red, lustrous paint. Height 10.1. — 84.
120. White Shaved bottle, as No. 7. Height 17.0. — 83.
121. Plain White Wheel-made conical bowl with curved sides; flat base, and an up-turned horizontal handle below rim. Diam. 12.8. — 90.
122. Levanto-Helladic squat, globular jug with base-ring; splaying, concave neck, and handle from rim to shoulder. A red band around rim. Red, mat paint. Height 12.8. — 89.
123. Black Slip III, oval jug with round base; cylindrical neck; stilted, oblique rim, and a raised handle from rim to shoulder. Slip obliterated. Height 10.3. — 74.
124. Base-ring I squat jug with tall, tapering neck; handle-ridge, and handle from neck to shoulder. Two vertical relief-lines as front ornament. Rim, handle, and base-ring missing. Surface worn. Height 15.1. — 76.
125. White Shaved bottle, as No. 7. Rim chipped. Height 15.1. — 76.
126. White Shaved bottle, as No. 7. Height 15.2. — 76.
127. White Slip II hemispherical bowl with in-turned rim, and a rounded, horizontal handle below rim. Bands of parallel lines, framing a horizontal zigzag line with dots in the angles; transverse lines on rim and handle, and vertical bands of parallel lines from rim to base. Diam. 15.3. — 76.
128. White Shaved bottle, as No. 7. Height 17.5. — 70.
129. Circular disc of ivory. Incomplete. Diam. 7.2. — 74.
130. Finger-ring of gold with a circular bezel. The outside of the ring and the bezel are decorated with alternating plain and twisted gold wires. In the centre of the bezel there is a circular cavity, apparently intended for mounting a paste bead. Worn. Diam. 2.0. Found in the sieves.
131. Fragment of a silver-gilt pin, as No. 96. Length 4.2. Found in the sieves.
132. Three spoon-shaped earrings of white gold. Length 1.2. Found in the sieves.
133. Two gold beads. Found in the sieves.
134. Gold bead. Found in the sieves.
135. Gold bead. Found in the sieves.
136. Spiral hair-ring of gold. Broken. Diam. 2.6. Found in the sieves.
137. Fragment of strip of gold leaf. Length 2.1. Found in the sieves.
138. Fragments of a silver ring. Diam. 2.2. Found in the sieves.
139. Crescent-shaped, twisted earring of white gold with overlapping ends. Diam. 1.9. Found in the sieves.
140. Conical ivory socket with incised, straight, semi-circular, and wavy lines. Incomplete. Length 4.0. Found in the sieves.
141. Conical ivory socket, as No. 107. Nine holes at the edge, and incised straight lines below the holes. Incomplete. Length 9.2. Found in the dromos.
142. Fragment of gold leaf decorated with egg mouldings and impressed lines. It has belonged to a silver-gilt pin. Length 3.0. — 81.
143. Two gold beads. — 93.
144. Gold mounting belonging to a cylinder. Diam. 1.2. — 72.
145. Gold bead. — 75.
146. Fragments of a silver bowl. Found in the sieves.
147. Gold bead. — 96.
148. Gold bead. Found in the sieves.
149. Plain circular disc of ivory with two incised lines around the edge. Diam. 5.5. — 83.
150. Strip of gold leaf with rounded ends, and a hole at each end. Length 12.5. — 96.
151. Strip of gold leaf with tapering ends, and a hole at

- each end. Along the edges are impressed dots, forming bordering lines. Length 18.2. Floor.
152. Four gold beads. Floor.
153. Circular earring of gold with a pendant in granulated work. Length 1.4. Floor.
154. Spiral hair-ring of gold. Diam. 1.9. Floor.
155. Crescent-shaped twisted earring of white gold. Diam. 1.6. Found in the sieves.
156. Small strip of gold leaf with a hole at each end. Length 6.2. Floor.
157. Gold strip, as No. 156. Damaged. Length 6.7. Floor.
158. Fragments of a strip of gold leaf, as No. 151. Length 11.3. Floor.
159. Gold bead. Floor.
160. Gold strip, as No. 156. Damaged. Length 10.6. Floor.
161. Fluted, biconical bead of yellow faience. Diam. 2.3. Floor.
162. Gold bead. Found in the sieves.
163. Levanto-Helladic pear-shaped amphora with high, raised base; wide, cylindrical neck; flat rim, and two handles from rim to shoulder. Red neck and base, and encircling lines around lower part of body. Between the handles runs a frieze with a chariot scene. In the chariot are two men in profile, dressed in long gowns hiding their arms. Chariots and dresses are ornamented with dotted lines; the horses are entirely red with white filling paint on the manes and front parts of bodies. Above and below the horses, are chevrons and dotted semicircles as filling ornaments, and between the chariots are vertical flower ornaments in the shape of the so-called Cypriote pillar. Pieces of body missing. Height 45.9. Put together of sherds from different levels.
164. Plain White Wheel-made conical crater with high base-ring; plain rim, and two vertical handles from rim to shoulder. Height 26.2. Put together of sherds from different levels.
165. Levanto-Helladic squat pyxis with flat base; oblique shoulder; splaying rim, and three horizontal handles on shoulder. Encircling lines around rim and shoulder; concentric circles on base, and two bands of large, running spirals around shoulder and body. Reddish, lustrous paint. Height 13.5. Put together of sherds from different levels.
166. White Slip I deep crater with flattened base; wide, tapering neck; stilted rim, and a large, raised wish-bone handle on body. Wavy lines around rim; panel-patterns of vertical, wavy lines, framing dotted lines, around neck; similar patterns of framed, dotted lines and vertical bands of lattice lozenges, flanked by dotted lines, around shoulder and belly; vertical lines from belly to base; a cross of dotted bands on base; transverse, oblique lines; wavy lines, and a dotted band on handle; framed, vertical, dotted bands inside neck. Height 17.2. Put together of sherds from different levels.
167. Gold bead. Found in the sieves.
168. Plain White Wheel-made jug with flat base. Neck and handle missing. Height 14.6. Floor.
169. Red Lustrous Wheel-made bottle with base-ring. Neck and handle missing. Height 21.9. Floor.
170. Levanto-Helladic very squat stirrup-vase with flat base. Button and handles missing. Encircling lines round neck, body, and base. Slightly lustrous paint. Height 7.7. Floor.
171. Plain White Wheel-made jug with flat base, an incised line below neck; concave neck; pinched mouth, and handle from rim to shoulder. Rim chipped; handle missing. Height 20.6. Floor.
172. Base-ring II jug, as No. 74. A ridge around base of neck, and a front ornament of curved relief-lines. Height 24.5. Floor.
173. Base-ring II hemispherical bowl with flat rim, and a string-hole handle at rim. White dots on rim, and irregular, white lines on body. Diam. 11.0. Floor.
174. Base-ring I squat jug with wide, concave neck; mouth covered by a strainer; a tubular spout on shoulder, and an arched horizontal handle on shoulder. Spout missing. Height 10.1. Floor.
175. Plain White Hand-made globular miniature jug with flat base; tapering, wide neck; out-bent rim, and a raised handle from rim to shoulder. Height 7.2. Floor.
176. Plain White Wheel-made plate with base-ring; distinct rim, and a ledge-handle at rim. Diam. 24.4. Floor.
177. Levanto-Helladic shallow bowl with raised base; distinct rim, and handle at rim. Encircling bands outside. Red, mat paint. Rim chipped. Diam. 9.8. — 102.
178. Base-ring I biconical jug with cylindrical, wide neck; flat rim, and a ridge around neck. Chipped; handle missing. Height 9.0. Floor.
179. White Slip I bowl, as No. 6. A dotted line around rim; bands of minute ladder-pattern below rim, and from rim to base; bands of lattice lozenges in the interstices, and transverse lines on handle. Diam. 17.4. Floor.
180. White Slip I bowl, as No. 6. A framed, wavy line around rim, and bands of parallel lines from rim to base; transverse lines on handle. Diam. 19.3. Floor.
181. Plain White Hand-made jug, as No. 175. Handle missing. Height 7.9. Floor.
182. Base-ring II bowl, as No. 18. Diam. 14.8. Floor.
183. Levanto-Helladic amphoriskos, as No. 17; decorated as No. 43. Dark, slightly lustrous paint; worn. Height 10.1. Found in No. 182.
184. Female, naked idol of terracotta with flat head; hooked nose; large ears; round button-shaped eyes; thick neck; conical breasts; arms to the sides, and straight legs. Black hair and abdomen. Genitalia abnormally large, and marked with three lines, forming a triangle. Length 18.8. Floor.
185. White Shaved bottle, as No. 7. Height 18.3. Floor.
186. Black Slip III jug, as No. 175. Paint worn. Height 9.5. Found inside No. 187.

187. White Slip II shallow bowl with flattened base, and a string-hole handle at rim. Horizontal lines around rim, and bands of vertical lines from rim to base; short, horizontal lines in their interstices, and transverse lines on rim. Diam. 12.6. — 103.
188. Plain White Wheel-made bobbin-shaped bottle, as No. 12. Neck and handle missing. Height 27.8. Found on top of No. 189.
189. Base-ring II bowl, as No. 18. Diam. 16.8. Found on top of No. 190.
190. Plain White Wheel-made shallow bowl with base-ring; distinct rim, and a ledge-handle below rim. Diam. 23.3. Found on top of No. 191.
191. Plain White Wheel-made shallow bowl with base-ring; rounded sides, and plain rim. No handle. Diam. 26.3. Floor.
192. Monochrome bowl, as No. 3. Diam. 11.5. Floor.
193. Base-ring I small, globular jug with tall, narrow neck; funnel-rim, and handle from neck to shoulder. A double handle-ridge, and curved relief-lines on body. Piece of handle missing. Height 10.6. Floor.
194. Base-ring I jug, as No. 193. Two ridges around belly. Height 15.1. Floor.
195. Base-ring II jug, as No. 74. Height 26.0. Floor.
196. Plain White Wheel-made shallow bowl with base-ring, and a string-hole handle at rim. Diam. 13.2. Floor.
197. Levanto-Helladic bowl, as No. 15. Diam. 11.4. Floor.
198. Small strip of gold leaf with rounded ends, and a hole at each end. Length 7.9. Floor.
199. Plain, oval disc of ivory with a decoration of incised, concentric semicircles on the edge. Diam. 4.9. Floor.
200. Red Lustrous Wheel-made narrow bottle with base-ring; tall, tapering neck; flat rim; handle-ridge, and handle from neck to shoulder. Height 24.7. Floor.
201. Red Lustrous Wheel-made bottle, as No. 200. Height 34.5. Floor.
202. Base-ring II jug, as No. 37. Bands of vertical, white lines on body. Pieces of rim and neck missing. Height 29.0. Floor.
203. Base-ring I jug, as No. 193. Height 12.6. Floor.
204. Black Slip Wheel-made oval jug with flat, broad, concave neck; pinched mouth, and handle from rim to shoulder. Rim and handle missing. Paint worn. Height 16.3. Floor.
205. Monochrome oval jug with round base; tapering neck; ridge below neck; pinched mouth, and handle from rim to shoulder. Height 14.7. Floor.
206. Plain White Wheel-made bowl, as No. 191. Diam. 26.5. Floor.
207. Plain White Wheel-made bowl, as No. 191. Diam. 19.8. Floor.
208. Levanto-Helladic shallow bowl with raised base; curved outline, and handle from rim to body. Encircling lines around rim and base, and a band of V-shaped ornaments below rim. Dark, lustrous paint. Diam. 11.9. Floor.
209. Oval Hand-made Bucchero jug with base-ring; cylindrical neck, splaying rim, and handle from rim to shoulder. Horizontal ridges around neck, and fluted body. Height 15.6. Floor.
210. Levanto-Helladic amphoriskos, as No. 17. Encircling lines around rim, neck, body, and base; spirals between handles. Dark, slightly lustrous paint. Height 14.5. Floor.
211. Plain White Wheel-made oblong bottle with base-ring; tall, narrow neck; wide, flat rim, and handle from neck to shoulder. Height 17.9. Floor.
212. White Shaved bottle, as No. 7. Height 16.3. Floor.
213. White Shaved bottle, as No. 7. Height 16.3. Floor.
214. Plain White Wheel-made bobbin-shaped bottle with base-ring; short, concave neck; collar-rim, and handle from neck to shoulder. Height 36.1. Floor.
215. Fragments of a Red Lustrous Wheel-made jug. Floor.
216. Levanto-Helladic shallow bowl with flat base; bulging sides; small, flat rim, and handle from rim to body. Encircling lines around rim and body; dots on rim, and an encircled spiral inside. Red, lustrous paint; handle missing. Diam. 10.5. Floor.
217. Black Slip Wheel-made jug, as No. 14. Rim chipped. Height 18.3. Floor.
218. Plain White Wheel-made jug, as No. 14. Rim chipped. Height 19.5. Floor.
219. Base-ring II jug, as No. 37, but with handle from rim to shoulder. Handle missing. Height 16.4. Floor.
220. White Slip II bowl, mainly as No. 36. Two bands of ladder-pattern, framing a dotted line around rim; bands of the same pattern from rim to base, and a front ornament of similar, vertical bands, and dotted lines; transverse lines on handle. Diam. 16.5. Found inside No. 221.
221. White Slip I bowl, as No. 6. A wavy line around rim; bands of parallel lines below rim, and from rim to base; transverse lines on handle. Diam. 19.4. Floor.
222. Plain White Wheel-made small bowl with flat base; no handle. Diam. 9.5. Floor.
223. Monochrome squat jug with flat base; concave, tall neck; pinched mouth; ridge below neck, and an arched handle from rim to shoulder. Two curved relief-lines as front ornament. Height 23.3. Floor.
224. Base-ring II jug, mainly as No. 42. Height 11.1. Floor.
225. Base-ring II jug, as No. 74. Height 27.7. Floor.
226. White Shaved bottle, as No. 7. Handle missing. Height 17.2. Floor.
227. White Shaved bottle, as No. 7. Height 13.6. Floor.
228. White Shaved bottle, as No. 7. Height 18.9. Floor.
229. Black Lustrous Wheel-made oval jug with base-ring; tall, concave neck, and handle from neck to shoulder. Horizontal ridges around neck and shoulder. Height 26.6. Floor.
230. Badly corroded fragments of a bronze dagger with solid handle. Floor.
231. Fragments of a bronze dagger, as No. 230. Floor.
232. Fragments of a bronze dagger, as No. 230. Floor.

233. Gold bead. Floor.
 234. Gold bead. Floor.
 235. Narrow strip of gold leaf with slightly convex sides, and rounded ends; a hole at each end. Decorated with bands of impressed hatchings and zigzag lines. Length 12.3. Floor.
 236. Plain strip of gold leaf. Length 12.4. Floor.
 237, 238. Circular disc of ivory with a hole in the centre. Decorated with a framed, incised band of curved lines round the edge, and several scratchings in the centre. Diam. 7.0. Put together from pieces found on different levels.
 239. Circular lid of ivory with a flat, thin edge, and three groups of three holes inside the edge for fixing the lid. Decorated with a wheel-ornament on one side. Chipped. Diam. 6.3. Floor.
 240. Ivory pin, with a head in the shape of a pomegranate, and the end decorated with incised lines. Probably used as a spindle. Length 23.7. Floor.
 241. Ivory pin, as No. 240. Length 23.7. Floor.
 242. Fragments of small strip of gold leaf. Found in the sieves.
 243. Eight gold beads. Found in the sieves.
 244. Two gold beads. Found in the sieves.
 245. Seven gold beads. Found in the sieves.
 246. Two gold beads. Found in the sieves.
 247. A fragment of gold leaf, and a piece of twisted gold wire. Found in the sieves.
 248. Six paste beads and one bead of cornelian. Found in the sieves.

Supplementary catalogue

249. White Slip I bowl, as No. 6, but with a front ornament of vertical, dotted, and wavy lines. Incomplete. Diam. 19.3.
 250. White Slip I bowl, as No. 6. A wavy line around rim; a framed band of lozenges below rim; vertical lines from rim to base; transverse lines on handle, and a front ornament of vertical, dotted, and wavy lines. Pieces of base missing. Diam. 19.7.
 251. White Slip I bowl, as No. 6; decorated as No. 250. Pieces of rim missing. Diam. 19.5.
 252. White Slip II shallow bowl with round base, in-turned rim, and a wish-bone handle below rim. A framed band of lattice lozenges around rim; vertical bands of parallel lines from rim to base; lattice lozenges round body, and transverse lines on handle. Diam. 18.5.
 253. White Slip II bowl, as No. 36. Handle missing. Diam. 19.7.
 254. White Slip II bowl, as No. 220, but with a chain of hooked loops, instead of a dotted line. Diam. 18.2.
 255. White Slip II bowl, as No. 254. Diam. 17.7.
 256. White Slip II bowl, as No. 254. Diam. 18.5.
 257. Levanto-Helladic amphora, as No. 163. Red painted base and neck; a running spiral on rim; vertical bands on handles, and encircling lines around lower part of body. Between the handles runs a frieze of four chariots, all of the same type, as those of No. 163. Between the chariots are tall, vertical flower ornaments, resembling the so-called Cypriote pillar, and below the handles are palm-tree ornaments. Pieces of body missing. Paint worn. Dark-red, lustrous paint. Height 48.5.
 258. Levanto-Helladic amphora, as No. 163. Red painted base and neck; transverse and hooked lines on rim; vertical bands on handles, and encircling lines around lower part of body. Between the handles runs a frieze with chariot scenes. The chariots and the horses are mainly of the same types, as those of No. 163, but the charioteers have broad caps and the driver has a gown which leaves his arms and hands free. From the reins hang fringes. Behind the chariot stands a male figure in profile, with his back turned, placing his left hand on the chariot. He is dressed in the tight clothes and a cap, as worn by the charioteers, and his pose is characteristic of most of the standing male figures on vases of this class. The legs are muscular and his movement is vividly marked. The breast is high, and curved forwards, and the neck is placed abnormally close to the back. In front of the horse are two male figures of the same type as the above described, leading the horse. Spirals, radiating pillars and conventionalized nautilus shells serve as filling ornaments. The paint is obliterated on one side of the vase. Dark-red, lustrous paint. Height 74.5.
 259. Levanto-Helladic amphora, as No. 163. Dark painted neck; encircling lines around belly and base; groups of transverse lines on rim, and vertical bands on handles. On the shoulder is a frieze of water birds with necks curved back; large, globular eyes; flat beaks, and network pattern on the bodies. Below the birds are groups of wavy lines, suggesting the waves of the sea. Paint partly worn. Some pieces of body missing. Height 39.4.
 260. Levanto-Helladic amphora, as No. 163; decorated as No. 259. The birds have all a group of three wavy lines on the back. Chevrons serve as filling ornaments and the rim is decorated with a herring-bone pattern. Incomplete. Height 32.7.
 261. Levanto-Helladic amphora, as No. 163. Dark painted neck and base; groups of transverse lines, and hooked triangles on rim; encircling lines around body, and vertical bands on handles. On the shoulder is a frieze with two chariots. One chariot is occupied only by a driver dressed in a gown which leaves his arms and hands free. He has a small, flat cap on his head, and the chariot is drawn by two horses. In front of the chariot stands a male figure in the characteristic pose, and dressed in tight clothes. He wears a very elaborate head-dress, consisting of a flat cap with a curved plume on the top, and a richly ornamented back resembling a short veil. The outlines of the upper part of the body are dotted and probably suggest long hair and

- beard. His profile is clear with a straight, pointed nose, and a large, circular eye. The other chariot is occupied by two men, dressed in long gowns, and with small head-dresses, resembling diadems. The rich filling decoration consists of flowers and pillar ornaments. Dark, lustrous paint. Base, and pieces of body missing. Height 44.2.
262. Levanto-Helladic amphora, as No. 163. Dark-red painted base and neck; encircling lines around lower part of body, and groups of transverse lines on rim. Around shoulder and belly runs a broad, figured frieze with nautical scenes. A ship with high stems, decorated with hooked projections, and a mast in the centre, ending in six loops, is the central decoration on each side of the body. The ships are decked and below the decks are four small, male figures in a position which suggests either rowing, or hoisting the sails. On deck stand two big male figures with long, fluttering hair, each of them holding a steering-oar. On one side of the vase, another male figure dressed in a pointed helmet ending in a curved top, stands on shore pushing away the ship; on the other side the corresponding figure holds a steering-oar. On the prow of one of the ships sits a bird. The dresses of the small male figures are of the tight, tunic type. The men with the steering-oars are dressed in long gowns, decorated with dots. Dotted circles and conventionalized nautilus shells serve as filling ornaments. The vase is very fragmentary, and both handle, pieces of neck, and one third of body are missing. Red lustrous paint. Height 46.8.
263. Levanto-Helladic amphora, as No. 163, but with indented base, and very bulging sides. Encircling lines around rim, neck, body, and base; transverse lines on rim, and a broad, vertical lattice band below each handle. Shoulder and belly are decorated with a close shell-pattern, and around neck runs a broad, wavy line. The ware is coarse, the slip gritty white, and the paint mat red. Pieces of upper part missing. Height 41.0.
264. Levanto-Helladic amphora, as No. 163. Dark painted neck and rim; encircling lines on rim, and around lower part of body; vertical bands on handles. The shoulders are covered with fan-shaped ornaments and concentric semicircles. Fragmentary. Dark-red, lustrous paint. Height 33.6.
265. Levanto-Helladic shallow bowl with profiled rim, and a small, horizontal handle on rim. Encircling lines outside, and framed bands of lozenges inside. Incomplete. Red, lustrous paint. Diam 22.1.
266. Levanto-Helladic amphora, as No. 17. Encircling lines around rim, neck, and body; vertical lines between handles. Incomplete. Red, lustrous paint. Height 15.2.
267. Levanto-Helladic amphora, as No. 17, but with three vertical handles on shoulders. Encircling lines around rim, neck, and body; a scale-pattern between handles. Incomplete. Red, lustrous paint. Height 20.4.
268. White Painted Wheel-made deep, biconical crater, with high base-ring; flat rim, and two horizontal handles on body. Two broad zigzag lines around body. Handles and piece of body missing. Height 22.7.
269. White Painted Wheel-made oval jug with flat base; slightly concave neck; pinched mouth, and handle from rim to shoulder. An encircling line around neck, and crossed, irregular lines on body. Pieces of body and rim missing. Height 35.0.
270. Plain White Wheel-made oval jug with flat base; narrow, concave neck; thick, splaying rim, and handle from neck to shoulder. Piece of body missing. Height 21.5.
271. Red Lustrous Wheel-made bottle with narrow base-ring; thin body; tall, tapering neck; wide, flat rim, and handle from neck to shoulder. Rim chipped. Height 36.4.
272. Levanto-Helladic amphora, as No. 163. Dark painted neck and base; encircling lines around lower part of body; groups of transverse lines on rim, and vertical lines on handle. Chariots scenes around the shoulder. Paint almost obliterated. An incised letter on the base. Dark, lustrous paint. Height 46.5.
273. Bull-shaped vase of Base-ring Ware with large disc-shaped eyes; holes through snout and neck, and a basket-handle from neck to back. Horns missing. Length 14.6.
274. Base-ring II jug, as No. 75. Handle missing. Height 14.0.
275. Base-ring I jug, as No. 193. Handle and pieces of rim and body missing. Height 9.7.
276. Fragments of a Levanto-Helladic amphora, as No. 163. Red painted neck; encircling lines around lower part of body, and groups of transverse lines on handle. Chariots scenes and Cypriote pillars in rather careless execution around shoulders and belly. Dark, lustrous paint.
277. Fragments of a Levanto-Helladic amphora, as No. 163. Dark-red painted neck; encircling lines around lower part of body, and groups of herring-bone pattern on rim. Around shoulder and belly runs a frieze with chariot scenes. Only one half of the frieze is preserved, and shows an exceptionally small chariot drawn by two horses, and occupied by three men; the driver holds a whip in his left hand. Chariots and dresses are decorated with dotted lines. In front of the missing chariot stand two men, stretching out their arms towards the horses. They are standing in the characteristic pose of the free figures on vases of this class. The manes and heads of the horses are painted with white filling paint, and the short kilts of the standing men are marked with crossed, white lines around their waists. Pillar ornaments and concentric lozenges serve as filling ornaments. Dark-red, lustrous paint.
278. Fragments of a Levanto-Helladic amphora, as No.

163. Red painted neck; encircling lines around lower part of body; groups of transverse lines on rim, and vertical bands on handles. Ornaments resembling conventionalized drawings of algae around shoulder. Red lustrous paint.
279. Base-ring I deep, crater-shaped bowl with wide neck; splaying rim, and a high, knobbed wish-bone handle on shoulder. A horizontal ridge between neck and shoulder, and a wavy line in relief around body. Height 21.8.
280. Base-ring II oval jug with cylindrical neck; splaying rim, and handle from neck to shoulder. The rim is provided with a spout, flanked by two up-standing, ear-shaped excrescences. The neck is decorated with three horizontal, incised ridges, and the body with two spirally curved, incised relief-lines; on the handle are vertical, incised lines, alternating with vertical ridges. Surface slightly worn. Height 38.6.
281. A necklace made up from the gold beads Nos. 52, 54, 57, 80, 88, 90, 91, 92, 94, 97, 101, 105, 133, 134, 135, 143, 145, 147, 148, 152, 159, 162, 167, 243, 244, 245, 246. As the beads were found both in the

sieves and at different levels in the disturbed layers, the composition of the necklace is arbitrary.

Dromos cupboard

1. Base-ring II conical bowl with raised rim, and a curved wish-bone handle below rim. Piece of handle missing. Diam. 10.5. Floor.
2. Base-ring I small, squat jug with tall, tapering neck; funnel-rim, and handle from neck to shoulder. Curved relief-lines as front ornament. Rim and handle missing. Height 12.1. Floor.
3. White Shaved bottle with pointed base; cylindrical neck; pinched mouth, and handle from rim to shoulder. Height 18.3. Floor.
4. White Slip II hemispherical bowl with in-turned rim, and a triangular wish-bone handle below rim. Bands of ladder-pattern around rim, and from rim to base; vertical dotted lines in their interstices. Diam. 13.5. Floor.
5. Base-ring II bowl, as No. 1. Diam. 17.8. Floor.
6. Circular ring of silver-lead. Broken. Floor.
7. Circular ring of bronze with overlapping ends. Diam. 4.1. Floor.

The Object Register is summed up in the diagram on the opposite pages.

CHRONOLOGY

The tomb is difficult to date in consequence of the lack of good stratigraphical evidence. Of the intact bottom layer there was only a fragment left, but the presence of the Levanto-Helladic pots, Nos. 197 and 216, are still sufficient a proof to allow us to assign this layer to Late Cypriote II. The disturbed layers did not contain anything that indicated a later date than Late Cypriote II, but the small objects and the large vases of Levanto-Helladic Ware are of fairly advanced types. The earlier layer probably belongs to the first part of the period, and the later finds to its middle.

		P o t t e r y														Bronze			
		H a n d - m a d e							W h e e l - m a d e										
		Bl. Sl. III	Monochrome	Wh. shaved	Pl. Wh.	Bucchero	Base-ring I	Base-ring II	Wh. Sl. I	Wh. Sl. II	Bl. Sl.	R. Sl.	R. Lustrous	Bl. Lustrous	Wh. P.	Pl. White	Levanto-Helladic	Daggers	Ring
Intact bottom layer		186	192	185	181		193	182		187	204		215		188	197			
				212			194	189			217				190	216			
				213				195							196				
								202							191				
															211				
															214				
		-1	-1	-3	-1		-2	-4		-1	-2		-1		-6	-2			
Disturbed layers	123	3	7	175	209	124	18	6	36	14	25	27	229	268	2	4	1, 8, 9	230	
		5	13			174	37	166	117	68		28		269	10, 12	11, 15	231		
		30	19			178	42	179	127			61		270	16, 21	17, 22	232		
		72	20			203	59	180	220				169		24, 29	31, 33			
		205	34			275	71	221	252				200		40, 47	35, 38			
		223	58			279	73	249	253				201		60, 62	39, 41			
			69				74	250	254				271		63, 64	43, 44			
			116				-6	75	251	255					70, 76	45, 65			
			118					77	256						115, 121	66, 67			
			120					172	-8						164, 168	78, 79			
			125					173		-9					171, 176	119, 122			
			126					219							206, 207	163, 165			
			128					224							218, 222	170, 177			
			226					225							270	183, 208			
			227					274								210, 257			
			228					280								-27	258, 259		
																260, 261			
																262, 263			
																264, 265			
																In fragm. approx. 25	266, 267		
															272, 276				
															277, 278				
		-1	-6	-16	-1	-1	-26	-66	-16	-21	-2	-1	-7	-1	-3	-52	-45	-3	
Dromos cupboard			3			2	1, 5		4										7
			-1			-1	-2		-1										-1

TOMB 4 (Fig. 191: 2—5)

SIZE

	Length	Width	Depth	Height
Dromos	1.47	0.71	0.95	—
Stomion	0.18	0.47	—	0.58
Chamber	1.10	0.94	—	1.00

SHAPE

The dromos of the tomb is an oblong shaft with rectangular corners, vertical long sides, and a sloping back wall, provided with a step in its lower section. The floor slopes slightly

Silver-lead	Silver										Gold										Terra-cotta	Faience			Glass	Stone		Ivory	
Rings	Pins	Earrings	Fragments	Hair-rings	Earrings	Finger-rings	Leaf	Strips	Diadem	Mountings	Nail-head	Beads	Fragments	Idols	Beads	Bowl	Vase	Cup	Bottles	Loom-weight	Beads	Pins	Discs	Varia					
				154	153			151				152		184	161									239					
								156				152																	
								157				152																	
								158				152																	
								160				159																	
								235				233																	
								236				234																	
				-1	-1			-7				-7		-1	-1									-1					
102	96	155	138	136	47	46	142	94	81	89	56	52. 52. 54	247	273	53	26	109	83	23	32	248	240	84	86					
106	131		146		48	110		95		98		54. 57. 57			82				87		248	241	85	107					
	148				49	130		100		144		80. 80. 88			82								103	140					
					50			114				90. 91. 91			82								104	141					
					51			137				92. 93. 97			99								108						
					55			150				101. 105			111								129						
					112			198				133. 133			113								149						
					132			242				134. 135			113								199						
					132							143. 143			113								237						
					132							145. 147			113								238						
					139							148. 162			113														
					155							167. 243			161														
												243. 243			248														
												243. 243			248														
												243. 243			248														
												243. 244			248														
												244. 245			248														
												245. 245			248														
												245. 245																	
												245. 245																	
												246. 246																	
-2	-3	-1	-2	-1	-12	-3	-1	-8	-1	-3	-1	-47	-1	-1	-18	-1	-1	-1	-2	-1	-2	-2	-10	-4					
6																													
-1																													

towards the door. The door-packing consists of a flat slab in oblique position, wedged by some smaller stones at its upper end. The stonion is a short tunnel, ending in an abrupt step, leading down to the chamber floor. The plan of the chamber is oval, its walls are vertical, and the roof slightly curved.

STRATIFICATION

The masses of earth, covering the natural rock to a depth of more than 2.00 m., consisted of Byzantine debris, mainly of the same stratification as that observed above the previous tombs. The Byzantine epoch was represented here, too, by two layers. The lower Byzantine floor started from a wall, founded on the rock, close to the edge of the dromos. The wall was carefully built of dressed, regular poros blocks. Above the floor rested a layer of

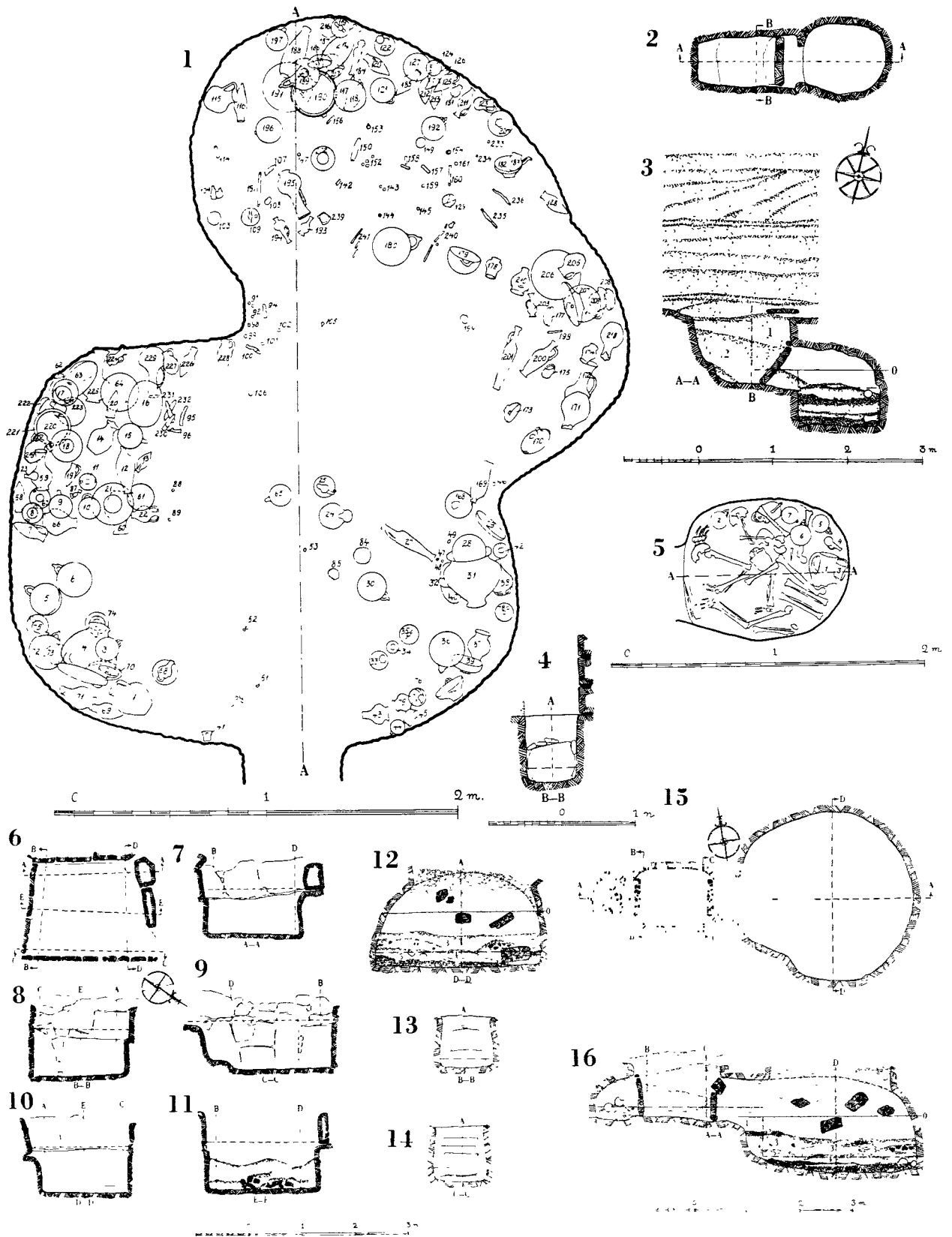

Fig. 191. Enkomi. Tomb 3, Finds *in situ* (1). Tomb 4, Plan (2); Sections A-A, B-B (3, 4); Finds *in situ* (5). Tomb 5, Plan (6); Sections A-A, B-B, C-C, D-D, E-E (7, 8, 9, 10, 11). Tomb 6, Sections D-D, B-B, C-C (12, 13, 14); Plan (15); Section A-A (16).

debris from the building — about 1.00 m. thick — stratified horizontally in five different strata. On top of this was a second Byzantine floor of sand and pebbles, covered by obliquely stratified architectural debris.

The stratification of the dromos was intact. The filling consisted of: —

- 1) A layer of grey *chavara*, thickening towards the door.
- 2) A moist layer of broken rock consisting of *chavara* and *chonnos*.
- 3) A small layer of white, hard *chavara* just below the step in the back wall of the dromos.

The stratification indicates that the tomb had been used in at least two different periods, and Layer 3 was the remainder of the original dromos-filling. The chamber was filled with earth up to the level of the threshold and the filling was stratified as follows: —

- 1) A fan-shaped layer of fine rock material close to the door.
- 2) A layer of eroded rock, covering the whole chamber.
- 3) A burial stratum, covering the whole area.
- 4) A layer of silted clay and debris from the roof.
- 5) A dark layer of silted culture earth.
- 6) A burial stratum, resting directly on the floor.

The interpretation of the stratification is clear. The chamber has been occupied by burials in two different periods. The earlier is represented by Layers 5 and 6, in which were found the remains of two skeletons and pots Nos. 3—7. The high level of No. 3 is caused by the clay and water (Layers 4 and 5) which have poured into the tomb through the stonion. On this layer, the secondary burials took place. Two skeletons were found in a fragmentary condition, and the pots Nos. 1 and 2.

BURIALS

The four skeletons found in the tomb have all been deposited in contracted positions. The limited space in the chamber, as a matter of fact, makes such positions necessary. The tomb as a whole was very poor and the burial-gifts of little importance.

FINDS (GROUP: PL. LXXIX, I; TYPES: L. OF PL. II)

- | | |
|--|--|
| <ol style="list-style-type: none"> 1. Plain White Wheel-made oval jug with tall, concave neck; flat rim, and handle from rim to shoulder. Base missing. Height 22.6. — 43. 2. Monochrome bowl with flat base; raised rim, and a wish-bone handle below rim. Reddish paint. Diam. 11.2. — 38. 3. Black Lustrous Wheel-made jug, as No. 1; ridges around and below neck. Height 21.9. — 70. | <ol style="list-style-type: none"> 4. Black Slip III squat jug with flat base; tall, tapering neck, funnel-rim, and handle from neck to shoulder. Incised, parallel zigzag and straight lines around the body. Broken. Floor. 5. Monochrome bowl, as No. 2. Diam. 11.7. Floor. 6. Monochrome bowl, as No. 2. Diam. 14.0. Floor. 7. Monochrome bowl, as No. 2. Handle missing. Diam. 11.6. Floor. |
|--|--|

Summing up the Object Register and distributing the finds between the two burial periods, we obtain the following diagram:

	P o t t e r y				
	H a n d - m a d e		W h e e l - m a d e		
	Bl. Sl. III	Monochrome	Pl. Wh.	Bl. Lustrous	
1st burial	4 -1	5. 6. 7 -3		3 -1	
2nd burial		2 -1	1 -1		

CHRONOLOGY

The finds are few, but sufficient to give a fairly definite date of the burials. The four Monochrome bowls are all of an early type. Pot No. 4 is of a Middle Cypriote class. This assigns the first burial to the very beginning of Late Cypriote I. The second burial is not very much later; in any case, it belongs to the same period.

TOMB 5 (Figs. 190; 191:6—10)

SIZE

Length of shaft	2.50 m.
Width » »	1.82
Depth » »	1.46

SHAPE

The tomb belongs to the great number of tombs in this necropolis, which have been thoroughly robbed in the Byzantine epoch. It is only recorded here because of its peculiar shape.

A rock-cut, roughly rectangular shaft, the sides of which were faced with masonry of flat irregular stones, forms the tomb chamber. To facilitate entrance of the shaft, a sloping staircase of two steps was cut in the N. W. corner. The masonry was founded on a rock-cut ramp, about 1.00 m. high, except for the W. side, where it was founded directly on the rock floor. To judge from the projecting ramp, the tomb shaft has probably been covered by large stone slabs resting on the ramp, but they have been removed by the robbers.

STRATIFICATION

The earth, filling the shaft, was mixed, and without regular stratification. *Chavara* and sand mixed with clay and stones, and here and there, small streaks of culture earth showed

that the work of the robbers had been thorough. No finds were made in the tomb except for some fragments of a bronze bowl, and pieces of a stone mortar, sufficient to ascertain, that the tomb dates from Late Cypriote times.

TOMB 6 (Figs. 191: 12—16; 194: 1)

SIZE

	Length	Width	Depth	Height
Dromos	1.69	0.99	1.06	—
Stomion A	0.42	0.62	—	0.80
Chamber A	3.28	3.15	—	c. 1.75
Stomion B	0.15	0.47	—	0.75
Chamber B	0.62	0.88	—	0.80

SHAPE

The dromos of the tomb is an oblong shaft of small dimensions. The greatest width is not at the surface but some 0.30—0.40 m. above the floor. The transverse section forms, therefore, a slightly sack-shaped figure. The floor is roughly horizontal. Two chambers open from the short sides, an eastern one, A, and a western one, B.

Chamber A has a small, rounded door, closed by three stones. The central stone was a flat slab, resting on a low threshold block and surmounted by a rectangular, oblong stone. The stomion is tunnel-shaped, and starts with a gentle slope. Its inner part consists of a deep step, leading down to the chamber floor. The plan of the chamber is roughly circular and the floor is almost horizontal. The roof was fallen in, but it can safely be reconstructed as a flat vault of the usual type.

Chamber B is a very small, oval chamber, closed by two flat blocks of calcareous stone. The stomion is short and narrow, and the chamber is approximately on the same level as the dromos floor.

STRATIFICATION

As the tomb was entirely collapsed, the excavation had to be carried out from above. The Byzantine debris above the tomb contained a great amount of large building stones from a destroyed house, and rubbish from this building was found right down in the tomb chamber. Above the level of the bed-rock, the accumulated earth had a thickness of about 1.50 m. The typical stratification with two separate Byzantine floor levels, observed in the other pits dug in this area of the tomb field, was not clearly traceable in this shaft. After having removed this foreign earth, the following stratigraphical observations were made.

The dromos was filled with *chavara* and *chomnos* of different consistencies, stratified in four layers, giving no certain evidence of secondary burials.



Fig. 192. Enkomi. Tomb 3, dromos.



Fig. 193. Enkomi. Tomb 7, dromos.

The strata in the collapsed Chamber A were the following:

- 1) A fan-shaped layer of *chavara* close to the stonion.
- 2) A burial stratum immediately inside the entrance.
- 3) A layer of loose earth with *chavara*, and large pieces of rock mixed, at the back of the chamber, with silted clay.
- 4) Another layer of finer debris from the roof. It contained also, a building stone from the Byzantine settlement in the S. part of the tomb. This stone has, evidently, sunk through Layer 3.
- 5) A layer of silted clay, containing much ash and carbonized matter, spreading from the entrance along the N. wall of the chamber.
- 6) A thick, silted burial layer resting on the floor.

These stratigraphical observations give valuable hints as to the reconstruction of the history of the tomb. Layer 6 represents the oldest burials of the chamber. Its considerable thickness — up to 0.20 m. — makes it presumable that it contained many different burials, partly accumulated on top of each other.

Layer 5 must be due to a purification of the chamber by fire. The tomb was, apparently, in continuous use, and the cleaning was meant as a preparation for further burials. The extensive collapse of the roof, traceable in Layer 3, was perhaps directly caused by the heat of the purifying fire, which affected the solidity of the limestone rock. The collapse was, however, not definite, and the vault of the roof was weakened, though still standing. Next, the single burial, represented by Layer 2, took place; and this was the last time the tomb was used. The final collapse first came in Byzantine times. The finds belonging to the very

last burial (Layer 2) were only the two pots Nos. 1 and 25. The rest of the finds lay either on the floor, or in the silted Layer 6, and must, therefore, be treated as a single group.

Chamber B was never used for burials. It was only a small ossuary containing a heap of mouldered skeletal remains of, at least, six bodies. A few tomb-gifts were also found. The situations of the six skulls found in the ossuary show, that they have been piled up on top of each other.

BURIALS

The two interesting points of the burial customs, traced in the tomb, have already been mentioned in connection with the stratigraphical observations, i. e., the presence of an ossuary, and the evidence of a purification ceremony.

As regards the original positions of the dead bodies the evidence is not quite satisfactory. None of the skeletons were found exactly *in situ*, because of the water which had intruded into the burial strata, but it seems very probable that the majority of the dead bodies had been deposited in sitting positions, surrounded by their personal burial gifts: at least, there is not a single fact that contradicts the hypothesis.

The following observations uphold it: —

- 1) The main disposition of the skeletal remains around the walls of the tomb, is an indication that the corpses have been seated along the walls, facing the centre of the chamber.
- 2) The frequent presence of both skulls and legs — the former on top of the latter — close to the walls.
- 3) The frequent occurrence of crossed femora, with cubital bones and humeri in their immediate neighbourhood.

An approximation of the total amount of the burials, which have taken place in the chamber, gives a number round about 13 or 15. To this sum should be added the remains of the six skeletons in the ossuary. This considerable number makes it clear, that the tomb has been in use for a long time.

FINDS (GROUPS: PL. LXXIX, 2, 3; TYPES: L. OF PL. II)

Chamber A

1. Levanto-Helladic shallow bowl with base-ring; vertical sides; splaying rim, and handle from rim to body. Encircling lines around rim, body, and base; an encircled spiral inside. Mat paint. Diam. 8.5. — 36.
2. Levanto-Helladic squat stirrup-vase with base-ring. Encircling lines round shoulder, body, and base; concentric circles on the knob, and painted handles. Half the base, spout, and one handle missing. Lustrous paint. Height 11.8. — 81.
3. White Shaved bobbin-shaped bottle with pointed base; neck and handle missing. Height 12.0. — 82.
4. Plain White Wheel-made oval jug with base-ring; concave, splaying neck; stilted rim, and handle from rim to shoulder. Height 22.4. — 81.
5. Levanto-Helladic shallow bowl with base-ring; curved outline; splaying rim, and handle from rim to body. Mat paint. Decoration as No. 1. Diam. 8.1. — 86.
6. Shallow bowl of black steatite with flat, plain rim; round base, and three legs. The legs are decorated with straight lines and encircled dots. One leg missing. Diam. 9.15. — 86.
7. Levanto-Helladic shallow bowl with base-ring; straight rim, and one horizontal handle at rim. Decorated as No. 1. Mat paint. Diam. 10.8. — 92.
8. White Shaved bobbin-shaped bottle with pointed base; narrow, concave neck; slightly pinched mouth, and handle from rim to shoulder. Height 16.7. — 87.
9. Grey steatite bowl, as No. 6, but with legs narrowing downwards. No decoration. Two legs broken. Diam. 15.8. — 82.
10. White Slip II shallow bowl with round base; slightly in-turned rim, and a triangular wish-bone handle below rim. A band of two broad lines, framing two narrower ones, around rim, and similar bands hanging

- vertically from rim to base. Transverse lines on handle. Paint worn. Diam. 16.3. — 89.
11. Plain White Hand-made oval jug with large, flat base; concave neck; stilted rim, and curved, clumsy handle from rim to shoulder. Height 19.6. — 86.
 12. Levanto-Helladic flat, shallow bowl with high, concave stem. Encircling lines around rim, body, and base; concentric circles inside. Mat paint. Diam. 20.3. — 76.
 13. Levanto-Helladic shallow bowl with base-ring, and two horizontal handles at rim. Decorated as No. 12. Mat paint. Diam. 20.0. — 92.
 14. Levanto-Helladic shallow bowl with base-ring; angular outline; almost vertical sides, and a horizontal handle below rim. Encircling lines around rim and base. Diam. 12.3. — 92.
 15. Two circular bronze bracelets. Much corroded. Diam. 5.8. Floor.
 16. Two circular bronze bracelets. Much corroded. Diam. 7.3. Floor.
 17. Circular bronze bracelet. Very much damaged. Floor.
 18. Two spindle-whirls of stone with one flat, and one convex side. Decorated with concentric, incised circles on the convex side. Diam. 2.2; 1.5. Floor.
 19. Seven small blue, and three larger white, beads of paste. Floor.
 20. Fragment of a strip of gold leaf. Length 3.0. Floor.
 21. Plain, roughly circular disc of ivory. Diam. 5.4. Floor.
 22. Plain, roughly circular disc of ivory with profiled edge. Diam. 5.5. Floor.
 23. Roughly circular, thin disc of ivory with an incised frieze of framed, curved lines round the edge, and a hole through the centre. Incomplete. Diam. 8.15. Floor.
 24. Roughly circular disc of ivory, with a hole through the centre. It is decorated with a very complicated and delicate geometric design: a regular pentagon with concave sides, inscribed in a similar figure in the centre, surrounded by a frieze of volute elements, and a border of framed, curved lines. Diam. 8.9. Floor.
 25. White Shaved bottle, as No. 8. Rim chipped. Height 18.4. — 47.
 26. Plain White Wheel-made very shallow bowl with flat base; pinched, raised rim, and a short string-hole projection at rim. Diam. 11.8. — 66.
 27. White Slip II bowl, as No. 10, but with all the lines of equal thickness. Diam. 13.0. — 89.
 28. Levanto-Helladic shallow bowl with base-ring, and straight rim. No handle. Decorated as No. 12. Mat paint. Diam. 8.0. — 86.
 29. Levanto-Helladic shallow bowl with base-ring; curved outline; splaying rim, and handle from rim to body. Decorated as No. 1. Mat paint. Diam. 11.1. Floor.
 30. Base-ring II globular jug with wide, convex neck, and handle from rim to shoulder. Rim and part of neck missing. Height 9.0. Floor.
 31. Plain White Wheel-made jug, as No. 4. Height 14.5. Floor.
 32. White Painted Wheel-made oval jug, with flat base; concave neck; splaying rim; handle from rim to shoulder, and a narrow, tubular spout opposite the handle. Encircling lines around rim and neck, and vertical lines from neck to base. Height 12.5. Floor.
 33. White Painted Wheel-made jug, as No. 32. Neck and handle missing. Height 8.5. Floor.
 34. Levanto-Helladic stirrup vase, as No. 2. Encircling lines around shoulder, body, and base; concentric circles on the knob, and a shoulder ornament of concentric quarter-circles. Dark, lustrous paint. Height 11.6. Floor.
 35. Levanto-Helladic stirrup-vase with base-ring, and globular body. Encircling lines around shoulder, body, and base; concentric circles on the knob, and a shoulder decoration of repeated ornaments, consisting of two parallel, angular lines; a hooked, dotted line forming an irregular lozenge, and a curved line inside the ornament. Red, lustrous paint. Height 11.5. — 94.
 36. Plain White Wheel-made jug, as No. 4, but with flat base. Rim chipped. Height 16.7. — 92.
 37. White Painted Wheel-made jug, as No. 32. Height 10.2. — 98.
 38. Base-ring II oval jug with cylindrical neck; a ridge between neck and shoulder; splaying, sharp rim, and flat handle from rim to shoulder. Height 19.4. Floor.
 39. Red Slip Wheel-made almost hemispherical bowl with round base, and plain rim. No handle. Diam. 13.6. Floor.
 40. Base-ring II shallow bowl with concave, angular outline; raised, profiled rim, and a curved, knobbed wish-bone handle at rim. Incomplete. Diam. 17.5. — 91.
 41. Base-ring II bowl, as No. 40. Diam. 11.3. — 92.
 42. Levanto-Helladic bowl, as No. 28, but with two string-holes. Mat paint. Diam. 11.0. — 89.
 43. Plain White Hand-made jug, as No. 11. Height 18.0. — 85.
 44. Plain White Wheel-made jug, as No. 36. Height 17.9. Floor.
 45. Plain White Wheel-made bowl, as No. 26, but with an oblong string-hole projection at rim. Diam. 11.4. — 82.
 46. Levanto-Helladic bowl, as No. 7; decorated as No. 12. Mat paint. Diam. 10.9. — 85.
 47. Levanto-Helladic oval jug with base-ring; concave neck; splaying rim, and handle from rim to shoulder. Encircling lines around rim, neck, belly, and base; painted handle. Mat paint. Height 18.7. — 85.
 48. Levanto-Helladic flat bowl with base-ring; flattened rim; handle from rim to body, and a long, open spout, opposite the handle. Encircling lines around rim, body, base, handle, and spout; inside the bottom, concentric circles framing a continuous, plaited band with short, wavy lines on the plait elements. Red, lustrous paint. Diam. 23.9. — 72.
 49. Levanto-Helladic cup-shaped bowl with small base-ring; splaying, concave sides; flaring rim, and handle from rim to body. Decorated as No. 1. Mat paint. Diam. 9.7. — 79.

50. Plain White Wheel-made bowl, as No. 39. Diam. 9.5. — 79.
51. Plain White Wheel-made jug, as No. 36. Diam. 16.9. — 79.
52. Levanto-Helladic deep bowl with base-ring; curved sides; splaying rim, and two horizontal handles on body. Painted red inside; encircling lines around rim, belly, base, and handles. A plaited band, similar to that of No. 48, between the handles. Red, lustrous paint. Diam. 19.2. — 89.
53. Plain White Hand-made shallow bowl with round base; straight rim, and a simplified wish-bone handle below rim. Diam. 12.6. — 67.
54. Plain White Hand-made shallow bowl with round base; flat, raised rim, suggesting a metal prototype, and a string-hole projection at rim. Diam. 17.7. — 73.
55. Levanto-Helladic jug, as No. 47. Incomplete. Mat paint. Height 20.2. Floor.
56. Plain White Wheel-made oval, deep crater with tapering body; high, conical foot; wide, tapering, short neck; flat rim, and two vertical, indented handles from rim to shoulder. Height 28.4. Floor.
57. Plain White Wheel-made shallow bowl with rounded sides; flat base; straight rim, and a more than semi-circular horizontal handle at rim. Diam. 12.5. Found in No. 56.
58. Levanto-Helladic bowl, as No. 14; decorated as No. 1. Mat paint. Diam. 13.3. Found in No. 56.
59. Plain White Wheel-made jug, as No. 4. Height 17.6. Found in No. 56.
60. Plain White Wheel-made bowl, as No. 50. Diam. 8.6. Floor.
61. Plain White Wheel-made bowl, as No. 50. Diam. 10.6.
62. White Slip II bowl, as No. 10, but with bands of ladder-pattern, alternating with shorter, dotted lines instead of parallel lines. Diam. 18.0. Floor.
63. Levanto-Helladic bowl, as No. 7. Mat paint. Diam. 11.7. Floor.
64. Levanto-Helladic pear-shaped stirrup-vase with splaying base-ring. Decorated as No. 35. Lustrous paint. Height 15.2. Floor.
65. Levanto-Helladic stirrup-vase, as No. 2; decorated as No. 34, but with a wavy line around belly. Lustrous paint. Height 11.2. Floor.
66. Plain White Wheel-made jug, as No. 4, but with pinched mouth. Rim chipped. Height 16.3. In No. 70.
67. Monochrome shallow bowl with round base; splaying sides, and straight rim. No handle. Diam. 7.0. Floor.
68. Monochrome shallow bowl, with flat base; curved sides; raised, contracted rim, and horizontal handle below rim. Handle missing. Diam. 10.1. Floor.
69. Plain White Wheel-made jug, as No. 36. Height 17.0. Floor.
70. Base-ring II bowl, as No. 41. Diam. 16.2. Floor.
71. Plain White Hand-made bowl, as No. 54. Diam. 17.2. Floor.
72. Bowl of grey steatite with pestle of limestone. Bowl as No. 6, but with free, projecting feet decorated with framed, parallel, wavy lines. Diam. 13.7. Floor.
73. Levanto-Helladic flat bowl with base-ring; stilted rim, and two horizontal handles on rim. Encircling lines around rim, body, base, and handles; concentric circles inside, framing a band of lozenges with concave sides, and semicircles with a central dot in the corners. Lustrous paint. Diam. 19.2. Floor.
74. Plain White Hand-made jug, as No. 11, but with more sack-shaped body. Height 18.7. — 79.
75. White Painted Wheel-made jug, as No. 32. Rim chipped. Height 9.8. — 82.
76. Plain White Wheel-made bowl, as No. 39, but with straight rim and no string-holes. Rim chipped. Diam. 9.8. — 76.
77. Plain White Wheel-made jug, as No. 11, but with wider neck, and handle from below rim to shoulder. A graphical sign on handle and rim. Height 20.2. — 76.
78. Hand-made Bucchero oval jug with wide shoulder; base-ring; a ridge between neck and shoulder; concave neck; sharp, splaying rim, and a curved, flat handle from rim to shoulder. Fluted body. Height 15.8. Floor.
79. Plain White Wheel-made jug, as No. 4. Handle, and piece of rim missing. Height 16.1. — 88.
80. Levanto-Helladic stirrup-vase, as No. 35, but with a wavy line around belly. Lustrous paint. Height 12.0. Floor.
81. Plain White Wheel-made jug, as No. 36. Height 16.1. — 72.
82. Plain White Wheel-made bowl, as No. 49. Diam. 9.6. — 76.
83. White Shaved bottle, as No. 8. Height 16.7. Floor.
84. Plain White Hand-made jug, as No. 11. Height 20.0. — 79.
85. Levanto-Helladic bowl, as No. 5. Mat paint. Diam. 9.6. — 86.
86. Plain White Wheel-made jug, as No. 4. Rim and handle missing. Height 13.2. Floor.
87. Plain White Wheel-made crater, as No. 56, but with lower foot. One handle missing. Height 21.3. — 88.
88. Plain White Wheel-made jug, as No. 36. Neck and handle missing. Height 6.5. — 73.
89. Plain White Hand-made shallow bowl with flattened base; flat, raised rim, and a string-hole handle at rim. Diam. 12.2. — 80.
90. White Painted Wheel-made jug, as No. 32, but with painted handle and spout. Height 10.8. Floor.
91. Bobbin-shaped glass bottle with cylindrical neck; flat rim; pointed base, and two vertical handles on shoulder. The material is white glass paste, incrustured with wavy, yellow lines. Broken. Height c. 10.5. Floor.
92. Levanto-Helladic bowl, as No. 13. Mat paint. Diam. 14.7. Floor.
93. Plain White Hand-made bowl, as No. 54. Diam. 10.7. Floor.
94. Plain White Wheel-made bowl, as No. 45, but with short string-hole projection. Diam. 18.7. Floor.

- 95. Levanto-Helladic bowl, as No. 42. Mat paint. Diam. 10.5. — 76.
- 96. Pestle of grey steatite, belonging to bowl No. 9; in the shape of a truncated cone with convex base. Length 4.9. Floor.
- 97. Plain White Wheel-made bowl, as No. 60. Diam. 9.2. Floor.
- 98. Spindle-whirl of stone, as No. 18; a framed frieze of concentric circles on the convex side. Diam. 3.4. Floor.
- 99. One plain white, one fluted white, and one fluted blue paste bead. Floor.
- 100. Plain, circular silver ring. Diam. 2.0. Floor.
- 101. Pin of ivory with one flat, and one pointed end. Small, incised lines at each end. Length 23.2. Floor.
- 102. Roughly circular disc of ivory with a hole through the centre, and a frieze of framed, curved lines around edge. Diam. 5.3. Floor.
- 103. Roughly circular disc of ivory with a hole through centre; decorated similarly to No. 24. In the centre is a lozenge with concave sides and small semicircles in the corners, all surrounded with a framed frieze of volute ornaments. Diam. 6.4. Floor.
- 104. Oblong, plain strip of gold leaf with rounded ends and a hole in each end. Worn. Length 9.7. — 86.
- 105. Strip of gold leaf, as No. 104. Worn. Length 10.5. Floor.

C h a m b e r B

- 1. Bronze bracelet with overlapping ends. Diam. 5.2.
- 2. Levanto-Helladic bowl, as above No. 49. Diam. 10.3.

A summary of the Object Register gives the following diagram:

		P o t t e r y											Bronze		Silver	Gold	Faience	Glass	Stone			Ivory						
		Hand-made					W h e e l - m a d e						Bracelets	Ring	Strips	Beads	Bottle	Spindle whirls	Pestles	Bowls	Pin	Discs						
		Base-ring II	Monochrome	Wh. Shaved	Bucchero	Pl. Wh.	Wh. Sl. II	Pl. Wh.	Red Sl.	Wh. P.	Levanto-Helladic																	
Chamber A		30	67	3	78	11.	43	10	4	26.	31.	36	39	32	2.	5.	7.	12	15	100	20	19	91	18	72	6	101	21
		38	68	8		53.	54	27	44.	45.	50.	51	33	13	14.	28.	29			104	99		18	96	9		22	
		40		83		71.	74	62	56.	57.	59.	60	37	34.	35.	42.	46			105	99		98		72		23	
		41				84.	89		61.	66.	69.	76	75	47.	48.	49.	52										24	
Early burials		70				93			77.	79.	81.	82	90	55.	58.	63.	64										102	
									86.	87.	88.	94		65.	73.	80.	85										103	
									97					92.	95													
		-5	-2	-3	-1	-9	-3																					
Chamber A																												
Late burial			25																									
Chamber B																												

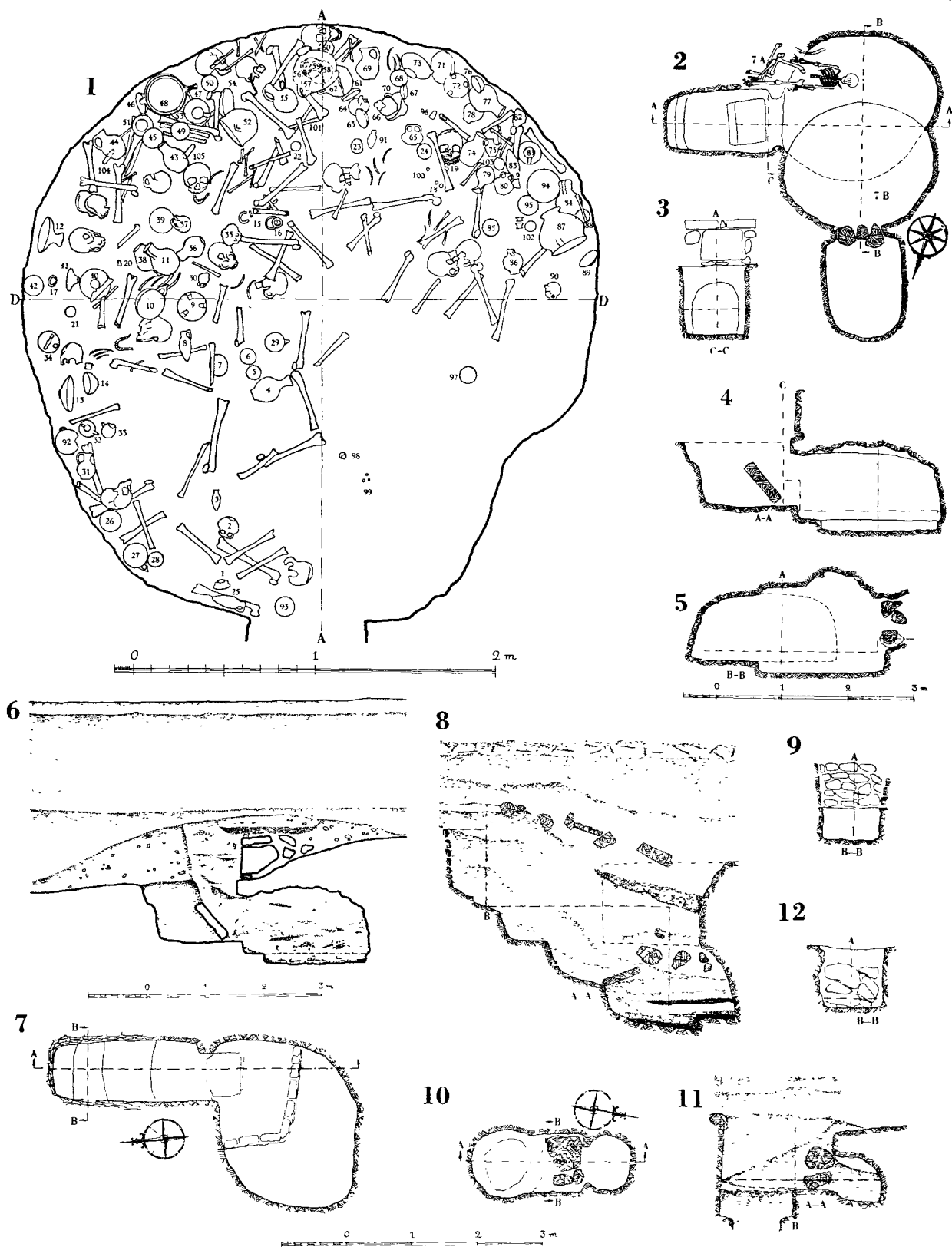

Fig. 194. Enkomi. Tomb 6, Finds *in situ* (1). Tomb 7, Plan (2); Sections C-C, A-A, B-B (3, 4, 5); Reconstructed section (6). Tomb 8, Plan (7); Sections A-A, B-B (8, 9). Tomb 9, Plan (10); Sections A-A, B-B (11, 12).

TOMB 7 (Figs. 193; 194: 2—6)

	SIZE			
	Length	Width	Depth	Height
Dromos	1.65	0.97	1.05	—
Stomion	0.18	0.70	—	0.79
Chamber	2.30	c. 2.20	—	1.02
Tomb 7 A	c. 1.80	c. 1.20	—	—
Tomb 7 B	1.87	2.24	—	1.15

SHAPE

What is here described as Tomb 7 is more properly a complex of three tombs. They are here treated under one heading merely because of their local conditions. The evidence for their relative chronology also favours their being treated in close connection with one another.

Tomb 7 A is a shallow, rectangular shaft dug in the earth on top of Tomb 7. No stones mark its limits.

Tomb 7 itself is of the usual, rock-cut type. The dromos is oblong with perpendicular long sides; rounded corners; horizontal floor, and a narrow step in the back wall. Above the door, the façade of the dromos is built of dressed stones to a height of about 0.70 m. The heavy door slab of calcareous stone was found over-turned. The stomion is short, and leads with a low step down to the horizontal floor of the roughly circular chamber.

The chamber has, however, intersected another tomb (Tomb 7 B) of much the same type. That Tomb 7 B is the older of the two, is shown conclusively by the lower level of its floor. The dromos of this tomb was never excavated, but its intact door-packing, consisting of several small stones, could be studied from the chamber.

The structural evidence, thus, is satisfactory for establishing a relative chronology between the three tombs. The sequence is: Tomb 7 B; Tomb 7; Tomb 7 A.

STRATIFICATION

Turning to the stratigraphical conditions of this complex of tombs, their development and destruction become more evident. As it could be clearly observed at the beginning of the excavations, that the two tombs were entirely robbed, detailed and exact sections of the filling were not drawn, but the observations were summed up in a sketch, which in all essential parts renders a true picture of the conditions (Fig. 194: 6).

Below the earth of the modern field followed a layer of Byzantine debris, about 1.70 m. thick. Thereafter came a stratum of heterogeneous composition, apparently levelled in Byzantine time. It consisted principally of clay and rock material, mixed with some culture earth and ash. The next layer was a convex stratum of *chavara* and small stones. It held some Late Cypriote III potsherds and is, thereby, dated. At the apex of this curved

layer just above the stomion of Tomb 7 the shallow shaft, called Tomb 7 A, was found, and from this level a deep pit had been dug down to the entrance of Tomb 7. It was filled with dark earth, containing many potsherds of the same type, and even of the same vases, as those found later in the tomb. This layer continued into the chamber, where it was more freely mixed with burial earth, skeletal remains, and fragmentary tomb-gifts. From this pit, Tombs 7 and 7 B, between which the communication was free, have consequently been sacked. A *terminus ante quem* for the robbery is given by the intact Tomb 7 A, and it seems presumable, to connect it with this burial. The situation of Tomb 7 must have been known at that time, as it was defined by the heap of earth and stone, traceable in the above-mentioned curved layer of *chavara* and small stones. That is to say, that this tomb was surmounted by a low tumulus. The top of the tumulus was chosen as burial place at the end of the Bronze Age, and before the burial took place, the tumulus was dug through and Tomb 7 sacked. The considerable number of fragments of gold objects, which were left by the robbers, seem to argue, that the robbery was made in great haste.

Before the Byzantine epoch the tumulus had been covered over with extraneous earth.

BURIALS

Because of the bad state of preservation of the few skeletal remains in Tombs 7 and 7 B, and their being disturbed by the plundering of the tomb, no conclusions could be drawn regarding the burial customs, in use in the chambers. In the shallow shaft (T. 7 A) two well preserved skeletons were found, one partly on top of the other. The lower lay in a slightly contracted, prostrate position with crossed, bent legs. The arms were missing. The other one was lying in a dorsal, outstretched position with the arms along the sides and the right knee slightly bent. Both skeletons were surrounded by some burial gifts.

FINDS (GROUPS: PL. LXXXI, 7, 8; TYPES: L. OF PL. II)

T o m b 7 A

1. Plain White Wheel-made oval jug with flat base; ridges below neck; thick, tapering neck; thick, stilted rim, and handle from rim to shoulder. On the handle some graphical signs are incised. Height 52.0.
2. Plain White Wheel-made jug, as No. 1. Rim missing. Height 31.3.
3. Plain White Wheel-made jug, as No. 1, but with pinched mouth, and handle from rim to shoulder. Handle missing. Height 25.4.
4. Levanto-Helladic shallow bowl with base-ring, and two pinched, horizontal handles on rim. Encircling lines outside and inside. Mat, red paint. Diam. 15.7.
5. Fragments of a shallow bronze bowl with round base and stilted rim.
6. Cylinder of steatite. The engraving represents a seated figure holding a twig in his hand; the chair is small and without back, and the position of the figure is more leaning than sitting. In front of the figure are two small, converging lines probably representing a bucranium, and in front of these, stands a pillar. At the top of the pillar is a half-moon, enclosing a dot, and above the half-moon another conventionalized bucranium. Behind the seated figure stands a male figure dressed in long gown, and holding an object in his left hand. Behind the standing figure are three encircled dots, arranged in a row from edge to edge. The lowermost of these circles is provided with some scratchings which might be interpreted as a graphical sign. The engraving is rough, and the surface rather worn. Length 2.3.

The Object Register of Tomb 7 A is summed up in the diagram below:

P o t t e r y		Bronze	Glyptics
Pl. Wh.	Lev.-Hell.	Bowl	Cylinder
1. 2. 3	4	5	6
-3	-1	-1	-1

CHRONOLOGY

The sherds found in dromos and chamber of Tomb 7 consisted of Levanto-Helladic Ware, frequently mixed with genuine Cypriote wares, very much resembling the contents of Tomb 3. This dates the tomb to the middle of Late Cypriote II. As stated above, Tomb 7 B is earlier, but as the contents of the two chambers have been mixed by tomb-robbers, it is impossible to say how much earlier it is. At all events the connected chambers did not contain any Middle Cypriote pottery, so that the difference in date between the two cannot have been very great.

The Plain White vases of Tomb 7 A are typical of the Late Cypriote III period. Consequently, a considerable lapse of time has passed between the burials of the chambers and the earth burial in the tumulus above the original tomb.

TOMB 8 (Figs. 194:8—9; 195:1)

SIZE

	Length	Width	Depth	Height
Dromos	2.28	0.94	c. 1.85	—
Stomion	0.25	0.72	—	c. 0.70
Chamber	2.08	2.46	—	c. 1.25

SHAPE

The dromos of this tomb differs in shape from the other tombs found on the burial ground. It is a narrow, deep corridor which, by means of three large steps, leads down to the stomion of the tomb. Around the edge of the dromos was built a wall of roughly dressed stones to a height of about 0.65 m. The tomb was found in the periphery of the area excavated, where the rock is of a very soft and argillaceous consistency — so-called *chonnos* — and that seems to give an explanation of the peculiarities of the dromos shape. It was cut to a great depth in order to reach safer ground, and this circumstance made the three steps necessary for facilitating the entrance. To avoid the collapse of the dromos, its walls were strengthened with the masonry.

The chamber is an irregular oval, and the entrance is asymmetrically placed at the E. end of the N. long side. The chamber consists of a small, rectangular area just inside the stomion, and two extensive, shallow recesses along the S. and W. walls. The edges of these niches are lined with flat stones.

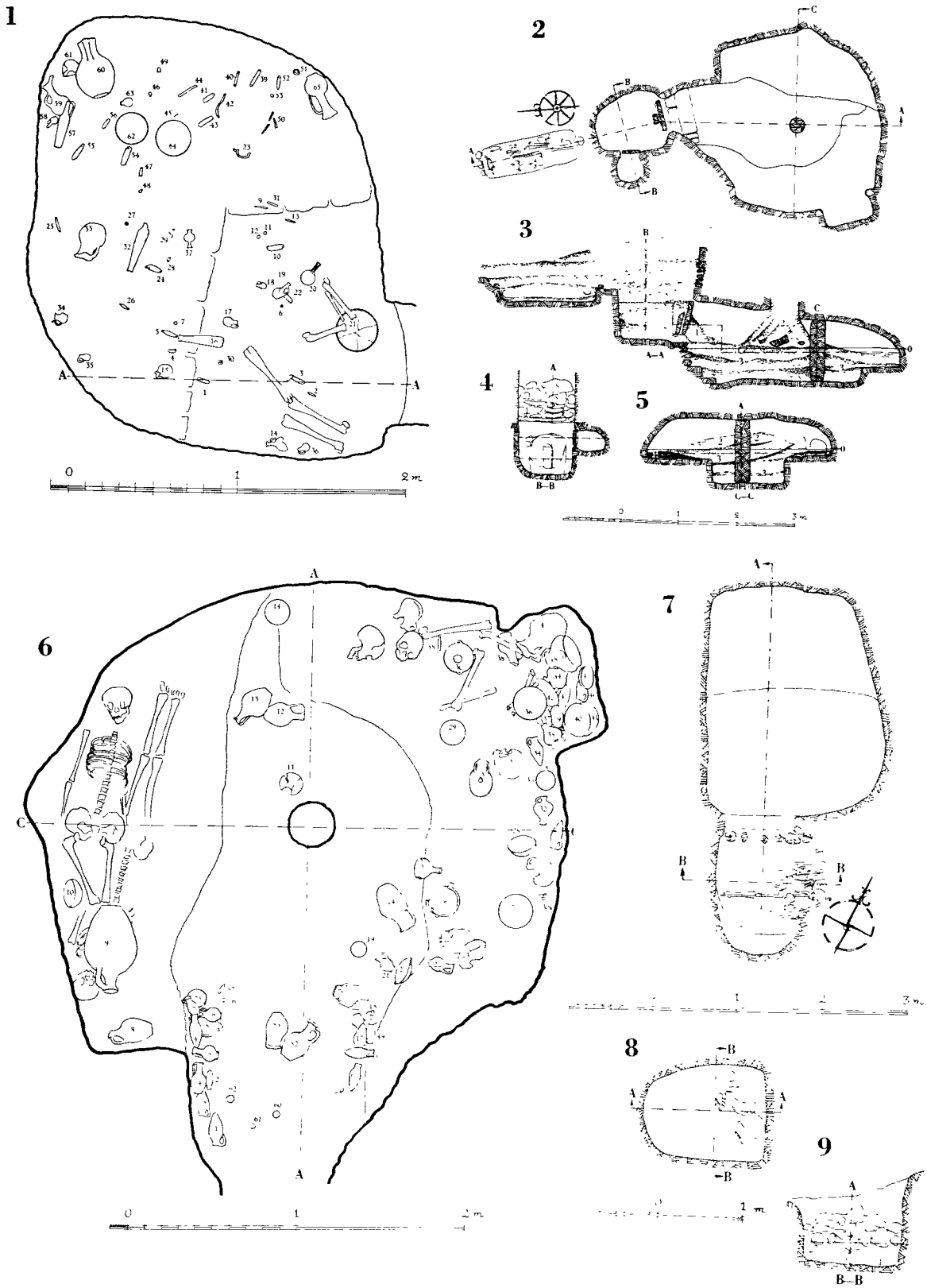

Fig. 195. Enkomi. Tomb 8, Finds *in situ* (1). Tomb 10, Plan (2); Sections A-A, B-B, C-C (3, 4, 5); Finds *in situ* (6). Tomb 11, Plans (7, 8); Section B-B (9).

STRATIFICATION

The soft rock had not resisted the heavy pressure of the overlying masses of earth, and the tomb was fallen in. The long shaft which had to be dug from above to clear the area, revealed an interesting stratification. The Byzantine debris was here about 0.75 m. deep, and rested on a horizontal floor of hard-packed *chavara* and small stones. This floor is abruptly broken off, and remains of it were found in the obliquely stratified debris above the chamber. The destruction had, apparently, taken place when the vaulted roof of the chamber, which supported this part of the Byzantine building, collapsed. At the bottom of the architectural debris was a definite layer of ash and carbonized matter. Below the Byzantine layer was a thick stratum of almost sterile *chonnos*, extending over both dromos and chamber. Its provenience is clear: it consists partly of the upper layer of the original dromos-filling, partly of the pulverized rock above the fallen-in chamber. In the dromos were two other layers of similar material, but of different compactness, which seems to prove that the dromos has, at least once, been reopened for secondary burials. Large blocks of rock follow in the next layer above the chamber, emanating from its final collapse. The rest of the stratification of the chamber showed two burial layers, separated from each other by a layer of horizontally stratified *chonnos* matter, the earlier spread over the floor and comprising Finds Nos. 6-7, 10-22, 24-37, 39-48, 50-59, and 61-63; the later on the higher level with the rest of the finds, except for Nos. 8 and 38 which were found in the sieves.

BURIALS

The skeletal remains of the earlier burial period were completely mouldered and a thin layer of decomposed, organic matter covered the floor and the niches. There may have been 3-4 bodies deposited in the chamber. To the upper layer belonged a few bones apparently *in situ*. Two femora and a tibia indicate that one body has been placed sitting with its back against the wall close to the right of the entrance. On the opposite side of the door was another femur and tibia. Their positions, however, do not allow of any conclusions regarding the burial custom.

FINDS (GROUPS: PL. LXXX; TYPES: L. OF PL. II)

- | | |
|---|---|
| <ol style="list-style-type: none"> 1. Strip of gold leaf with rounded ends, pierced by holes. Irregular, wavy outline. Length 7.8. 2nd B.* 2. Miniature strip of gold leaf, as No. 1. Length 5.7. 2nd B. 3. Strip of gold leaf with convex sides and straight end, pierced by holes. Length 14.8. 2nd B. 4. Miniature strip of gold leaf, as No. 1. Length 6.8. 2nd B. 5. Miniature strip of gold leaf, as No. 1. Embossed dots around the edges of the long sides. Length 10.75. 2nd B. 6. Spherical bead of transparent amethyst. Diam. 0.9. 1st B. 7. Oval gold earring with a pendant of filigree-dots forming an ox's head. Length 1.75. Floor. | <ol style="list-style-type: none"> 8. Oval silver earring with a small pendant. Length 1.7. Found in the sieves. 9. Gold pin with an eyelet half-way down the shaft, and scratchings on upper part of pin. Length 7.8. 2nd B. 10. Strip of gold leaf with convex sides, and tapered ends with holes. Length 10.7. 1st B. 11. Oval earring of white gold; pair to No. 48. Pendant missing. Diam. 1.4. 1st B. 12. Oval gold earring with a pendant of four balls, suggesting grapes; pair to No. 46. Length 1.6. 1st B. 13. Straight silver pin with a loop-head. The silver contains bronze. Length 5.6. 1st B. 14. White Painted V globular jug with tall, tapering neck; splaying rim; raised, pinched mouth, and handle from |
|---|---|

* 1st B. and 2nd B. refer to the earlier and the later burial layer.

- neck to shoulder. Encircling bands around neck and shoulder; rest of paint obliterated. Base missing. Height 13.5. 1st B.
15. Black Slip II oval jug with flattened base, and wide, cylindrical neck. Rim and handle missing. Paint worn. Height 14.6. 1st B.
 16. Red Lustrous Wheel-made tall, narrow bottle with base-ring, and slanting shoulder. Neck and handle missing. Height 26.0. 1st B.
 17. Black Slip II jug, as No. 15, but with slightly splaying rim, and a raised handle from rim to shoulder. Height 8.5. 1st B.
 18. Black Slip II jug, as No. 17. Slip almost obliterated. Height 6.6. 1st B.
 19. Black Slip II globular jug with flat base; tall, tapering neck; funnel-rim, and handle from neck to shoulder. Horizontal relief-decoration on neck and shoulder, and vertical front ornaments from neck to base. Height 12.5. 1st B.
 20. Monochrome flat, lentoid bottle with tall, tapering neck; splaying rim, and handle from neck to shoulder. Height 15.4. 1st B.
 21. Plain White Wheel-made wide, shallow bowl with base-ring, and in-turned, thickening rim. Diam. 25.2. 1st B.
 22. Fragments of two bronze daggers. 1st B.
 23. Long, narrow strip of gold leaf with rounded ends, pierced by holes. Length 14.4. 2nd B.
 24. Strip of gold leaf, as No. 23. Length 9.5. 1st B.
 25. Strip of gold leaf, as No. 23. Length 8.95. 1st B.
 26. Strip of gold leaf, as No. 23, but with convex sides. Length 6.35. 1st B.
 27. Twisted, circular earring of gold. Diam. 1.6. 1st B.
 28. Flat, spherical gold bead with fluted surface, and small spherical projections at the ends. Diam. 1.25. 1st B.
 29. Fragment of a silver pin which has been covered by thin, ornamented gold leaf. Incomplete; broken into two pieces. Length 3.8. 1st B.
 30. Plain, circular bronze ring. Badly corroded. Diam. 2.8. 1st B.
 31. Fragments of straight strip of bronze. Length 6.25. 1st B.
 32. Red Lustrous Wheel-made bottle, as No. 16. Neck and handle missing. Height 29.4. 1st B.
 33. White Painted Wheel-made globular jug with flat base; concave neck; splaying rim; pinched mouth, and handle from rim to shoulder. A horizontal line between neck and shoulder; vertical lines from neck to base, and long, arched lines from base to belly. Height 26.2. 1st B.
 34. Base-ring I squat jug with curved base-ring; wide, tapering neck; splaying rim; handle from rim to body, and a large, knobbed projection on rim at top of handle. Horizontal relief-ornaments below rim. Height 7.5. 1st B.
 35. Plain White Hand-made globular jug with round base; wide, tapering neck; slightly splaying rim, and a raised handle from rim to shoulder. Height 6.8. 1st B.
 36. Plain White Hand-made jug, as No. 35. Height 7.2. 1st B.
 37. Chalice-shaped vase of faience with high stem, and splaying foot; spherical body; cylindrical neck, and flat rim. Surface much worn; rim missing, foot chipped. Yellowish white colour. Height 10.9. 1st B.
 38. Two biconical cornelian beads with holes through the longitudinal axis. Length 1.5. Found in the sieves.
 39. Strip of gold leaf, as No. 23, but with convex sides and straight ends. Length 10.65. 1st B.
 40. Strip of gold leaf, as No. 39. Length 9.0. 1st B.
 41. Short, broad strip of gold leaf with rounded ends, and irregular, wavy sides. Length 7.65. 1st B.
 42. Long, narrow strip of gold leaf with rounded ends, and irregular, wavy sides. Length 16.65. 1st B.
 43. Strip of gold leaf with concave sides and straight ends. Length 9.4. 1st B.
 44. Strip of gold leaf with straight sides and rounded corners. Embossed dots around the edges. Length 12.8. 1st B.
 45. Plain, miniature gold pin with an eyelet half-way down the shaft. Length 3.65. 1st B.
 46. Oval earring of white gold with a pendant of four balls, suggesting grapes. Pair to No. 12. Length 1.6. 1st B.
 47. Miniature strip of gold leaf. Length 4.6. 1st B.
 48. Oval earring, as No. 46. Pair to No. 11. Length 1.9. 1st B.
 49. Flat, square gold bead composed of four tubes, plain on one side, and on the other covered with small triangles in filigree-work. Length 1.4. 2nd B.
 50. Three hooked silver fragments of pins, all of them containing bronze. Badly damaged. 1st B.
 51. Circular bronze ring with overlapping ends. Badly corroded. Diam. 4.5. 1st B.
 52. Short, broad bronze knife with two rivet holes through shoulders, and short, flat, tapering tang. Broken. Length 7.8. 1st B.
 53. Spherical bead of blue paste. Diam. 0.6. 1st B.
 54. Strip of gold leaf, as No. 5. Length 10.9. 1st B.
 55. Strip of gold leaf with convex sides and straight ends. Length 11.55. 1st B.
 56. Strip of gold leaf with curved, convex sides and rounded ends. Length 6.55. 1st B.
 57. Red Lustrous Wheel-made bottle, as No. 16. Base and rim missing. Height 27.3. Floor.
 58. Base-ring I squat jug with tall, tapering neck; wide funnel-rim, and handle from neck to shoulder. Incised herring-bone pattern on handle, and incised relief-ornaments on shoulder, and around neck. Rim missing. Height 7.8. Floor.
 59. Base-ring I jug with cylindrical neck; splaying rim; pinched spout, and handle from neck to shoulder. Horizontal and spiral relief-ornaments around neck and shoulder. Height 22.6. Floor.
 60. White Painted Wheel-made oval jug with flat base; a ridge between neck and shoulder; cylindrical neck; splaying rim; pinched mouth, and handle from rim to shoulder. A horizontal line between neck and shoulder, and three groups of vertical lines from neck to base. A similar group below handle. Rim chipped. Height 34.3. 2nd B.

61. Plain White Hand-made flat, open lamp with round base; rim thickening inwards, and pinched, pointed nozzle. Diam. 12.1. 1st B.
62. Plain White Wheel-made bowl, as No. 21, but with plain rim, pierced by two string-holes. Diam. 19.3. Floor.
63. Plain White Hand-made jug, as No. 35. Handle missing. Height 7.1. Floor.
64. Plain White Wheel-made conical bowl with base-ring, and in-bent, thickening rim. Rim chipped. Diam. 21.4. 2nd B.
65. Base-ring II jug with tall neck; flaring rim, and handle from neck to shoulder. Relief-ornaments around neck, and as front ornament. Rim chipped. Height 27.0. 2nd B.

A summary of the Object Register and a distribution of the finds between the two burial periods present the following diagram:

	P o t t e r y							Bronze	Silver	G o l d	Faience	Semi-precious stone												
	H a n d - m a d e					Wheel-made						Daggers & Knife	Rings	Strip	Pins	Earring	Pins	Earrings	Strips	Beads	Bead	Vase	Amethyst	Cornelian
	Bl. Sl. II	Bl. Sl. III	Base-ring I	Base-ring II	Monochrome	Pl. Wh.	Wh. P. V																	
1st burial period	15 17 18	19	34 58 59		20 35 36 61 63	14	21 62	16 32 57	33	22 22 52	30 51	31	13 29 50 50 50		45	7 11 12 27 46 48	10, 24 25, 26 39, 40 41, 42 43, 44 47, 54 55, 56	28	53	37	6			
2nd burial period				65			64		60						9		1, 2, 3 4, 5, 23 -6	49						
Found in the sieves													8 -1									38, 38 -2		

CHRONOLOGY

That the tomb is one of the earlier in the necropolis is shown by the absence of Levanto-Helladic pottery. Among the burial gifts of the first period are five pots, typical of the Middle Cypriote III Period (Nos. 14, 15, 17, 18, 19) and four other pots of early type (Nos. 35, 36, 61, 63). This fact, combined with the presence of Base-ring I Ware, dates the burial group to the beginning of Late Cypriote I.

In the second burial group, the Middle Cypriote wares are missing but still there are no pots or sherds of Levanto-Helladic Ware. The group is thus assigned to the end of Late Cypriote I, principally by the presence of the Base-ring II jug No. 65.

TOMB 9 (Fig. 194: 10—12)

	SIZE	Length	Width	Depth	Height
Dromos	1.65	0.90	0.95	—
Stomion	0.12	0.52	—	0.54
Chamber	0.62	0.83	—	0.68

SHAPE

The dromos of the tomb is defaced, as its S. part has been used in Byzantine times as the starting point for a circular well. The section towards the entrance of the chamber was intact, and of the usual type. The door-packing consisted of several large blocks which, apparently, were *in situ*. The chamber was of miniature size, and had never been used for burial purpose.

STRATIFICATION

The Byzantine debris went right down to the floor of the dromos and the door-packing had been used as steps down to the edge of the well. From the surface of the earth a pit had been dug to a depth of about 1.50 m., evidently the trial-pit of illicit diggers. The Byzantine stratification does not offer anything of great interest.

TOMB 10 (Figs. 195: 2—6; 196; 197)

SIZE

	Length	Width	Depth	Height
Dromos	1.31	1.07	0.95	—
Stomion	0.48	0.90	—	0.75
Chamber	3.15	3.19	—	1.24
Dromos Cupboard	0.53	0.46	—	0.34
Tomb 10 A	1.65	0.60	0.21	—

SHAPE

The dromos is a small, oval shaft with almost perpendicular sides, and flat floor. On the edge of the front side of the dromos, a wall is built of irregular, but roughly dressed stones, an arrangement similar to that found in Tomb 7 (see p. 498). A small dromos cupboard opens from the right side. It is of the usual sack-shaped type, and was closed by a circular, flat stone. The door-packing of the chamber was not founded on the floor, but rested on the bottom layer. It consisted of a flat slab, surmounted by some smaller stones, and strengthened by an oblong, worked stone, propped against the main slab. The packing was not broad enough to cover the whole door.

The stomion does not continue in the longitudinal axis of the dromos, but turns slightly to the right. It leads down to the chamber by means of a built staircase of four steps, the building material of which are stones of the same type as those used in the wall round the front edge of the dromos.

The shape of the chamber is very irregular. The central area is sunk to a lower level than the rest of the chamber, and thus a broad ledge runs round the walls. In the centre of the chamber stands a cylindrical pillar of sandstone, supporting the roof, a unique feature in the construction of the tomb. Near the back wall, the ledge is cut through by a narrow gap,



Fig. 196. Enkomi. Tomb 10, dromos.



Fig. 197. Enkomi. Tomb 10. Interior view with section remaining, and finds *in situ*.

and near the right wall a rectangular niche was found on the level of the ledge. The roof was well preserved and formed a flat vault, culminating just inside the stomion.

Behind the dromos was found a shallow, rectangular shaft with rounded corners. It is called Tomb 10 A. It seems to be contemporary with the main tomb as it was cut out of the rock with the same sort of tool, a narrow chisel with slightly convex edge, which had left clear traces in the walls of both tombs.

STRATIFICATION

The Byzantine layer above the tomb was rather thin. It consisted only of a stratum of mixed debris, about 0.50 m. thick, containing a small amount of fragmentary tiles, and some building stones. Immediately below the Byzantine layer lay several strata of Late Cypriote date. The tomb has, apparently, been covered by a low mound of earth (cf. T. 7). Its upper edge could be traced as a curved layer of earth and small stones, reaching its apex above the stomion of the tomb. From this level a shaft had been dug down to the entrance of the tomb, clearing out the whole dromos except for the bottom stratum. The door-packing had been removed and the tomb entered. A secondary burial had taken place, and when the door stones were replaced they were founded on the remaining layer of the original dromos-filling. The shaft had again been filled, and the filling matter was stratified in four slightly oblique layers of similar consistency, i. e., *chavara* and *chonnos*, containing some potsherds of Late Cypriote date.

This pit has not touched the shaft-tomb 10 A, which held a burial layer with finds and skeletal remains, covered by a hard-packed stratum of clayey earth and *chavara* up to the edge of the shaft. Above the shaft were two layers of sandy earth, mixed with gravels and

small stones, and containing rocky material and ordinary field earth. The uppermost of these layers marks the surface at the time of the burial. Some accumulated earth separated it from the Byzantine strata, which in this section, were mixed with several large sandstone blocks belonging to a destroyed building. These conditions give the final proof that the shaft-tomb is older than the secondary burial in the chamber.

In the chamber the stratification was as follows: —

- 1) Close to the door, a steeply sloping layer of dromos earth which has intruded through the badly built door-packing.
- 2) A pyramid-shaped layer of brown earth containing some large stones. This earth has fallen in through a circular hole in the roof at the centre of the tomb.
- 3) Three layers of grey, silted clay, separated by thin streaks of *chavara*, and containing potsherds, tomb-gifts, and skeletal remains. The bottom stratum was particularly rich.
- 4) On the left ledge lay an intact burial layer together with pots Nos. 9 and 10.

Layer 3 was not only disturbed by the flowing in of water, but the fragmentary state of the burial gifts — e. g. the earring No. 56 was found alone — shows also that the tomb was sacked before it was flooded. The secondary burial (Layer 4) had almost escaped the destructive effect of the influx mud, but was partly covered by it, and is, therefore, of earlier date. The hole in the roof, through which Layer 2 had intruded, is later than Layer 3, and as the secondary burial was intact, the robbers have not entered that way. Layer 2 contained large stones, and the hole went right up to the layer of Byzantine debris above the tomb. This is proof that the hole was first opened in that epoch, when the tomb was, evidently, used for sanitary purpose. But it also yields a proof that the contents of the tomb were left intact. The *terminus ante quem* for the origin of Layer 3 is, consequently, the Byzantine period, and the same *terminus* for the robbery is the secondary burial. To judge from the stratigraphical evidence of the dromos-filling, the tomb has not been disturbed during the epoch between the last burial of the first period, and the secondary burial. Thus, we have good reasons to presume, that the tomb was sacked by the people who arranged the secondary burial, just as Tomb 7 was robbed by the diggers of the secondary Tomb 7 A.

BURIALS

The skeletal material of the first burial period was not *in situ*. It has, of course, first been turned over by the robbers, and afterwards still more disturbed by the floodwater. The number of skulls, which were all in a rather good state of preservation, shows that there have been at least eleven bodies buried in the first period.

The second burial period was represented by two skeletons lying in outstretched, dorsal positions on the E. ledge, one with his head, and the other with his feet towards the entrance.

In the shaft, Tomb 10 A, was a single burial. The skeleton was roughly *in situ*. It has belonged to a short man, and the body was placed lying on its back in outstretched position with a few tomb-gifts around him. As the tomb is contemporary with the first burial period of Tomb 10 and was left intact during the second, it seems reasonable to presume that it was a servant's tomb.

FINDS (GROUPS: PL. LXXXI, I—3; TYPES: L. OF PL. II)

C h a m b e r

1. White Shaved bobbin-shaped bottle with pointed base; tapering, concave neck; pinched mouth, and handle from rim to shoulder. Height 19.0. — 38.
2. White Shaved bottle, as No. 1. Height 11.7. — 17.
3. Hand-made Bucchero oval jug with high base-ring; narrow, cylindrical neck; a ridge between neck and shoulder; narrow, sharp rim, and handle from rim to shoulder. Fluted body. Height 15.0. — 19.
4. White Shaved bottle, as No. 1. Height 19.7. — 20.
5. Monochrome shallow bowl with flat base; bent-in rim, and a wish-bone handle below rim. Diam. 11.7. Floor.
6. Hand-made Bucchero jug, as No. 3, but with concave, splaying neck, and stilted rim. Piece of rim missing. Height 13.0. — 39.
7. White Shaved bottle, as No. 1. Height 16.2. Floor.
8. Plain White Wheel-made oval jug with flat base; ridges on shoulder; narrowing neck; splaying rim; pinched mouth, and handle from neck to shoulder. Rim missing. Height 25.7. Floor.
9. Plain White Wheel-made oval jug with flat base; tapering neck; bands of ridges around shoulder; thick, splaying rim, and handle from neck to shoulder. Rim chipped. Height 49.5. — 16.
10. Plain, shallow bronze bowl with round base, and thickened rim. Badly preserved. Diam. c. 16.0. Floor.
11. Fragments of a similar bronze bowl. Diam. c. 14.0. Floor.
12. Plain White Wheel-made jug, as No. 8. Rim missing. Height 23.4. Floor.
13. Plain White Wheel-made oval jug with flat base; tapering, convex neck; pinched mouth, and handle from rim to shoulder. Rim chipped. Height 25.9. Floor.
14. Fragments of a bronze bowl, similar to No. 10. Diam. c. 15.0. Floor.
15. White Shaved bottle, as No. 1. Handle missing; shoulder smashed. Height 16.5. Floor.
16. White Shaved bottle, as No. 1. Height 17.3. Floor.
17. White Shaved bottle, as No. 1. Height 17.5. Floor.
18. Bucchero jug, as No. 6, but with narrow, concave neck. Height 10.3. — 21.
19. Plain White Wheel-made shallow bowl with low base-ring; an impressed line below rim, and two string-holes immediately below rim. Diam. 9.2. Floor.
20. Levanto-Helladic flat bowl with base-ring; raised rim, and two horizontal handles at rim. An encircled spiral inside the bottom. Mat paint. Handles missing. Diam. 15.3. Floor.
21. Hand-made Bucchero jug, as No. 3, but with lower base-ring, and tapering neck. Height 12.0. — 8.
22. Hand-made Bucchero jug, as No. 3. Piece of shoulder missing. Height 14.1. Floor.
23. Fragments of a bronze bowl, similar to No. 10. Floor.
24. Plain White Wheel-made jug, as No. 13. Height 29.7. Floor.
25. Levanto-Helladic pear-shaped amphoriskos with tall, narrow base; wide, short, concave neck; stilted rim, and three horizontal handles on shoulder. Encircling lines around rim, neck, shoulder, body, and base; painted handles, and a band of V-ornaments between handles. Height 26.8. — 32.
26. Plain White Wheel-made wide crater with flat base; short, wide, cylindrical neck, and two handles from rim to shoulder. Almost half the vase missing. Height 15.4. — 38.
27. Deep, plain bronze bowl with round base, and thickened rim. Badly preserved. Diam. c. 20.5. — 2.
28. Shallow, plain bronze bowl with round base and thickened rim. Badly preserved. Diam. 18.5. — 0.
29. Fragments of a bronze bowl, as No. 28. Diam. 15.2. — 11.
30. Levanto-Helladic bowl, as No. 20. Encircling lines outside, and an encircled spiral inside the bottom. Diam. 17.0. Floor.
31. White Shaved bottle, as No. 1. Height 17.3. Floor.
32. Levanto-Helladic pear-shaped stirrup-vase with concave, narrow neck; two handles from rim to shoulder, and a spout between handles. Decorated as No. 25, but with a pattern of chevrons on shoulder. Spout and one handle missing. Height 16.4. Floor.
33. Levanto-Helladic shallow bowl with base-ring; splaying rim, and handle from rim to body. Encircling lines around rim and base, and a wavy line below rim. Diam. 11.2. Floor.
34. White Shaved bottle, as No. 1. Height 17.0. Floor.
35. Levanto-Helladic amphoriskos, as No. 25, but with a band of ladder-pattern between handles. Height 15.7. Floor.
36. Plain White Wheel-made shallow bowl with base-ring and in-turned rim. Piece of rim and body missing. Rim chipped. Diam. 20.6. Found on No. 37.
37. Base-ring II conical bowl with abruptly splaying sides; raised, in-turned rim, and a curved, knobbed, wish-bone handle below rim. Half the rim and handle missing. Diam. 15.8. Floor.
38. Base-ring II oval jug with large base-ring; tall, cylindrical neck; a ridge between neck and shoulder, and a flat, incised handle from neck to shoulder. Vertical, white stripes on body. Upper part of neck missing. Height 20.9. Floor.
39. Base-ring II bowl, as No. 37. Diam. 14.2. Floor.
40. Plain White Wheel-made bowl, as No. 36, but with an oblong string-hole projection at rim. Rim chipped. Diam. 19.2. Found on No. 41.
41. Plain White Wheel-made bowl, as No. 40. Rim chipped. Diam. 20.2. Floor.
42. Plain White Wheel-made bowl, as No. 40. Rim chipped. Diam. 20.0. Floor.
43. Base-ring II bowl, as No. 39. Diam. 15.6. Floor.
44. Levanto-Helladic amphoriskos, as No. 25. Paint worn. Height 17.3. Floor.

- 45. Plain White Wheel-made conical bowl with low base-ring. Plain rim, and no handle. Diam. 14.0. Found on No. 46.
- 46. White Shaved bottle, as No. 1. Base missing. Height 16.5. Floor.
- 47. Plain White Hand-made oval jug with large, flat base; distinct shoulder; cylindrical neck; splaying, pinched mouth; thick rim, and handle from rim to shoulder. Height. 30.9. Floor.
- 48. Plain White Hand-made wide crater on high foot; out-turned, flat rim, and a horizontal handle with two knobs on shoulder. Height 16.9. Floor.
- 49. White Shaved bottle, as No. 1. Height 14.6. Floor.
- 50. Hand-made Bucchero jug, as No. 6. Height 11.8. Floor.
- 51. Levanto-Helladic shallow bowl with base-ring, and straight, splaying sides. Encircling lines around body. No handles. Mat paint. Diam. 10.6. Floor.
- 52. Plain White Wheel-made jug, as No. 8. Height 27.4. — 10.
- 53. Plain White Wheel-made jug, as No. 13, but with wider base. Height 21.8. — 10.
- 54. Hand-made Bucchero jug, as No. 3, but with tapering neck. Height 18.7. — 10.
- 55. White Shaved bottle, as No. 1. Height 16.8. Floor.
- 56. Crescent-shaped plain, solid earring of gold. Diam. 1.8. — 47.
- 57. Gold strip with convex sides and rounded ends pierced by holes. Length 7.0. — 47.
- 58. Strip of gold leaf with straight sides and rounded ends, pierced by holes. Length 8.75. Width 1.15. Floor.
- 59. Biconical spindle-whirl of stone with a hole through the longitudinal axis; decorated with encircled dots. Length 1.4. Floor.
- 60. Circular button of ivory with one flat, plain, and one convex, fluted side. In the centre is an oval hole crossed by two bronze wires which pass through small holes

- in the button, and project considerably on the back; it has probably been a mounting of the drawer of a wooden chest. Diam. 4.4. Floor.
- 61. Circular spindle-whirl of stone with one flat, and one convex side, and a hole through the centre. A border of framed semicircles around the edge. Diam. 3.7. Floor.
- 62. Plain, circular disc of ivory. Diam. 5.4. Floor.
- 63. Cylinder of white paste with slightly curved hatchings, suggesting trees or twigs. Length 1.5. Found in the sieves.

T o m b I o A

- 1. Plain White Wheel-made bowl with flat base; distinct rim, and two string-holes through rim. Diam. 12.9. Floor.
- 2. Levanto-Helladic pear-shaped amphoriskos with narrow, raised base; short, wide, concave neck; stilted rim, and three horizontal handles on shoulder. Encircling lines around rim, neck, and body; a band of V-shaped ornaments between handles. Dark, lustrous paint. Height 16.0. Floor.
- 3. Plain White Wheel-made jug with flat base; cylindrical neck; pinched mouth, and handle from rim to shoulder. Height 20.2. Floor.
- 4. Plain White Wheel-made jug with flat base; cylindrical neck; ridge below neck; pinched mouth, and handle from rim to shoulder. Height 15.6. Floor.
- 5. Base-ring II bowl with raised rim and a curved wish-bone handle below rim. Diam. 16.3. Found in No. 6.
- 6. White Slip II hemispherical bowl with in-turned rim, and a triangular wish-bone handle below rim. Bands of ladder-pattern around rim, and from rim to base; a dotted line below rim; transverse lines on handle. Diam. 21.0. Floor.
- 7. White Shaved bobbin-shaped bottle with pointed base; cylindrical neck; pinched mouth, and handle from rim to shoulder. Height 20.6. Floor.
- 8. White Shaved bottle, as No. 7. Height 17.6. Floor.

A summary of the Object Register and of the stratigraphical data gives the following diagram:

	P o t t e r y										B r o n z e	G o l d	S t o n e	I v o r y	G l y p t i c s
	H a n d - m a d e					W h e e l - m a d e									
	Base-ring II	Wh. Shaved	Pl. Wh.	Mono-chrome	Wh. Sl. II	Bucchero	Pl. Wh.	Levanto-Helladic	Bowls	Earring					
1st burial period	37	1. 2	47	5		3. 6	8. 12	20. 25	11. 14	56	57 58	59 61	60	62	63
	38	4. 7	48			18. 21	13. 19	30. 32	23. 27						
	39	15. 16				22. 50	24. 26	33. 35	28. 29						
	43	17. 31				54	36. 40	44. 51							
		34. 46					41. 42								
	49. 55					45. 52									
						53									
	-4	-12	-2	-1		-7	-13	-8	-6	-1	-2	-2	-1	-1	-1
2nd burial period							9		10						
							-1		-1						
T. 10 A	5	7. 8			6		1. 3. 4		2						
	-1	-2			-1		-3		-1						

CHRONOLOGY

The first burial period comprehends the majority of the finds. The group is characterized by the unusually frequent occurrence of Bucchero Ware, which points to a decidedly late date. The Plain White pots Nos. 13, 24, 52 are also typologically late. The group must belong to the end of Late Cypriote II. Tomb 10 A can be assigned to the same date, but the second burial in the chamber ought probably to be dated to Late Cypriote III.

TOMB 11 (Figs. 195:7—9; 198; 199)

	SIZE			
	Length	Width	Depth	Height
Dromos	1.46	1.14	0.82	—
Stomion	0.20	0.85	—	0.58
Chamber	2.75	2.07	—	c. 1.40
Tomb 11 A	1.72	0.92	0.35	—

SHAPE

The connection between Tomb 11 and Tomb 11 A is the same as that between Tomb 7 and 7 A, i. e., the latter is a simple shaft dug in the earth above the former. The dromos of the main tomb is a small shaft with rounded sides and flat bottom. In the semicircular back wall, a step leads down from the surface of the rock. The door-packing consisted of small, irregular stones, and was not very compact. The stomion is short, and opens on to a roughly rectangular chamber with rounded corners. The back part of the chamber is raised some 0.20 m. so as to form a broad ledge, and the stomion drops by means of two abrupt steps, down to the level of the chamber floor. The walls are vertical, and the roof, which was found in a rather damaged state, had apparently been flat. Thus the shape of the chamber contrasts with the majority of the other tombs, and is of a more regular and geometric type.

STRATIFICATION

The surface of the natural rock was found at a depth of about 3.00 m., and the floor of the chamber lay about 5.00 m. below the surface of the earth. It was therefore a rather difficult excavation, and the bottom layers of the chamber were lying approximately on the level of the ground water. The humidity of the soil was considerable also in the dromos. In the narrow shaft, sunk from the surface to the bottom of the dromos, a stratification from the different epochs could be traced.

The Byzantine layer had a thickness of 1.35 m., and consisted of mixed debris without any preserved architectural remains. Below this layer was found the shaft Tomb 11 A. It had been dug down from a curved layer of earth, *chavara*, and gravel, which could be dated to the late Bronze Age, thanks to occasional finds of potsherds. In the shaft were three strata: one burial layer with skeletal remains; a layer of fine, loose earth, and a hard-packed



Fig. 198. Enkomi. Tomb II, Section A-A (1); Finds of first, second, and third periods *in situ* (2, 3, 4).

layer of clayey earth mixed with large stones. The latter projected above the edge of the shaft, and formed the apex of the curved layer, surrounding the shaft. It was separated from the Byzantine layer by a thin but unbroken stratum of accumulated earth. The shaft is approximately dated, thanks to the presence of a bronze bowl of the type common during the last centuries of the Bronze Age. It was badly damaged, but coincided in shape with Bowl No. 10 in Tomb 10. The mass of earth between the shaft and the surface of the rock is due to an accumulation earlier than the shaft. Its convex, upper limit shows that it has been a tumulus of piled-up earth, similar to the tumuli noted in Tombs 7 and 10. It was made after the last burial had taken place in the chamber.

In the dromos were four layers of wet clay and *chavara*, separated by a thin streak of ash. On top was a burial layer, containing remains of a skeleton and a pot. It was found at a level 0.20 m. below the front edge of the dromos, and confined to the area above the entrance of the chamber. The two upper layers of clay and *chavara* were stratified obliquely, contrary to the two lower strata. This fact must be due to a partial excavation and refilling of the dromos in connection with a secondary burial. After this last burial in the chamber, the dromos burial took place, and the tumulus was piled up on top of the tomb.

The chamber was almost filled with earth, stratified in several layers and of different provenance. From the top the filling consisted of the following layers: —

- 1) An obliquely sloping, fan-shaped layer of silted-in mud, limited to the area close to the entrance.
- 2) A very thick layer of debris from the roof, covering the whole chamber.
- 3) A sloping layer of clay mixed with *chavara*, starting from the door and spread all over the chamber.
- 4) A burial layer near the back part, and by the side walls of the chamber.
- 5) A wedge-shaped, hard-packed layer of debris and clay, found in the front part of the chamber and thickening towards the entrance. It starts from the threshold of the stomion.
- 6) A roughly horizontal stratum of white *chavara*, strewn as a filling above Layers 8 and 9.
- 7) A layer of silted clay by the back wall, mixed with many tomb-gifts.
- 8) A burial layer in the front part of the chamber.
- 9) A layer of wet and silted clay, filling the deeper part of the chamber and reaching almost to the back wall.
- 10) A thick burial layer, mixed with wet clay and water, covering the whole chamber and resting directly on the rock floor. It thickened considerably towards the back wall.

The interpretation of this stratification is in all essential parts clear. Starting from the bottom layer, we can follow the development of the tomb through several periods. The primary burials are, of course, represented by Layer 10, but this layer is by no means homogeneous. Thus, it is divided into three sections, A, B, and C: one close to the back wall, containing much pottery, piled up and mixed with burial earth, another section on the ledge, and a third covering the deep, front area of the chamber. The burial, represented by Sect-

ion B cannot conveniently have taken place after those of Section C, as the latter obstruct the free passage to the former. Section A shows clear traces of having been removed from its original position. It has been swept away towards the back wall to make room for some later burial, which must have been the burial on the ledge (B). These three burial groups form, consequently, a chronological sequence.

On top of all these primary burials, was accumulated a layer of silted clay (Layer 9) in which some of the tomb-gifts belonging to the first burials were found. On top of this stratum a burial layer was found (Layer 8) just inside the stomion. The tomb-gifts of this period were also only placed in the front part of the chamber. This secondary burial was of limited extent, and did not seem to have comprised more than two bodies.

After some time the chamber was prepared for new burials. They would constitute the third and last burial period of the tomb. The *chavara* layer (6) and the gradually accumulated clay stratum (7) form an approximately horizontal bed, on which the burials took place, represented by Layer 4. It seems beyond doubt, that Layer 6 was purposely brought into the chamber and spread over the main area in order to get a convenient floor for the intended burials. This layer extended almost over the whole chamber, leaving only a narrow area bare in the longitudinal axis of the chamber. An analysis of its burials indicates that it has to be split up into two sub-periods. The earlier of these could be traced in the deepest section of the layer. There were the remains of two much mouldered bodies. These remnants were partly covered by better preserved skeletons, lying on a slightly higher level. They represented the last burials in the chamber, and after they had taken place the chamber was gradually filled by extraneous earth. Layer 1 has intruded through the door-packing, carrying with it the pots Nos. 1—4 which originally belonged to the dromos burial mentioned above.

As stated above, the floor of the chamber lay on the level of the ground water, and therefore the lower layers were all very wet and partly silted. Finds and skeletons had not remained exactly *in situ*, but their positions have, apparently, not undergone any great alterations. Their actual positions, when excavated, indicate the following distribution between the burial periods and their subdivisions:—

Period 1	A	Finds	Nos.	198, 226—252, 254—263, and 266
»	1	B	»	» 155—158, 203—225, and 264—265
»	1	C	»	» 134—154, 159—197, 202, 267—269, and 274
»	2	»	»	» 47—89, and 124—133
»	3	»	»	» 5—46, and 90—123
Dromos burial	»	»	»	» 1—4

Nos. 199—201, 253, and 270—273, found in the sieves, were not attributable to any definite period.

BURIALS

The oldest skeletal remains of the tomb were found in the disturbed bottom layer near the back wall of the chamber. Most of the bones were mouldered. Some vertebrae, a left

hand, and five skulls were found. Four of the latter were piled up in a heap in the right corner. The removed layer, representing burial group 1 A must, consequently, have comprised at least five bodies. The skeletons of the groups 1 B and C also were in a very poor state of preservation. Of the latter nothing was left, except three dark strata lying in the deepest section of the chamber, where the destructive effect of the ground water was greater than in any other part of the chamber. Group 1 B, represented by the burials on the ledge, held three skulls lying towards the right wall. As the burial strata went right over the chamber these bodies seem to have been buried lying side by side in a slightly contracted position in the transverse axis of the chamber.

The skeletons of the second period were not much better than the above. As stated, they had purposely been covered over by Layer 6, and the remains were crushed and much mouldered. Only a single skull was found, but to judge from the thickness of the stratum and the great amount of tomb-gifts, it seems presumable that the remains represent more than one burial.

During the earlier part of the third period three burials took place, but there were very scanty remains of the skeletal material. One skull was found in the left half of the chamber close to the longitudinal axis. It was richly adorned with a diadem (No. 45), a mouth-piece (No. 43), two hair-rings (No. 44), all of gold. A bracelet (No. 46) has apparently belonged to the same body. To the right of this corpse was another, also provided with jewelry (the earrings No. 39). A third skeleton could be traced still further to the right, equipped with three pairs of golden earrings (Nos. 40 and 41). Except for some fragments of the skulls, nothing was left of the two latter bodies.

The last burials of the chamber were slightly better preserved. To this epoch belonged a skeleton in somewhat contracted lateral position, lying near the right side wall, with the feet towards the entrance and the face towards the wall. Among its burial gifts were found the fine ivory boxes, Nos. 34 and 35, and the drinking cup of faience, No. 38.

In the same position, but with its back towards the first skeleton was another body, whose skull was found slightly removed near the right side wall. An ostrich egg (No. 22) was the most remarkable of its tomb-gifts. A third skeleton, also lying in a lateral, contracted position was found by the left side wall with its head close to the corner of the wall. In the centre of the chamber were found fragments of a pelvis, an arm, some ribs, and a skull, all evidently belonging to the same skeleton. The arm was bent at the elbow, indicating the same position as that of the first skeleton, i. e., a lateral, slightly contracted position. Near the back wall was a complete skeleton which had, evidently, been buried in a sitting position with crossed legs and the arms clasping the knees. By the gradual decomposition of the dead body the head had fallen down, and was found upon the thorax. The femora were crossed, and the legs bent at the knees. Finally, two skulls, two femora, some ribs and a cubital bone were found in the right corner by the back wall. They belonged to two removed bodies, to one of which the golden diadem No. 36 had belonged.

The dromos burial was not very well preserved, but still good enough to permit a conclusion as regards its original position. It had been placed on its left side with the head

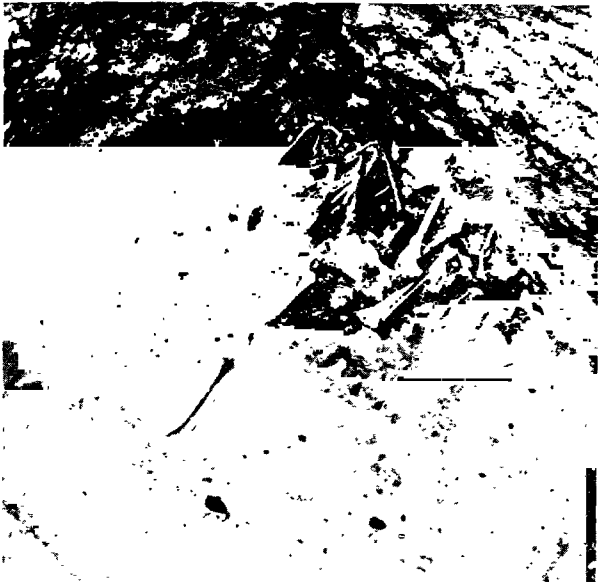

Fig. 199. Enkomi. Tomb 11 A.

Fig. 200. Enkomi. Tomb 13. Interior view with finds *in situ*.

towards the left wall of the dromos. The legs were slightly contracted, and the arms bent at the elbows.

Tomb 11 A — the shaft on top of the tumulus — contained two bodies. One of them was lying in an out-stretched position on its back with the head eastwards. The right side was damaged, and the left arm was slightly bent at the elbow. The left hand rested in its bosom. On its left lay the remains of the other skeleton, which was not *in situ*. The pelvis was broken and the bones lay in a heap around the skull. A single bronze bowl accompanied the bodies as a burial gift.

The layers of ash, found in the dromos (see above) must be due to a purifying or sacrificial ceremony, carried out after the last burial in the chamber. The fire seems to have been confined to the dromos, as no traces of ash were found in the chamber. The dromos burial was very poor, and it seems reasonable to suppose that it was a servant's tomb. Possibly the servant had been sacrificed in connection with the last funeral ceremonies, in a way similar to that noted in Lapithos Tomb 422 (see pp. 243 ff.).

FINDS (GROUPS: PLS. LXXXII—LXXXIV; TYPES: L. OF PL. II)

Chamber

1. Levanto-Helladic squat stirrup-vase with base-ring. Encircling lines around neck and body; a spiral on the knob, and chevrons on shoulder. Reddish, lustrous paint. Height 11.1. — 10.
2. Levanto-Helladic cup with raised base; angular outline, and handle from rim to body. Encircling lines outside and inside. Dark, mat paint. Diam. 7.5. — 23.
3. Levanto-Helladic cup, as No. 2. Red, mat paint. Diam. 8.4. — 25.
4. Levanto-Helladic pear-shaped amphoriskos with narrow raised base; concave neck; splaying rim, and two horizontal handles on shoulder. Mat, red paint. Height 10.9. — 39.
5. Levanto-Helladic pear-shaped jug with narrow, tall base; narrow, concave neck; flaring rim, and three vertical handles on shoulder. Encircling lines around rim, neck, body, and base; broad bands of small, filled crosses between handles. Red, lustrous paint. Height 36.6. — 102.

6. Plain White Wheel-made deep crater with flattened base-ring and rim; two handles from rim to body. Rim chipped; one handle missing. Height 22.0. — 100.
7. White Slip II hemispherical bowl with in-turned rim, and a triangular wish-bone handle below rim. Bands of parallel lines around rim, and from rim to base. Paint worn. Diam. 12.9. Found in No. 6.
8. Plain White Wheel-made crater with high base-ring; bulging sides; wide, cylindrical neck; flat rim, and two handles from rim to shoulder. Height 24.5. — 102.
9. Levanto-Helladic shallow bowl with raised base; curved outline, and handle from rim to body. Encircling lines outside, and an encircled spiral inside. Red, lustrous paint. Diam. 11.6. Found in No. 8.
10. Base-ring II oval jug with tall, cylindrical neck; flaring rim; a ridge below neck, and handle from neck to shoulder. Bands of white lines around neck, and on body. Height 25.4. — 56.
11. Levanto-Helladic globular stirrup-vase with raised base. Encircling lines around neck, body, and base; a hatched band around belly; filled and dotted, semi-circular lines surrounding S-lines on shoulder. Dark red, lustrous paint. Height 15.2. — 77.
12. Levanto-Helladic oval jug with base-ring; concave neck; splaying rim, and handle from rim to shoulder. Encircling lines around rim, neck, belly, and base. Dark, mat paint. Height 24.5. — 106.
13. Levanto-Helladic squat pyxis with flat base; short, concave neck; stilted rim, and three horizontal handles on shoulder. Encircling lines around rim, neck, and body; concentric circles on bottom, and a band of net-work pattern between handles. Red, lustrous paint; worn. Height 10.7. — 96.
14. Levanto-Helladic broad, pear-shaped stirrup-vase with wide base-ring. Encircling lines around neck, body, and base; a fringed band around belly; triangular ornaments and semicircles on shoulder, and concentric circles on the knob. Dark, slightly lustrous paint; decoration worn. Height 16.4. — 99.
15. Levanto-Helladic squat stirrup-vase with base-ring. Encircling lines around neck, body, and base; an encircled dot on the knob, and flower-ornaments with dotted, semicircular lines on shoulder. Red, lustrous paint. Height 11.9. — 92.
16. Levanto-Helladic shallow bowl with raised base; bulging sides, and handle from rim to body. Encircling lines inside. Rim chipped. Red, lustrous paint; worn. Diam. 8.8. Found on top of No. 17.
17. Plain White Wheel-made jug, as No. 12. Height 19.1. — 86.
18. Levanto-Helladic squat stirrup-vase with base-ring. Encircling lines around neck, body, and base, and an encircled dot on the knob. Red, lustrous paint. Height. 9.3. — 90.
19. Plain White Wheel-made jug, as No. 12. Height 22.4. — 96.
20. Levanto-Helladic shallow bowl with flat base; curved sides, and no handle. Encircling lines outside. Red, mat paint; worn. Diam. 11.3. — 102.
21. Base-ring II jug, as No. 10. Height 24.3. — 89.
22. Ostrich egg without any decorations. Put together from several pieces. Length 15.0. — 91.
23. White Shaved bottle with pointed base; concave neck; pinched mouth, and handle from rim to shoulder. Height 18.5. — 96.
24. Levanto-Helladic jug, as No. 5, but with a scale-pattern on shoulder. Dark, lustrous paint. Incised, graphical signs on the handles. Height 34.3. — 80.
25. Levanto-Helladic squat stirrup-vase with large base-ring. Encircling lines around rim, neck, body, and base; a decoration of chevrons, and hooked and dotted lines on shoulder. Dark red, lustrous paint. Height 10.8. — 98.
26. Levanto-Helladic amphora, as No. 4, but with three handles. Encircling lines around rim, neck, body, and base; a band of vertical lines between handles. Dark, lustrous paint; worn. Height 15.3. — 100.
27. Levanto-Helladic squat stirrup-vase with raised base. Encircling lines around rim, neck, shoulder, belly, and base. Dark, lustrous paint. Height 10.1. Found on top of No. 28.
28. Plain White Wheel-made jug, as No. 12. Height 17.5. — 98.
29. Plain White Wheel-made crater, as No. 8. Height 30.9. — 96.
30. Levanto-Helladic shallow bowl with raised base; curved outline, and handle from rim to body. Encircling lines outside and inside. Red, lustrous paint. Diam. 13.7. Found inside No. 29.
31. Plain White Wheel-made crater with base-ring; wide, cylindrical neck; flat rim, and two fluted handles from rim to shoulder. Piece of rim and body missing. Height 27.4 — 88.
32. Base-ring II flat, conical bowl with raised rim, and a curved wish-bone handle at rim. Diam. 16.7. Found inside No. 31.
33. Levanto-Helladic pear-shaped amphora with narrow, raised base; wide neck; flat rim, and two handles from rim to shoulder. Painted neck and base; herring-bone patterns and spirals on rim; framed, vertical, wavy lines on handles, and on the sides two chariots, each driven by two charioteers. The chariots and the men's dresses are dotted, and they stand behind each other; the front man holds the four reins, from which fringes are hanging. The stallions are vigorously drawn with tall necks, large round eyes, and bushy tails. Below their bellies are bands of running spirals. Around and below the handles are ornaments, composed of nautilus-elements; dotted circles; "pillar-trees"; chevrons, and fringed semicircles; all surrounding a curiously shaped animal, half fish, half bird. One side of the amphora is rather worn. Red, lustrous paint. Height 38.7. — 91.

34. Several strips of ivory of different dimensions; decorated with incised concentric circles and framing lines. They have been applied round the edges of a rectangular, wooden chest; complete specimens of such chests are found in Egyptian tombs from the same epoch. The chest can be reconstructed with a length of 27.8. and a height of 10.5. — 88.
35. Cylindrical ivory box with carved ridges round the edges. Damaged. Height 5.3. Diam. 6.5. — 86.
36. Broad diadem of gold leaf with straight edges; rounded corners, and one hole in each corner. The diadem is decorated with groups of continuous spirals in enchased work. Length 15.1. — 96.
37. Fragments of a blue and yellow, shallow bowl of faience.
38. Drinking cup of black and yellow faience in the shape of a deer's head. The head is vividly modelled. The muzzle is contracted and wrinkled, the nostrils are wide open, and the under lip is drawn back. The eyes are large and slightly prominent, and the ears are laid close to the head. All these details indicate that the animal either snorts, or has just got wind of an enemy. The horns are represented tightly pressed against the neck, probably for technical reasons. Muzzle, eyes, horns, and ears are black, as well as the edge of the goblet; the rest is of clear, yellow colour. Cracked here and there, and repaired at the edge. Height 12.5 — 102.
39. A pair of gold earrings consisting of a thin, circular wire with overlapping ends, to which are attached large, hollow pendants in the shape of ornamental and conventionalized bulls' heads. The pendants are decorated with very fine granulations in straight lines, circles, and triangles, and end in balls. Length 3.3 — 99.
40. A pair of crescent-shaped earrings of solid gold. Diam. 2.0. — 99.
41. A pair of earrings, as No. 40. Diam. 2.0. — 99.
42. A pair of earrings, as No. 40. Diam. 1.9. — 99.
43. Oval mouth-piece of gold leaf with a hole at each end. In the centre are two convex lines suggesting lips, surrounded by small, circles probably representing beard and moustaches. On each side of the mouth is a male head in left profile; they are rendered with large wigs and beards, almond-shaped eyes, and small ears: the borders of the face is marked by a line. Enchased work. Length 9.2. — 97.
44. Two spiral hair-rings of solid gold. Diam. 2.4. — 97.
45. Diadem of gold leaf with almost straight sides; rounded corners, and a hole in each corner. The diadem is decorated with fifteen male heads, exactly similar to those of No. 43; four of them are inverted, and two much worn. Around the edge of the diadem is a border of small circles. Enchased work. Length 12.8. — 97.
46. Circular bracelet of solid gold with overlapping ends. Diam. 5.5. — 100.
47. Plain White Wheel-made bowl with flat base, and a horizontal, cylindrical string-hole handle at rim. Diam. 17.9. Layer 8.
48. Plain White Wheel-made jug with flat base; concave neck; handle from rim to shoulder, and a tubular spout on shoulder opposite the handle. Repaired. Rim chipped. Height 9.5. Layer 8.
49. Plain White Wheel-made jug, as No. 48. Height 9.5. Layer 8.
50. Levanto-Helladic squat, globular stirrup-vase with raised base. Encircling lines around rim, neck, body, and base; an encircled dot on the knob, and vertical lines on shoulder. Dark, lustrous paint; much worn. Height 11.8. Layer 8.
51. Hand-made Bucchero oval jug with base-ring; cylindrical neck; splaying rim, and handle from rim to shoulder. A ridge around base of neck, and fluted body. Surface worn. Height 14.4. Layer 8.
52. Plain White Wheel-made globular jug with flat base; splaying neck, and handle from below rim to shoulder. Height 16.8. Layer 8.
53. Plain White Hand-made globular jug with flat base; splaying neck; pinched mouth, and handle from rim to shoulder. Height 16.2. Layer 8.
54. Plain White Wheel-made plate with raised base; a ridge on rim, and a small, horizontal handle at rim. Diam 14.8. Layer 8.
55. Levanto-Helladic squat, globular stirrup-vase with raised base. Encircling lines around body; concentric semicircles, and dotted lines on shoulder. Neck, knob, and handles missing. Red, lustrous paint, worn. Height 8.2. Layer 8.
56. Levanto-Helladic stirrup-vase, as No. 55. Rim, knob, and one handle missing. Flower-ornaments on shoulder. Red, lustrous paint; worn. Height 11.2. Layer 8.
57. Base-ring II jug, as No. 10. Height 21.6. Layer 8.
58. Levanto-Helladic amphora, as No. 33. Red neck and base; herring-bone pattern on rim; encircling lines around belly, and vertical zigzag lines on shoulder. Red, lustrous paint. Height 29.3. Layer 8.
59. Base-ring II bowl, as No. 32. Diam. 11.9. Found in No. 58.
60. Levanto-Helladic squat stirrup-vase with flat base. Clumsy shape; surface worn. Decoration obliterated. Height 9.1. Layer 8.
61. Plain White Wheel-made oval jug with base-ring; concave neck, and handle from rim to shoulder; a button-ornament at root of handle. Some pieces missing. Height 14.8. Layer 8.
62. Plain White Wheel-made globular jug with flat base; concave neck, and handle from rim to shoulder. Height 15.3. Layer 8.
63. Plain White Wheel-made jug, as No. 52. Height 18.6. Layer 8.
64. Plain White Wheel-made plate with base-ring; raised rim, and a cylindrical, horizontal string-hole handle at rim. Diam. 20.0. Layer 8.
65. Plain White Wheel-made shallow bowl with flat base, and a horizontal handle below rim. Diam. 11.7. Layer 8.

66. Base-ring I squat jug with wide, cylindrical neck; flat rim, and an arched handle from rim to shoulder. Height 13.5. Layer 8.
67. White Shaved bottle, as No. 23; handle missing. Height 17.3; Found in No. 68.
68. Monochrome shallow bowl with flat base; in-turned rim, and a wish-bone handle below rim. Diam. 11.9. Layer 8.
69. Plain White Wheel-made crater, as No. 8. Height 27.8. Layer 8.
70. Base-ring II bowl, as No. 32. Diam. 15.2. Found in No. 69.
71. Plain White Wheel-made jug, as No. 62. Height 16.0. Layer 8.
72. White slip II bowl, as No. 7. Bands of ladder-pattern around rim, and from rim to base; dotted, vertical lines in their interstices. Paint worn. Diam. 17.5. Layer 8.
73. Plain White Wheel-made oval jug with flat base; wide neck; pinched mouth, and handle from neck to shoulder. Pieces of rim and neck missing. Height 26.1. Layer 8.
74. Plain White Wheel-made wide crater with high base-ring, flat, splaying rim, and two vertical handles on shoulder. Rim chipped. Height 26.3. Layer 8.
75. White Slip II bowl, as No. 72, but without dotted lines. Handle missing. Diam. 13.3. Layer 8.
76. Levanto-Helladic amphoriskos, as No. 26, but with a band of V-shaped ornaments between the handles. Dark red, lustrous paint. Height 17.0. Layer 8.
77. Plain White Wheel-made shallow bowl with flat base; distinct rim, and a cylindrical, horizontal string-hole handle at rim. Diam. 13.3. Layer 8.
78. Plain White Hand-made shallow bowl with flat base; in-turned rim, and a horizontal handle below rim. Diam. 10.2. Found in No. 79.
79. Base-ring II bowl, as No. 32. Diam. 15.8. Found in No. 80.
80. White Slip II bowl, as No. 72. Paint worn. Diam. 20.0. Layer 8.
81. Plain White Wheel-made jug, as No. 62. Height 19.5. Layer 8.
82. Plain White Wheel-made jug, as No. 62, but with a ridge below neck. Height 15.7. Layer 8.
83. Plain White Wheel-made jug, as No. 52. Height 17.7. Layer 8.
84. Levanto-Helladic amphoriskos, as No. 26, but with vertical handles. Red, lustrous paint. Height 14.4. Layer 8.
85. Levanto-Helladic cup with raised base; angular outline, and a narrow, horizontal handle on body. Red, lustrous paint. Diam. 7.3. Layer 8.
86. Levanto-Helladic shallow bowl with raised base; curved outline, and a handle from rim to body. Encircling lines outside, and a band of lying S-ornaments below rim. Red, lustrous paint. Diam. 11.7. Layer 8.
87. White Slip II bowl, as No. 7. Decoration obliterated. Diam. 15.7. Layer 8.
88. Plain White Wheel-made jug, as No. 62. Height 19.3. Layer 8.
89. Levanto-Helladic bowl, as No. 86. Diam. 12.7. Layer 8.
90. Base-ring II jug, as No. 10. Two vertical, incised lines on handle. Height 20.4. — 94.
91. Base-ring II jug, as No. 10. A vertical, incised line on handle. Height 19.6. — 94.
92. Plain White Wheel-made oval jug with flat base; a ridge below neck; cylindrical neck; pinched mouth, and handle from rim to shoulder. Height 19.2. — 94.
93. Levanto-Helladic bowl, as No. 86. Encircling lines and bands around rim and body, and an impressed circle on base. Diam. 11.5. — 95.
94. Hand-made Bucchero jug, as No. 51. Height 14.9. — 96.
95. Plain White Wheel-made crater with high, narrow base-ring; wide, concave neck, and two fluted handles from rim to shoulder. Height 21.9. Found in No. 96.
96. Base-ring II bowl, as No. 32. Piece of handle missing. Diam. 16.4. — 98.
97. Red Lustrous Wheel-made lentoid bottle with one flat side; short, narrow neck; bulging rim, and handle from neck to body. Height 17.4. — 94.
98. Base-ring II bowl, as No. 32. Piece of handle missing. Diam. 16.7. — 96.
99. Base-ring II hemispherical bowl with plain rim, and a vertical string-hole handle at rim. Diam. 8.9. — 94.
100. Plain White Wheel-made shallow bowl with flat base; indented rim, and a string-hole handle at rim. Diam. 11.3. — 97.
101. Levanto-Helladic squat pyxis with flat base; oblique shoulder; short, concave neck; stilted rim, and two horizontal handles on shoulder. Handle missing. Dark, lustrous paint; worn. Height 6.6 — 97.
102. White Shaved bottle, as No. 23. Height 17.4. — 97.
103. Plain White Wheel-made jug, as No. 92. Neck and handle missing. Height 20.1. — 90.
104. Base-ring II jug, as No. 10, but with widening neck. Oblique longitudinal axis. Handle as No. 90. — 91. Height 24.0.
105. Plain White Wheel-made jug, as No. 92. Height 20.4.c. — 94.
106. Levanto-Helladic squat miniature jug with flat base; concave neck, and handle from rim to shoulder. Encircling lines around rim, neck, and body. Dark, slightly lustrous paint. Height 6.0. — 94.
107. Fragments of a Plain White Wheel-made crater. — 91.
108. Levanto-Helladic squat stirrup-vase with base-ring, and angular outline. Encircling lines around body; an encircled dot on the knob, and concentric, short segments on shoulder. Neck missing. Red, lustrous paint. Height 9.1. — 93.
109. White Shaved bottle, as No. 23. Height 19.7. — 93.
110. Levanto-Helladic bowl, as No. 86. Encircling lines around rim and base; chevrons and spirals around body. Red, lustrous paint. Diam. 12.1. — 93.

111. Plain White Wheel-made oval jug with flat base; wide, concave neck; pinched mouth, and handle from rim to shoulder. Height 26.3. — 98.
112. Levanto-Helladic amphoriskos, as No. 26. Encircling lines around rim, neck, body, and base; a scale-pattern between handles. Red, lustrous paint; worn. Height 15.5. — 96.
113. Levanto-Helladic bowl, as No. 86. Encircling lines outside and inside. Red, lustrous paint. Diam. 12.1. — 90.
114. Plain White Wheel-made shallow bowl with base-ring, and in-turned rim. No handle. Diam. 21.0 — 92.
115. Monochrome biconical jug with flat base, an incised line below neck; splaying neck; thick rim; pinched mouth, and handle from rim to shoulder. Two incised, vertical lines on handle; an incised cross at top of handle. Height 14.6. — 92.
116. Plain White Wheel-made bowl, as No. 100. Diam. 12.6. — 92.
117. White Shaved bottle, as No. 23. Height 17.2. — 90.
118. Plain White Wheel-made crater with base-ring; angular outline; flat rim, and two vertical handles on sides. Some pieces missing. Height 22.4. — 93.
119. Base-ring II bowl, as No. 32. Piece of handle missing. Diam. 17.0. — 93.
120. Plain White Wheel-made shallow bowl with flat base; in-turned rim, and a horizontal handle at rim. Diam. 10.7. — 92.
121. Monochrome bowl, as No. 68. Piece of handle missing. Diam. 10.5. — 96.
122. Base-ring II jug, as No. 10. Neck and handle missing; base chipped. Height 18.2. — 96.
123. Levanto-Helladic spherical bottle with base-ring; tall, narrow neck; splaying rim, and two handles from neck to shoulder. Encircling lines around neck; vertical, concentric circles covering both sides of body. Red, lustrous paint. Height 11.1. — 97.
124. Levanto-Helladic bowl, as No. 86. Dark red, lustrous paint. Diam. 11.7. Layer 8.
125. Levanto-Helladic squat pyxis, as No. 13. Encircling lines and concentric circles, as No. 13, and a zigzag band between handles. Red, lustrous paint; worn. Height 8.5. Layer 8.
126. Levanto-Helladic squat stirrup-vase with base-ring. Encircling lines around rim, neck, and body; an encircled dot on the knob. Bottom missing. Height 9.9. Layer 8.
127. Levanto-Helladic pear-shaped stirrup-vase. Encircling lines around rim, neck, and body; chevrons, dotted semicircles, and N-shaped lines on shoulder. Base missing. Red, lustrous paint. Height 12.3. Layer 8.
128. Base-ring II oval jug with short, splaying neck; thick rim; a ridge below neck, and handle from rim to shoulder. Height 15.3. Layer 8.
129. Base-ring II bowl, as No. 32. Piece of handle missing. Diam. 16.3. Layer 8.
130. Levanto-Helladic squat miniature jug, as No. 106. Height 6.4. Layer 8.
131. Plain White Wheel-made shallow bowl with flat base; in-turned rim, and a horizontal handle at rim. Piece of rim and handle missing. Diam. 9.7. Layer 8.
132. Plain White Wheel-made crater with base-ring; wide, cylindrical neck; flat rim, and two handles from rim to shoulder. Height 23.5. Layer 8.
133. Base-ring II bowl, as No. 32. Diam. 16.2. Found in No. 132.
134. White Shaved bottle, as No. 23. Height 16.9. Found on No. 135.
135. Plain White Wheel-made shallow bowl with a string-hole handle at rim. Diam. 13.2. Floor.
136. White Shaved bottle, as No. 23. Handle missing. Height 16.3. Floor.
137. White Shaved bottle, as No. 23. Height 19.0. Floor.
138. Plain White Wheel-made globular jug with raised base; an incised line below neck; concave neck, and handle from rim to shoulder. Height 13.2. Floor.
139. Base-ring II jug, as No. 128. Height 11.9. Floor.
140. Plain White Wheel-made globular jug with flat base; distinct shoulder; concave neck, and handle from rim to shoulder. Height 17.2. Floor.
141. White Shaved bottle, as No. 23, but with slightly rounded base. Height 16.8. Floor.
142. Levanto-Helladic squat, biconical stirrup-vase with flat base. Encircling lines around rim, neck, body, and base. Clumsy shape. Dark, lustrous paint; worn. Height 9.8. Floor.
143. Plain White Wheel-made shallow bowl with raised base; indented rim, and a horizontal, cylindrical string-hole handle on rim. Rim chipped. Diam. 13.9. Floor.
144. Base-ring II jug, as No. 128. Height 12.5. Floor.
145. Levanto-Helladic squat, rounded stirrup-vase with raised base. Encircling lines around rim, neck, and body. Dark, lustrous paint; almost obliterated. Height 10.7. Floor.
146. White Shaved bottle, as No. 23. Height 16.7. Floor.
147. Plain White Wheel-made globular jug with flat base; concave neck; raised rim, and handle from rim to shoulder. Height 15.2. Floor.
148. Plain White Wheel-made bowl, as No. 143. Diam. 9.4. Floor.
149. Levanto-Helladic squat, biconical stirrup-vase with flat base. Encircling lines around rim, neck, and body; a circle on the knob. Dark, lustrous paint; much worn. Height 8.3. Floor.
150. Base-ring II bowl, as No. 32. Diam. 14.1. Floor.
151. Levanto-Helladic squat, biconical jug with raised base; narrow, concave neck; splaying rim, and two curved handles from neck to shoulder. Dark red, lustrous paint; much worn. Height 8.7. Floor.
152. White Shaved bottle, as No. 23. Height 14.4. Floor.
153. Levanto-Helladic bowl, as No. 86. Encircling lines around rim and body, and a chain of loops below rim. Dark red, lustrous paint. Diam. 11.1. Floor.
154. Red Slip Wheel-made bowl with base-ring; distinct rim, and a cylindrical, horizontal string-hole handle at rim. Rim chipped. Diam. 19.0. Floor.

155. Plain White Wheel-made oval jug with flat base; cylindrical neck; pinched mouth, and handle from rim to shoulder. Height 27.3. Floor.
156. Plain White Wheel-made jug, as No. 155. Height 26.5. Floor.
157. White Slip I jug with base-ring; very wide, tall, cylindrical neck; indented rim; handle from rim to shoulder, and a projection at top of handle. Bands of ladder-pattern and latticed lozenges on neck and body. Slip and decoration almost obliterated. Projection chipped. Height 27.2. Floor.
158. Base-ring II globular jug with tall, splaying neck; flaring, indented rim; handle from neck to shoulder, and two ridges around neck. Three vertical, incised lines on handle, and two curved relief-lines as front ornament. Rim chipped. Height 27.1. Floor.
159. White Shaved bottle, as No. 23. Height 14.5. Floor.
160. White Shaved bottle, as No. 23. Height 13.8. Floor.
161. Plain White Hand-made oval jug with flat base; cylindrical neck; thick rim, and handle from rim to shoulder. Height 12.8. Floor.
162. Base-ring II bowl, as No. 32. Handle missing. Diam. 16.3. Floor.
163. Levanto-Helladic squat, globular stirrup-vase with base-ring. Encircling lines around rim, neck, body, and base; an encircled dot on the knob; a band of vertical, short lines on shoulder. Dark, slightly lustrous paint; worn. Height 9.8. Floor.
164. Plain White Wheel-made shallow bowl with base-ring, and a string-hole handle at rim. Diam. 21.3. Floor.
165. White Shaved bottle, as No. 23. Height 13.0. Floor.
166. White Shaved bottle, as No. 23. Pieces of neck and handle missing. Height 17.8. Floor.
167. White Shaved bottle, as No. 23. Height 16.3. Floor.
168. Base-ring II oval jug with splaying neck; raised rim, and handle from neck to shoulder. Button-ornaments in relief at top and base of handle; vertical, incised lines on handle. Height 17.3. Floor.
169. Monochrome oval jug with round base; a ridge below neck; slightly splaying neck; pinched mouth, and handle from rim to shoulder. Pieces of base missing. Height 14.3. Floor.
170. White slip II bowl, as No. 7. Bands of ladder-pattern around rim, and from rim to base; dotted lines on rim, and in the interstices of the bands; transverse lines on handles; piece of rim missing. Diam. 19.6. Floor.
171. Levanto-Helladic bowl, as No. 86. Encircling lines around rim and base. Red, lustrous paint. Diam. 10.6. Floor.
172. Monochrome bowl, as No. 68. Diam. 11.3. Floor.
173. Plain White Wheel-made crater with high base-ring; wide, cylindrical neck; flat rim, and two fluted handles from neck to shoulder. Base and rim chipped. Height 20.5. Floor.
174. Base-ring II oval jug with tall, tapering neck; splaying rim; a ridge below neck, and handle from neck to shoulder. Two vertical, incised lines on handle. Oblique longitudinal axis. Height 24.9. Floor.
175. Plain White Wheel-made shallow bowl with base-ring, and a cylindrical, vertical string-hole handle on rim. Piece of rim missing. Diam. 21.7. Floor.
176. Plain White Wheel-made jug, as No. 155. Part of neck and rim missing. Height 27.2. Floor.
177. Levanto-Helladic bowl, as No. 86. Encircling lines around rim and base. Rim chipped. Red, lustrous paint. Diam. 11.5. Floor.
178. Levanto-Helladic bowl, as No. 86. Encircling lines around rim and base, and spirals below rim. Handle missing. Dark, lustrous paint. Diam. 12.7. Floor.
179. White Painted V globular jug with flattened base; wide, cylindrical neck; an arched handle from rim to shoulder, and a tubular spout opposite the handle. Encircling lines around rim, neck, and spout; oblique, parallel lines on shoulder, and vertical lines from belly to base. Height 8.2. Floor.
180. White slip II bowl, as No. 7. Bands of ladder-pattern around rim, and from rim to base; vertical, dotted lines as front ornament; a chain of angular loops below rim, and transverse lines on handle. Piece of rim missing. Diam. 17.9. Floor.
181. White Slip II shallow bowl with flattened base; a small handle on rim. Bands of ladder-pattern around rim, and from rim to base; dotted, vertical lines in their interstices, and short, vertical lines on handle. Diam. 14.4. Floor.
182. Base-ring II bowl, as No. 32. Handle missing. Diam. 11.1. Found on No. 183.
183. Plain White Wheel-made plate with base-ring, and a horizontal, cylindrical string-hole handle at rim. Rim chipped. Diam. 22.4.
184. Levanto-Helladic globular stirrup-vase with raised base. Encircling lines around neck and body; an encircled dot on the knob. Red, lustrous paint; worn. Height 11.0. Floor.
185. White slip II bowl, as No. 7. Bands of ladder-pattern around rim, and from rim to base; small lozenges below rim. Piece of handle missing. Diam. 13.6. Floor.
186. Plain White Hand-made oval jug with flat base; tapering neck; slightly pinched mouth, and an arched handle from rim to shoulder. Height 16.3. Floor.
187. White Shaved bottle, as No. 23. Height 19.9. Floor.
188. Base-ring II bowl, as No. 32. Diam. 17.5. Floor.
189. Plain White Wheel-made plate with base-ring, and in-turned rim. Incomplete. Diam. 21.8. Floor.
190. White Shaved bottle, as No. 23, but with flattened base. Height 14.3. Floor.
191. White Painted V jug, as No. 179. Decoration obliterated. Height 9.7. Floor.
192. Monochrome bowl, as No. 68. Diam. 12.0. Floor.
193. Levanto-Helladic amphoriskos, as No. 26. Encircling lines around rim, neck, body, and base; chevrons between handles; two handles missing. Dark, lustrous paint; worn. Height 18.0. Floor.

194. Base-ring II bowl, as No. 99. Piece of rim missing; surface partly worn. Diam. 11.3. Floor.
195. Base-ring II jug, as No. 168. Base chipped. Height 19.5. Floor.
196. Plain White Wheel-made plate with raised, distinct rim; base-ring, and a cylindrical, horizontal string-hole handle on rim. Diam. 23.4. Floor.
197. Levanto-Helladic squat, globular jug with base-ring; narrow neck; splaying rim, and two handles from neck to shoulders. Encircling lines around rim, neck, body, and base; two wavy lines on shoulder. Dark red, lustrous paint. Height 10.7. Floor.
198. Oval mouth-piece of gold leaf with two holes at each end. The centre is decorated with two convex bands suggesting the outline of the lips, and around the edge are running spirals. Enchased work; slightly damaged. Length 10.5. Floor.
199. Fluted gold bead. Diam. 0.9. Found in the sieves.
200. Cylinder of white faience with gold mountings. The representation is very badly worn and hardly possible to interpret. It seems probable that what is shown is a scene with running animals divided into two friezes. One gold mounting missing. Length 1.4. Found in the sieves.
201. Conical seal of lead, pierced by a hole through top. The representation is a bucranium with a circle enclosed by the horns. Height 1.5. Found in the sieves.
202. Levanto-Helladic jug, as No. 106. Dark, lustrous paint. Height 6.8. Floor.
203. Levanto-Helladic bowl, as No. 86. Encircling lines around rim and base, and a band of N-shaped ornaments below rim. Red, lustrous paint. Diam. 10.5. Floor.
204. White slip II bowl, as No. 7; decorated as No. 180. Handle missing; paint worn. Diam. 18.3. Floor.
205. White Shaved bottle, as No. 23. Height 19.2. Floor.
206. White Shaved bottle, as No. 23. Height 19.0. Floor.
207. White slip II bowl, as No. 7; decorated as No. 181. Paint worn. Diam. 17.6. Floor.
208. White Shaved bottle, as No. 23. Height 16.4. Floor.
209. White Shaved bottle, as No. 23. Height 20.5. Floor.
210. Levanto-Helladic amphoriskos, as No. 26. Encircling lines around rim, neck, body, and base; a net-work pattern between handles. Height 14.2. Floor.
211. Plain White Wheel-made plate with base-ring, and raised rim. Rim chipped. Diam. 21.6. Floor.
212. Red Slip Wheel-made bowl with high base-ring, and indented rim. Diam. 13.0. Floor.
213. Levanto-Helladic jug, as No. 123. Encircling lines around rim, neck, and body. Red, lustrous paint; much worn. Height 10.4. Floor.
214. Base-ring II jug, as No. 10. Height 24.5. Floor.
215. Levanto-Helladic stirrup-vase, as No. 14. Encircling lines around rim, neck, and body; a spiral on the knob, and chevrons on shoulder. Dark, lustrous paint. Height 17.5. Found on No. 216.
216. Plain White Wheel-made shallow bowl with base-ring; in-turned, distinct rim, and a horizontal, cylindrical string-hole handle at rim. Diam. 23.2. Floor.
217. Base-ring II jug, as No. 158. Rim chipped. Height 30.2. Floor.
218. Levanto-Helladic bowl, as No. 86; decorated as No. 203. Diam. 13.0. Floor.
219. Base-ring II jug, as No. 10. Height 27.2. Floor.
220. Plain White Wheel-made jug with flat base; a ridge below neck; cylindrical neck; pinched mouth, and an indented handle from rim to shoulder. Height 19.5. Floor.
221. Levanto-Helladic shallow bowl, as No. 86. Dark red, lustrous paint. Diam. 11.3. Floor.
222. Base-ring II bowl, as No. 32. Diam. 8.8. Floor.
223. Plain White Wheel-made crater with low base-ring; short, concave neck; flat rim, and two handles from rim to shoulder. Height 21.5. Floor.
224. Base-ring II bowl, as No. 32. Diam. 16.8. Found in No. 223.
225. Base-ring II jug, as No. 10. Two vertical, incised lines on handle. Rim chipped. Height 24.0. Floor.
226. Monochrome bowl, as No. 68. Handle, and piece of rim missing. Diam. 11.4. Found in No. 227.
227. White Slip II bowl, as No. 7. Decoration obliterated. Diam. 16.9. Found on No. 228.
228. Base-ring II jug, as No. 10. Height 26.5. Floor.
229. Red Lustrous Wheel-made lentoid bottle with tall, narrow neck; thick rim, and handle from neck to body. Paint worn. Height 25.5. Found in No. 230.
230. Plain White Wheel-made shallow bowl with base-ring, and a string-hole handle at rim. Diam. 15.2. Floor.
231. Base-ring II pear-shaped amphoriskos with concave, narrow neck; splaying rim, and three horizontal handles on shoulder. Height 9.2. Found in No. 232.
232. Monochrome bowl, as No. 68. Diam. 11.5. Floor.
233. Base-ring II jug, as No. 10. Two vertical, incised lines on handle. Height 26.9. Floor.
234. Plain White Wheel-made bowl with flat base, and two string-holes at rim. Diam. 7.5. Floor.
235. Plain White Wheel-made jug, as No. 155. Rim chipped. Height 23.2. Floor.
236. Base-ring II jug, as No. 10. Two incised, vertical lines on handles. Rim chipped. Height 27.3. Floor.
237. Hand-made Bucchero oval jug with base-ring; cylindrical neck; splaying rim, and handle from rim to shoulder. A ridge below neck, and vertical ridges from neck to base. Height 15.8. Floor.
238. White painted V oval jug with flat base; cylindrical neck; handle from rim to shoulder, and a tubular spout opposite the handle. Decoration obliterated. Height 12.6. Floor.
239. Fragments of a shallow bronze bowl with round base, and stilted rim. Much corroded. Floor.
240. Levanto-Helladic bowl, as No. 6. Dark, lustrous paint. Diam. 13.9. Floor.
241. Base-ring II deep, conical crater with oblique shoulder;

- flat rim, and two vertical handles on shoulder. Two horizontal ridges below shoulder. Height 16.4. Floor.
242. Base-ring II bowl, as No. 32. Diam. 17.9. Found in No. 241.
243. Monochrome oval jug with flattened base; cylindrical neck; pinched mouth, and handle from rim to shoulder. Height 15.6. Floor.
244. Base-ring II jug, mainly as No. 10. Height 27.8. Floor.
245. Monochrome shallow bowl with round base, and a horizontal handle below rim. Piece of rim missing. Diam. 11.1. Floor.
246. Black Slip III oval jug with flattened base; cylindrical neck; slightly pinched mouth, and handle from rim to shoulder. Paint almost obliterated. Height 16.3. Floor.
247. Fragments of a Base-ring I deep bowl with high, raised rim, and a wish-bone handle below rim. Floor.
248. Base-ring II deep, conical bowl with raised rim, and a curved wish-bone handle below rim. Diam. 12.4. Found inside No. 247.
249. Fragments of a bronze bowl, as No. 239. Badly corroded. Floor.
250. Monochrome oval jug with round base, cylindrical neck; pinched mouth, and handle from rim to shoulder. Height 15.0. Found inside No. 149.
251. White Slip II bowl, as No. 7. Bands of ladder-pattern around rim, and from rim to base; transverse lines on handle. Decoration almost obliterated. Diam. 14.0. Floor.
252. Base-ring II jug, as No. 244. Height 22.2. Floor.
253. Cylinder of steatite. The representation consists of two men standing opposite each other with raised right hands. Between the legs of the men are dots; and between them stands on its hind-legs a goat. Behind the right-hand man, run two goats vertically; between their legs are encircled dots, and above the back of the upper goat is another dot. Behind the left-hand man are two bucrania, the upper one with a dot between the horns. Below the bucrania is another running goat. Length 2.4. Found in the sieves.
254. White Slip II bowl, as No. 7; decorated as No. 251. Diam. 14.2. Found on top of No. 255.
255. Base-ring II jug, as No. 244. Height 25.3. Floor.
256. Levanto-Helladic bowl, as No. 86. Incomplete. Red, lustrous paint. Diam. 12.7. Floor.
257. Black Lustrous Wheel-made jug with squat, angular body; base-ring; wide, tapering neck; small, stilted rim, and handle from rim to shoulder. Paint worn. Height 18.5. Floor.
258. Base-ring I bowl, as No. 247. Floor.
259. Fragments of a white and yellow bowl of faience. Floor.
260. Plain White Wheel-made shallow bowl with flat base; indented rim, and a string-hole handle on rim. Diam. 12.5. Floor.
261. White Slip II bowl, as No. 7; decorated as No. 180. Piece of rim missing. Decoration almost obliterated. Diam. 17.6. Floor.
262. Plain White-Wheel-made plate with low base-ring; indented rim, and a horizontal, cylindrical string-hole handle at rim. Diam. 22.1. Floor.
263. Base-ring II jug, as No. 10. Height 23.5. Floor.
264. Hand-made Bucchero miniature jug, as No. 237. Height 8.4. Floor.
265. Black Slip III oval jug with tall, tapering neck; flattened base, slightly splaying rim, and handle from rim to shoulder. Paint almost obliterated. Height 17.5. Floor.
266. Plain, circular ivory disc with an incised line round the edge. Damaged. Diam. 5.5. Floor.
267. Base-ring I squat, rounded jug with tall, narrow neck; funnel-rim, and handle from neck to shoulder. Two handle-ridges. Height 13.5. Floor.
268. Plain White Wheel-made shallow bowl with base-ring, and indented rim. Rim chipped. Diam. 11.8. Floor.
269. Plain White Wheel-made globular jug with base-ring. Rim and handle missing. Height 13.5. Floor.
270. Levanto-Helladic biconical miniature jug with flat base; narrow, concave neck; beaked mouth, and handle from rim to shoulder. Encircling lines around rim, neck, body, and base. Red, lustrous paint. Height 6.2. Found in the sieves.
271. Gold bead in the shape of a seed. Found in the sieves.
272. Ivory pin with tapering end, and an engraved line around the thicker end. Length 9.6. Found in pieces in the sieves.
273. Cylinder of green steatite. The representation consists of two goats standing on their hind-legs with strongly bent-back heads. Between them runs another goat, above the back of which flies a bird. At the right end of the representation are some scratchings, probably a graphical sign. Length 1.8. Found in the sieves.
274. Monochrome jug, as No. 250. Height 12.6. Found on top of No. 173.

T o m b 11 A

1. Fragments of a bronze bowl.

D r o m o s

1. White Slip II hemispherical bowl with in-turned rim, and a triangular wish-bone handle below rim. Bands of ladder-pattern around rim, and from rim to base; transverse lines on handle. Paint worn. Diam. 13.9.

CHRONOLOGY

The richly stratified tomb covers over a long time, but there is one characteristic common to all the sub-periods — the Levanto-Helladic Ware. Nothing is, therefore, older than Late Cypriote II, but Period I A belongs to the early part of the epoch. Our Periods I B and C,

and Period II form an unbroken chain, and must be grouped around the middle of the epoch. The last burial group (Period 3) can be assigned to the end of the same epoch. The Levanto-Helladic Ware prevails and the presence of the treasures of gold, ivory and faience is characteristic of the time.

Tomb 11 A is a poor earth-tomb of still later date. It falls probably within the Late Cypriote III period.

TOMB 12 (Fig. 201: 1—5)

	SIZE			
	Length	Width	Depth	Height
Dromos	1.75	0.93	0.96	—
Stomion	0.15	0.58	—	0.74
Chamber	1.97	2.06	—	c. 0.95

SHAPE

The dromos is bath-shaped with one narrow, semicircular end; a straight front wall, and perpendicular sides. The floor is horizontal except for a small area in front of the stomion, where a shallow basin is cut to strengthen the door-packing. One chamber opens from the dromos. Its door-packing consisted of many stones, and was built up, so as to form a very solid structure. On a rectangular threshold block, wedged by small stones, stood a flat, semicircular grind stone, forming a vault. On top of the grinder were large, irregular stones which entirely filled the doorway. As the tomb was found by borings in the natural rock, and was entered from a hole knocked through its roof, the unusual packing could be studied *in situ*, also from inside. The floor of the chamber, the deepest point of which was in the centre, lay on a level about 0.30 m. below the dromos floor. Because of some faults in the natural rock, the floor has cracked, and a narrow fissure runs right across the chamber. The shape of the chamber is irregular. The left side wall is occupied by a long niche, raised about 0.40 m. above the floor. It forms a narrow shelf, and its floor slopes gently towards the wall of the chamber. The right side bulges out in a small recess at the level of the chamber floor, and the back wall shows a corresponding niche. The roof could be reconstructed as a low, curved vault of the usual type.

STRATIFICATION

About the stratification there is not much to be said. The dromos was filled by three layers of horizontally stratified *chavara*, and gave the impression of being perfectly intact. The bottom layer contained some ash and charcoal. The usual Byzantine building debris covered the dromos to a height of c. 1.20 m. A finely built wall was founded on the dromos-filling and a floor stratum started from the top of the second row of stones. In the chamber was a thin burial layer near the back wall and below the niche. It contained the remains

of a single skeleton, provided with two pots as burial gifts. The niche did not contain any human remains. Directly above this layer, lay a massive heap of rock debris fallen from the roof.

BURIALS

The body was lying on its back in a curved position with the trunk along the back wall, and the legs below the niche. It rested directly on the rock floor. The right arm was missing, and the left lay along its side. A bowl had been placed in the bosom, and a jug was found at its feet. This was the poorest of the chamber-tombs, found during the excavations.

FINDS (PL. LXXXI, 4)

1. Red-on-Black oval jug with flattened base; tapering neck; small, stilted rim, and handle from rim to shoulder. Bands of parallel, red lines on neck and body. Paint partly worn. Rim chipped. Height 24.3. Floor.
2. Fragments of a shallow, Red Polished IV bowl. Floor.

CHRONOLOGY

The two finds in the tomb both agree in assigning the tomb to Middle Cypriote III.

TOMB 13 (Figs. 200; 201:6—12; 202)

	SIZE			
	Length	Width	Depth	Height
Dromos A	0.93	0.69	0.67	—
Stomion A	0.14	0.42	—	0.44
Dromos B	1.75	0.88	1.21	—
Stomion B	0.15	0.44	—	0.53
Chamber A (reconstr.)	c. 1.90	2.27	—	c. 1.35
Total Chamber	3.50	2.27	—	c. 1.35
Dromos cupboard	0.47	0.53	—	0.41
Shaft Tomb 13 C	1.70	0.50	0.25	—

SHAPE

Tomb 13 is from a structural point of view, a fusion of two tombs, but has functioned as a single one. The complex has two dromoi: a small one in the S. end — Dromos A — and a larger one on the opposite side — Dromos B. Dromos A is an unusually small, oval shaft with rounded corners, perpendicular sides, and horizontal floor. From the S. end opens a small cupboard at the level of the floor. It is roughly oval with curved roof and flat floor, and was closed by a thin slab of local limestone, wedged by two smaller stones. The stomion of the chamber is of the same type. It is a very narrow, almost circular hole, blocked in the same way as the entrance of the cupboard. The floor of the chamber lies on a level about 1.00 m. lower than the dromos, and an abrupt step connects the two floors.

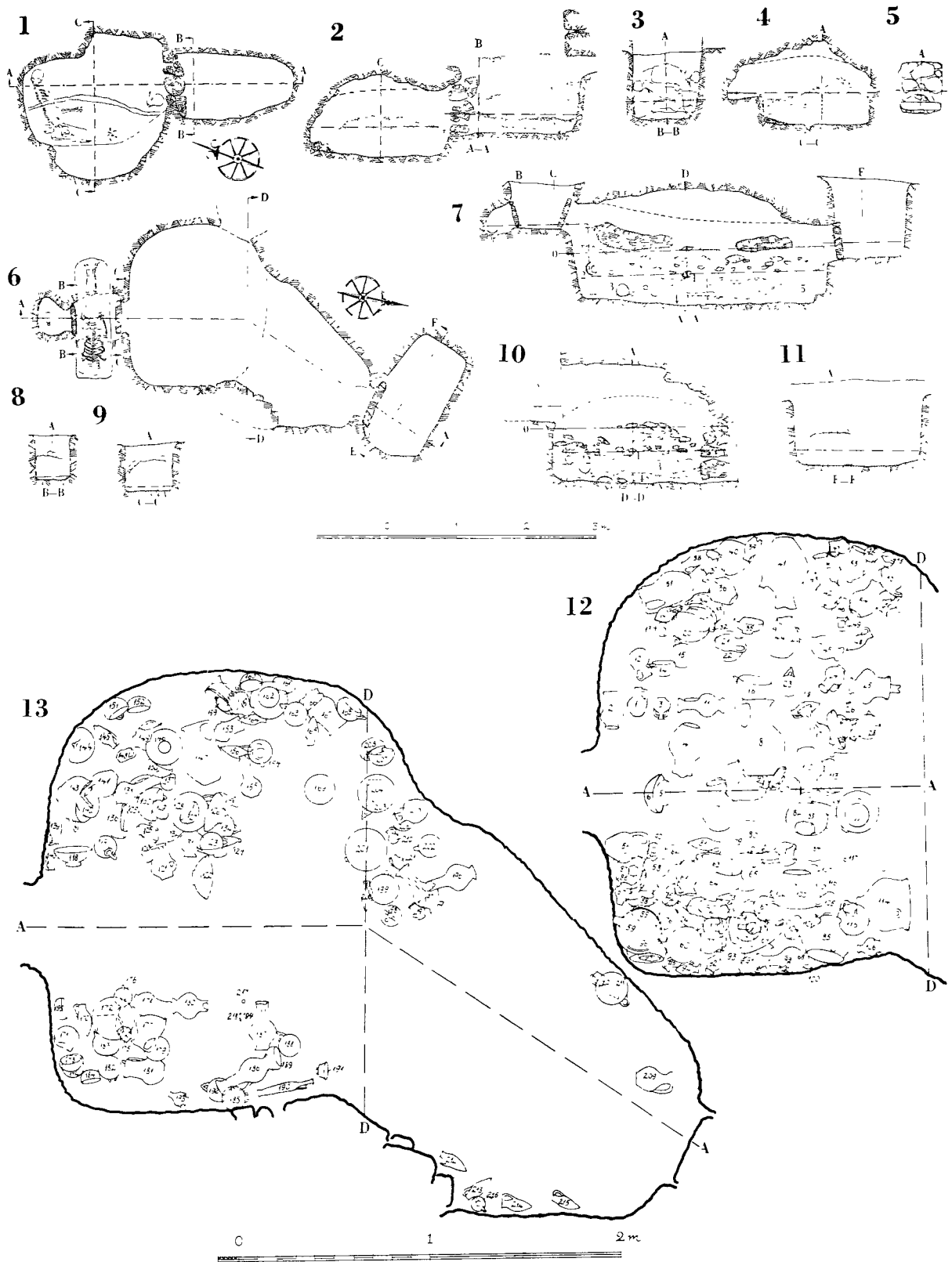

Fig. 201. Enkomi. Tomb 12, Plan (1); Sections A-A, B-B, C-C, (2, 3, 4); Inner face of door-packing (5). Tomb 13, Plan (6); Sections A-A, B-B, C-C, D-D, E-E (7, 8, 9, 10, 11); Finds *in situ*. (12, 13).

The original shape of the chamber — reconstructed as Chamber A — is not difficult to trace. Three of its sides are fairly intact, and indicate an original, circular shape. The floor is almost horizontal, the walls perpendicular up to a height of about 0.70 m. above the floor, where the flat vault of the roof starts.

This tomb has joined another one, the starting point of which is Dromos B. The dromos is an oblong shaft with rounded corners, flat bottom, and vertical sides. The chamber opens from the E. section of the S. long side, a very unusual and asymmetric arrangement, which probably had some special reason. The reason may have been the presence of another tomb in front of Dromos B, where the cutters had to avoid a collision by altering the direction of the chamber. The consequence was, however, that they struck upon the so-called Chamber A. Stomion B was closed by a solid block of heavy, calcareous stone, wedged in the usual way by small stones around the upper edge. The stomion leads by means of two steps down to the level of the floor, which lies about 0.65 m. below the dromos. The chamber is narrow close to the stomion, but widens gently southwards until it coincides with the so-called Chamber A. Near the left wall is built a substructure of roughly worked stones, in order to prevent the collapse of the roof. This substructure is applied just at the weakest point of the joint chamber, i. e., at the point of collision between the two original chambers.

As far as structural evidence goes, it seems undoubted that the older of the two joined chambers is that starting from Dromos A. Its regular shape seems original, in contrast with the other, the plan of which, apparently, depends on the difficult conditions of its cutting. The floor levels of the two tombs, however, coincide exactly, a fact that prevents one from drawing any certain conclusions. It is only a matter of secondary interest, which of the two tombs was the older, as they were used as a unit, and their stratification is coherent.

In the roof, just opposite the supporting wall, was a large hole, starting from a circular rock-cut well, which belongs to the Byzantine settlement above the tomb. The well has, evidently, been used for sanitary purposes. When the communication between tomb and well was established, is a matter of conjecture. It may have been purposely brought about by the cutters of the well, but it may also be the effect of the partial collapse of the roof (cf. below).

About 0.90 m. above the edge of Dromos A was an oblong, shallow shaft-tomb dug in the loose earth (Tomb 13 C). The end of the shaft was marked out by a curved grinding stone of the same type as that used in the door packing of Tomb 12 (see p. 525).

STRATIFICATION

The Byzantine settlement was in this section of the burial ground represented by a layer of mixed debris, about 1.10 m. thick, without distinct architectural remains. Below this layer followed a stratum, about 0.30 m. thick, of ordinary field earth, and thereafter the stratum from which Tomb 13 C was dug. The stratification, thus, showed features closely corresponding with those observed above Tombs 7, 10, and 11, and has to be interpreted in a similar way. We have, apparently, here too, to deal with a secondary burial in a shaft,

dug down into a tumulus on top of the original tomb. The layer from which Tomb 13 C started was, however, not of the usual curved shape, but slightly oblique. It sloped gently southwards, and continued gradually rising northwards, i. e., towards the chamber. That means that, if there was a tumulus, its apex was above the chamber. This hypothesis was corroborated by the stratigraphical observations above Dromos B, where the same layer was again found, now declining in the opposite direction.

Dromos A was filled to its rim by a homogeneous mass of *chavara*. This fact, however, does not exclude the possibility of repeated burials. It is a matter of course, that the dromos at such occasions must have been entirely emptied, because of its small dimensions. By an inadvertency, the stratification of Dromos B was not observed in detail, and therefore it cannot be stated if secondary burials had been carried out through its doorway, or not.

The chamber contained a considerable amount of extraneous earth, being debris from the roof, and earth flowed-in from the door-packings and the Byzantine well. Below these layers the stratification was as follows: —

- 1) A burial layer, confined mainly to the centre of the chamber and to the section close to Stomion A. The burial layer was silted and partly covered by a stratum of brown culture earth.
- 2) A thin layer of clay and wet *chavara*, forming a stratum of varying thickness and spread almost over the whole area.
- 3) A thick layer of silted clay, containing finds and burial remains.
- 4) A burial layer resting directly on the floor and of the same extent as Layer 3. It is partly silted and covered by a thin layer of dark brown, silted culture earth.
- 5) A large wedge-shaped layer of *chavara* mixed with grey, silted clay, which has flowed in through Stomion B. It rested directly on the floor, and reached up to the threshold of the doorway.

In spite of this seemingly distinct stratification, the chronological sequence of the finds is very uncertain. The levels of the different finds, given below in the Object Register, show that the objects were not found in clearly separated strata. The levels vary without traceable order between — 35 and floor. The reason is, of course, to be found in the wet and silted condition of the Layers 1—4, which have allowed finds and skeletal remains to float about in the chamber. If, thus, the contents of the tomb are not attributeable to certain burial periods, it is, on the other hand, fairly certain that there have been such periods. Layers 2 and 3 have probably once separated the two burial layers 1 and 4, and it seems presumable that Layer 2 was purposely spread, to serve as a bed for the burials represented by Layer 1. Another fact is clearly demonstrated by the stratification: the connection between the chamber and the Byzantine well was established after the unbroken layer of debris from the roof, covering Layer 1, had accumulated. Consequently, the Byzantine cutters have done no harm to the deposits.

The distribution of the finds in the chamber shows that the area close to the Stomion A — approximately the reconstructed Chamber A — has been much more frequently used, than the other section of the chamber. Layer 5, which reaches right down to the floor also indicates this.

BURIALS

No skeletal remains whatever, were well enough preserved to allow of any conclusions regarding the burial customs, or even a calculation of how many bodies had been deposited in the chamber.

FINDS (GROUPS: PLS. LXXXI, 12; LXXXV; TYPES: L. OF PL. II)

C h a m b e r

1. Black Slip Wheel-made oval jug with flat base; narrow, cylindrical neck; splaying rim, and handle from neck to shoulder. Height 15.5. — 36.
2. Black Lustrous Wheel-made squat jug with wide, cylindrical neck; small, flat rim; ridges around neck, and handle from rim to shoulder. Incomplete. Height 18.8. — 35.
3. Levanto-Helladic squat, rounded jug with base-ring; narrow neck; flattened rim, and two handles from neck to shoulder. Encircling lines around rim, neck, body, and base; a band of N-shaped ornaments around shoulder. Height 11.6. — 37.
4. Plain White Wheel-made oval jug with flat base; cylindrical neck; pinched mouth, and handle from rim to shoulder. Height 27.5. — 37.
5. Monochrome shallow bowl with flat base, and raised, in-turned rim. Handle missing. Diam. 12.1. Found in No. 6.
6. Plain White Wheel-made shallow bowl with base-ring; in-turned rim, and a string-hole projection at rim. Diam. 20.5. — 31.
7. Plain White Wheel-made jug, as No. 4. Height 25.0. — 36.
8. White Painted Wheel-made jug, as No. 4. A horizontal line around neck, and vertical strokes on body. Paint worn. Height 40.0. — 35.
9. Monochrome bowl, as No. 5; a wish-bone handle below rim. Diam. 11.7. Found in No. 10.
10. Base-ring I deep bowl with slightly in-turned, raised rim, and a curved wish-bone handle below rim. Rim chipped. Diam. 21.4. — 65.
11. Base-ring II oval jug with tall, cylindrical neck; flaring rim, a ridge below neck, and handle from neck to shoulder. Two incised, vertical lines on handle; bands of parallel, white lines around neck and body. Rim chipped; paint partly worn. Height 24.8. — 35.
12. Black Slip III oval jug with flattened base; wide, cylindrical neck; slightly pinched mouth, and handle from rim to shoulder. Paint worn. Height 15.7. — 35.
13. White Shaved bobbin-shaped bottle with pointed base; slightly tapering neck; pinched mouth, and handle from rim to shoulder. Height 16.7. — 35.
14. Monochrome bowl, as No. 9. Diam. 11.7. — 35.
15. Base-ring II deep, conical bowl with contracted, raised rim, and a high, curved wish-bone handle below rim. Diam. 12.1. — 35.
16. White Slip II hemispherical bowl with in-turned rim, and a triangular wish-bone handle below rim. Two bands of ladder-pattern, framing a dotted line, around rim; similar bands from rim to base, and transverse lines on handle. Paint much worn. Diam. 17.0. — 41.
17. Base-ring II jug, as No. 11. Height 25.3. — 42.
18. White Shaved bottle, as No. 13. Height 15.9. — 38.
19. White Shaved bottle, as No. 13. Piece of neck missing. Height 15.2. — 38.
20. White Slip II bowl, as No. 16. Decoration obliterated. Diam. 18.0. — 39.
21. Black Slip III jug, as No. 12. Paint obliterated. Height 15.7. Found in No. 22.
22. Base-ring II flat, conical bowl. Incomplete. Diam. 15.8. — 46.
23. Monochrome bowl, as No. 9. Diam. 11.8. — 52.
24. Base-ring II oval jug with cylindrical neck; splaying rim, and handle from neck to shoulder. A vertical, incised line on handle, and button-ornaments at base and top of handle. Height 16.2. — 56.
25. Base-ring I squat jug with wide, tapering neck; flat rim; handle from rim to shoulder, and a high, knobbed projection, pierced by a hole, at top of handle. Herring-bone patterns on projection, and at root of handle; straight and curved, incised rope-ornaments around neck and body. Rim chipped. Height 24.8. — 61.
26. Cylinder of white faience with gold mountings. On the cylinder is engraved a net-work pattern. Length 1.8. — 52.
27. Plain White Wheel-made shallow bowl with base-ring; indented rim, and a horizontal, cylindrical string-hole handle at rim. Diam. 13.5. — 55.
28. Plain White Wheel-made shallow bowl with flat base; plain rim, and two holes below rim. Diam. 12.4. — 55.
29. Plain White Wheel-made shallow bowl with base-ring, and flat in-turned rim. Incomplete. Diam. 21.1. — 57.

30. Base-ring II jug, as No. 11. An incised, vertical line on handle. Height 39.4. — 66.
31. Plain White Wheel-made jug, as No. 4. Pieces of rim missing. Height 27.7. — 44.
32. Plain White Wheel-made shallow bowl with base-ring, and plain rim. Rim chipped. Diam. 18.5. — 46.
33. Monochrome bowl with flat base; distinct, raised rim, and a wish-bone handle below rim. Diam. 16.4. — 44.
34. Monochrome bowl, as No. 9. Piece of handle missing. Diam. 12.8. Found in No. 33.
35. Base-ring I shallow bowl with raised, distinct rim, and a wish-bone handle below rim. Piece of handle missing. Rim chipped. Diam. 15.7. — 44.
36. Plain White Wheel-made oval jug with flat base; splaying neck; handle from neck to shoulder, and a ridge below neck. Height 19.5. — 40.
37. White Slip I squat jug with base-ring; wide, cylindrical neck; stilted rim, and an arched handle from rim to shoulder. Decoration obliterated, except for some oblique bands of parallel lines on handle, and vertical bands of ladder-pattern and lattice-lozenges below the handle. Height 13.7. — 54.
38. White Shaved bottle, as No. 13. Height 17.3. — 56.
39. White Shaved bottle, as No. 13. Base missing. Height 13.5. — 56.
40. Plain White Wheel-made jug, as No. 4. Neck and handle missing. Height 22.7. — 41.
41. Plain White Wheel-made jug, as No. 4. Rim and handle missing. Height 37.1. — 45.
42. Base-ring II squat, globular jug with tall, splaying neck; flaring rim; two ridges around neck; handle from neck to shoulder, and two curved relief-lines as front ornament. Height 28.0. Found in No. 43.
43. Plain White Wheel-made shallow bowl with base-ring, and plain rim. Rim chipped. Diam. 23.1. — 50.
44. Plain White Wheel-made jug, as No. 4. Neck and handle missing. Height 24.8. — 50.
45. Base-ring II jug, as No. 11. Height 15.4. — 50.
46. Monochrome bowl, as No. 5. Handle chipped. Diam. 10.3. — 61.
47. Base-ring I squat jug with wide, tapering neck; flat rim; handle from rim to shoulder, and a knobbed projection at top of handle. Two ridges around neck. Height 9.8. — 52.
48. White Shaved bottle, as No. 13. Height 15.6. — 57.
49. White Shaved bottle, as No. 13. Height 16.2. — 63.
50. Plain White Wheel-made bowl, as No. 27. Rim chipped. Diam. 16.2. — 63.
51. Base-ring I vase composed of two small, globular jugs with tall, tapering necks; funnel-rims, and two ridges around necks; a common handle from rim to shoulders. One of the jugs partly missing. Height 9.7. — 62.
52. White Shaved bottle, as No. 13. Neck and handle missing. Height 13.2. — 61.
53. Black Lustrous Wheel-made jug, as No. 2. Piece of rim missing. Height 17.9. — 65.
54. Plain White Wheel-made jug, as No. 4. Piece of body missing. Height 21.0. — 65.
55. White Shaved bottle, as No. 13. Height 15.1. — 50.
56. Plain White Wheel-made biconical jug with flat base; cylindrical neck; pinched mouth, and handle from rim to shoulder. Height 22.9. — 21.
57. Levanto-Helladic pear-shaped amphoriskos with raised base; low, concave neck, and three horizontal handles on shoulder. Decoration obliterated. Dark, slightly lustrous paint. Height 10.9. — 26.
58. Base-ring II jug, as No. 11. Height 27.1. — 26.
59. Plain White Wheel-made deep crater, with base-ring; wide, cylindrical neck; flat rim, and two handles from neck to shoulder. A ridge below neck. Height 20.2. — 35.
60. White Slip II bowl, as No. 16. Bands of ladder-pattern around rim, and from rim to base; dotted lines in their interstices. Handle missing. Diam. 19.1. — 21.
61. Plain White Wheel-made globular jug with flat base; concave neck; pinched mouth, and handle from rim to shoulder. Height 19.0. — 38.
62. Monochrome bowl, as No. 9. Diam. 10.6. — 38.
63. White Slip II bowl, as No. 16; decorated as No. 60. Diam. 18.6. Found in No. 64.
64. Plain White Wheel-made crater with base-ring, and out-turned rim; a horizontal handle on shoulder. Handle missing. Height 19.4. — 46.
65. Plain White Wheel-made shallow bowl with base-ring, and in-turned rim. Diam. 19.4. — 45.
66. Plain White Wheel-made jug, as No. 4. Height 20.4. Found on top of No. 67.
67. Plain White Wheel-made jug, as No. 61. Height 16.8. Found on top of No. 69.
68. Base-ring II jug, as No. 11. Height 25.8. — 51.
69. Plain White Wheel-made deep crater with base-ring; wide, cylindrical neck; slightly splaying rim; a ridge between neck and shoulder, and two handles from neck to shoulder. Pieces of rim, neck, and body missing. Height 25.4. — 47.
70. Base-ring II shallow, conical bowl with raised, in-turned rim, and a curved, horizontal handle below rim. White, concentric semicircles below rim, and encircling lines around base. Diam. 16.2. Found inside No. 69.
71. Base-ring II bowl, as No. 15. Diam. 14.2. Found inside No. 69.
72. Plain White Wheel-made shallow bowl, as No. 27. Incomplete. Diam. 21.8. Found on top of No. 73.
73. White Slip II bowl, as No. 16; decorated as No. 60. Diam. 17.9. — 51.
74. Red Slip Wheel-made oval jug with flat base; concave neck; a ridge below neck; pinched mouth, and handle from rim to shoulder. Rim chipped; paint worn. Height 17.5. — 51.
75. Monochrome bowl, as No. 9. Diam. 11.7. — 51.
76. Plain White Wheel-made bowl with flat base; curved sides, and a knobbed, horizontal handle below rim. Diam. 13.3. — 51.

77. Base-ring II jug, as No. 11. Height 23.8. — 45.
 78. Base-ring II jug, as No. 11. Height 27.7. — 50.
 79. White Slip II bowl, as No. 16. Decoration badly worn. Diam. 17.5. — 49.
 80. Monochrome bowl, as No. 5. Diam. 11.3. Found inside No. 79.
 81. White Shaved bottle, as No. 13. Height 16.7. — 61.
 82. Plain White Wheel-made crater with base-ring; splaying neck; thickened rim, and two handles from neck to body. Height 14.8. — 52.
 83. Monochrome bowl, as No. 5. Diam. 11.6. Found inside No. 82.
 84. Plain White Wheel-made bowl, as No. 27. Diam. 20.5. — 58.
 85. Plain White Wheel-made deep crater with base-ring; low, splaying rim; a ridge below rim, and two vertical handles on shoulder. Height 21.2. — 60.
 86. White Slip II bowl, as No. 16. Double bands of ladder-pattern around rim, and from rim to base; dotted, transverse lines on handle. Handle incomplete. Diam. 17.5. — 60.
 87. Plain White Wheel-made jug, as No. 4. Rim chipped. Height 21.7. Found inside No. 86.
 88. Plain White Wheel-made bowl, as No. 27. Diam. 18.4. Found on top of No. 89.
 89. Monochrome deep bowl, with flat base; biconical outline; high, in-turned rim, and a wish-bone handle below rim. Diam. 13.5. — 55.
 90. White Shaved bottle, as No. 13. Height 18.1. — 55.
 91. Plain White Wheel-made jug, as No. 4. Height 16.4. — 62.
 92. Levanto-Helladic amphoriskos, as No. 57. Spirals and tree-ornaments between handles. Paint worn; handles missing. Mat paint. Height 11.7. — 65.
 93. Base-ring II jug, as No. 11. Height 29.6. — 67.
 94. White Shaved bottle, as No. 13. Piece of handle missing. 13.0. — 60.
 95. Monochrome squat jug with round base; tall, narrow neck; pinched mouth, and handle from rim to shoulder. Height 9.0. — 52.
 96. Monochrome bowl, as No. 9. Diam. 18.5. — 54.
 97. Base-ring II bowl, as No. 15. Diam. 11.4. Found inside No. 96.
 98. Black Lustrous Wheel-made jug, as No. 2. Height 15.5. — 52.
 99. Black Slip Wheel-made oval jug with flat base; narrow, cylindrical neck; thick rim, and handle from neck to shoulder. Height 14.6. — 52.
 100. White Painted V oval jug with flat base; concave neck; handle from rim to shoulder, and a spout opposite the handle. Encircling lines around rim, neck, and spout; broad, vertical lines on spout, and from neck to base. Height 14.9. — 52.
 101. White Shaved bottle, as No. 13. Handle missing. Height 14.2. — 52.
 102. Plain White Wheel-made crater with base-ring; in-turned, flat rim; a ridge below rim, and two handles from rim to body. Height 19.4. — 55.
 103. Monochrome bowl, as No. 5. Diam. 11.1. Found inside No. 102.
 104. White Slip II shallow bowl with flattened base; plain rim, and a horizontal handle on rim. Bands of ladder-pattern around rim, and from rim to base; small lozenges below rim. Diam. 13.3. — 58.
 105. Plain White Wheel-made jug, as No. 4. Height 15.3. — 58.
 106. Levanto-Helladic amphoriskos, as No. 57. Decoration obliterated. Height 12.3. — 60.
 107. Monochrome bowl, as No. 5. Diam. 11.7. — 60.
 108. Plain White Wheel-made bowl with base-ring, and curved outline. Incomplete. Diam. 19.7. — 55.
 109. Levanto-Helladic very squat pyxis with flat base; rounded outline; splaying rim, and three horizontal handles on shoulder. Encircling lines round rim and base; nautilus-ornaments between the handles. Rim chipped; handle missing. Dark, lustrous paint. Diam. 13.3. — 68.
 110. Plain White Wheel-made jug with flat base; biconical body; cylindrical neck; thick rim; pinched mouth, and handle from rim to shoulder. Height 26.3. — 65.
 111. Levanto-Helladic shallow bowl with flat base; in-turned rim, and a string-hole handle on rim. Encircling lines outside and inside. Red, mat paint. Diam. 11.9. Found inside No. 112.
 112. Plain White Wheel-made plate with flat base; indented rim, and a horizontal, cylindrical string-hole handle at rim. Diam. 21.8. — 64.
 113. White Slip II bowl, as No. 16, but with dotted lines as front ornament, and a chain of hooked loops below rim. Handle incomplete. Diam. 18.1. — 66.
 114. Levanto-Helladic deep crater with base-ring; in-turned sides; flat rim, and two horizontal handles on body. Encircling lines around rim, body, and base; a frieze of birds between the handles. Red, mat paint. Height 25.5. — 68.
 115. Plain White Wheel-made jug, as No. 4. Height 27.9. — 70.
 116. Flat rectangular bead of multi-coloured glass-paste, pierced by a hole in the longitudinal axis, and mounted with a gold band round the edges, and two rings round the holes. Length 1.9. — 57.
 117. Oval, fluted gold bead. Length 1.0. — 62.
 118. Plain White Wheel-made bowl, as No. 108. Diam. 19.4. — 51.
 119. Levanto-Helladic squat jug with raised base; concave neck, and handle from rim to shoulder. Encircling lines around rim, neck, body, and base. Dark, lustrous paint; worn. Height 10.7. — 51.
 120. White Shaved bottle, as No. 13. Rim chipped; handle missing. Height 14.9. Found on top of No. 121.
 121. Black Lustrous Wheel-made jug, as No. 2. Incomplete. Height 17.5. — 65.
 122. Plain White Wheel-made bowl, as No. 108. Diam. 23.0. Floor.

123. Monochrome bowl, as No. 9. Diam. 11.4. Found inside No. 124.
124. Plain White Wheel-made shallow bowl with base-ring; in-turned rim, and a horizontal, cylindrical string-hole handle at rim. Diam. 22.5. — 60.
125. Plain White Wheel-made shallow bowl with base-ring; indented rim, and a string-hole handle at rim. Diam. 13.5. — 62.
126. Plain White Wheel-made bowl, as No. 27. Rim chipped. Diam. 21.8. Found on top of No. 133.
127. Monochrome bowl, as No. 9. Handle missing. Diam. 11.6. Found inside No. 128.
128. Plain White Wheel-made bowl, as No. 108. Diam. 20.4. Found on top of No. 131.
129. Monochrome bowl, as No. 5. Diam. 11.6. Found inside No. 130.
130. White Slip II bowl, as No. 16. Bands of ladder-pattern around rim, and from rim to base; small lozenges below rim, and transverse lines on handle. Diam. 18.0. — 55.
131. Base-ring II jug, as No. 42. Height 27.7. Floor.
132. White Shaved bottle, as No. 13. Height 16.3. Floor.
133. Base-ring II jug, as No. 42, but with two vertical relief-lines as front ornament. Pieces of body missing. Height 27.3. Floor.
134. Monochrome bowl, as No. 9. Diam. 13.3. Floor.
135. Plain White Wheel-made bowl, as No. 108. Diam. 19.2. Found inside No. 136.
136. White Slip II bowl, as No. 16. Bands of ladder-pattern around rim, and from rim to base; a dotted line on rim, and transverse lines on handle. Height 17.4. Floor.
137. White Shaved bottle, as No. 13. Height 15.6. — 61.
138. Base-ring II jug, as No. 42; decorated as No. 133. Height 26.9. — 64.
139. White Shaved bottle, as No. 13. Height 18.7. — 60.
140. White Shaved bottle, as No. 13. Height 15.4. — 61.
141. Plain White Wheel-made jug, as No. 4. Height 22.3. — 61.
142. Plain White Wheel-made bowl, as No. 108. Diam. 17.0. Found inside No. 143.
143. Base-ring I bowl, as No. 10. Diam. 22.4. — 51.
144. White Slip II bowl, as No. 16. Double bands of ladder-pattern around rim, and from rim to base; a dotted line on rim; a band of lozenges below rim, and two vertical bands of lozenges as front ornament. Diam. 17.4. — 55.
145. White Shaved bottle, as No. 13. Height 16.0. — 55.
146. Plain White Wheel-made bowl, as No. 108. Diam. 11.2. Found on top of No. 149.
147. Plain White Wheel-made jug, as No. 4. Height 32.0. — 57.
148. White Painted V rattle, in the shape of a miniature jug with flat base; top in the shape of an owl's head; a handle from top to body. Encircling lines round top; vertical lines on body, and a framed zigzag line as front ornament. Height 8.2. — 61.
149. Base-ring I squat jug with biconical body; wide, concave neck; flat rim; handle from rim to body, and a projection at top of handle. Incised hatchings on the projection; two ridges around neck, and a wavy relief-line on shoulder. Projection incomplete. Height 15.7. — 58.
150. Monochrome bowl, as No. 9. Diam. 12.6. — 60.
151. Monochrome bowl, as No. 9. Diam. 12.6. — 60.
152. Monochrome bowl, as No. 9. Handle missing. Diam. 12.2. — 60.
153. Black Lustrous Wheel-made jug, as No. 2. Height 16.2. — 60.
154. Plain White Wheel-made squat jug with flat base; wide, concave neck; pinched mouth, and handle from rim to shoulder. Height 12.5. Floor.
155. Base-ring II squat jug with tall, cylindrical neck; splaying rim; high, pinched mouth; two ridges around neck, and handle from neck to shoulder. Height 22.7. Floor.
156. White Shaved bottle, as No. 13. Incomplete. Height 16.2. — 62.
157. Base-ring II jug, as No. 11. Piece of handle missing. Height 26.0. Found on top of No. 158.
158. White Slip II bowl, as No. 16. Horizontal and wavy lines around rim; vertical lines from rim to base, and transverse lines on handle. Diam. 19.1. — 58.
159. Monochrome bowl, as No. 9. Handle incomplete. Diam. 9.7. Found inside No. 158.
160. Monochrome bowl, as No. 9. Diam. 11.4. — 58.
161. Monochrome bowl, as No. 9. Handle missing. Diam. 12.4. — 60.
162. Bichrome Wheel-made oval jug with base-ring; concave, tapering neck; flat, splaying rim, and handle from rim to shoulder. Bichrome encircling lines around rim, neck, and body; a band of latticed triangles below rim; a chain of loops, encircling wheel-ornaments around neck; groups of oblique, parallel lines on shoulder. Paint slightly worn. Height 31.4. Floor.
163. Monochrome bowl, as No. 9. Diam. 12.3. Found on top of No. 162.
164. White Shaved bottle, as No. 13. Height 15.4. Floor.
165. White Shaved bottle, as No. 13. Height 15.5. Floor.
166. The base-ring of a Plain White Wheel-made crater. Diam. 14.0. Found on top of No. 167.
167. White Painted V squat jug with flat base; wide, cylindrical neck; handle from rim to body, and a projection on top of handle. Incomplete. Height 19.1. Floor.
168. Monochrome bowl, as No. 5. Diam. 12.3. Floor.
169. Plain White Hand-made shallow bowl with base-ring. No handle. Diam. 14.8. Floor.
170. White Shaved bottle, as No. 13. Height 17.7. — 48.
171. Trefoil-shaped lamp of terracotta with round base, and pinched mouth. Piece of nozzle missing. Diam. 13.3. — 59.
172. Plain White Wheel-made bowl, as No. 108. Diam. 22.0. Found on top of No. 183.
173. Monochrome bowl with flat base, and out-turned,

- indented rim. Handle missing. Diam. 11.8. Found inside No. 174.
174. Monochrome bowl, as No. 9. Handle missing. Diam. 11.5. Floor.
175. Levanto-Helladic squat pyxis with angular outline; flat base; concave neck, and three horizontal handles on shoulder. Encircling lines around rim, neck, and body; concentric circles on base, and vertical strokes between handles. Red, mat paint; worn. Diam. 8.5. — 55.
176. White Painted V globular jug with flattened base; wide, cylindrical neck; handle from rim to shoulder, and a spout opposite the handle. Encircling lines around rim, neck, and body; vertical bands of parallel lines from neck to belly, and from belly to base. Height 10.9. — 55.
177. Plain White Wheel-made jug, as No. 4. Height 20.9. Found on top of No. 179.
178. Black Lustrous Wheel-made jug, as No. 2. Height 18.8. Floor.
179. Monochrome bowl, as No. 9. Handle missing. Height 11.8. Floor.
180. Base-ring II jug, as No. 11. Neck and handle missing. Height 29.5. — 48.
181. White Painted V jug, as No. 167. Encircling lines round rim, neck, and body; lattice-lozenges around neck; oblique bands of parallel lines from neck to belly, and vertical lines from belly to base. Incomplete; paint worn. Height 22.5. Floor.
182. Monochrome bowl, as No. 173. Handle incomplete. Diam. 12.2. Floor.
183. White Painted V jug, as No. 167, but with round base, and a small projection opposite the handle. Decoration obliterated. Height 24.7. Floor.
184. Monochrome bowl, as No. 173. Handle incomplete. Diam. 10.4. Floor.
185. Monochrome bowl, as No. 9. Handle incomplete. Diam. 12.0. Floor.
186. Base-ring II jug, as No. 11. Height 29.9. Floor.
187. Base-ring II jug, as No. 11. Rim missing. Height 25.3. Floor.
188. Monochrome bowl, as No. 9. Diam. 11.6. Floor.
189. Monochrome bowl, as No. 9. Diam. 11.6. Floor.
190. Red Lustrous Wheel-made tall bottle with tall, tapering neck; wide, flat rim; base-ring, and handle from neck to shoulder. Height 28.7. Floor.
191. Levanto-Helladic low cup with raised base; concave sides, and handle from rim to body. Encircling lines outside and inside. Red, mat paint. Diam. 8.7. Floor.
192. Monochrome bowl, as No. 9. Diam. 12.0. Floor.
193. Levanto-Helladic amphoriskos, as No. 57. Encircling lines around rim, neck, body, and base; spirals and tree-ornaments between the handles. Red, mat paint; worn. Height 10.5. Floor.
194. Two oval gold beads; much embossed. Floor.
195. Monochrome bowl, as No. 173. Handle missing. Diam. 11.4. Floor.
196. Base-ring II jug, as No. 42. Height 26.7. Found on top of No. 197.
197. Base-ring II jug, as No. 42. Rim and base-ring chipped. Height 28.6. — 52.
198. Levanto-Helladic squat, rounded stirrup-vase with base-ring. Encircling lines around rim, neck, and body; a dot on the knob. Dark, lustrous paint. Height 9.3. Floor.
199. Base-ring II bowl, as No. 70, but without decoration. Rim chipped. Diam. 15.2. Floor.
200. White Shaved bottle, as No. 13. Height 16.0. Floor.
201. Plain White Wheel-made bowl, as No. 27. Diam. 21.8. Floor.
202. Levanto-Helladic shallow bowl with base-ring; curved outline, and handle from rim to body. Encircling lines around rim and base; a band of spirals around body. Red, lustrous paint. Diam. 11.9. Floor.
203. White Slip II bowl, as No. 16; decorated as No. 60. Diam. 19.3. Found on top of No. 204.
204. Levanto-Helladic amphoriskos, as No. 57. Encircling lines around rim, neck, body, and base; a band of N-shaped ornaments between handles. Dark, slightly lustrous paint; worn. Height 12.0. — 64.
205. Plain White Wheel-made jug, as No. 4. Piece of handle missing. Height 17.6. Found on top of No. 206.
206. Levanto-Helladic bowl, as No. 202. Encircling lines around rim and base, and chevrons around body. Diam. 12.7. — 60.
207. Monochrome bowl, as No. 9. Incomplete. Diam. 12.7. Found inside No. 208.
208. Monochrome bowl, as No. 9. Diam. 12.0. — 50.
209. Plain White Wheel-made jug, as No. 4. Height 18.9. + 7.
210. Plain White Hand-made globular jug with cylindrical neck, and handle from rim to shoulder. Height 8.0. Floor.
211. Levanto-Helladic shallow bowl with base-ring; rounded outline, and a horizontal handle below rim. Encircling lines outside and inside; an encircled spiral on bottom. Mat, red paint. Diam. 15.9. — 51.
212. White Shaved bottle, as No. 13. Piece of handle missing. Height 16.1. Floor.
213. White Shaved bottle, as No. 13. Height 17.5. — 62.
214. White Shaved bottle, as No. 13. Height 16.4. — 62.
215. White Shaved bottle, as No. 13. Height 14.9. — 62.
216. White Painted V jug, as No. 100. Decoration almost obliterated. Height 9.7. Floor.
217. Small circular earring of gold, decorated with alternating plain and twisted gold wire. Diam. 1.2. Floor.
218. Shallow bowl of faience with base-ring, and indented rim. The bowl is decorated with alternating white and yellow oblong pentagons, arranged like a ring of petals around the bowl; the edge is coloured black, and the interior light yellow. Some pieces missing; rim chipped. Diam. 10.8. Floor.

pottery indicate that the tomb ceased to be in use before the middle of Late Cypriote II. It is uncertain if the original bottom layer represents purely Late Cypriote I or if it ought to be assigned to the beginning of Late Cypriote II, but the frequency of Middle Cypriote wares points to the former date.

TOMB 14 (Figs. 203; 204: 1—2)

SIZE

Length	Width	Depth
2.35	c. 1.90	1.05

SHAPE

The tomb is a shaft tomb of much the same type as Tomb 5 (see above p. 490), but of a much ruder workmanship. It is a roughly square shaft, dug through the earth down to the natural rock. Its sides have been faced with coarse masonry which, however, was only fragmentarily preserved. Some of the blocks on the E. side were large, upright slabs, but the rest were crude stones of small dimensions. The floor was partly paved with small stones.

STRATIFICATION

The shaft was filled with three layers of earth, mixed with gravel in approximately horizontal strata. Thereafter followed the burial stratum, containing three skeletons and their tomb-gifts, which all rested on a floor stratum of hard-packed *chavara* and stones. The Byzantine layers above the edge of the tomb had only a total depth of c. 0.60 m. and contained nothing of great interest.

BURIALS

The three burials in the tomb date from the same time, and the skeletons were rather well preserved. One female skeleton was lying in an outstretched dorsal position with the head towards the N. wall of the shaft. With their heads resting on the femora of the first skeleton were two children's skeletons in a similar position, but lying in an East and West direction. The tomb-gifts were placed around the head and upper part of body of the first skeleton. It had, too, around the neck the remains of a necklace of gold and faience beads (No. 8).

FINDS (GROUPS: PL. LXXXI, 10, 11; TYPES: L. OF PL. II)

- | | |
|--|--|
| 1. Fragments of a shallow bronze bowl with round base, and stilted rim. Floor. | 4. Wheel-made Bucchero jug with base-ring; oval body; cylindrical neck; splaying rim; a ridge below neck, and handle from rim to shoulder. Fluted body. Height 18.4. Floor. |
| 2. Plain White Wheel-made oval jug with base-ring; concave, narrow neck; a ridge below neck; splaying rim, and handle from neck to shoulder. Height 29.9. Floor. | 5. Hand-made Bucchero jug, with base-ring; oval body; tall, tapering neck; splaying rim; a ridge below neck, and handle from rim to shoulder. Fluted body. Height 18.7. Floor. |
| 3. Flat bowl of steatite with base-ring, and flat rim; a conical pestle of the same material. Diam. of bowl 15.6. Length of pestle 7.6. Floor. | |



Fig. 202. Enkomi. Tomb 13. Interior view with finds *in situ*.



Fig. 203. Enkomi. Tomb 14 with finds and skeletons *in situ*.

6. Hand-made Bucchero jug, as No. 5, but with indented rim. Height 22.4. Floor.
7. Bone tool made of a rib, and probably used for polishing pottery. Length 13.2. Floor.
8. Small chain composed of eight gold, two carnelian and

fourteen paste beads; a central pendant of ivory mounted in gold and silver. The composition is made certain, thanks to the position of the beads in the tomb. Length 8.4. Floor.

A Summary of the Object Register follows in the diagram below: - -

P o t t e r y			B r o n z e	G o l d and F a i e n c e	S t o n e		B o n e
Hand-made	Wheel-made				Bowl	Pestle	
Bucchero	Bucchero	Pl. Wh.	Bowl	Necklace	Bowl	Pestle	Tool
5. 6	4	2	1	8	3	3	7
-2	-1	-1	-1	-1	-1	-1	-1

CHRONOLOGY

The Bucchero Ware and the advanced shaped of the Plain White Wheel-made pots assign the tomb to Late Cypriote III.

TOMB 15 (Fig. 204: 3; 205)

S I Z E		
Length	Width	Depth
1.82	0.65	c. 0.40

SHAPE

This tomb is an oblong, shallow shaft dug in the earth. It was not marked in any noticeable way and, consequently, very much resembled Tombs 7 A and 11 A. There was, however, no rock-cut tomb beneath, and the bottom of the shaft lay c. 0.35 m. above the surface of the natural rock. The shaft tapered towards the feet of the body.

STRATIFICATION

The shaft contained a hard bottom layer of sand and gravel on which a burial stratum, containing skeletal remains and tomb-gifts, rested. Above this was a layer of sandy earth and some stones, filling the shaft to the edge. The edge of the shaft marked the surface level at the time of the burial, and above this had accumulated a layer of mixed earth about 0.30 m. thick. The Byzantine debris above the tomb had a thickness of c. 0.85 m. and did not offer any features of great interest. It consisted mainly of the typical, red earth, emanating from decomposed mud-bricks. Some fragments of coarse tiles were found in the layer. Between the rock and the edge of the shaft, was some horizontally stratified field-earth containing a few Late Cypriote potsherds.

BURIAL

A single burial had taken place in the shaft; evidently female skeleton, she was lying in an outstretched dorsal position with the left hand on her bosom. The right arm was missing. Three pots and a fine ivory box surrounded the body.

FINDS (GROUP: PL. LXXXI, 5, 6)

- | | |
|--|--|
| <p>1. Wheel-made Bucchero oval jug, with base-ring; tall, tapering neck; a ridge below neck, and handle from rim to shoulder. Fluted body. Height 16.0. Floor.</p> <p>2. Hand-made Bucchero jug, mainly as No. 1, but with cylindrical neck, and indented rim. Height 15.0. Floor.</p> <p>3. Hand-made Bucchero jug, as No. 2. Height 19.4. Floor.</p> | <p>4. Cylindrical ivory box, with projecting string-hole handles at base; a button-shaped lid with a hole in the centre, and two holes at base. The lid is decorated with incised, encircling lines and semicircles; the body is covered with bands of scale-pattern; an encircled flower-ornament on the base. Height 11.0. Diam. 3.8. Floor.</p> |
|--|--|

Summing up the Object Register we get the following diagram: —

P o t t e r y		Ivory
Hand-made	Wheel-made	Box
Bucchero	Bucchero	
2, 3	1	4
-2	-1	-1

CHRONOLOGY

The tomb is contemporary with the other earth tombs, and ought to be assigned to Late Cypriote III. The Bucchero Ware is a safe indication of this date.

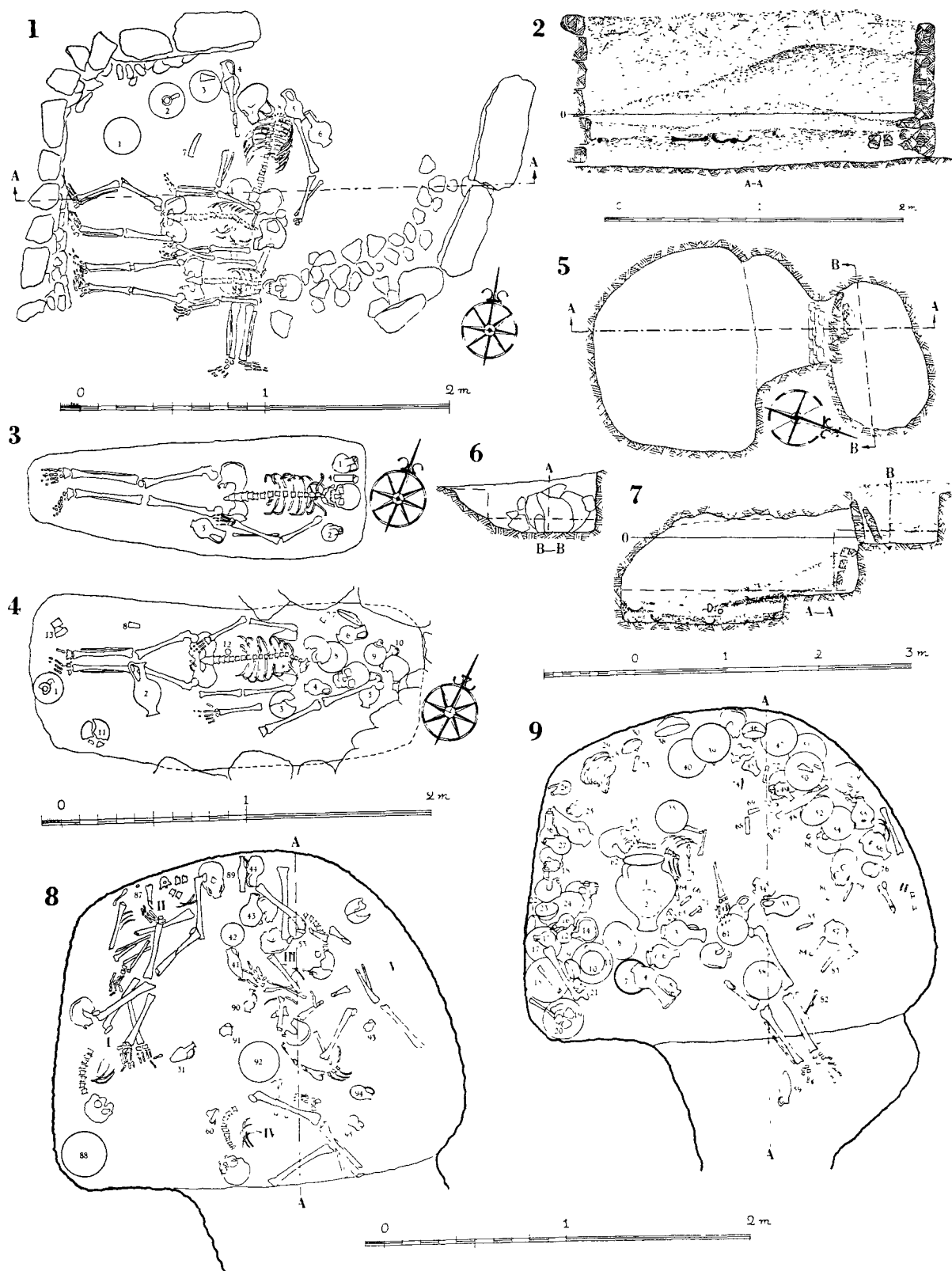

Fig. 204. Enkomi. Tomb 14, Plan (1); Section A-A (2). Tomb 15 (3). Tomb 16 (4). Tomb 17, Plan (5); Sections B-B, A-A (6, 7); Finds in situ, lower layer (8); upper layers (9).

TOMB 16 (Fig. 204: 4)

SIZE		
Length	Width	Depth
2.13	0.87	c. 0.50

SHAPE AND STRATIFICATION

Close to Tomb 15 was found another tomb of much the same shape. It was also an oblong shaft, dug in the earth, but of slightly larger size. It had to be excavated partly by means of a tunnel as it was entirely built over by a Byzantine house. All the stones, surrounding the shaft on the plan (Fig. 204: 4) belong to this building. The rest of the stratification corresponds exactly with that observed in Tomb 15.

BURIALS

Two burials had taken place in the shaft. One was still *in situ*, lying in a dorsal, outstretched position with both hands resting on the bosom. The skull, right leg, left hand, and left cubital bone of an earlier skeleton was found in a heap, close to the head of the later body. Among the tomb-gifts of the later burial, the ivory comb No. 13 is worth noticing.

FINDS (GROUP: PL. LXXXVI, 1, 2; TYPES: L. OF PL. II)

- | | |
|--|---|
| <p>1. Plain White Wheel-made oval jug with curved base-ring; conical neck; wide, collar-shaped mouth, and a curved handle from rim to shoulder. Rim chipped. Height 32.7. Floor.</p> <p>2. Plain White Wheel-made jug, as No. 1. Height 30.4. Floor.</p> <p>3. Fragments of a shallow bronze bowl with round base, and stilted rim. Floor.</p> <p>4. Hand-made Bucchero oval jug with base-ring; cylindrical neck; a ridge below neck; splaying rim, and handle from rim to shoulder. Fluted body. Rim chipped; surface worn. Height 14.1. Floor.</p> <p>5. Hand-made Bucchero jug, as No. 4. Height 19.7. Floor.</p> <p>6. Hand-made Bucchero jug, as No. 4. Height 16.5. Floor.</p> <p>7. Shallow bowl of white calcareous stone with base-ring, and in-turned rim. A pestle in the shape of a truncated</p> | <p>cone of the same material. Diam. of bowl 15.4. Length of pestle 6.4. Floor.</p> <p>8. Bowl and pestle, as No. 7. Rim chipped. Diam. of bowl 16.7. Length of pestle 6.3. Floor.</p> <p>9. Plain White Wheel-made globular jug with base-ring; short, tapering neck; a ridge below neck; splaying rim, and handle from rim to shoulder. Height 16.5. Floor.</p> <p>10. Hand-made Bucchero jug, as No. 4. Height 13.3. Floor.</p> <p>11. Fragments of a bronze bowl, as No. 3. Floor.</p> <p>12. Plain, circular ivory button, pierced by a hole in the centre. Chipped. Diam. 3.3. Floor.</p> <p>13. Flat ivory comb with teeth on both sides. The front is decorated with an incised pattern of framed bands of plaited ribbons and zigzag lines; the back is plain, except for two framed zigzag bands. Worn and damaged. Length 8.8. Floor.</p> |
|--|---|

A summary of the Object Register gives the following diagram: —

P o t t e r y		B r o n z e	S t o n e		I v o r y	
Hand-made	Wheel-made		Bowls	Pestles	Button	Comb
Bucchero	Pl. Wh.					
4. 5. 6. 10	1, 2, 9	3. 11	7. 8	7. 8	12	13
-4	-3	-2	-2	-2	-1	-1

CHRONOLOGY

The type and contents of the tomb correspond closely to Tombs 14 and 15, and it is contemporary with these. It ought to be assigned to Late Cypriote III.

TOMB 17 (Figs. 204: 5—9; 206)

SIZE

	Length	Width	Depth	Height
Dromos	1.65	0.98	0.56	—
Stomion	0.26	0.67	—	0.41
Chamber	2.36	2.22	—	1.13

SHAPE

The dromos of this tomb is an oblong, oval shaft with rounded corners, vertical long sides, and one perpendicular short side. The floor slopes gently from the south side down to the entrance of the chamber, which opens from the end of the western long side. The stomion was carefully blocked by three flat slabs and several small stones, which were all found *in situ*. The asymmetrical arrangement of dromos and stomion resembles much the disposition of Dromos B in Tomb 13. The stomion leads down by means of a vertical step to a niche which is raised 0.30 m. above the level of the chamber floor. The difference in level between the threshold of the doorway and the floor of the niche is about 0.55 m. This step is built of roughly worked, flat stones. The shape of the chamber itself is almost trapezoid with rounded corners and somewhat curved sides. The floor is horizontal, the walls perpendicular to a height of 0.50 m., and the roof curved so as to form a flat vault.

STRATIFICATION

The Byzantine layers above the tomb were very massive, and reached a total depth of about 1.10 m. Above the stomion of the tomb was a solid wall of dressed masonry, resting on a layer of rough stones and plaster.

In the dromos, the filling consisted of two horizontally stratified layers of *chavara*. The tomb was intact, when found, and if repeated burials have taken place in the chamber, the whole dromos must have been excavated and refilled in connection with these secondary burials.

The small size of the chamber, and the solid structure of the rock have prevented any serious, sudden falls of roof and walls. The door-packing being very solid, practically no extraneous earth was found in the chamber. A thin layer of *chavara* debris covered the central area of the tomb, and an oblique stratum of silted clay had flowed in from the door, and covered the niche. On a level with the niche and partly resting on it, lay a burial stratum, separated from the bottom stratum by a thin layer of silted *chavara*. The bottom layer consisted of a thick burial stratum, containing much mouldered skeletal remains, and finds of different kinds. It was silted and very wet, when excavated. Consequently, the differences in levels between the finds cannot in all cases be considered as indications of the relative chronology of the objects. A critical examination of the position of the finds, especially their connections with the skeletal material, can, however, lead to a result. Starting our investigation from the upper burial layer, we can state that the latest burial in the



Fig. 205. Enkomi. Tomb 15. Finds and skeleton *in situ*.



Fig. 206. Enkomi. Tomb 17. Finds of the upper layer *in situ*.

chamber is represented by a skeleton, lying with its feet on the niche, and with the rest of the body on the same level, resting on the above-mentioned layer of silted *chavara*. Belonging with certainty to this body is a gold bowl (No. 61) which was held in the right hand. Further we have a silver pin (No. 78); a diadem (No. 62), and a mouth-piece (No. 63) which evidently belong to its personal equipment. Partly resting on the left femur, was a bowl (No. 58). Close to the head of the dead body was an amphora (No. 1) with a bowl (No. 2) inside, and at its feet a bottle (No. 59).

Directly on the floor lay remains of five skeletons, some apparently *in situ*. Of the contents of the chamber, some burial gifts were attributable to these bodies, i. e., Nos. 31, 41—44, 53, 60, and 87—95. They were found on the floor. The gold and silver objects Nos. 78 and 83—86 were, also, found on the floor, but as they can easily have sunk through the silted layers down to their present level, it seems safer not to make any certain attribution. This being so, about 25 % of the tomb-gifts are placed in their respective groups. Of the rest, of course, some might have belonged to either of the two groups, but it seems reasonable to presume that the majority of them may be ascribed to an intermediate period. That such a period must have existed, is demonstrated by the considerable thickness of the burial layer and by skeletal remains of six bodies found near the walls of the chamber on an intermediate level.

The three groups thus established form a chronological sequence, but it must be borne in mind that the range of the intermediate group is not fixed.

BURIALS

The skeletal material of the bottom layer was fairly well preserved. It comprised five bodies: two along the left wall (I and II); two in the central area (III and IV) and one very fragmentary, near the right wall (V). The legs of No. I were sharply bent at the knees, and the tibiae were partly covered by the femora. The remains of the spinal column were

slightly bent. The skull was lying not far from the lower vertebrae. This position shows that the body has been deposited sitting with crooked legs.

No. II was found in a similar position. Its legs were bent; the spinal column was found in a heap close to the wall; the bones of the arms were found near the femora, and the head was lying upside down. Here, too, the dead body was placed in a sitting position, and the gradual decomposition of the corpse has brought the bones to their present positions. Skeletons III and IV can also be reconstructed with satisfactory certainty. The plan (Fig. 204:8) speaks for itself. The curved spinal columns, especially, and the crossed femora illustrate the original positions. Thus all these four bodies had been buried according to the old Cypriote custom in sitting positions. Of Skeleton V as well as the six skeletons in the intermediate layer, too little remained to allow of any certain conclusions. The last body brought into the chamber was deposited in a dorsal, outstretched position with its feet towards the entrance upon the niche.

FINDS (GROUPS: PLS. LXXXVI, 3; LXXXVII, I, 2; TYPES: L. OF PL. II)

1. Levanto-Helladic pear-shaped amphora with high, raised base; wide, cylindrical neck; flat rim, and two handles from rim to shoulder. The chief decorative elements are two fairly realistic octopuses, covering the body of the vase from neck to base between the handles. The bodies of the octopuses are sack-shaped with a contraction in the middle, and are entirely covered with white dots. At the top of the bodies are two circular eyes, and the heads are surmounted by short, radiating lines. From each side of the heads four long, wavy arms project, dotted like the bodies. The arms move freely in the water, which is indicated by sea weed, and a wavy line with short, vertical stripes running horizontally between the handles of the vase. Below the handles the scene changes: below the one, are two flying birds, and below the other, facing right, is a chariot drawn by one horse, and containing two persons in right profile. Chariot and charioteers are all dotted with dark dots on white ground, the horse with white dots on dark ground. Before the chariot stands a man with a balance in his hand. He is painted in the same way as the charioteers, and is dressed in a wide gown reaching to his feet; he faces the advancing chariot. Below the horse, is another man walking to the left: he is a slender figure drawn entirely in dark colour with white dots, except for the face, which is left white. He carries with both hands a curious object shaped like an hour-glass.² Rim of vase is decorated with herring-bone pattern, and short, transverse lines; handles with framed, transverse lines. The decoration is done with much skill and artistic grace. Height 37.5. — 55.
2. Base-ring II conical bowl with concave, angular outline; raised rim, and a curved wish-bone handle below rim. Diam. 15.1. Found inside No. 1.
3. Base-ring II oval jug with high, curved base-ring; a ridge between neck and shoulder; tall, concave neck; flaring rim, and handle from neck to shoulder. White, horizontal lines around neck, and crossed, oblique lines on body. Height 22.7. — 58.
4. Base-ring II squat, globular jug with tall, splaying neck; flaring rim, and handle from neck to shoulder. Ridges around neck, and curved relief-lines as front ornament. Height 27.4. Found on top of No. 7.
5. White Shaved bobbin-shaped bottle with pointed base; concave neck; splaying rim; pinched mouth, and handle from rim to shoulder. Height 15.7. — 60.
6. Levanto-Helladic pear-shaped amphoriskos with raised, narrow base; wide, concave neck; flaring rim, and three horizontal handles, symmetrically arranged on shoulder. Encircling lines around rim, neck, shoulder, body, and base; red handles, and a panel-pattern of vertical lines, alternating with small chevrons, between handles. Height 16.7. — 58.
7. Plain White Wheel-made shallow bowl with base-ring, and rim thickening inwards. Diam. 19.0. — 65.
8. Plain White Wheel-made bowl, as No. 7. Diam. 21.1. — 69.
9. Monochrome conical bowl with flat base; raised, somewhat in-turned rim, and a horizontal wish-bone handle below rim. Handle chipped. Diam. 10.3. Found on top of No. 11.
10. Monochrome bowl, as No. 9. Diam. 13.2. Found inside No. 11.
11. Monochrome bowl, mainly as No. 9. Handle missing. Large size. Diam. 22.3. — 77.
12. Black Slip II oval jug with flattened base; convex, tapering neck; splaying rim, and raised handle from rim to shoulder. Paint obliterated; surface worn. Height 11.5. — 61.
13. Black Lustrous Wheel-made oval jug with flattened base, and narrow neck. Upper part of neck and handle missing. Height 12.5. Found on top of No. 17.

14. Trefoil-shaped, open lamp of terracotta with raised base; thickened rim, and deeply pinched mouth. Diam. 14.0. — 65.
15. Plain White Wheel-made bowl, as No. 7. Diam. 24.0. Found on top of No. 17.
16. Black Slip II jug, as No. 12. Paint obliterated. Height 11.2. — 67.
17. Plain White Wheel-made bowl, as No. 7. Diam. 20.5. — 63.
18. White Painted V globular jug with flattened base; wide, cylindrical neck; small, flat rim; raised handle from rim to shoulder, and a tubular spout opposite the handle. Encircling lines around rim, neck, and belly; parallel, oblique lines on shoulder, and bands of vertical lines from belly to base. Longitudinal lines on spout, and transverse lines on handle. Height 8.1. — 56.
19. Monochrome bowl, as No. 9. Diam. 15.0. Found inside No. 20.
20. Plain White Wheel-made bowl, as No. 7. Diam. 22.3. — 61.
21. Black Slip II miniature jug, as No. 12, but with round base. Handle missing; paint obliterated. Height 7.0. — 60.
22. Base-ring II bowl, as No. 2, but with deep, conical body. Diam. 12.1. — 58.
23. Monochrome bowl, as No. 9. Diam. 12.6. — 63.
24. Plain White Wheel-made oval jug with flat base; a ridge between neck and shoulder; concave neck; thickened rim; pinched mouth, and handle from rim to shoulder. Height 26.4. — 72.
25. White Painted V miniature jug, as No. 18. Height 8.1. — 56.
26. Plain White Wheel-made oval jug with round base; narrow neck, and handle from rim to shoulder. Upper part of neck missing. Height 12.0. — 56.
27. Black Slip II oval jug with flat base; wide, tapering neck, and handle from rim to shoulder. Rim, handle, and part of neck missing. Paint worn. Height 15.8. Found on top of No. 36.
28. Plain White Wheel-made bowl, as No. 7. Diam. 18.7. Found inside No. 29.
29. Plain White Wheel-made bowl, as No. 7. Diam. 20.5. — 75.
30. Levanto-Helladic shallow bowl with base-ring; raised, curved rim, and handle from rim to body. Decoration almost obliterated. Fragments of running spirals visible below rim. Diam. 12.8. — 75.
31. Plain White Hand-made delicately shaped, oblong bottle with very narrow base-ring, distinct shoulder; tall, tapering neck; wide, flat rim, and handle from neck to shoulder. Rim chipped; base-ring missing. Height 15.0. Floor.
32. Black Slip II jug, as No. 27, but with widening rim, and somewhat pinched mouth. Paint worn. Height 20.5. — 82.
33. Black Slip II jug, as No. 32. Height 18.6. — 82.
34. Levanto-Helladic squat pyxis with large, flat base; conical shoulder; short, concave neck; flaring rim, and three horizontal handles on shoulder. Encircling lines around rim, shoulder, and body; an encircled spiral on base, and a band of herring-bone pattern between handles. Diam. 13.2. — 79.
35. Plain White Wheel-made bowl, as No. 7, but slightly deeper. Diam. 16.7. — 80.
36. Black Slip II jug, as No. 32. Height 17.0. Found on top of No. 37.
37. Base-ring II jug, as No. 4. Rim chipped. Height 27.3. — 79.
38. Plain White Wheel-made bowl, as No. 7. Diam. 19.8. — 70.
39. Plain White Wheel-made shallow bowl with base-ring; rim thickening inwards, and a string-hole handle at rim. Diam. 21.1. Found on top of No. 40.
40. Plain White Wheel-made bowl, as No. 39. Diam. 20.6. — 67.
41. White Shaved bottle, as No. 5, but with less splayed rim. Height 17.0. Floor.
42. Monochrome bowl, as No. 9. Handle missing. Diam. 12.2. Floor.
43. Plain White Wheel-made jug, as No. 24. Height 18.1. Floor.
44. Black Slip II jug, as No. 32. Height 16.2. Floor.
45. Levanto-Helladic amphoriskos, as No. 6, but with horizontal herring-bone pattern between handles. Height 16.5. — 68.
46. Monochrome bowl, as No. 9. Diam. 12.2. Found on top of No. 47.
47. Plain White Wheel-made bowl, as No. 7. Rim chipped. Diam. 19.8. Found on top of No. 51.
48. Red Lustrous Wheel-made tall, narrow bottle with base-ring; slanting shoulder; tall, tapering neck; large, flattened rim, and handle from neck to shoulder. Height 31.7. — 77.
49. Base-ring II pear-shaped amphoriskos with narrow, raised base; rounded shoulder; short, concave neck; flat rim, and three small, vertical handles on shoulder. Dotted band-ornaments in white around rim, and on shoulder. Height 12.3. — 77.
50. Plain White Wheel-made bowl, as No. 7, but with raised, indented rim, and a horizontal, cylindrical string-hole handle at rim. Diam. 21.3. Found on top of No. 51.
51. Plain White Wheel-made bowl, as No. 7. Rim chipped. Diam. 20.5. — 84.
52. Plain White Wheel-made bowl, as No. 7. Diam. 18.7. Found on top of No. 54.
53. Plain White Wheel-made bowl, as No. 50. Diam. 12.7. Floor.
54. Plain White Wheel-made bowl, as No. 7, but slightly deeper. Diam. 19.0. — 81.
55. Levanto-Helladic amphoriskos, as No. 6, but with groups of oblique chevrons between handles. Height 16.5. — 63.
56. Levanto-Helladic amphoriskos, as No. 6, but with a network band between handles. Height 16.0. — 63.

57. Base-ring II jug, as No. 3. Height 22.6. — 71.
58. Plain White Wheel-made bowl, as No. 50. Diam. 21.2. — 70.
59. White Shaved bottle, as No. 41. Height 17.2. Floor.
60. Base-ring II bowl, as No. 2. Diam. 9.0. Floor.
61. Shallow gold bowl with round base, and plain edge. Slightly embossed here and there. Rim split at one point. Diam. 16.6. — 71.
62. Broad diadem of thick gold leaf with convex sides, and straight ends, each pierced by two holes. The whole surface is honey-combed with small circles in two sizes forming roughly vertical lines in enchased work. Gold not quite pure. Length 15.8. — 70.
63. Mouth-piece of gold leaf with straight sides and ends; two holes at each end. Decorated as No. 62. Length 8.2. — 72.
64. Strip of plain gold leaf with slightly convex sides, and rounded ends; one hole at each end. Length 11.4. — 76.
65. Strip of plain gold leaf, as No. 64. Length 11.0. — 70.
66. Strip of plain gold leaf, as No. 64. Length 8.0. — 64.
67. Strip of plain gold leaf, as No. 64. Length 3.5. — 73.
68. Strip of plain gold leaf, as No. 64. Length 9.2. — 76.
69. Strip of gold leaf with one straight and one rounded end. One hole through each end. Gold not quite pure. Length 6.5. — 80.
70. Strip of gold leaf, as No. 64. Incomplete. Length 6.2. — 73.
71. Strip of gold leaf, as No. 64. Broken in two pieces. Not quite pure gold. Length 10.0. — 73.
72. Strip of gold leaf, as No. 64. Not quite pure gold. Length 8.8. — 70.
73. Strip of gold leaf with slightly convex sides; one rounded, and one straight end. One hole in each end. Length 8.8. — 76.
74. Plain pin with a hole through the middle. It has been a silver-gilt pin, but the silver is corroded, and only the thin gold leaf left. Length 6.7. — 77.
75. Cylinder of black steatite. The central part of the representation is a conventionalized palm-tree, round the root of which crawls a snake, raising its head to the lower branches. By the tree stands a man, dressed in a short tunic with his left hand raised to feed an animal. Behind him on the ground is an inverted bucranium, and before him another upright. The animal seems to be a panther or a lion, and sits on its hind legs with head erect, bushy mane, and raised forelegs. Length 1.9. Found in the sieves.
76. Plain, circular disc of ivory. Diam. 7.6. Circular disc of ivory with a hole through centre; ornamented with a large rosette, framed by narrow bands with groups of parallel lines. They are the bottom and lid of a cylindrical box (cf. Tomb 11.35). Diam. 7.7. — 61.
77. Fragments of a bronze knife. — 59.
78. Straight, silver-gilt pin with rounded head. Upper part decorated with horizontal flutings, alternating with dotted lines. Broken in two; the silver much corroded. Length 11.8. Floor.
79. Strip of gold leaf with slightly concave sides, and rounded ends, pierced by holes. Length 11.5. — 82.
80. Strip of gold leaf, as No. 79. Length 5.8. Floor.
81. Straight ivory pin with two incised lines at one end. Incomplete. Length 8.0. Floor.
82. Solid gold pin with upper part in plaited filigree work, and lower part plain. A loop in the middle, and a fluted, blue paste bead, surmounted by a similar gold one. Length 14.0. — 73.
83. Strip of gold leaf, as No. 79. Length 15.2. Floor.
84. Strip of gold leaf with slightly convex sides, and rounded ends, pierced by holes. Length 12.9. Floor.
85. Strip of gold leaf, as No. 84. Length 9.1. Floor.
86. Plain, circular, gold earring. Diam. 2.5. Floor.
87. Flat, circular bead of blue paste; a hole near the centre. Diam. 1.0. Floor.
88. Plain White Wheel-made bowl, as No. 7. Diam. 25.0. Floor.
89. Red Lustrous Wheel-made bottle, as No. 48. Height 19.4. Floor.
90. Base-ring I depressed, globular jug with tall, tapering neck; funnel-rim, and handle from neck to shoulder. The longitudinal axis of the vase leans slightly backwards. Height 12.5. Floor.
91. Base-ring I squat, biconical jug with wide neck; flat rim; ridges around neck; handle from rim to shoulder, and a knobbed projection on top of handle. Rim and projection chipped. Height 6.9. Floor.
92. Plain White Wheel-made bowl, as No. 7. Diam. 24.1. Floor.
93. Black Slip II miniature jug, as No. 12. Base smashed. Height 6.9. Floor.
94. Black Slip II jug, as No. 12. Uneven surface. Height 12.5. Floor.
95. Black Slip II miniature jug, as No. 12. Uneven surface. Height 8.9. Floor.

The diagram below gives a distribution of the three groups of finds:

	Pottery														Bronze	Silver	Gold	Terra-cotta	Fai-ence	Ivory	Glyp-tic			
	Hand-made					Wheel-made																		
	Bl. Sl. II	Wh. P. V	Base-ring I	Base-ring II	Pl. Wh.	Wh. Shaved Monochrome	Bl. Lustr.	Red Lustr.	Pl. Wh.	Levanto-Helladic	Knife	Pin	Pins	Earring								Strips	Diadem	Mouth-piece
1st group	44. 93. In 94. 95. fragm. -4 In fragm. + -8	1	90. 91 -2 In fragm. 4	60 -1 In fragm. 2	31 41 42			89 43 53 88 92												87				
2nd group	12, 16 21, 27 32, 33 36	18 25		3 4 22 37 49 57	5 9 13 48	7, 8 15, 17 20, 24 26, 28 29, 35 38, 39 40, 47 50, 51 52, 54		6 77				74 86 82	64, 65 66, 67 68, 69 70, 71 72 73 79, 80 83, 84 85					14			81 76 76		75	
3rd group		-7 -2		-6	-1 -6 -1 -1		-18	-6	-1			-2 -1	-15						-1			-1 -2	-1	
				2 -1	59 -1		58 -1	1 -1			78 -1					62 63 61 -1 -1 -1								

CHRONOLOGY

The first burials fall within Late Cypriote I. This is shown both by the presence of the Middle Cypriote and Base-ring I pots, and by the absence of Levanto-Helladic Ware. In the next group there are still several Middle Cypriote pots but also some Levanto-Helladic ones. The group is thereby assigned to the beginning of Late Cypriote II. The third small group with the large amphora No. 1 and the golden bowl is slightly younger, and ought to be assigned to a date before the middle of Late Cypriote II.

TOMB 18 (Figs. 207; 208; 209: 1-4, 7; 210; 211)

SIZE

	Length	Width	Depth	Height
Dromos	1.22	0.97	1.10	—
Stomion	0.26	0.83	—	c. 0.85
Chamber	2.55	2.87	—	c. 1.80
Side-chamber 1	1.60	1.74	—	c. 1.05
Side-chamber 2	1.02	1.17	—	c. 0.75



Fig. 207. Enkomi. Tomb 18, dromos.

Fig. 208. Enkomi. Tomb 18. Finds and skeletons *in situ*.

SHAPE

The dromos is a roughly rectangular shaft with rounded corners, perpendicular sides, and flat, horizontal floor. It was almost entirely filled with large, rough stones, forming a very solid packing, not only in front of the stomion, but also along the whole N. side. The reason of this peculiarity was revealed when the stones were removed: the central part of this wall had fallen in because of the proximity of another tomb (Tomb 22). Thus, a connection was involuntarily established between the two tombs, and the stone-packing was built in order to divide them again, and to solidify the structure. As these stones were placed in their positions from the dromos of Tomb 18, it is clear that this tomb is later than Tomb 22.

The stomion which, like the whole tomb, had fallen in, is short and wide, and from the threshold a step leads very abruptly down to the chamber floor. The difference in level between threshold and floor is considerable and the step is very narrow. The chamber is roughly square with a gently curved back wall. The central area is sunk, and around the walls of the chamber run low ledges. Roof and walls form a flat, curved vault which could, in its essential parts, be reconstructed. From the N. W. corner, i. e., the right end of the back wall, opens a small side-chamber (Side-chamber 1) from the level of the ledge. Its shape is an irregular circle, and the walls taper gently upwards. The roof could be reconstructed according to the usual, flat, curved type.

Approximately in the centre of the back wall, a similar chamber is hewn out (Side-chamber 2). It is also circular in shape with a horizontal floor. The roof had entirely fallen in. The back wall of this side-chamber communicates with a well, sunk some 2.00 m. in the rock, and dug from a Byzantine floor about 0.60 m. above the edge of the natural rock. The well is square in section and very regularly cut. It is, of course, Byzantine in date. Considering the structural evidence for the date of the side-chambers, some architectural details are worth noting. There is a striking lack of real composition in the connection between the main chamber and the side-chambers. They are asymmetrically arranged, cut on different levels, and seem not to have anything to do with the original plan of the

chamber, which was fairly regular. Finally, the step from the threshold of Side-chamber 2 to the ledge of the back wall is not perpendicular, but overhangs considerably. In order to solidify the structure, it was supported by an upright stone slab, standing on the ledge, and placed on top of finds Nos. 78 and 109. Apparently, the curved line of the overhanging section marks the inclination of the original back wall, and from this, it can be concluded that Side-chamber 2 is a secondary construction. It is, too, very probable, that it is the later of the two side-chambers, as it was never used for its purpose (cf. below). By analogy, it may be supposed that Side-chamber 1, too, is of secondary character, and this supposition is corroborated by consideration of its special purpose.

STRATIFICATION

The Byzantine layer above the tomb was very massive, and the roof of the chamber had collapsed under the weight of the superimposed masses. As mentioned above, there was a floor of Byzantine date about 0.60 m. above the natural rock. It rested on accumulated earth of earlier times, probably consisting chiefly of the original field-earth of the site. Above the chamber, the floor was broken and the whole building entirely destroyed by the collapse of the underlying ground. Debris from the settlement, including dressed building-stones, were found immediately above the thick layer of *chavara* and pieces of rock which marked the final collapse of the roof. Below this layer was a stratum of fine rock material. It reached its maximum thickness in the right portion of the chamber, and emanated, evidently, from the gradual erosion of roof and walls after the last burials in the chamber. These are represented by a thick burial layer, covering the whole area. Around the walls it rested directly on the ledges, and in the central basin on a horizontal layer of *chavara*, which brought it up to the same level. The lower section of the basin contained a mixed layer of clay, culture earth, and burial remains. The whole layer was very wet and silted, as it was found in and below the level of the ground-water. When it was excavated, a pump was in constant use to draw off the water, which poured in from all sides of the basin (see Fig. 210).

Side-chamber 1 contained a thick bottom layer of culture earth containing many finds, but no distinct burial strata. Above this lay rock debris from the roof, stratified in two layers. The other side-chamber was filled with a layer of bluish clay which had flowed in from the Byzantine well, and also intruded into the main chamber of the tomb. It contained no finds. In the dromos, no stratigraphical observations could be made because of the extensive stone-packing.

The stratification of the chamber is clear enough to show the two different burial periods. The main proof is the horizontal layer of *chavara* spread over the silted filling in the central basin. What was found below this level must be attributed to a period earlier than that represented by the burial layer on top of the *chavara* stratum. These finds were Nos. 56, 74, 79—81, 83, 93—96, 100—106, 114, 121—126, and 128. The ledges may have been occupied in this early epoch too, but the burials actually found on them can all be ascribed to the later period: that is demonstrated by the general disposition of the bodies. Some of

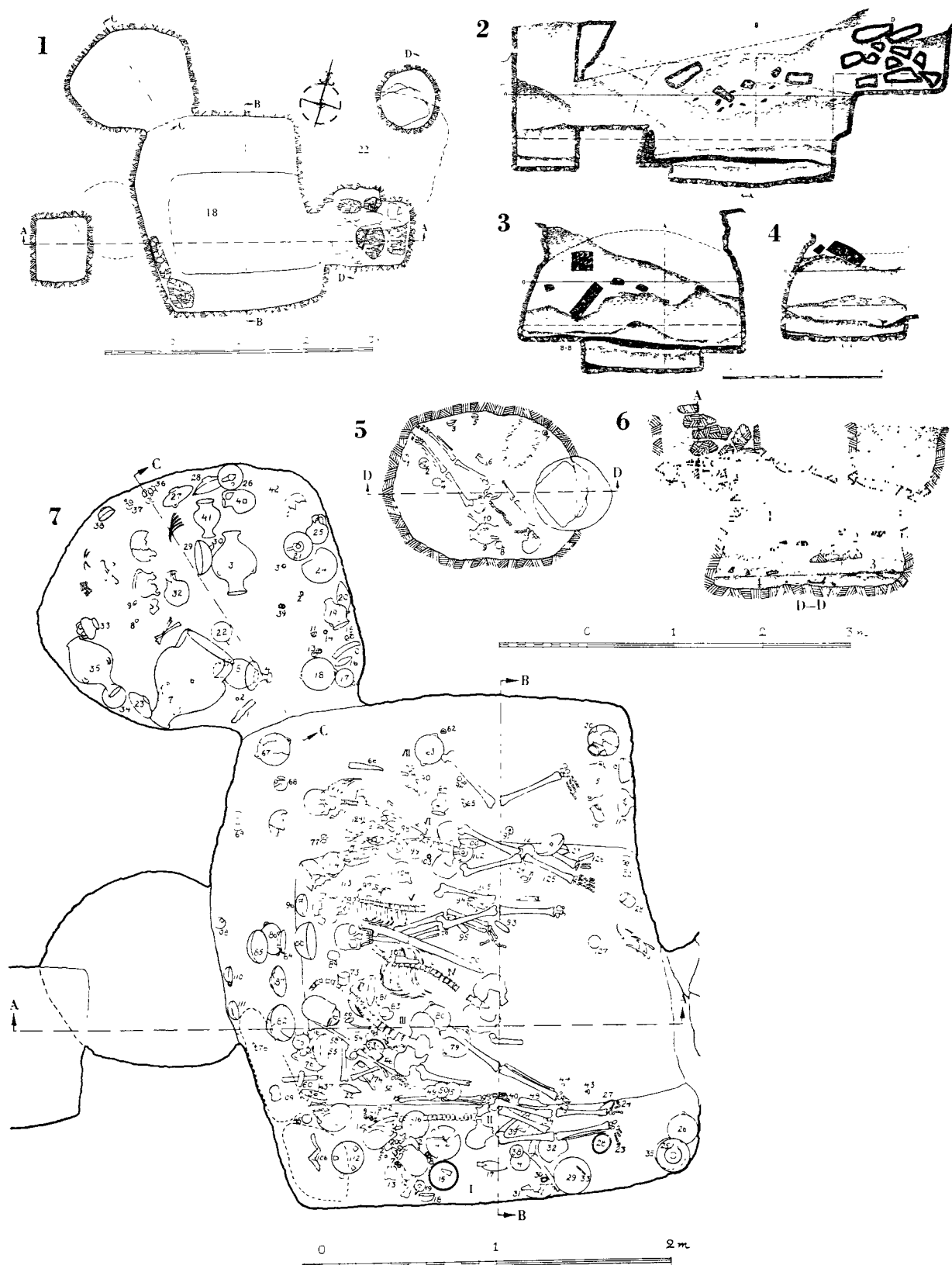

Fig. 209. Enkomi. Tomb 18, Plan (1); Sections A—A, B—B, C—C (2—4); Finds *in situ* (7). Tomb 22, Plan (5); Section D—D (6).



Fig. 210. Enkomi. Tomb 18 during excavation.



Fig. 211. Enkomi. Tomb 18. Side-chamber 1. Finds *in situ*.

them are lying partly on and partly off the ledge, and consequently the floor-level in the chamber, when they were deposited, was the same as that of the ledges. It is, however, clear that the ledges were occupied in the earlier epoch, too: for the bodies and the finds of this earlier group have, evidently, been removed, and were to be found in Side-chamber 1 which was, apparently, cut for that especial purpose (cf. above). The finds in Side-chamber 1 are consequently to be dated to the earlier group, and are roughly contemporary with the finds in the bottom layer of the central basin.

Side-chamber 2 was evidently cut with the intention of fulfilling a similar purpose, but this second clearance of the chamber was, for some reason, never carried out. Thus, the structural evidence for the secondary characters of the side-chambers is given conclusive value by the stratification.

BURIALS

The skeletal remains of the earlier epoch are very scanty. In the silted burial earth of the central basin, practically no bones were left intact. A fragmentary skull was found at the E. end, a femur by the N., and some ribs by the W. wall. Scattered fragments of about three dead bodies were found in Side-chamber 1. From the later period all the skeletal material is fairly well preserved. Seven skeletons were found, numbered from left to right: I—VII. Skeleton I was lying along the S. wall on the ledge. It had been partly moved by subsequent burials, and its original position could not be safely stated. It was provided with fine tomb-gifts among which the gold hair-rings Nos. 7 and 8, the finger-ring No. 5, the diadem No. 2, and the ivory comb No. 13 are worth mentioning. On the

left side of this body lay a richly adorned, female skeleton (II) in an outstretched, dorsal position. The diadem No. 1, the gold earrings Nos. 9—11, the mouth-piece No. 4, and the magnificent necklace No. 20 were found *in situ* on and around the skull. The bronze mirror No. 16 was lying on her breast. The middle finger of the left hand was adorned with the gold ring No. 40, around the ankles were the bronze rings Nos. 27 and 28, and on the toes the gold rings Nos. 23 and 24. Finally the elegant ivory box No. 39 lay in her bosom.

To the left lay, side by side, two male skeletons in similar positions (III and IV). The latter had, over his left shoulder, a large sword of the common Mycenaean type (No. 70). Further to the left, lay two other male skeletons, also in dorsal positions (V and VI). No. IV had the helmet No. 129 on the right side of his breast, the glass bottle No. 122 at his feet, a fragmentary spear-head (No. 66) at his side, and many other fine tomb-gifts around him. Finally, along the right side wall of the chamber lay fragments of a skeleton (VII) on the ledge. The left leg and fragments of the skull were the only remains. The leg was slightly bent at the knee and indicated a lateral, rather than a dorsal position. The splendid signet-ring No. 62 was its principal tomb-gift.

To complete the review of the skeletal remains, a few fragments of a skull, found in the left corner of the back wall on the ledge, has to be mentioned. It was lying together with the diadem No. 106 below the above-mentioned stone, and may be the remainder of a burial of the earlier epoch.

FINDS (GROUPS: PLS. LXXXVIII; LXXXIX; XC; TYPES: L. OF PL. II)

Chamber

- | | |
|---|---|
| <ol style="list-style-type: none"> 1. Large gold diadem with straight sides and ends, and rounded corners, pierced by two holes. Two horizontal lines of open, double palmettes, separated from each other with lines of dots; a dotted line around edge. Length 21.8. Found on Skull II. 2. Broad gold diadem, as No. 1. Large, plain palmettes with volutes and flower rosettes in their interstices; a dotted line around edge. Length 19.0. Floor. 3. Mouth-piece of gold leaf with very convex sides; narrow, rounded ends, pierced by holes. Conventional design of a mouth in the centre. Length 10.9. Floor. 4. Mouth-piece of gold leaf, as No. 3, but with less convex sides. An embossed design of two lips in the centre, bordered by small irregular lines, suggesting beard and moustaches. Length 8.6. Floor. 5. Thin gold finger-ring; the front part widens to an oval bezel, engraved with a conventionalized design of a fish, surrounded by hatched lines. Diam. 1.8. Floor. 6. Fragments of a circular ivory disc with a border of two parallel zigzag lines. Diam. c. 9.5. Floor. 7. A pair of solid, spiral hair-rings of gold. Diam. 2.5. Floor. 8. Hair-rings, as No. 7. Diam. 2.4. Floor. 9. A pair of crescent-shaped, solid earrings of gold. Diam. 1.6. Floor. 10. Earrings, as No. 9. Diam. 1.6. Floor. | <ol style="list-style-type: none"> 11. Earrings, as No. 9. Diam. 1.6. Floor. 12. Roughly circular, plain disc of thick ivory with indented edge. Diam. 7.0. Floor. 13. Short, almost square comb of ivory with rectangular handle with one concave side. The handle is adorned similarly on both sides, with a roebuck lying down with one foreleg, and head raised. The handle is bordered by two rows of small squares. Length 7.5. Floor. 14. Fragments of a circular bronze bowl with thickening rim, and round base. Much corroded. Floor. 15. Round, shallow bowl of black steatite with straight rim; round base, and three feet. Pestle in shape of a truncated cone. Diam. 16.7. Floor. 16. Circular bronze mirror with a small projection for the handle. On the projection are traces of a plain ivory handle. Broken and much corroded. Diam. c. 16.5. Floor. 17. Short, broad, triangular bronze spear-head with midrib, and two sharp edges. Socket missing. Badly corroded. Length c. 18.0. Floor. 18. Levanto-Helladic shallow bowl with base-ring; angular outline; splaying rim, and handle from rim to body. Encircling lines around rim, body, and base; concentric circles inside the bottom. Mat paint. Diam. 9.0. Floor. 19. White Painted Wheel-made oval jug with flat base; concave neck; splaying rim; handle from rim to |
|---|---|

- shoulder, and a tubular spout on shoulder opposite the handle. A line between neck and shoulder, and four vertical lines from neck to shoulder. Height 6.5. Floor.
20. Necklace composed of ten large and eleven small gold beads. Two of the smaller beads are destroyed. The larger beads have the characteristic shape of the Mycenaean double-shield, designed in two convex halves of chased work hammered together at the edges. Around the edges of the beads run two dotted lines. The smaller beads are composed of three tubes, made of spirally twisted gold wire. Small and large beads alternated. Length 31.7. Floor.
 21. Mouth-piece of gold leaf with convex sides, and sharp corners, pierced by holes. A conventional design of lips in the centre. Length 9.2. Floor.
 22. Mouth-piece of gold leaf with convex sides, and narrow, rounded ends, pierced by holes. A dotted line around the edge; spirals and a conventional design of lips in the centre. Length 13.7. Floor.
 23. Plain, circular toe-ring of gold. Diam. 1.4. Floor.
 24. Plain, circular toe-ring of gold. Diam. 1.4. Floor.
 25. Plain White Wheel-made oval jug with base-ring; concave neck; thickened rim, and handle from rim to shoulder. Handle chipped; smooth surface. Height 26.5. Found on No. 35.
 26. Levanto-Helladic wide, shallow bowl with base-ring; conical, straight sides; out-turned rim, and two horizontal handles at rim. Encircling lines outside, and around rim; concentric circles inside; groups of radiating, wavy lines between two of the concentric circles. Mat paint. Diam. 17.0. Floor.
 27. Circular anklet of bronze with a gap between the ends. Diam. 12.1. Floor.
 28. Anklet, as No. 27. Diam. 11.5. Floor.
 29. Deep bronze bowl with round base, and thickening rim. Broken. Diam. 20.5. Floor.
 30. Circular bronze ring. Diam. 4.5. Floor.
 31. Fragment of a bronze bowl with round base, and thickening rim. Floor.
 32. Levanto-Helladic bowl, as No. 26. Encircling lines outside the bowl, and around rim; an encircled spiral inside the bottom. Incomplete. Mat paint. Diam. 17.2. Floor.
 33. Plain pin of ivory; incomplete (cf. No. 91). Length 7.7. Found in No. 29.
 34. Levanto-Helladic bowl, as No. 18. Encircling lines around rim, body, and base; an encircled spiral inside the bottom. Mat paint. Diam. 8.4. Floor.
 35. Levanto-Helladic bowl as No. 32. Incomplete. Mat paint. Diam. 16.3. Floor.
 36. Greyish steatite bowl, as No. 15, but with spreading legs. Edge chipped. Diam. 15.0. Floor.
 37. Mouth-piece, as No. 22. A dotted line around edge; three spirals at each end; pairs of connected spirals, and two short, dotted lines, forming a conventionalized design of a mouth. Length 11.3. Floor.
 38. Plain, nearly circular disc of thick ivory, with indented edges. Diam. 7.7. Floor.
 39. Prism-shaped box of ivory with triangular section, and a round hole through the centre of one short end. Two small band-ornaments around each end of the box, and three small holes on top. Length 9.4. Floor.
 40. Finger-ring of thin gold, bordered by dotted lines in filigree-work; a large circular bezel, bordered with double lines of the same work. A plain, bright-blue bead of faience is mounted in the bezel. Diam. 2.0. — 84.
 41. Thin, circular disc of ivory with a hole through centre. Diam. 10.7. Floor.
 42. Gold bead, composed of sixteen small beads, arranged in two rows. Diam. 0.7. Floor.
 43. Convex, circular button of ivory with a small peg. Has probably been the knob of a drawer of a wooden chest (cf. No. 90). Diam. 1.5. — 88.
 44. Small head of a pin made of circular, convex gold leaf. Diam. 1.2. — 88.
 45. Almost circular disc of ivory with indented edges. Chipped. Diam. c. 5.2. Floor.
 46. Ivory disc, as No. 45. Diam. 5.2. — 83.
 47. Two spiral rings of bronze; badly preserved. Diam. 4.5; 3.2. Found in the sieves.
 48. Irregular piece of bronze, probably part of a mirror. Length 16.7. Floor.
 49. Levanto-Helladic bowl, as No. 18. Mat paint. Diam. 8.0. Found on top of No. 50.
 50. Levanto-Helladic bowl, as No. 34. Mat paint. Diam. 9.2. Found on top of No. 51.
 51. Levanto-Helladic bowl, as No. 18. Mat paint. Diam. 10.2. — 85.
 52. Levanto-Helladic bowl, as No. 18, but with curved outline; splaying rim, and raised handle. Mat paint. Diam. 10.7. — 85.
 53. Fragments of a bronze bowl with round base, and thickening rim. — 80.
 54. Plain White Wheel-made oval jug with base-ring; concave neck; thick, flaring rim, and handle from rim to shoulder. Height 16.5. Found on top of No. 53.
 55. Fragments of a shallow bronze bowl with round base, and thickening rim. Diam. c. 18.0. — 81.
 56. White Painted Wheel-made jug, as No. 19. Rim chipped; paint worn. Height 11.0. Floor.
 57. Levanto-Helladic small, globular stirrup-vase with base-ring. Encircling lines around rim, neck, shoulder, belly, and base; painted handles, and a frieze of U-ornaments on shoulder. Height 7.3. — 85.
 58. Fragment of a bronze ring. — 80.
 59. Circular silver bracelet. The silver is alloyed with copper. Diam. 5.7. — 83.
 60. Mouth-piece of gold with convex side, and tapering, rounded ends, pierced by holes. Two rows of small circles, surrounding a conventionalized design of lips. Length 9.0. Floor.
 61. Gold diadem with straight sides and ends; rounded corners, pierced by holes. Lines of small circles around

- the edge, and at the longitudinal axis; two bands of double spirals. Leng 19.7. Floor.
62. Horseshoe-shaped, solid gold finger-ring with large, oval bezel. On the bezel is engraved a lion, moving to the right with head turned back. Mane, muscles, ribs, and anatomy are excellently portrayed. Diam. 2.6. Floor.
 63. Levanto-Helladic bowl, as No. 32. Diam. 16.5. Floor.
 64. Levanto-Helladic pear-shaped amphoriskos with wide, concave neck; flaring rim, and three horizontal handles on shoulder. Encircling lines around rim, neck, shoulder, body, and base; painted handles, and a wavy line between handles. Two handles missing. Height 11.3. Floor.
 65. Small, chisel-shaped tool of bronze with a tapering, indented ivory handle. Handle broken; bronze much corroded. Total length 5.0. Floor.
 66. Fragments of a spear-head of bronze. Length c. 20.0. Floor.
 67. Levanto-Helladic bowl, as No. 32, but with a band of crossed, wavy lines between two of the concentric circles. Damaged. Mat paint. Diam. 17.1. Floor.
 68. Fragments of a faience bowl. Floor.
 69. Levanto-Helladic squat, biconical jug with flat base; concave, splaying neck, and handle from rim to shoulder. Encircling lines around rim, neck, shoulder, body, and base; painted handle, and a frieze of U-ornaments on shoulder. Mat paint. Height 13.7. Floor.
 70. Long double-edged bronze sword with cross-shaped handle. Badly damaged. Length c. 75.0. — 83.
 71. Fragments of a bronze bowl with round base, and thickened rim. Diam. c. 20.0. — 83.
 72. Pestle of black steatite in shape of a truncated cone. Length 4.7. — 83.
 73. Levanto-Helladic deep, cylindrical cup with round base; concave sides, and handle from rim to side. An encircled spiral on base, and a framed frieze of hatched triangles and wavy, horizontal lines on sides. Careless design. Mat paint. Height 7.6. — 83.
 74. Levanto-Helladic depressed, globular jug with base-ring; concave neck; thickened rim; slightly pinched mouth, and handle from rim to shoulder. Encircling lines around rim, neck, and belly; painted handle; triangles filled with scale-pattern on shoulder. Lustrous paint; worn. Height 12.5. Found below the skeletons.
 75. Plain White Wheel-made jug, as No. 54. Height 15.3. Found on No. 76.
 76. Levanto-Helladic flat, shallow bowl with base-ring; straight rim, and two horizontal handles at rim. Encircling lines outside and inside the base, and around rim. Lustrous paint. Diam. 17.8. Floor.
 77. Fragments of a spherical bottle of multi-coloured glass. Floor.
 78. Silver bracelet, as No. 59. Diam. 5.6. Floor.
 79. Levanto-Helladic bowl, as No. 32. Mat paint. Diam. 16.1. Found below the skeletons.
 80. Levanto-Helladic bowl, as No. 32. Mat paint. Diam. 16.3. Found below the skeletons.
 81. Oval mouth-piece of gold with rounded ends, pierced by holes. A band of running spirals surrounds a conventionalized design of a mouth. Length 6.9. Found below the skeletons.
 82. Fragments of a bronze bowl, with round base, and thickened rim. Much damaged. Diam. c. 21.0. Floor.
 83. Roughly circular disc of ivory with a hole through the centre. Incised with an elaborate design of regular pentagons with concave sides; a border of volutes, and parallel, curved lines. One segment missing. Diam. 7.1.
Plain disc, as above. Diam. 6.4. Found below the skeletons.
 84. Bowl of greyish steatite, as No. 15. Incised zigzag lines around body, and crossed lines on legs. Diam. 13.8. Found on top of No. 86.
 85. Fragments of a bronze bowl, as No. 82. Diam. c. 19.0. Found on top of No. 86.
 86. Levanto-Helladic bowl, as No. 76. Encircling lines around rim and base; an encircled spiral inside the bottom, and ornaments of dotted stars and crosses in white colour on the dark bands. Lustrous paint. Diam. 18.2. Floor.
 87. Levanto-Helladic bowl, as No. 32, but with concentric circles inside. Damaged. Mat paint. Diam. 17.3. Floor.
 88. Fragments of a bronze bowl, as No. 14. Diam. c. 21.0. — 83.
 89. Oval thick bronze disc. Diam. 6.0. — 83.
 90. One short, complete strip of ivory, and fragments of two longer ones of the same width, but thinner. The short, and one of the long strips are decorated with two parallel lines of drilled holes; the third piece has only one line of holes which, in this case, actually pierce the strip right through. A fourth, very short piece of the same width has parallel, incised lines at the edges, and no holes. The strips have decorated a wooden chest, as above Tomb 11.34 (cf. No. 43). Floor.
 91. Circular ivory button with one conical side; pierced by three small holes through the edges; slightly concave upper side. A large hole through centre. It has been the head of a pin (cf. No. 33). Diam. 4.5. Floor.
 92. Circular ivory button with one flat, and one convex side; a hole through centre. Diam. 2.5.
A button or mounting of ivory, which seems to have been the head of a miniature pilaster with an oval cushion-shaped echinus and a splaying upper part. A horizontal hole through echinus. The lower part of the pilaster is probably No. 126. Length 2.5. Floor.
 93. Gold mouth-piece with convex sides, and rounded, narrow ends, pierced by holes. Design of a mouth in centre. Broken. Length 9.8. Found below the skeletons.
 94. Gold mouth-piece, as No. 22, but with encircled dots around edge. Length 11.5. Found inside No. 105.

95. Gold diadem with straight sides, and rounded corners, pierced by holes. A dotted line along the sides; two rows of eight seated sphinxes, one above the other, covers the diadem. The sphinxes are in right profile with raised wings and tail; each sphinx wears a flat cap, crowned by two fluttering plumes. Length 14.9. Floor.
96. Levanto-Helladic shallow bowl with base-ring; splaying, curved sides, and handle from rim to body. Encircling lines outside and inside rim. Paint worn. Diam. 12.5. Floor.
97. Black steatite bowl, as No. 15. Pestle in shape of a truncated cone. Length 6.4. — 83.
98. White Painted Wheel-made jug, as No. 19. Rim chipped. Paint worn. Height 8.8. — 83.
99. Plain White Wheel-made shallow bowl with flat base; curved sides; straight rim, and two string-holes through rim. Incomplete. Diam. 10.4. — 83.
100. Plain White Wheel-made flat, conical bowl with base-ring; raised, indented rim, and a horizontal handle at the rim. Diam. 16.8. Found below the skeletons.
101. Plain White Wheel-made jug, as No. 54. Height 16.2. Found below the skeletons.
102. Plain White Wheel-made jug, as No. 54, but with flat base. Height 15.0. Found below the skeletons.
103. Plain, spiral hair-ring of gold. Diam. 2.3. Floor.
104. Levanto-Helladic bowl, as No. 96. Paint worn. Diam. 11.8. Floor.
105. A few fragments of the rim of a shallow bowl of silver. Found below the skeletons.
106. Long, rectangular gold diadem with straight sides, and rounded corners. Rows of small circles around edge; a band composed of vertical, double spirals covers the whole surface. Length 26.6. Floor.
107. Rectangular piece of thick ivory in a very ruined state. It has been entirely covered by beautiful, composite patterns of scales and rosettes, which is now almost entirely obliterated. Probably the handle of a comb. Length 13.5. — 83.
108. Fragments of a fluted, spherical bottle of multi-coloured glass. Floor.
109. Fragment of a circular bone disc. Length 9.5. Floor.
110. Levanto-Helladic bowl, as No. 18. Diam. 9.4. Floor.
111. Plain White Wheel-made bowl, as No. 99, but deeper, and with a horizontal handle at rim; no string-holes. Handle missing. Diam. 11.7. Floor.
112. Bowl of grey steatite, as No. 15, but with shorter legs; pestle in shape of a truncated cone. Diam. 18.3. Length of pestle 5.2. Floor.
113. Fragments of a Levanto-Helladic oval jug. — 83.
114. Plain White Wheel-made jug, as No. 54, but with flat base. Height 15.7. Floor.
115. Levanto-Helladic goblet on high stem, and with two horizontal handles at rim. Encircling lines around rim, and a narrow band of winged lozenges inside. Diam. 18.7. Floor.
116. Base-ring II oval jug with a ridge between shoulder and neck; cylindrical neck; thickening rim, and handle from rim to shoulder. Height 10.5. Floor.
117. Base-ring II conical bowl with sharply splaying sides; raised, indented rim, and an arched wish-bone handle at rim. Diam. 16.2. Floor.
118. Plain White Wheel-made shallow bowl with round base, and slightly in-turned rim. No handle. Diam. 13.5. Floor.
119. Fragments of a bronze bowl, as No. 82. Floor.
120. Fragments of a large, globular bronze jug, with base-ring; cylindrical neck; thick rim, and handle from neck to shoulder. Height c. 30.0. Floor.
121. White Painted Wheel-made jug, as No. 19. Rim chipped; handle missing; paint worn. Height 10.7. Floor.
122. Spherical bottle of white and yellow glass in wavy patterns, shaped as a pomegranate. Height 6.5. Found below the skeletons.
123. Levanto-Helladic shallow bowl with round base; straight sides; plain rim, and a horizontal handle below rim. Encircling lines around rim, body, and base; concentric circles inside, and vertical, dotted lines from rim to base. Mat paint. Diam. 11.5. Found below the skeletons.
124. Levanto-Helladic jug, as No. 74; shoulder covered with a scale-pattern. Lustrous paint. Height 13.3. Found below the skeletons.
125. Fragments of a glass bottle, similar to No. 122. Found below the skeletons.
126. Fragment of a plain ivory pilaster (cf. No. 92). Length 9.2. Found below the skeletons.
127. Roughly circular, plain disc of ivory with indented edge. Diam. 6.9. Found below the skeletons.
128. Cylindrical ivory box with indented edges. Lid and bottom missing. Height 6.3. Floor.
129. Fragments of a bronze helmet. — 83.

Side-chamber 1

1. Broad diadem of gold leaf with straight sides, and rounded corners; two holes at each end. Decorated with vertical rows of separate spirals in enched work. Rather damaged. Length 17.3. — 65.
2. Gold finger-ring with fluted surface, and a large, round bezel, ornamented in filigree work with four spirals; surrounded by dotted lines. Diam. 1.8. — 65.
3. Crescent-shaped earring of plain, solid gold. Diam. 1.6. — 70.
4. Levanto-Helladic shallow bowl with hollow stem; splaying rim; conical outline, and two horizontal handles on rim. Encircling lines both outside and inside; white zigzag lines on the interior bands. One handle missing. Slightly lustrous paint. Diam. 17.3. Found on top of No. 5.
5. Levanto-Helladic oval jug with base-ring; concave, splaying neck, and handle from neck to shoulder. Encircling lines around rim, neck, and belly; a design of a bull on shoulder opposite the handle. The bull

- is moving to the right with lowered head; the body is covered with small, hooked lines, and the hind quarters are decorated with small circles. On the handle are two graphical signs. Lustrous paint. Height 24.4. — 68.
6. Levanto-Helladic pear-shaped amphora with high base; wide, cylindrical neck; stilted rim, and two handles from rim to shoulder. Neck and base painted; encircling lines around lower part of body, and vertical lines on handles. Around shoulder and belly runs a frieze with bulls and birds. Close to one handle stands a bull in right profile with raised tail and lowered head, attacking another bull in a corresponding position. Between the feet of the bulls sit waterbirds, and below the heads is another small bull with a similar bird on its head. On the opposite side of the vase stands a third bull in left profile with his head bent back, and licking his shoulder. From the left, two bulls are attacking him, both in positions similar to the fighting bulls on the other side of the vase. On this side, too, are waterbirds between the feet of the animals. As filling ornaments above the backs of the bulls are filled and latticed lozenges. Below the handles are doves. The bodies of the large animals are entirely covered with dotted circles in white. Half of the decoration is much worn. On handles are incised graphical signs. Dark, lustrous paint. Height 52.5. — 78.
 7. Levanto-Helladic shallow bowl with flat base, and a clumsy wish-bone handle below rim. Encircling lines both inside and outside; an encircled spiral in the bottom. The interior lines are decorated with dotted circles in white. Dark, lustrous paint. Diam. 19.3. Found inside No. 6.
 8. Plain, circular spiral hair-ring of gold. Diam. 2.3. — 69.
 9. Two crescent-shaped earrings of gold. Diam. 1.8. — 75.
 10. Diadem of gold leaf, as No. 1. Two rows of so-called Cypriote radiating pillars; the lower row inverted. The "pillars" are of palmette type. Length 18.6. Floor.
 11. Horseshoe-shaped gold finger-ring with a large, oval bezel, ornamented in engraved work with a bull, a crescent, and a sun-disc. Diam. 2.3. Floor.
 12. Two earrings, as No. 9. Diam. 2.1. Floor.
 13. Two hair-rings, as No. 8. Diam. 3.1. Floor.
 14. Flat, circular gold toe-ring with an impressed line around the middle. Diam. 1.8. Floor.
 15. Two earrings, as No. 9. Diam. 2.0. Floor.
 16. Mouth-piece of gold leaf with convex sides, and rounded ends, pierced by holes. Decorated as No. 10. Length 11.4. Floor.
 17. Base-ring II conical bowl with in-turned, raised rim, and a hooked wish-bone handle below rim. Diam. 10.3. Floor.
 18. Levanto-Helladic shallow bowl with raised base, and two horizontal handles at rim. Red, lustrous paint. Diam. 18.5. Floor.
 19. Levanto-Helladic pear-shaped amphora with high, raised base; short, concave neck; stilted rim, and three vertical handles on shoulder. Encircling lines around rim, neck, body, and base; black handles, and a wavy line, provided with oval eye-ornaments between handles. Dark, slightly lustrous paint. Height 16.6. Floor.
 20. White Shaved bobbin-shaped bottle with pointed end; narrow, concave neck; pinched mouth, and handle from rim to shoulder. Rim and handle missing. Height 18.2. Floor.
 21. Levanto-Helladic squat, globular jug with base-ring concave neck; splaying rim, and handle from rim to shoulder. Encircling lines around rim, neck, and body; a frieze of chevrons, alternating with dotted, concentric circles around shoulder. Piece of rim missing. Dark, slightly lustrous paint. Height 18.5. Floor.
 22. Levanto-Helladic shallow bowl with flat, raised base; curved outline, and handle from rim to body. Encircling lines outside and inside. Red, slightly lustrous paint. Diam. 11.9. Floor.
 23. Levanto-Helladic bowl, as No. 18. Handles missing. Diam. 17.5. Floor.
 24. Fragments of a shallow bronze bowl with round base, and stilted rim. — 73.
 25. Levanto-Helladic jug, as No. 21, but with chevrons and spirals around shoulder. Dark, slightly lustrous paint. Pieces of rim and neck missing; paint partly worn. Height 15.7. Floor.
 26. Levanto-Helladic squat stirrup-vase with base-ring. Encircling lines around neck, shoulder, belly, and base; concentric circles on the knob; transverse lines on handles, and triangular groups of parallel lines on shoulder. Red, slightly lustrous paint. One handle missing; paint partly worn. Height 10.3. Floor.
 27. Levanto-Helladic bowl, as No. 18. Encircling lines outside and inside; herring-bone pattern on rim; the interior lines decorated with wavy lines in dark. Red, slightly lustrous paint. Diam. 20.5. — 57.
 28. Levanto-Helladic bowl, as No. 18. Dark, slightly lustrous paint. Diam. 17.7. Floor.
 29. Fragments of a bronze bowl, as No. 24. — 66.
 30. Bobbin-shaped bottle of dark glass with pointed end, and cylindrical neck. The decoration consists of white, wavy and arched lines, forming a symmetrical pattern, inlaid on the dark surface. Traces of three small, vertical handles on shoulder. Height 10.3. — 62.
 31. Levanto-Helladic pear-shaped jug with tall, raised base; concave neck; stilted rim, and three vertical handles on shoulder. Painted neck and base; encircling lines around shoulder, belly, and lower part of body; bands of scale-pattern, framing concentric semi-circles between handles; groups of transverse lines on rim. On the handles are incised graphical signs. Red, slightly lustrous paint. Base chipped, paint worn. Height 35.1. Floor.
 32. Plain White Wheel-made globular jug with flat, raised base; concave neck, and handle from rim to shoulder. Pieces of rim and neck missing. Height 19.8. Floor.

33. Levanto-Helladic squat stirrup-vase, with high base-ring. Encircling lines around body and base; an encircled dot on the knob; hooked and dotted lines on shoulder. Red, lustrous paint. Height 12.2. Floor.
34. Levanto-Helladic shallow bowl with flat, raised base, and a horizontal handle at rim. Encircling lines outside and inside. Red, mat paint. Handle missing. Diam. 11.8. Floor.
35. Levanto-Helladic oval jug with base-ring; narrow, concave neck; splaying rim, and three small, vertical handles on shoulder. Encircling lines around rim, neck, shoulder, belly, and base. Paint worn. Dark, mat paint. Height 37.4. — 75.
36. Fragments of an ostrich egg. Floor.
37. Globular bottle of multi-coloured glass in the shape of a pomegranate. The decoration consists of arched bands of darker colour, inlaid on the white surface. Incomplete. Floor.
38. Levanto-Helladic shallow bowl with base-ring; angular outline; splaying rim, and handle from rim to body. Encircling lines outside and inside. Dark, mat paint; paint worn. Diam. 10.5. — 70.
39. Two gold hair-rings, as No. 8. Diam. 2.4. Floor.
40. Plain White Wheel-made jug, as No. 32. Height 18.3. Floor.
41. Levanto-Helladic amphora, as No. 19, but with slightly taller neck. Encircling lines around rim, neck, body, and base; a band of loops between handles. Dark, slightly lustrous paint. Height 20.5. Floor.
42. Fragments of a bronze bowl, as No. 24. Floor.
- Supplementary catalogue*
43. Levanto-Helladic deep crater with base-ring; rounded outline; flat, slightly splaying rim, and two horizontal handles on body. Encircling lines around rim, belly, and base; a panel-pattern consisting of a chess-board square, framed by wavy lines, and flanked by two goats in heraldic positions between the handles. Dark and red, slightly lustrous paint. Height 29.3.
44. Levanto-Helladic crater, as No. 43, but with an encircling line around lower part of body. Dark and red, slightly lustrous paint. Height 26.5.
45. Levanto-Helladic crater, as No. 43. A chess-board square framed by vertical, fringed, straight lines, flanked by two conventionalized designs of fishes between the handles. Red, slightly lustrous paint. Piece of rim missing. Height 27.6.
46. Levanto-Helladic crater, as No. 43. A frieze of running bulls between the handles. The bodies of the bulls are decorated with small stars; the shoulders and hind quarters are dotted; from three of the bulls hang wavy ribbons from the horns. Lattice-lozenges, chevrons, and small spirals serve as filling ornament. Red, slightly lustrous paint. Height 31.7.
47. Levanto-Helladic crater as No. 43. A frieze of water birds runs between the handles; small lozenges serve as filling ornaments. Around the edge of the base-ring runs an inscription. Height 31.9.
48. Levanto-Helladic crater, as No. 43. A panel-pattern of squares, filled with U-shaped ornaments framed by vertical, fringed lines. Below the handles are conventionalized designs of small horses or bulls. On one handle is a graphical signs. Red, slightly lustrous paint. Incomplete. Height 25.7.
49. Levanto-Helladic crater, as No. 43, but with slightly more tapering base. Between the handles is a decoration of running spirals. Dark, mat paint. Rim chipped. Height 25.0.
50. Levanto-Helladic crater, as No. 43; encircling lines as No. 44. Below rim is a fringed line; between handles a frieze with a decoration, consisting of lions, hunting goats. Some of the goats are still grazing in a forest, indicated by tall twigs. Below the handles are small pyramids of scale-pattern, probably suggesting the stony ground. The design is very impressionist, and rather carelessly done. Dark, mat paint. Pieces of body missing. Height 29.8.
51. Levanto-Helladic crater, as No. 43, but with raised base-ring. Encircling lines, as No. 44. Painted red inside; a series of hooked lines between the handles. Dark, slightly lustrous paint. Height 27.8.
52. Levanto-Helladic oval amphora with base-ring; wide, cylindrical neck; flat rim, and two handles from rim to shoulder. Encircling lines around shoulder, belly, and base; a network-pattern on shoulder. Decoration much worn. Height 33.3.
53. Levanto-Helladic oval stirrup-vase with base-ring, and a ridge round the stem of the knob. Encircling lines around neck, shoulder, belly, and base. Incised graphical signs on handles. Dark, slightly lustrous paint. Height 30.6.
54. Levanto-Helladic stirrup-vase, as No. 53. Incised graphical signs on handles. Dark, slightly lustrous paint. Height 32.0.
55. Levanto-Helladic stirrup-vase, as No. 53. Incised graphical signs on handles. Dark, slightly lustrous paint. Height 32.2.
56. Levanto-Helladic stirrup-vase, as No. 53, but with raised, narrow base. A wavy line around belly, and lower part of body; triangular ornaments with concentric segments on body. Portion of spout missing. Red, slightly lustrous paint; worn. Height 26.8.
57. Levanto-Helladic pear-shaped jug with narrow, raised base; concave neck, and three vertical handles on shoulder. Decoration obliterated. Rim missing. Height 34.2.
58. Levanto-Helladic jug, as No. 57, but with flat, splaying rim. Neck painted; encircling lines around shoulder, belly, lower part of body, and base; a band of vertical zigzag lines between handles. Incised, graphical signs on two of the handles. Red, slightly lustrous paint. Height 32.8.
59. Levanto-Helladic jug, as No. 58, but with stilted rim.

* Vases put together of sherds.

- Decorations as No. 58, but with wavy and arched lines between handles. On the bottom is painted a graphical sign. Dark, slightly lustrous paint. Height 26.8.
60. Levanto-Helladic jug, as No. 58, but with vertical chevrons between handles. Red, slightly lustrous paint. Height 26.2.
61. Levanto-Helladic goblet with short stem; stilted rim, and two vertical handles at rim. Encircling lines outside and inside; the interior lines are decorated with grazing birds and small stars in white paint; transverse lines on rim. Interior decoration hardly visible. Dark, slightly lustrous paint. Stem partly missing. Diam. 20.0.
62. Levanto-Helladic bowl, as No. 18. Red, slightly lustrous paint. Diam. 19.5.
63. Levanto-Helladic squat stirrup-vase with base-ring. Encircling lines around neck and body; concentric semicircles on shoulder; a spiral on the knob. Dark, slightly lustrous paint. Height 11.5.
64. Levanto-Helladic stirrup-vase, as No. 63. Encircling lines around neck, body, and base; an encircled dot on the knob; a wavy line below shoulder, and triangular ornaments of plain and dotted lines on shoulder. Red, slightly lustrous paint. Part of one handle missing. Height 12.5.
65. Levanto-Helladic pear-shaped amphora with narrow, raised base-ring; wide, concave neck; stilted rim, and three horizontal handles on shoulder. Encircling lines around rim, neck, body, and base; a band of lozenges between handles. Dark, slightly lustrous paint. Incomplete. Height 14.8.
66. Levanto-Helladic bowl, as No. 18. Encircling lines outside, and an encircled wheel-ornament inside. Dark, mat paint; worn. Diam. 18.5.
67. Levanto-Helladic bowl, as No. 18, but with groups of transverse lines on rim. The interior lines are decorated with radiating zigzag lines in white. Dark, lustrous paint. Diam. 20.5.
68. Levanto-Helladic bowl, as No. 18. Dark, lustrous paint. Incomplete. Diam. 19.9.
69. Levanto-Helladic bowl, as No. 18. Dark, mat paint; worn. Diam. 18.6.
70. Levanto-Helladic bowl, as No. 18. Dark, mat paint; paint worn. Diam. 18.6.
71. Levanto-Helladic bowl, as No. 61. Encircling lines outside and inside. The interior is decorated with small lattice lozenges. Red, slightly lustrous paint. Diam. 19.5.
72. Levanto-Helladic bowl, as No. 18. Dark, lustrous paint. One handle missing. Diam. 17.6.
73. Levanto-Helladic bowl, as No. 18. Red, slightly lustrous paint. Diam. 18.6.
74. Levanto-Helladic oval jug with base-ring; concave neck, and handle from rim to shoulder. Encircling lines around rim, neck, and belly; a design of two grazing bulls on shoulder. The hind quarters of the bulls are of a conventionalized design, resembling a wheel with encircled dots in the sectors, and the necks are decorated with small stars. Dark, slightly lustrous paint; partly worn. Incised, graphical signs on handle. Height 22.5.
75. Levanto-Helladic bowl, as No. 18, but with a band of N-shaped ornaments inside rim. Red, slightly lustrous paint. Diam. 20.0.
76. Levanto-Helladic goblet with high, narrow stem, and two horizontal handles on rim. Encircling lines around body and stem; two bands of radiating zigzag lines inside. Red, slightly lustrous paint. Diam. 11.0.
77. Levanto-Helladic jug, as No. 58, but with two narrow bands of arched lines, framing dotted circles between handles. Incised, graphical signs on one of handles. Red, slightly lustrous paint. Incomplete. Height 28.5.

CHRONOLOGY

The finds of Side-chamber 1 may be considered as contemporary with those from the bottom layer of the Chamber. The overwhelming majority of the pottery of this group consists of Levanto-Helladic Ware. The group has very little connection with exactly datable Cypriote Ware. The proportions between indigenous and imported wares is certainly a chronological indication of importance, pointing to a fairly late date within Late Cypriote II, but another fact must also be kept in mind. The tomb was the richest found by the Expedition, and wealth may have had some influence on the frequency of the imports.

The main types of the Levanto-Helladic pots seem to assign the group to a time after the middle of Late Cypriote II, and the Plain White pots of the Chamber (Nos. 101, 102, 114) agree with this date.

The second group of the Chamber differs considerably from the earlier one. The Levanto-Helladic Ware consists almost exclusively of flat bowls, often painted with mat colours,

Summing up the Object Register and distributing the finds

	Pottery						Bronze										
	Hand-made			Wheel-made			Sword	Spear-heads	Helmet	Chisel	Rings	Anklets	Mirrors	Disc	Jug	Bowls	
	Base-ring II	Wh. Shaved	Wh. Sl. II	Wh. P.	Pl. Wh.	Levanto-Helladic											
Side-chamber I	17 -1 In fragm. 1	20	In fragm. 2	32, 40 -2	4, 5, 6, 7, 18, 19 21, 22, 23, 25, 26, 27 28, 31, 33, 34, 35, 38 41, 43, 44, 45, 46, 47 48, 49, 50, 51, 52, 53 54, 55, 56, 57, 58, 59 60, 61, 62, 63, 64, 65 66, 67, 68, 69, 70, 71 72, 73, 74, 75, 76, 77 -54 In fragm. 16 -70											24 29 42 -3 In fragm. 4 -7	
Chamber 1st group				56 121 -2	100, 101 102, 114 -4	74, 79, 80, 96, 104 123, 124 -7											
Chamber 2nd group	116 117			19 98	25, 54 75, 99 111, 118	18, 26, 32, 34, 35, 49, 70 50, 51, 52, 57, 63, 64 67, 69, 73, 76, 86, 87 110, 113, 115	70	17 66	129	65	30	27 28	16 48	89	120	14, 29 31, 53 55, 71 82, 85 88, 119	-10
	-2	-1	-2	-2	-6	-21	-1	-2	-1	-1	-4	-2	-2	-1	-1		

and the Plain White vase No. 25 reminds us of the advanced shapes found in Tombs 14, 15, and 16. The group is thereby approximately assigned to the end of Late Cypriote II.

TOMBS 19 (Figs. 212; 213: 1-4; 214)

SIZE

	Length	Width	Depth	Height
Dromos A	0.85	1.02	1.08	—
Stomion A	0.15	0.82	—	0.61
Dromos B	1.90	0.84	1.01	—
Stomion B	0.33	0.62	—	0.52
Chamber	3.62	2.88	—	1.18
Tomb 19 A	1.85	1.10	0.30	—

SHAPE

This tomb is, like Tomb 13, a fusion of two tombs which have functioned as a single one. Two dromoi lead down to the common chamber, one in the S. end (Dromos A) and one

between the different periods, we obtain the following diagram:—

Silver		G o l d										Fai- ence	Glass	Stone	Bone	I v o r y					Ostrich egg			
Bracelets	Bowl	Hair-rings	Earrings	Finger-rings	Toe-rings	Diadems	Mouth-pieces	Bead	Necklace	Pin head	Bowl	Bottles	Bowls	Pestles	Disc	Discs	Buttons	Boxes	Pin	Comb	Varia			
		8	3	2	14	1	16																	
		13	9	11		10						30												36
		13	9									37												
		39	12																					
		39	12																					
			15																					
			15																					
		-5	-7	-2	-1	-2	-1					-2												-1
	105	103				95	81, 93					122				83, 83		128						126
	-1	-1				106	94					125				127								-1
						-2	-3					-2				-3		-1						-1
58		7	9, 9	5	23	1	3, 4	42	20	44	68	77	15	15	109	6, 12	43	39	33	13			90	
78		7	10	40	24	2	21					108	36	72		38, 41	91						92	
		8	10	62		61	22						84	97		45, 46	92						107	
		8	11				37						97	112										
			11				60						112											
-2		-4	-6	-3	-2	-3	-6	-1	-1	-1	-1	-2	-5	-4	-1	-6	-3	-1	-1	-1	-1			-3

in the N. end (Dromos B). The former is a small, roughly square shaft with rounded corners, sunk perpendicularly in the rock. The floor slopes gently towards the entrance which was closed by a very solid door-packing. It consisted of two vertical jambs and a central slab, wedged with some small stones, and was found *in situ*. The stomion is short and wide, and leads by means of a perpendicular step down to the chamber. The step is cased in small, square stones.

Dromos B is an oblong shaft with rounded corners. It widens towards the entrance of the chamber, and its narrow end is provided with three steps leading from the edge of the natural rock down to the deepest point of the dromos in front of the doorway. This opens from the end of the right-hand wall in a direction at right angles to that of the longitudinal axis of the dromos. This is a feature which also has close parallels in the arrangement of Dromos B of Tomb 13. The door-packing of the entrance consisted of a single slab of heavy, calcareous limestone, which was found drawn backwards. The stomion was, thus, left entirely free. It is a short passage ending in a vertical step, consisting of a single stone.

The shape of the chamber is irregular. Stomion A is placed in a corner between a straight and a curved section of the walls. The prolongation of the stomion, therefore, does not

cross the central area of the chamber. Stomion B continues in a funnel-shaped corridor which widens gently towards the chamber, a very unusual feature among the tombs of Enkomi. The floor is roughly horizontal, and walls and roof form a low, arched vault. To decide which of the two entrances was the original one, or to reconstruct the shape of the first chamber, can only be a matter of conjecture.

Tomb 19 A is a shallow, rectangular shaft lying parallel to Dromos B. It is dug in the earth, and lined with a thick layer of limestone material and gravel.

STRATIFICATION

Dromos A was filled by a uniform layer of *chavara*, and was entirely built over by massive Byzantine masonry, which had to be broken through in order to clear the space. These Byzantine constructions were also found when Dromos B was excavated. On the S. edge was founded a wall of dressed poros blocks, reaching a maximum height of approx. 1.30 m. Above Stomion B the wall was preserved to a height of about 1.00 m. Along the N. side of the wall — i. e., above Dromos B — was dug a foundation trench, filled with refuse from the cutting of the sandstone blocks, gravel, fragments of tiles, and decomposed red mud-bricks. The Byzantine workmen found the tomb, and sacked it, whereafter the pit was refilled, and the floor of the building was laid on top of the dromos on a level with the second row of large stones. Tomb 19 A was never found, and was, consequently, left intact. On a bed of limestone material lay the burial stratum, which was covered by fine sand up to the edge of the shaft. On top of the shaft was a slightly curved layer of rocky matter and ordinary field-earth, which at its S. end rested on the remains of the original filling of Dromos B. From this circumstance it can be gathered that Tomb 19 A is later than the last burial which took place through Dromos B.

The interior stratification of the tomb showed distinct traces of the robbery. On the surface of the filling lay finds* and skeletal remains in great disorder. Some of the gold objects had escaped the attention of the robbers, but some had certainly been taken off. It is evident that the chamber has contained two different burial strata, separated by a layer of *chavara*, but this separating layer had been dug through in several spots, especially along the walls of the chamber, and the contents of the two strata disturbed, and partly mixed. A definite distribution of the finds between the two periods is, for this reason, rendered impossible. Moreover, the bottom layer was very wet and silted, so that the finds had been partly disturbed even before the operations of the robbers. When, in the following classification, it is necessary to treat the contents of the tomb as a single group, it is worth bearing in mind that this group is the result of a confusion of two different strata.

BURIALS

On the surface of the earth-filling in the chamber lay the scattered remains of six skeletons. None of them was left *in situ* and their original positions can, therefore, not be made out for certain. In the silted layer below the stratum of *chavara* were found remains of eleven

* These finds are given in the Object Register below without levels, and are marked by the definition: Surface.

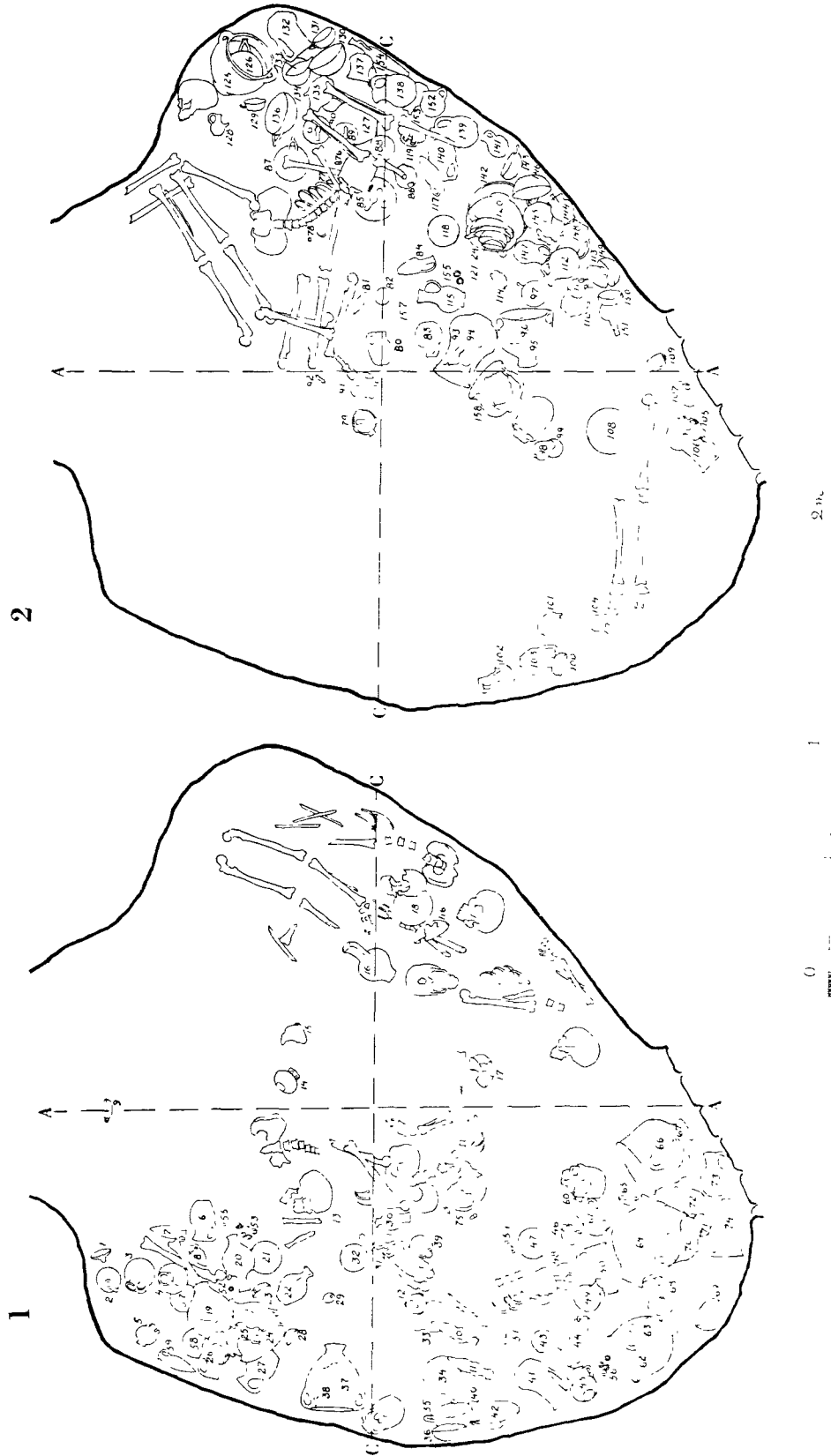

Fig. 212. Enkomi. Tomb 19, Finds *in situ* (1, 2).

other bodies. The bones and the deposits have been disturbed both by water and by the Byzantine intruders. Although no skeletons were perfectly preserved, a general similarity in their positions is worth noting. In five cases it could be stated that the legs had been outstretched. This is, of course, a strong indication that the bodies have been deposited in dorsal, outstretched positions, and, as a matter of fact, the best preserved skeleton of this lower layer was found in such a position. It was lying with its feet towards Stomion B in the E. part of the chamber. The legs were slightly bent at the knees, but that seems to be due to some alterations carried out in connection with a later burial. Femora and tibiae were lying dorsally, as well as the trunk of the body and the skull. The rest of the skeletons are too poorly preserved, to allow of any certain conclusions as regards their original positions.

In Tomb 19 A three skeletons were buried in outstretched, dorsal positions. One of them was a boy's skeleton, lying partly on top of a male body. The feet of the latter were crossed, and the head had fallen over towards the third skeleton, which belonged to an adult woman.

FINDS (GROUPS: PLS. XCI, XCII; TYPES: L. OF PL. II)

Chamber

1. Base-ring II conical bowl with concave, angular outline; raised rim, and an arched wish-bone handle below rim. Handle missing. Diam. 9.6. Floor.
2. Base-ring II oval jug with a ridge between neck and shoulder; cylindrical neck; stilted rim, and handle from rim to shoulder. Longitudinal axis leans backwards. Height 12.2. Floor.
3. Plain White Wheel-made oval jug with base-ring; tall, concave neck; stilted rim, and handle from rim to shoulder. Base-ring chipped. Height 23.5. Floor.
4. Plain White Wheel-made depressed oval, slightly biconical jug with flat base; concave, splaying neck; plain rim, and handle from rim to shoulder. Height 19.7. Floor.
5. Levanto-Helladic squat stirrup-vase with angular outline. Encircling lines around shoulder, necks, belly, and base; painted handles, and winged lozenges on shoulder. Lustrous paint; surface worn. Height 10.7. Floor.
6. Plain White Wheel-made jug, as No. 4, but with pinched mouth. Height 17.5. Floor.
7. White Shaved bobbin-shaped bottle with pointed base; concave neck; splaying rim; somewhat pinched mouth, and handle from rim to shoulder. Height 16.7. Floor.
8. White Shaved bottle, as No. 7. Rim chipped. Height 18.3. Floor.
9. Levanto-Helladic shallow bowl with base-ring, and handle from rim to body. Encircling lines around rim, body, and base; an encircled spiral inside. Diam. 8.7. Floor.
10. Idol of terracotta with flat, triangular head; large, almost horizontal ears; huge, triangular nose, and button-shaped eyes in relief; small, conical breasts; small hands of conventionalized type; sexual parts marked by a large triangle; wide pelvis; tapering legs. The feet rest only on the toes. A hole for umbilicus. Black hair, eyes, ears, and sexual parts. Height 21.6. Surface.
11. Idol of terracotta, as No. 10. Height 20.3. Surface.
12. Shallow stone bowl with pestle; round base, and three feet, ornamented with incised lines. The pestle has the shape of a truncated cone with convex base. Diam. 8.2. Surface.
13. Plain finger-ring of gold. Diam. 2.0. Floor.
14. Levanto-Helladic squat, round stirrup-vase with base-ring. Encircling lines around shoulder, necks, belly, and base. Much worn; lustrous paint. Height 10.3. Surface.
15. Shallow bronze bowl with round base and thickened rim. Badly corroded. Diam. c. 17.0. Surface.
16. Levanto-Helladic oval jug with base-ring; wide shoulder; tall, concave neck; splaying, thick rim, and handle from rim to base. Encircling lines round rim, between neck and shoulder, and around belly, body, and base; a frieze of running spirals on shoulder. Mat paint. Height 24.0. Surface.
17. Bronze bowl, as No. 15. Very badly corroded. Diam. 15.7. Surface.
18. Levanto-Helladic shallow bowl with base-ring, and a horizontal handle at rim. Encircling lines around rim, body, and base; an encircled spiral inside. Rim smashed. Mat paint. Diam. 17.2. Surface.
19. Plain White Wheel-made jug, as No. 3. Rim and handle missing. Incomplete. Height c. 36.0. Surface.
20. Levanto-Helladic oval jug with narrow, raised base; concave neck; thickened rim, and three small, vertical handles on shoulder. Painted neck, base, and handles; encircling lines around shoulder and belly, and a band of scale-pattern between handles; transverse

- lines on rim. Base chipped. Lustrous paint. Height 25.4. Surface.
21. Red Slip Wheel-made conical, wide bowl with round base; straight sides, and plain rim. No handle; thin ware. Suggesting a bronze bowl as prototype. Diam. 14.6. Floor.
 22. Plain White Wheel-made jug, as No. 6, but with pinched mouth. Height 19.1. Floor.
 23. Levanto-Helladic bowl, as No. 9. Mat paint. Diam. 8.9. Floor.
 24. Levanto-Helladic wide crater with base-ring; straight sides, and flat rim. Two horizontal handles on body. Encircling lines around rim, belly, body, and base; painted handles; between handles a frieze of grazing bulls and goats among tall flowers. Lustrous paint. Height 28.7. Floor.
 25. White Slip II shallow bowl with round base; bent-in rim, and a triangular wish-bone handle below rim. Bands of parallel lines around rim; transverse lines on handle, and vertical bands of parallel lines from rim to base. Diam. 12.6. Found in No. 24.
 26. Plain White Wheel-made jug, as No. 6. Height 21.5. Floor.
 27. Plain White Wheel-made jug, as No. 4. Height 20.5. Floor.
 28. Plain White Wheel-made shallow bowl with flat base; rounded sides, and straight rim. Rim pierced by two holes. Diam. 8.8. Floor.
 29. Ovoid mace-head of hard, grey stone with a tapering hole through the longitudinal axis. Diam. 6.6. Floor.
 30. Levanto-Helladic jug, as No. 20, but with horizontal handles, and with a band of network-pattern between handles. Piece of base missing. Lustrous paint. Height 15.3. Floor.
 31. Levanto-Helladic squat, rounded stirrup-vase with flat base. Encircling lines around body and neck. Paint worn. Lustrous paint. Height 9.0. Floor.
 32. Plain White Wheel-made shallow bowl with base-ring; plain rim, and an oblong string-hole projection at rim. Projection missing. Diam. 12.3. Floor.
 33. Plain White Wheel-made bowl, as No. 28, but with horizontal handle, and no holes. Diam. 14.2. Floor.
 34. White Slip II bowl, as No. 25. Diam. 16.1. Floor.
 35. White Slip II bowl, as No. 25, but deeper. A band of ladder-pattern around rim; vertical stripes of the same pattern, alternating with dotted lines from rim to base; transverse lines on handle. Diam. 18.6. Floor.
 36. Bronze bowl, as No. 15. Badly corroded. Diam. 15.5. Found on top of No. 35.
 37. Plain White Wheel-made wide crater with base-ring; wide, short, tapering neck; flat rim, and two handles from rim to shoulder. Height 27.9. Floor.
 38. Base-ring II bowl, as No. 1. Diam. 17.2. Found on top of No. 37.
 39. Levanto-Helladic globular jug with base-ring; narrow, concave neck; splaying rim, and two handles from neck to shoulder. Encircling lines around rim, neck, shoulder, belly, and base; groups of chevrons on shoulder. Base-ring missing. Lustrous paint; surface worn. Height 10.3. Floor.
 40. Plain White Wheel-made cup-shaped bowl with rounded base; tapering sides; splaying rim, and handle from rim to body. Diam. 9.2. Found on top of No. 42.
 41. Bichrome Wheel-made squat jug with base-ring; concave neck; slightly splaying rim, and handle from rim to shoulder. Horizontal lines around rim, between neck and shoulder, and around belly; a frieze of alternating groups of parallel, oblique lines on the shoulder; framed, broad bands from rim to shoulder, containing a vertical herring-bone pattern with a central line, suggesting an elementary tree-ornament. Paint worn. Height 24.1. Floor.
 42. Plain White Wheel-made flat, shallow bowl with base-ring; thickening rim, and a horizontal string-hole projection at rim. Diam. 23.3. Floor.
 43. White Painted V globular jug with flattened base; tapering neck; raised, pinched mouth, and handle from neck to shoulder. Horizontal lines around neck and belly; broad bands of vertical strokes from neck to belly, and from belly to base. Height 13.3. Floor.
 44. Red Polished IV, almost hemispherical bowl with round base; a semicircular spout at rim, and a horizontal handle opposite the spout. Diam. 24.5. Floor.
 45. White Painted Wheel-made jug, as No. 41. Small transverse lines around rim; a framed, wavy line below rim, and around belly; horizontal lines between neck and shoulder; a frieze of alternating groups of parallel, oblique lines on shoulder; framed, broad bands from rim to shoulder, containing parallel, oblique lines; chess-board patterns, and tree-ornaments of the same type as No. 41; parallel, oblique lines on handle. Height 21.5. Floor.
 46. Levanto-Helladic deep, cup-shaped bowl with narrow base-ring; concave sides, and handle from rim to body. Encircling lines around rim, body, and base. Mat paint; worn. Height 8.0. Floor.
 47. Plain White Wheel-made flat, shallow bowl with flat base; raised, slightly bent-in rim, and a string-hole projection at rim. Diam. 13.4. Floor.
 48. Plain White Wheel-made jug, as No. 22. Height 16.4. Floor.
 49. Plain White Wheel-made jug, as No. 4. Height 16.7. Found on top of No. 50.
 50. White Painted Wheel-made jug, as No. 41; neck decorated with framed, wavy, vertical lines, and parallel, oblique lines. Height 22.3. Floor.
 51. Earring of gold. A thin circular wire with overlapping ends to which is attached a hollow pendant in the shape of a conventionalized ox-head. The ears are marked by round pellets; on the forehead is a vertical, double spiral; head covered with a scale-pattern. Enchased work. Length 3.6. Surface.
 52. Plain, spiral hair-ring of gold. Diam. c. 2.1. Floor.
 53. Three pairs of crescent-shaped earrings of bronze. Diam. 2.2. Floor.

54. Spiral bracelet of silver; in five pieces. Diam. 6.3. Surface.
55. White, fluted paste bead. Floor.
56. Four hair-rings of bronze with overlapping ends. Diam. 1.7. Surface.
57. White Slip II bowl, as No. 25. Diam. 12.2. Floor.
58. Plain White Wheel-made shallow bowl with flat base; rounded sides; straight rim, and a very small, horizontal handle at rim. Diam. 13.2. Floor.
59. White Shaved bottle, as No. 7. Height 18.0. Floor.
60. White Painted IV oval jug with round base; concave neck; straight rim, and handle from rim to shoulder. Horizontal lines around neck, and crossed bands of parallel lines on body. Height 10.5. Floor.
61. White Painted Wheel-made jug, as No. 41. A framed, wavy line around rim and belly; parallel, oblique lines on handle; neck and shoulder decorated as No. 41. Between the bands on neck, a large ornament of two lattice triangles, arranged like a double-axe with central staff. A ridge between neck and shoulder. Height 19.7. Floor.
62. Levanto-Helladic wide crater with base-ring; straight sides; flat rim, and two horizontal handles on body. Encircling line around rim, belly, body, and base; two bands of running spirals between handles. Lustrous paint. Height c. 25.0. Surface.
63. White Slip II bowl, as No. 25. Diam. 12.8. Found in No. 62.
64. Plain White Wheel-made large, oval crater on low stem; wide, concave neck; flat rim; a ridge between neck and shoulder, and two indented handles from rim to shoulder. Height 36.6. Surface.
65. Levanto-Helladic shallow bowl with base-ring, and a horizontal handle at rim. Encircling lines around rim, body, and base; concentric circles inside; painted handle. Lustrous paint. Diam. 7.7. Surface.
66. Levanto-Helladic wide crater with base-ring; straight sides; flat rim, and two horizontal handles on body. Encircling lines around rim, belly, body, and base; painted handles; between the handles, a frieze of grazing bulls and goats among tall flowers. Lustrous paint. Height 27.0. Surface.
67. Levanto-Helladic bowl, as No. 65, but with curved sides; splaying rim, and handle from rim to body; decorated as No. 65. Lustrous paint. Diam. 13.2. Found in No. 66.
68. White Painted V squat, biconical jug with flat base; wide, tall, cylindrical neck; somewhat splaying rim, and handle from rim to shoulder. Horizontal lines around rim, neck, belly, and base; large lattice-triangles around neck; broad bands of vertical lines from neck to belly, and similar decoration from belly to base. Rim chipped; handle missing; paint worn. Height 16.1. Floor.
69. White Slip II bowl, as No. 35. Diam. 15.7. Floor.
70. White Painted Wheel-made squat jug with base-ring; wide, tapering neck; slightly splaying rim, and handle from rim to shoulder. Encircling lines around rim and belly; oblique lines on handle; broad bands of framed, parallel, oblique lines, and vertical lines from rim to belly. Height 18.8. Floor.
71. Monochrome shallow bowl with flat base; in-turned, distinct rim, and a wish-bone handle below rim. Diam. 10.7. Floor.
72. Black Slip Wheel-made oval jug with flat base; ridge between neck and shoulder; somewhat splaying neck; pinched mouth, and handle from rim to shoulder. Rim repaired. Height 18.0. Floor.
73. Black Slip Wheel-made jug, as No. 72. Height 19.6. Floor.
74. White Painted Wheel-made jug, as No. 41. A framed, wavy line around rim and belly; shoulder ornament as No. 41, but containing also parallel, oblique lines, and framed, wavy lines. A ridge between neck and shoulder. Piece of rim missing; paint worn. Height 24.8. Floor.
75. A pair of earrings of gold, as No. 51; heads covered with conventional designs of half decorative, half naturalistic effect. Rather worn. Length 3.4. Surface.
76. A pair of earrings of gold as No. 51; heads covered with a more elaborate design of a volute palmette above a double volute. A twisted ring at the pointed end. Length 3.4. Floor.
77. Mouth-piece of plain gold leaf with curved sides; rounded ends pierced by holes; lips conventionally marked by two thin, enched lines. Length 9.5. Floor.
78. Flat, circular finger-ring of gold, composed of twisted wires alternating with plain ones; smooth inner side. An oval bezel of a white faience scarab with visible wing-cases; bezel surrounded by the same sort of filigree work. Diam. 2.1. Floor.
79. Stone bowl with pestle, as No. 12. On the edge of the bowl is the protome of a bull with incisions on eyes and forehead. Rim and sides of bowl decorated with zigzag lines; legs, with crossed lines. Diam. 10.6. Length of pestle 4.6. Floor.
80. Plain White Wheel-made jug, as No. 4. Height 14.4. Floor.
81. White Painted V bobbin-shaped rattle with pointed base; concave neck; ending in an owl-shaped head; handle from top of head to shoulder. Horizontal lines around neck, and vertical lines on body. In the rattle is a small ball of clay. Height 10.7. Floor.
83. Plain White Wheel-made jug, as No. 4. Height 15.2. Floor.
82. Levanto-Helladic bowl, as No. 46, but with an encircled spiral inside. Mat paint. Diam. 7.7. Floor.
84. Plain White Wheel-made narrow bottle with flat base; distinct shoulder; narrow, cylindrical neck; splaying rim; pinched mouth, and handle from rim to shoulder. Height 17.2. Floor.
85. Levanto-Helladic globular stirrup-vase with base-ring. Encircling lines around shoulder, neck, belly, and base;

- an encircled dot on the knob; dotted stars on shoulder; a wavy line just above belly. Lustrous paint. Height 21.2. Floor.
86. Plain White Wheel-made bowl, as No. 32. Diam. 12.3. Floor.
87. White Slip II bowl, as No. 25. Diam. 15.5. Floor.
88. Levanto-Helladic bowl, as No. 67; decorated as No. 65. Handle missing. Lustrous paint. Diam. 11.0. Floor.
89. Levanto-Helladic depressed, globular stirrup-vase with base-ring. Encircling lines around shoulder, neck, belly, and base; an encircled dot on the knob, and a *fleur de lys* ornament on shoulder. Lustrous paint. Diam. 10.3. Floor.
90. Levanto-Helladic stirrup-vase, as No. 89, but with semicircular, hatched bands as shoulder ornament. Height 11.7. Floor.
91. Bronze mirror with ivory handle. The handle is made in the shape of a strictly frontal and symmetrical, nude, female figure of slender type with round face, supporting her breasts with her hands. The hair is dressed in the short-cut Egyptian fashion with no adornments, and the eyes have been inlaid with other material. The mounting to which the mirror was fitted, is a square plaque ornamented on the back with an animal-scene in incised work. The representation is, however, almost worn out. The mirror is circular, and very badly damaged. Feet of figurine missing; surface worn. Total length of handle 11.7. Height of figurine 8.5. Floor.
92. Bronze chisel with ivory handle. Oval, cylindrical handle with fork-shaped top suggesting a lotus-element. The chisel is entirely corroded. Length of handle 5.2. Floor.
93. Plain White Wheel-made amphora with base-ring; tall, wide, cylindrical neck; flaring rim, and two vertical handles on neck. Height 29.5. Surface.
94. White Slip II bowl, as No. 25; handle missing. Diam. 12.2. Found in No. 93.
95. Plain White Wheel-made wide crater with base-ring; wide, short, tapering neck; flat rim, and two handles from rim to shoulder. Diam. 21.0. Floor.
96. White Slip II bowl, as No. 25. Diam. 17.7. Floor.
97. Levanto-Helladic bowl, as No. 67, decorated as No. 65, but with an encircled spiral inside. Lustrous paint. Diam. 12.0. Surface.
98. Levanto-Helladic stirrup-vase, as No. 5. Encircling lines around shoulder, necks, belly, and base; rest of decoration obliterated. Necks and handles missing. Lustrous paint. Height 10.2. Surface.
99. Levanto-Helladic bowl, as No. 9. Mat paint. Diam. 9.0. Surface.
100. Plain White Wheel-made shallow bowl with flat base; rounded sides, and straight rim. Rim pierced by two holes. Diam. 11.3. Found on top of No. 103.
101. Monochrome bowl, as No. 71, but with slightly out-bent edge. Handle broken. Diam. 11.9. Floor.
102. White Painted Wheel-made jug, as No. 45. Horizontal lines around rim, neck, and belly; bands of vertical lines on neck and shoulder, and transverse lines on handle. Paint much worn; piece of neck missing. Height 15.5. Floor.
103. Plain White Wheel-made jug, as No. 6. Height 17.4. Floor.
104. Monochrome globular jug with flat base; tall, tapering neck; splaying rim; raised, somewhat pinched mouth, and handle from neck to shoulder. Height 11.3. Floor.
105. Base-ring I depressed jug with wide neck; flat rim; handle from rim to shoulder, and a large, knobbed projection at rim where handle starts; two ridges around neck. Height 8.2. Found on top of No. 106.
106. White Painted Wheel-made jug, as No. 41; decorated as No. 74, but with framed lattice triangles on neck. A ridge between neck and shoulder. Height 24.4. Floor.
107. Monochrome jug, as No. 104. Height 12.9. Floor.
108. Plain White Wheel-made shallow bowl with base-ring; raised, slightly bent-in rim, and an oblong string-hole projection at rim. Diam. 20.6. Floor.
109. Levanto-Helladic bowl, as No. 46, but with a circle inside. Mat paint. Height 5.9. Surface.
110. Base-ring II oval jug. Bands of white lines on body. Neck and handle missing. Height 16.4. Floor.
111. Levanto-Helladic jug, as No. 39, but without shoulder ornament. Height 11.6. Found on top of No. 110.
112. Plain White Wheel-made jug, as No. 4. Height 18.5. Found on top of No. 148.
113. Plain White Wheel-made bowl, as No. 108. Diam. 12.3. Floor.
114. Levanto-Helladic bowl, as No. 9; but with an encircled spiral inside. Mat paint. Diam. 9.3. Surface.
115. Base-ring II jug, as No. 2, but with tall, splaying neck, and handle from neck to shoulder. Bands of white lines on neck and body. Height 20.0. Floor.
116. Bronze bowl, as No. 15. Badly corroded. Diam. c. 19.0. Surface.
117. White Shaved bottle, as No. 7. Height 18.8. Surface.
118. White Slip II bowl, as No. 25. Diam. 14.0. Floor.
119. Levanto-Helladic angular, squat stirrup-vase with base-ring. Decorated as No. 89, but with a band of zigzag elements around belly; curved and dotted lines as shoulder ornaments. Worn, lustrous paint. Height 10.0. Floor.
120. Plain White Wheel-made crater, as No. 37, but with straight rim, and indented base. Height 23.2. Found on top of No. 142.
121. Bronze bowl, as No. 15. Diam. c. 19.0. Found in No. 120.
122. Base-ring II bowl, as No. 1. Diam. 16.0. Found in No. 121.
123. White Slip II bowl, as No. 25; handle missing. Diam. 13.2. Found in No. 122.
124. Levanto-Helladic shallow bowl with base-ring, and a horizontal handle at rim. Encircling lines around

- rim, body, and base; an encircled spiral inside. Diam. 10.2. Found in No. 123.
125. Plain White Wheel-made crater, as No. 37. Height 29.3. Floor.
126. Base-ring II bowl, as No. 1. Diam. 17.7. Found in No. 125.
127. Plain White Wheel-made oval jug with wide, flat base; an impressed line between neck and shoulder; concave neck, and handle from rim to shoulder. Rim chipped. Height 28.2. Floor.
128. White Painted Wheel-made depressed, globular jug with flat base; concave neck; splaying, thick rim; handle from rim to shoulder, and a tubular spout on shoulder opposite the handle. Horizontal lines around rim and neck; black handle, and vertical lines from neck to base. Height 9.0. Floor.
129. Levanto-Helladic bowl, as No. 9. Rim and handle chipped. Diam. 9.8. Surface.
130. White Slip II bowl, as No. 25. A band of ladder-pattern around rim; similar vertical stripes, alternating with dotted lines, from rim to base; transverse lines on handle. Diam. 18.5. Surface.
131. Monochrome bowl, as No. 71. Diam. 10.4. Floor.
132. Bichrome Wheel-made squat jug with base-ring; wide, tapering neck; slightly splaying rim, and handle from rim to shoulder. A dotted line on rim; encircling lines around rim, neck, and belly; vertical bands of broad and thin lines from rim to belly; oblique lines on handle. Piece of rim missing. Height 20.6. Floor.
133. White Shaved bottle, as No. 7. Height 14.3. Found in No. 134.
134. Monochrome bowl, as No. 71. Rim chipped. Diam. 11.8. Floor.
135. Black Slip Wheel-made jug, as No. 72, but without ridge. Neck and handle missing. Height 15.5. Floor.
136. White Slip II bowl, as No. 25; decorated as No. 130. Diam. 19.0. Floor.
137. Base-ring I jug, as No. 105. A wavy relief-line around shoulder. Height 10.9. Floor.
138. Plain White Wheel-made jug, as No. 4. Height 19.2. Surface.
139. Bichrome Wheel-made globular jug with flat base; cylindrical neck with handle-ridge, and handle from neck to shoulder. A horizontal line around neck; horizontal and oblique bands from neck to base, forming an irregular network. Each band consists of a central, red line, and two framing, grey lines. Height 21.0. Surface.
140. Black Slip Wheel-made jug, as No. 35. Rim chipped. Height 18.2. Floor.
141. Plain White Wheel-made jug, as No. 6. Height 12.5. Surface.
142. Plain White Wheel-made bowl, as No. 42, but without string-hole projection. Diam. 27.7. Floor.
143. Monochrome bowl, as No. 71. Diam. 12.2. Floor.
144. Base-ring I oval jug, mainly as No. 105, but with oval body, and short neck. Oblique bands of parallel lines in white paint on neck and shoulder. Height 12.0. Found on top of No. 145.
145. White Painted V jug, as No. 68; decoration similar to that of No. 68, but with lattice lozenges around neck, and oblique bands of parallel lines on shoulder. Piece of neck and handle missing. Height 19.3. Found in No. 146.
146. White Slip I hemispherical bowl with round base; in-turned rim, and a rounded wish-bone handle below rim. A wavy line and a band of minute ladder-pattern around rim; vertical bands of similar pattern, alternating with small lattice lozenges, hanging from rim; a front-ornament, repeated below the handle, of the same design together with wavy lines and dots; pairs of dots below rim; transverse lines on handle. Diam. 17.7. Floor.
147. Black Slip II oval jug with flat base, tapering neck; small, splaying rim, and raised handle from rim to shoulder. Surface worn. Height 15.0. Floor.
148. White Slip I depressed jug with base-ring; very wide, concave neck; sharp, flat rim; handle from rim to shoulder; a large projection on rim at spring of handle, and a hooked knob opposite the handle. Body covered with an almost faded, very loose network-pattern of parallel, wavy lines, running in horizontal and vertical directions. A broader band of parallel, oblique lines around belly. Longitudinal axis tilted backwards. Height 14.9. Floor.
149. White Slip II shallow bowl with flattened base; out-turned rim, and a horizontal handle partly cut out of, partly raised above rim. Diam. 13.6. Floor.
150. Monochrome bowl, as No. 101. Handle missing. Diam. 10.4. Floor.
151. Base-ring I lentoid bottle with narrow, cylindrical neck; splaying rim, and handle from neck to body; a ridge around neck, and crossed bands of parallel lines on body. Height 15.0. Floor.
152. White Painted V globular jug with flattened base; very wide, cylindrical neck, and a somewhat raised handle from rim to shoulder. Encircling lines around neck and belly; oblique bands of parallel lines on shoulder; similar vertical bands from belly to base. Height 11.3. Floor.
153. Black Slip II oval jug with flat base; cylindrical neck; splaying rim; pinched mouth, and handle from rim to shoulder. Surface worn. Height 14.7. Floor.
154. Red Lustrous Wheel-made tall, narrow bottle with base-ring; slanting shoulders; tall, tapering neck; wide, thick rim, and handle from neck to shoulder. Height 29.4. Floor.
155. Two hair-rings of gold, as No. 52. Diam. 3.1. Floor.
156. Two plain, circular rings of bronze. Diam. 3.2; 2.5. Found in the sieves.
157. Shallow bowl of faience with round base, and plain rim. Black dots on rim; yellow inside, and light-blue outside. Diam. 9.8. Floor.

CHRONOLOGY

The contents of the tomb and the conditions under which they were found very much resemble those of Tomb 13. The great amount of Middle Cypriote Ware points to the Late Cypriote I period for the first burials, but to separate the finds belonging to this period from the rest of the contents is impossible by means of stratigraphical methods alone. The tomb seems to have been in use more or less permanently to about the middle of Late Cypriote II, to which epoch the latest finds can be assigned.

Tomb 19 A is one of the typical earth-tombs of Late Cypriote III.

TOMB 20 (Fig. 213: 5—7)

	SIZE			
	Length	Width	Depth	Height
Dromos	1.13	1.05	1.08	—
Stomion	0.35	0.78	—	c. 0.65
Chamber	1.60	2.13	—	c. 1.60

SHAPE

The dromos of this tomb was originally an almost circular shaft tapering downwards. Evidently intending to hollow out another chamber opposite the actual one, the back wall of the dromos has been cut out to form an undermined cavity, but for some reason the intention was never carried through.

The chamber opens from the S. end of the dromos, and was closed by a single block of heavy, calcareous stone. Stomion and chamber had fallen in, but their heights could be satisfactorily reconstructed. The chamber is roughly circular with curved walls and roof, and a circular, central basin, sunk in the rock. Around this basin remains a narrow ledge in the shape of a shelf cut along the walls. The threshold of the stomion lies 0.90 m. above the shelf, and slopes abruptly down to the lower level. Thus, the chamber becomes almost hive-shaped with the entrance from the top of the roof.

STRATIFICATION

Immediately above the tomb was a thick layer of Byzantine debris which had intruded in both chamber and dromos. It contained large building stones, fragments of mud-brick, plaster, and tiles. The rest of the dromos-filling consisted of *chavara*, stratified in two horizontal, intact layers. In the chamber was a layer of rock debris from roof and walls, a fan-shaped stratum of greenish clay which had flowed down from the doorway, and, finally, a burial stratum covered by silted clay and rock debris. The burial layer rested directly on the floor, and on the ledge.

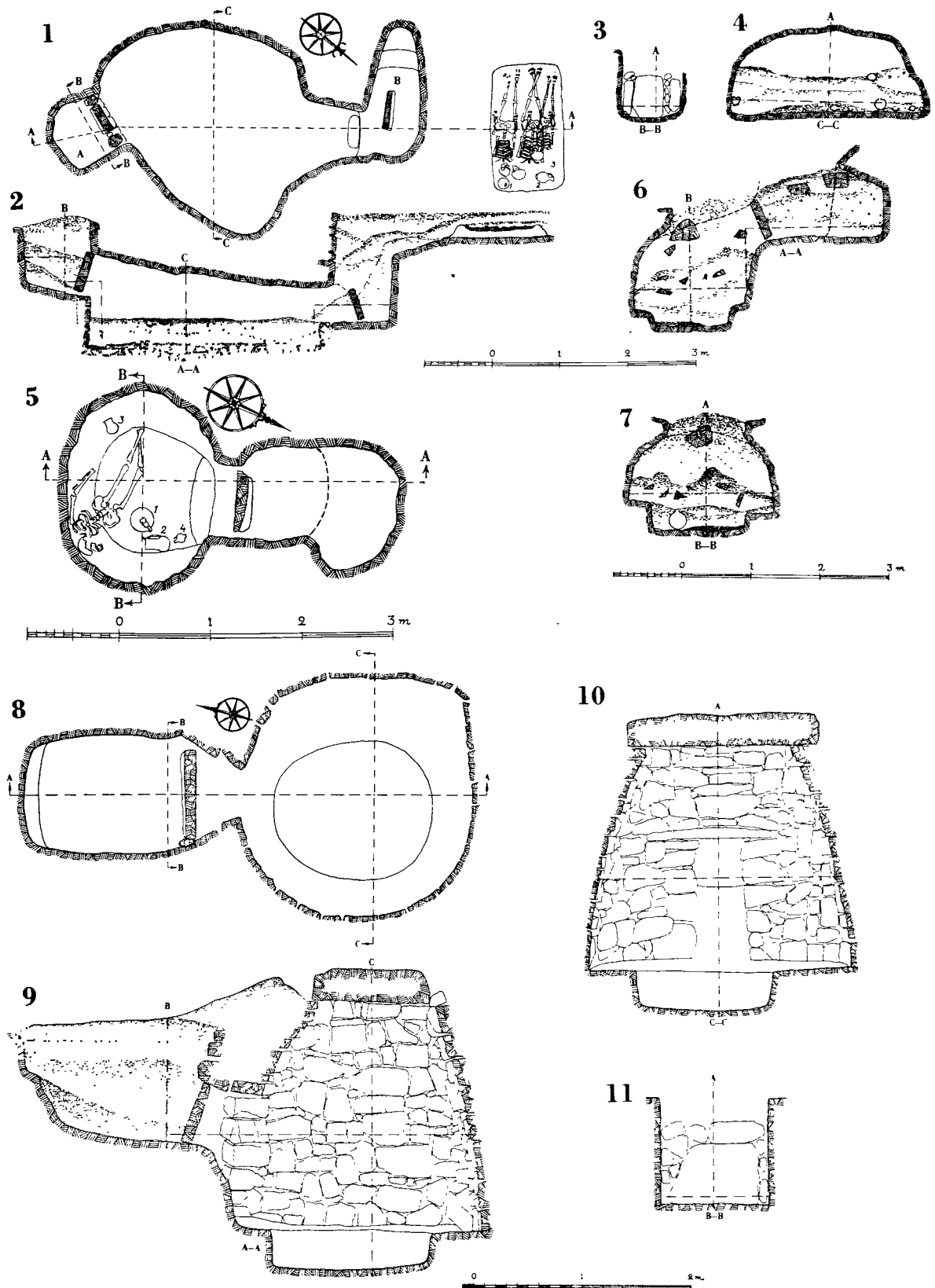

Fig. 213. Enkomi. Tomb 19, Plan (1); Sections A—A, B—B, C—C (2, 3, 4). Tomb 20, Plan (5); Sections A—A, B—B (6, 7). Tomb 21, Plan (8); Sections A—A, C—C, B—B (9, 10, 11).

BURIALS

Only one burial had taken place in the chamber. The skeletal remains were fairly well preserved, and the original position of the body was easy to see. It had been seated on the ledge opposite the door with its feet in the central basin. It was surrounded by a few pots, one of which was placed on the ledge.

FINDS (GROUP: PL. LXXXVII, 3; TYPES: L. OF PL. II)

- | | |
|---|---|
| <p>1. Red Slip Wheel-made globular jug with round base; cylindrical neck; splaying rim, and handle from neck to shoulder. Pieces of neck and rim missing. Height 34.1. Floor.</p> <p>2. White Painted IV squat jug with round base; wide, cylindrical neck; stilted rim; handle from rim to shoulder, and a knobbed projection at top of handle. Bands of parallel lines, framed lattice lozenges, and zigzag lines around neck and shoulder; bands of vertical lines from belly to base. Most of the decoration obliterated. Height 28.9. Floor.</p> | <p>3. White Painted V squat jug with round base; wide, concave neck; flaring rim, and two string-holes below rim. Broad, fringed, encircling bands around neck, shoulder, and base; vertical lattice bands on neck; vertical, wavy lines and dots on neck; two groups of antithetic latticed triangles, flanked by parallel, vertical lines on belly; wavy lines and transverse strokes on rim, and crossed, straight lines on base. Height 17.0. Floor.</p> <p>4. Black Lustrous Wheel-made jug with narrow base-ring; narrow neck; wide, flat rim, and handle from neck to shoulder. Punctured zigzag lines on body. Height 15.2.</p> |
|---|---|

Summing up the Object Register, we obtain the following diagram:—

P o t t e r y			
H a n d - m a d e		W h e e l - m a d e	
Wh. P. IV	Wh. P. V	Red Slip	Bl. Lustrous
2	3	1	4
-1	-1	-1	-1

CHRONOLOGY

The finds are few, but sufficient to fix the date. The Red Slip jug No. 1 is of the same ware as the Red Slip Wheel-made sherds found in such abundance below the Iron Age Sanctuary of Ajiros Jakobos (cf. above, p. 369). That layer was datable to Late Cypriote I, and our tomb is thereby assigned to the same epoch. The White Painted IV pot No. 2 shows that the tomb must be assigned to a very early stage of the period concerned.

TOMB 21 (Figs. 213: 8—11; 215)

SIZE

	Length	Width	Depth	Height
Dromos	1.82	1.07	1.02	—
Stomion	0.42	0.43	—	0.53
Chamber	2.26	2.38	—	2.43

SHAPE

The dromos is roughly rectangular with slightly bulging sides, a steep, sloping step near the back wall, and perpendicular long sides. The floor declines gently towards the entrance of the chamber, which was blocked by a large, upright slab of calcareous stone. The jambs were built of small stones and the façade consisted of flat slabs of local limestone, forming regular masonry.

The stomion is a tapering passage, which leads down by means of a steep slope to the level of the chamber floor. The construction of stomion and chamber is peculiar. The chamber is a cylindrical, rock-cut well with a central, shallow basin, surrounded by a ledge, running along the sides of the chamber. The plan thus resembles that of Tomb 20. In this well and projecting above it, the tomb is built according to the scheme of a regular tholos. The material used is local limestone, mixed with blocks of hard, calcareous stone. The latter are used for the interior jambs, the sides of the stomion, the bottom layer close to the entrance, and occasionally in the walls of the chamber. The stones are selected for their purpose and sometimes roughly cut. A sort of dressed masonry was used in the doorway, but the stones in the walls were laid without any distinct system. The masonry is not arranged in clear courses except for the section above the stomion, and no mortar is used. The walls taper upwards in a regular, corbelled vault, and the top stone is an oblong slab of heavy, calcareous stone, measuring 1.78 m. in diameter and 0.30 m. in thickness. The roughly circular hole in the top of the construction is 1.20 m. in diameter, and, consequently, the tapering of the vault is rather slow. The whole structure projects about 1.00 m. above the edge of the natural rock. A comparison between the span of the vault and the height of the construction shows that their interior dimensions are almost identical.

STRATIFICATION

About the stratification of the tomb there is not very much to be said. The dromos was filled with three layers of intact *chavara*, and above these was an oblique stratum of mixed earth and gravel, thickening towards the top of the tholos. This layer had been dug through in modern times and the upper part of the tholos found. That means to say that the Byzantine stratum above the tomb was also penetrated by the modern diggers. A stone was removed from the wall, and the chamber entered and thoroughly sacked. This happened only a few years before our excavation, and I had the opportunity of interviewing some of the men who had taken part in the robbery. They gave unanimous statements that the contents of the tomb was remarkably poor. Only a few fragments of gold leaf and some pots were found in the abundant burial earth. As the modern plunderers generally exaggerate the wealth of the sacked tombs, there seems to be no reason to doubt the truth of their statements in this case. When the tomb was finally excavated by us no finds of any importance were made. A few pots and some boxes of potsherds were all that was brought to light. The filling consisted of burial earth mixed with foreign debris and clay, reaching a maximum thickness of c. 0.70 m. No skeletal remains were left.

Fig. 214. Enkomi. Tomb 19. Finds *in situ*.

Fig. 215. Enkomi. Tomb 21. The stomion seen from within.

It seems certain that the tomb was originally covered by a low tumulus, indicated by the oblique layer above the stomion. The modern robbery has, however, destroyed the conclusive evidence.

FINDS

1. White Painted IV pear-shaped jug with round base; concave, narrow neck; pinched mouth, and handle from neck to shoulder. Encircling lines around neck; oblique, crossed bands of parallel lines from shoulder to base; a vertical, wavy stroke as front ornament; black handle. Rim chipped. Height 13.9.
2. White Shaved bobbin-shaped bottle with pointed base; cylindrical neck; splaying rim; slightly pinched mouth, and handle from rim to shoulder. Pieces of rim and neck missing. Height 14.8.
3. Spherical spindle-whirl of terracotta. Diam. 3.6.
4. Ovoid ball of terracotta. Length 4.7.

Summing up the Object Register we get the following diagram: —

P o t t e r y		T e r r a c o t t a	
H a n d - m a d e			
Wh. P. IV	Wh. Shaved	Spindle-whirl	Ball
1	2	3	4
-1	-1	-1	-1

CHRONOLOGY

The finds given in the Object Register are too few to make a safe basis for the dating of the tomb. Therefore, an analysis of the potsherds was made. It is summed up in the diagram: —

	Hand-made										Wheel-made				Total
	Bl. Sl. II	R.-on-Bl.	Wh. P. IV	Wh. P. V	Wh. Shaved	Pl. Wh.	Monochrome	Base-ring I-II	Wh. Sl. I-II	Pl. Wh.	Bl. Lustrous	Red Lustrous	Red Sl.	Lev.-Hell.	
Number of sherds	11	25	2	3	18	2	122	57	36	38	14	1	2	5	336
Percentage	3.3 %	7.4 %	0.6 %	0.9 %	5.4 %	0.6 %	36.2 %	17.0 %	10.7 %	11.3 %	4.2 %	0.3 %	0.6 %	1.5 %	100 %

This diagram gives full evidence for the period of construction of the tomb. The presence of Black Slip II, Red-on-Black and White Painted IV sherds, together with a relative majority of Monochrome and Base-ring Wares, shows that the tomb was built in the beginning of Late Cypriote I. The few Levanto-Helladic sherds, on the other hand, give evidence that the tomb ceased to be used at the very beginning of Late Cypriote II.

TOMB 22 (Fig. 209: 5—6)

SIZE

	Length	Width	Depth	Height
Dromos	0.95	0.85	0.75	—
Chamber	2.10	1.65	—	1.14

SHAPE

The shape of this tomb is rather unusual in Enkomi, and resembles to a certain extent that of Tomb 1. The dromos is a circular pit, sunk perpendicularly into the rock. The doorway opens from the bottom of the pit and was closed by a circular, flat stone. It joins the chamber from the roof without a stomion as connecting link. The native call this type of tomb by the rather adequate expression, "chimney-tomb". The plan of the chamber is a regular oval with flat floor, walls tapering slightly upwards, and a curved roof. As mentioned above (p. 547) the roof of the chamber was partly destroyed when the dromos of Tomb 18 was cut. The damage was repaired with a stone-packing which, however, could not prevent extraneous earth from intruding into the chamber.

STRATIFICATION

The dromos was filled with a homogeneous layer of *chavara* which gave the impression of being perfectly intact. In the chamber, the stratification was, from the top, as follows:

- 1) A conical layer of mixed foreign earth, emanating from the dromos of Tomb 18.
- 2) A thick stratum of debris from the roof, consisting of *chavara* and large pieces of rock.
- 3) A horizontally silted layer of brown clay.

- 4) A layer of grey, silted clay mixed with some rock debris.
 5) A burial layer, resting directly on the floor.

The Layers 3 and 4 have, evidently, gradually poured into the chamber before the great collapse of the roof, represented by Layer 2. It seems probable that this collapse was a direct consequence of the cutting of the dromos of Tomb 18. The burial stratum represented, apparently, only one burial period.

BURIALS

Diagonally across the floor, lay a fairly well preserved skeleton in outstretched position on its back with its arms along the sides. The skeleton was tall and of male sex. It was surrounded with pots Nos. 1—6 and 8—10. On its right side lay a few remains of a child's skeleton together with the vase No. 7.

FINDS (GROUP: PL. LXXXVII, 4)

- | | |
|---|--|
| <p>1. Plain White Wheel-made shallow bowl with rounded base, and curved sides. Thin ware. Piece of rim missing. Diam. 8.9. Floor.</p> <p>2. Levanto-Helladic squat pyxis with flat base; angular outline; splaying rim, and three horizontal handles on shoulder. Encircling lines around rim and body; concentric circles on base, and a network-pattern between handles. Dark, lustrous paint; worn. Diam. 13.2. Floor.</p> <p>3. Levanto-Helladic shallow bowl with raised base; curved outline, and handle from rim to body. Encircling lines around rim and body; an encircled spiral on bottom. Dark red, mat paint. Diam. 10.3. Floor.</p> <p>4. Levanto-Helladic bowl, as No. 3. Encircling lines outside and inside. Red, lustrous paint. Diam. 10.8. Floor.</p> | <p>5. Black Slip Wheel-made bowl, as No. 1. Brown slip. Diam. 7.7. Floor.</p> <p>6. White Shaved bobbin-shaped bottle with pointed base; concave neck; slightly pinched mouth, and handle from rim to shoulder. Handle missing. Height 16.1. Floor.</p> <p>7. White Shaved bottle, as No. 6. Rim chipped. Height 17.6. Floor.</p> <p>8. Levanto-Helladic bowl, as No. 4. Red, mat paint. Diam. 9.2. Floor.</p> <p>9. Plain White Wheel-made oval amphora with base-ring; wide neck; a ridge below neck; flat rim, and two indented handles from rim to shoulder. Height 33.1. Floor.</p> <p>10. Plain White Wheel-made shallow bowl with flat base; rounded outline, and a horizontal handle below rim. Diam. 11.8. Floor.</p> |
|---|--|

Summing up the Object Register and classifying the pottery in their respective groups, we obtain the following diagram: —

P o t t e r y			
Hand-made		Wheel-made	
Wh. Shaved	Bl. Slip	Pl. Wh.	Lev.-Hell.
6, 7	5	1, 9, 10	2, 3, 4, 8
-2	-1	-3	-4

CHRONOLOGY

The contents of the chamber point unanimously to the middle of Late Cypriote II as the date of the tomb.

SUMMARY

The tombs, except the undatable ones (Nos. 1, 5, and 9), have been dated separately in the previous chapter, and the result is comprised in the table given below. As the majority of the tombs are assigned to Late Cypriote II, and we have been able to place each of them either in the beginning, the middle, or the end of the period concerned, we feel enabled to subdivide the period into three sections, called A, B, and C, thus making the scheme of relative chronology more easily surveyable. This table can be considered as a sequel to the table of the tombs of Ajos Jakovos.

The Roman figures after the numbers of the tombs signify the different burial periods dealt with in the stratigraphical studies of each tomb. The tombs are placed, as accurately as possible, in chronological order also within the different sub-periods. This does not hold good for the L. C. III tombs.

M. C. III C	12	—	1	burial
L. C. I A	20, 21, 4 ^{I-II} , 8 ^I	—	5	burial groups
L. C. I B	8 ^{II} , 17 ^I , 2 ^I	—	3	» »
L. C. II A	17 ^{II} , 2 ^{II-V} , 13, 19, 3 ^I , 11 ^I	—	9	» »
L. C. II B	17 ^{III} , 3 ^{II} , 7 B, 7, 11 ^{II-IV} , 22, 6 ^{I-II}	—	10	» »
L. C. II C	18 S., 18 ^I , 11 ^V , 11 Dr., 10 ^{I-II} , 10 A, 18 ^{II}	—	8	» »
L. C. III	6 ^{III} , 7 A, 11 A, 14, 15, 16, 19 A	—	7	» »

After very humble beginnings in the Middle Cypriote III C period, the wealth and importance of the burial ground is in unbroken growth up to the end of Late Cypriote II C. There it reaches its acme in the second burial group of Tomb 18.

The Late Cypriote III period marks a break in the development. The type of tombs is changed, and the contents are very poor. Instead of rock-cut chamber tombs, occasionally covered by mounds of earth, and filled with rich finds, there come shaft tombs dug in the earth, sometimes even in the mounds of the old tombs, with few and simple tomb-gifts. The Levanto-Helladic pottery, so characteristic for the previous period, is entirely missing, and its place is taken by Bucchero and Plain White Wheel-made Wares of advanced types. The historical bearings of these facts will be discussed later on.

A comparison between these chronological results and the field map does not yield any evidence as regards the topographical development of the burial ground. The area excavated and examined by the Expedition is a small part of the total necropolis, but within this area there cannot be found any systematic distribution of tombs of different epochs to different parts of the necropolis. On the contrary, they are all intermingled with each other in a seemingly arbitrary way.

E. S.

A P P E N D I X



Fig. 216. Ajios Jakovos, Bronze Age Sanctuary,
Cylinder No. 12.



SCALE 1: 1.

Fig. 217. Ajios Jakovos, Inscription on the
cylinder.

1. Die Inschrift ist so zu lesen, wie sie auf dem Siegel steht, nicht wie sie auf dem Abdruck erscheint. Das ist nicht ungewöhnlich; cf. *Collection de Clercq, Catalogue, Tome 1, Cylindres orientaux (Ménant) Paris 1888 p. 196 nr. 360: Inscription de trois lignes d'un très beau travail; les caractères sont tracés sur le cylindre dans le sens direct de l'écriture et l'empreinte les donne nécessairement à l'envers. Ibid., p. 199 nr. 370: un cartouche de trois lignes d'écriture en caractères cunéiformes . . . tracés sur le cylindre dans le sens direct de la lecture; l'empreinte les présente retournés. Ebenso ibid. p. 200 nr. 371, p. 204 nr. 373, p. 216 nr. 386 bis.*
2. Die Form der Zeichen erinnert an die Amarnatafeln aus Phönizien, nähert sich aber der späteren assyrischen Schriftform.
3. Es sind fünf Zeichen, wie auf dem Siegel deutlich zu erkennen.
4. Am Anfange steht kein Determinativ für Personennamen. Aber dieses kommt ja überhaupt erst ungefähr in der Amarnazeit auf (cf. *Ur Excavations I nr. 155*). Die Annahme, dass wir einen Personennamen vor uns haben, ist natürlich und berechtigt.
5. Das erste Zeichen ist MI. Die Lesung Šil kommt weder in den Amarnatafeln noch in den hethitischen vor und ist auch hier kaum in Erwägung zu ziehen.
6. Das zweite Zeichen ist wie im Assyrischen und in den Amarnatafeln LA zu lesen (cf. den Brief des Königs von Alasia, *VAT 153, Schröder nr. 14 Z. 24 und Z. 9 am Ende*). Die Zeichen TE, APIN und SU, die im Hethitischen ähnlich geschrieben werden (cf. *Forrers Schrifttafel in der 41. Wissenschaftlichen Veröffentlichung der Deutschen Orient-Gesellschaft, p. 38 nr. 32 und 33, p. 39 nr. 100*) kommen hier nicht in Betracht.
7. Das dritte Zeichen kann nur TA sein. Auffallend ist freilich, dass der untere wagerechte Keil am Anfange so weit vorgerückt ist. Auch *VAT 1678, O. Schröder nr. 139, Z. 8* ist nicht ähnlich.

8. Das vierte Zeichen ist PI (uznu). Dass der untere Doppelkeil am Anfange etwas vorgerückt ist, findet sich oft in den Amarnatafeln aus Phönizien und Amurru; cf. z. B. VAT 1640, Schröder nr. 133 (aus Akko) Z. 15, 16, 20; *ibid* VAT. 334, Schröder nr. 137 Z. 13. Die Lesung des Zeichens ist hier am wahrscheinlichsten JA oder WA.
9. So weit wäre also die Lesung ziemlich sicher Mi-la-ta-ja (wa).
10. Das letzte Zeichen findet sich meines Wissens so nicht auf andern Inschriften. Es ist wohl eine Nebenform zu , indem der Schreiber die beiden oberen wagerechten Striche am Anfange nach oben gezogen hat, vielleicht aus technischen oder stilistischen Rücksichten, weil vier wagerechte Striche übereinander ihm nicht bequem waren. Dann ist es entweder TUR (cf. Schröder, Schrifttafel in den Vorderasiatischen Schriftdenkmälern der königl. Museen zu Berlin, Heft XII, 2 p. 75 (Lpz. 1915) nr. 77; Forrer p. 35 nr 286) oder LUB wie im klassischen Assyrisch zu lesen. Das letztere Zeichen kommt in den Amarnabriefen nicht vor und hat im Hethitischen ganz andere Formen (Forrer p. 32 nr. 200, p. 30 nr. 167). Sonst läge es der Form nach am nächsten. — Der Vorschlag, das Zeichen als eine Nebenform zu IN oder LUGAL aufzufassen, ist meiner Meinung nach abzuweisen.
11. Es scheint, als ob der Gravör das letzte Zeichen etwas abgerückt hat, um anzudeuten, dass es nicht phonetisch zu lesen und kein Teil des eigentlichen Namens ist, sondern eine Art Titel oder Standesbezeichnung, wie sonst am Schlusse von Siegellegenden LUGAL (König) oder DUB-SAR (Schreiber) oder DAM-QAR (Banquier) etc. steht.
12. Das Zeichen TUR hat die Bedeutung mâru «Sohn» oder şihru «klein». Mâr «Sohn» ist bei den Hethitern zur stehenden Bezeichnung der königlichen Prinzen geworden (cf. Forrer, Boghazköi-Texte in Umschrift, Bd. II, Lpz. 1926 p. 7*). Şihru würde hinter einem Namen «der Jüngere» bedeuten können. Also «Milataja der Prinz» oder «der Jüngere».
13. Dagegen das Zeichen LUB hat die Bedeutung nâru, «Sänger» oder «Musiker», was als Berufsangabe hinter dem Eigennamen auch nicht übel passen würde.
14. Der Name «Milataja» ist vielleicht ein Nomen relativum (Nisbe). Welchem Sprachgebiete er angehört, vermag ich nicht zu sagen.
15. Sollte gegen alle Wahrscheinlichkeit der Name doch «Şillataja» zu lesen sein, so hätten wir einen semitischen Eigennamen vor uns, der I. Chron. 8, 20; 12, 20 (Zeit Davids) in der Form Şilletaj vorkommt. Vergl. Şillâ Gen. 4, 19 und Şillâ, Harper Letters 702 R 7, 843 R 17; 928, 6; 1111, 2; 1131, 21; 1204 R 1; 1233, 9; 1255, 15, R1, 13; 1256 R 6, 1430 R 2; Tallqvist, Assyrian Personal Names, p. 206, 319 f, 303.

Stockholm, d. 5. Dez. 1933.

DR. WILH. RIEDEL.

N O T E S

PETRA TOU LIMNITI

- | | Page |
|--|------|
| 1 <i>Scenska Orientsällskapetets årsbok</i> , 1925, pp. 5 ff.; <i>The Antiquaries' Journal</i> , 1926, pp. 54 ff. | .. |

LAPITHOS

THE NECROPOLIS AT VRYSI TOU BARBA

- | | |
|--|----|
| 1 Myres and Ohnefalsch-Richter, <i>A Catalogue of the Cyprus Museum</i> , Oxford 1899, p. 7 | 3. |
| 2 Ohnefalsch-Richter, M., <i>Kypros, die Bibel und Homer</i> , Berlin 1893, p. 300 and Pl. XXXVI | 35 |
| 3 Gjerstad, E., <i>Studies on Prehistoric Cyprus</i> , Uppsala 1926, pp. 57 ff.; 73 | 33 |
| 4 Gjerstad, E., <i>op. cit.</i> , p. 8. | 35 |

THE NECROPOLIS AT KYLISTRA AND AJIA ANASTASIA

- | | |
|---|-----|
| 1 Markides, M., <i>Excavation Report MS.</i> ; Gjerstad, E., <i>op. cit.</i> , p. 8 | 165 |
| 2 Gjerstad, E., <i>op. cit.</i> , pp. 279 ff. | 162 |
| 3 <i>Ibid.</i> | 16. |

AJIOS JAKOVOS

- | | |
|--|-----|
| 1 Gjerstad, E., <i>op. cit.</i> , p. 9 .. | 302 |
| 2 Duncan, J. Garrow, <i>Corpus of Palestinian Pottery</i> , London 1930, Pl. 31, K. | 376 |

NITOVIKLA

- | | |
|---|-----|
| 1 Hogarth, D., <i>Devia Cypria</i> , London, 1899, p. 78; Gjerstad, E., <i>op. cit.</i> , pp. 10 ff. | 371 |
| 2 Gjerstad, E., <i>op. cit.</i> , p. 11 | 371 |

KOUNTOURA TRACHONIA

- | | |
|--|-----|
| 1 Svoronos, J. N., <i>Tiς νομισματικὴ τοῦ ἀγίου τῶν Ἱεροζουχίων</i> , IV, (Deutsche Übers.). Athen 1908, pp. 177—179 | 46c |
|--|-----|

ENKOMI

- | | |
|---|-----|
| 1 Murray, A. S., <i>Excavations in Cyprus</i> , London 1900, p. 3. | 467 |
| 2 For the interpretation of the scene, I refer to Prof. M. P. Nilsson's paper: <i>Zeus mit der Schicksalswaage auf einer cyprisch-mykenischen Vase</i> (Bull. de la Soc. Royale des lettres de Lund, 1932—33, pp. 29 ff.) | 543 |



